



# 4 AND 6 COLUMN HIGH REVEAL ASSEMBLY GUIDE

Page 1

Questions?  
**888.373.6057**

or visit  
**wineracksamerica.com**

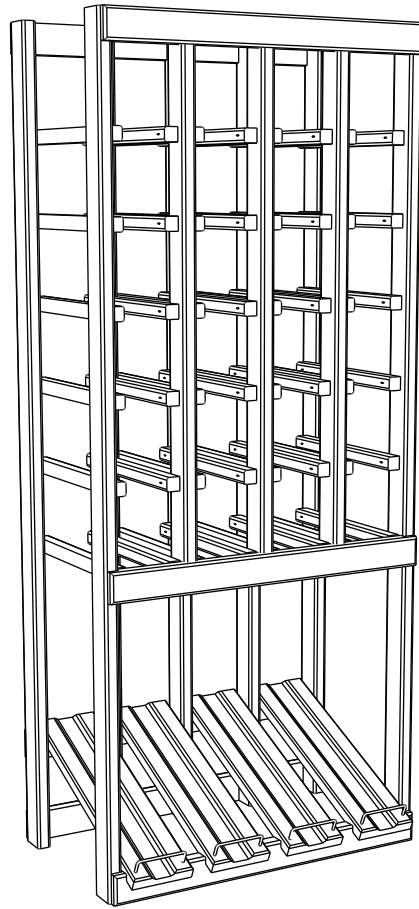

## PACKAGE CONTENTS

\*All models follow the same assembly procedure varying only in the number of middle ladders your rack will require.

\*Please verify that you have the correct number of parts before proceeding.  
Depending on the model you purchased, your bundle should contain the following:

END LADDER (X2)

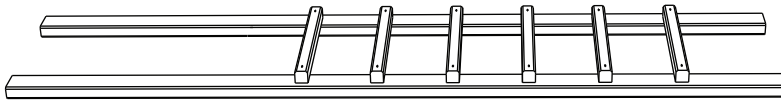

DISPLAY TRAYS

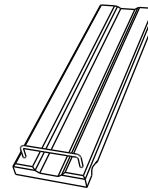

MIDDLE LADDERS

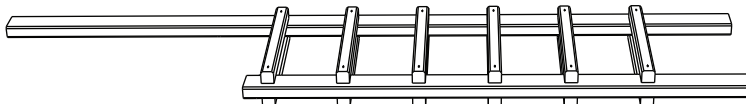

SIDE DISPLAY PIECE  
(OPTIONAL)

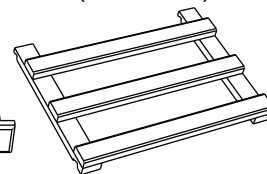

STANDARD CONNECTOR (X3)



REVEAL CONNECTOR (X1)

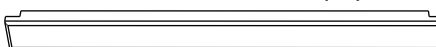

SCREWLESS CONNECTOR (X2)



WOOD PUTTY



FINISH NAILS



WOOD SCREWS

## TOOLS FOR ASSEMBLY

### Required

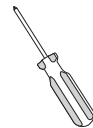

Screwdriver



Wood Glue

### Suggested

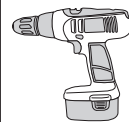

Cordless Drill



Finish Nailer

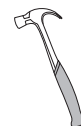

Hammer

+



Nail Setter



# 4 AND 6 COLUMN HIGH REVEAL ASSEMBLY GUIDE

Questions?  
**888.373.6057**

or visit  
**wineracksamerica.com**

Page 2

1. Find an open, flat area in which to work. Carefully remove all components from the box and remove banding with a utility knife. Check the parts list to verify package contents.
2. Arrange the end ladders on the floor so that the bottle support pieces face one another. Align the large gaps on each end ladder. The end with the larger gap is the bottom of your rack. Attach a standard connector to the top and bottom of your rack using the screws provided. Make sure the connectors are flush with the top and bottom of your rack. (figure 1)

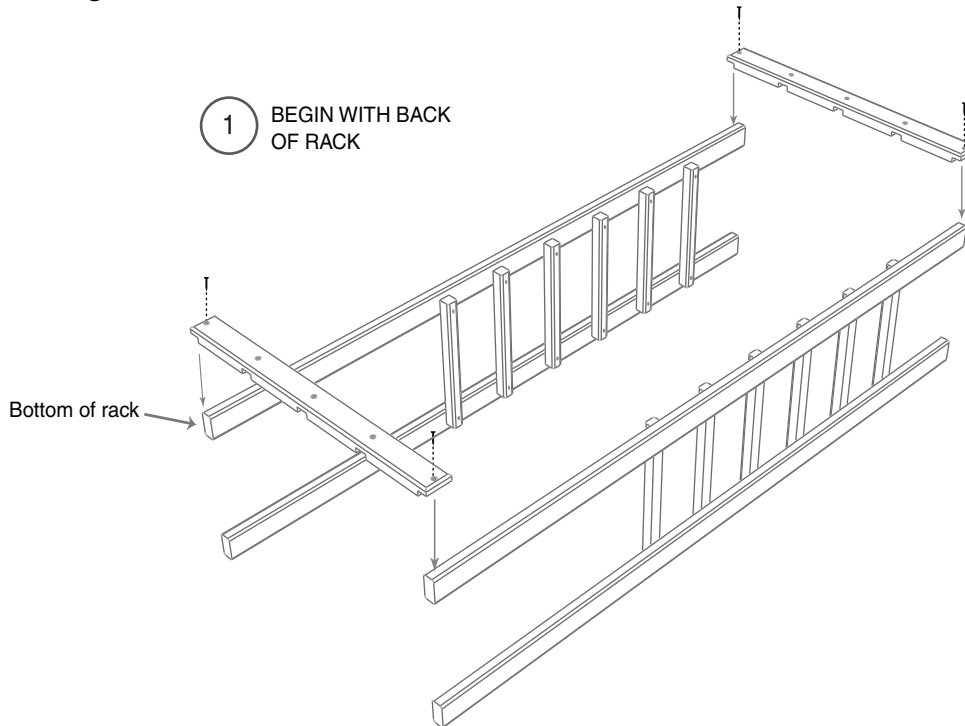

- 
3. Insert the middle ladders and finish securing the top & bottom connectors using the screws provided. (figure 2)

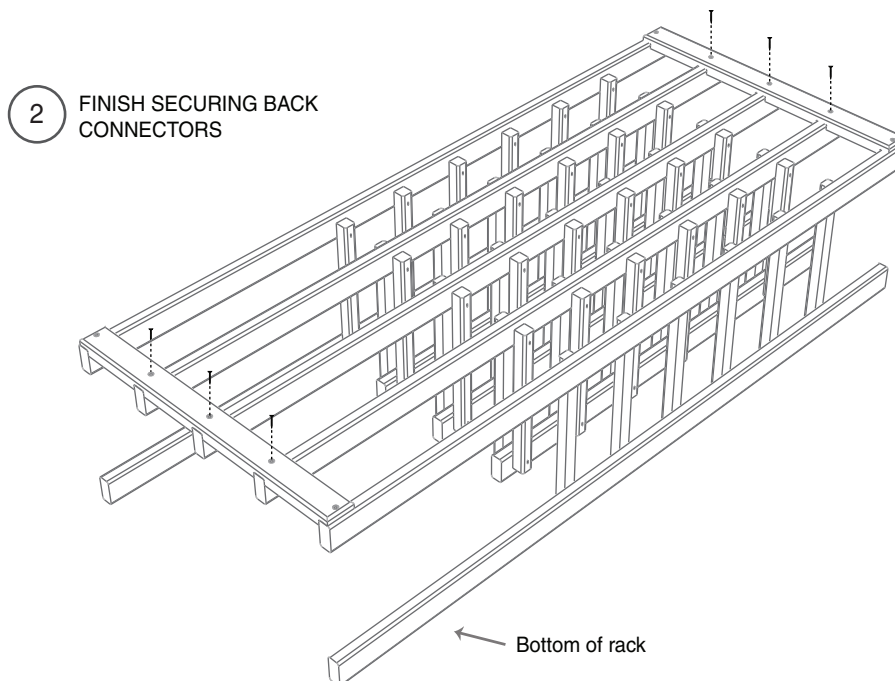

4. Secure the remaining standard connector so that the top of the connector is 6" from the bottom of the rack. (figure 3)

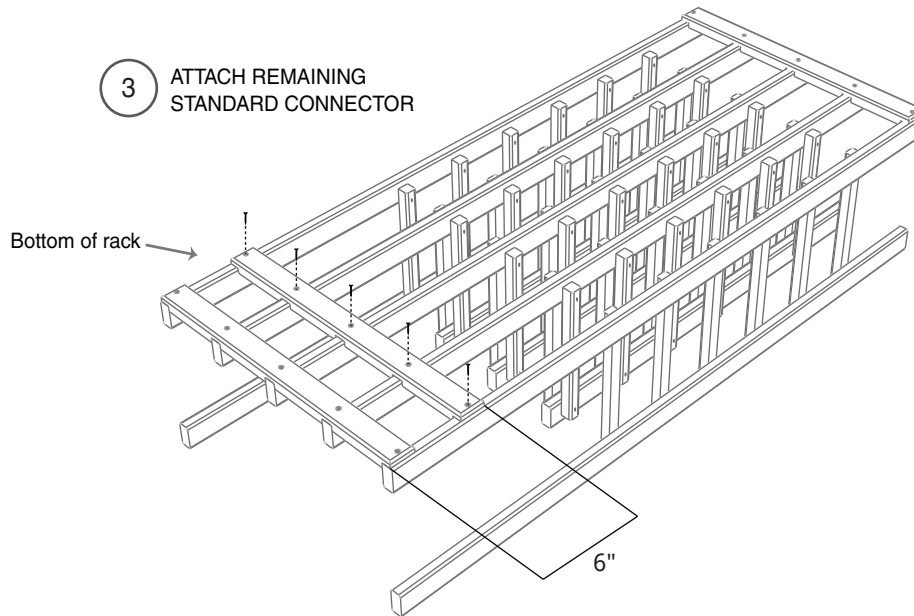

5. Flip the rack over and attach a screwless connector to the top of the rack (figure 4). Attach the remaining screwless connector so that the bottom of the connector aligns with the bottom of the middle ladder risers (figure 5). Secure the bottom reveal connector to the bottom of the two end ladders (figure 6).

High Reveal Racks are designed to show no visible hardware on the front of the rack. Use one of these following methods to install the screwless connectors:

- A** For no visible hardware, add wood glue to the inside of each connector notch. Place the connector on your rack and carefully press each notch into place. Hold until glue is dry. (figure A)
- B** For minimal visible hardware, add wood glue to the inside of each connector notch. Place the connector on your rack and carefully press each notch into place. Hold until glue is dry. For added support, use a finish nailer to attach the connector to the two end ladders and one middle ladder. (figure B)
- C** For a professional installation, secure the connectors using a finish nail gun to drive a nail through the connector into each vertical ladder. If you do not have a finish nail gun, drive one of the provided finish nails into each vertical ladder until it is flush. Then, countersink the nail using a nail setter until the head of the nail is about 1/16" below the surface of the wood. Use provided wood putty to fill nail holes. (figure C)

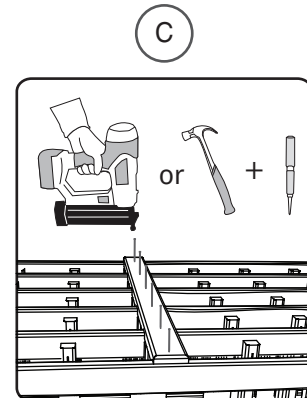
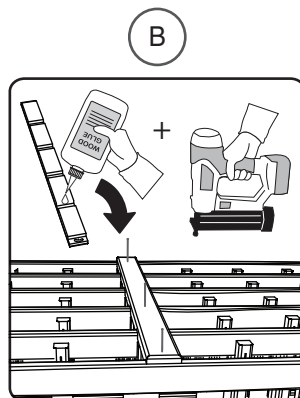
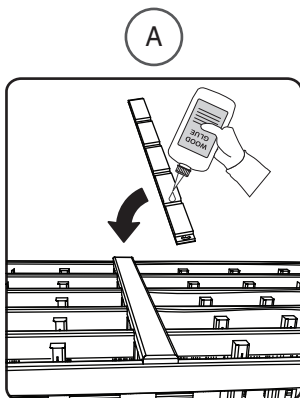



# 4 AND 6 COLUMN HIGH REVEAL ASSEMBLY GUIDE

Page 4

Questions?  
**888.373.6057**

or visit  
**wineracksamerica.com**

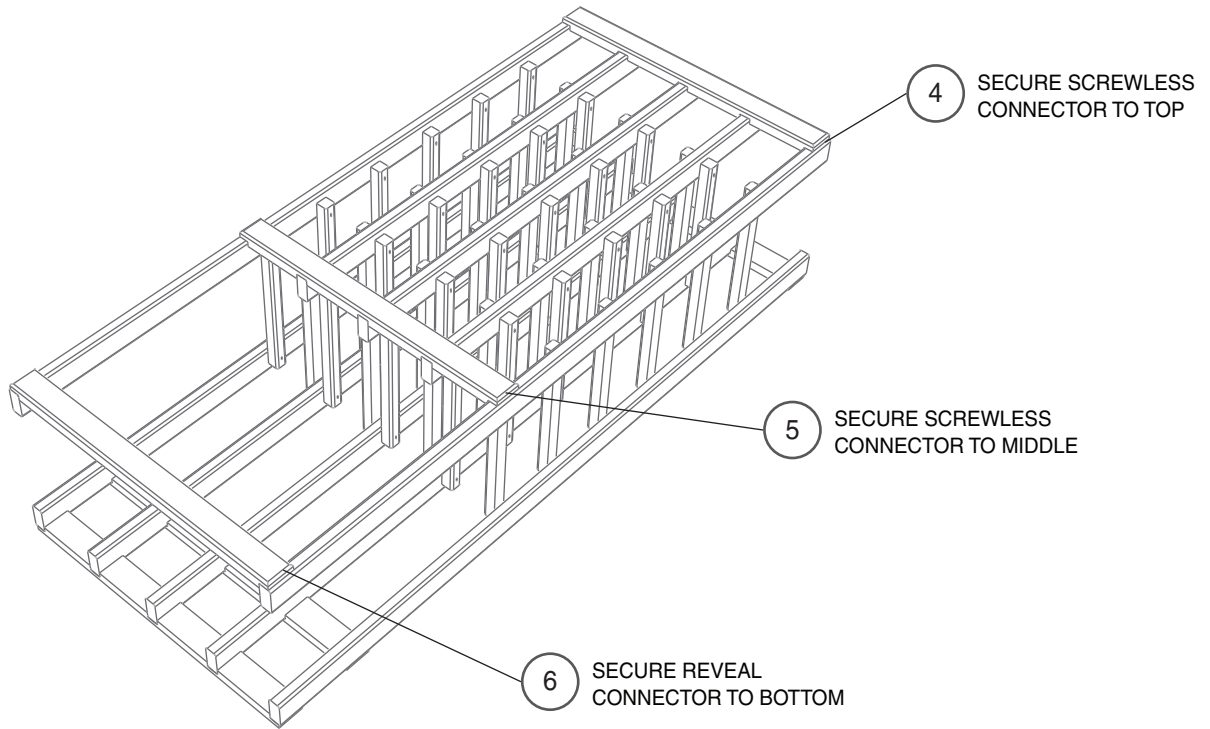

- 
6. Stand your rack upright. Secure the display trays to the rack by adding a bead of wood glue to each of the two grooves on the back of the tray. Set the tray into place so that grooves rest on the lower reveal connector and the standard connector on the back of the rack. (figure 7)

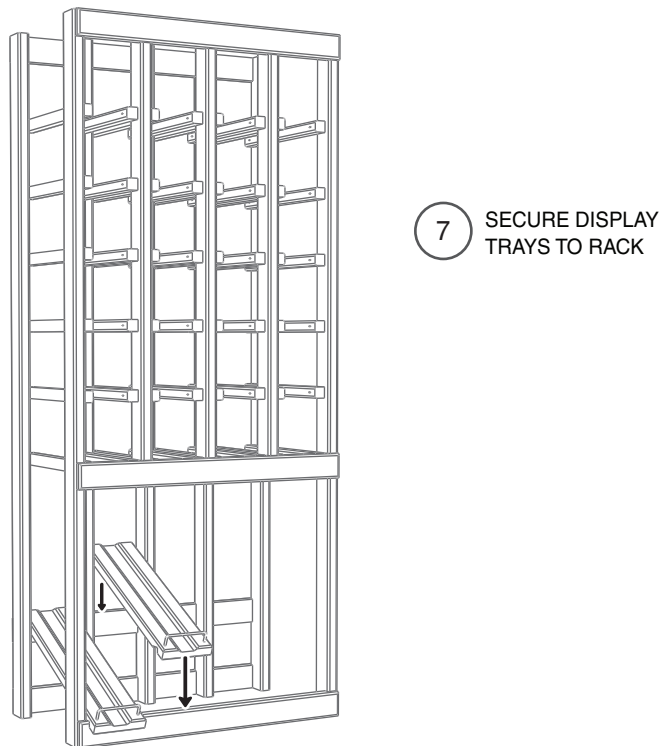



# 4 AND 6 COLUMN HIGH REVEAL ASSEMBLY GUIDE

Questions?  
**888.373.6057**

or visit  
**wineracksamerica.com**

Page 5

7. If you purchased a Side Display High Reveal Rack, secure the side display piece to the rack by adding a bead of wood glue to each of the two grooves on the side display end pieces. Set the side display piece into place so that grooves rest on the lower reveal connector and the standard connector on the back of the rack. (figure 8)

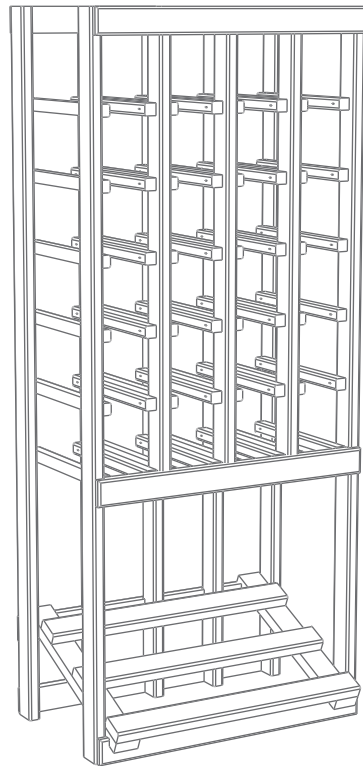

8 SECURE SIDE  
DISPLAY TO RACK  
(OPTIONAL)

8. That's it!! Place on top of your base rack of choice and enjoy. Pair with other racks for a true wine cellar look.



We would love to see your wine racks in use! Please feel free to send any photos of your racks to [photos@wineracksamerica.com](mailto:photos@wineracksamerica.com)

Once again, thank you for your business. Remember, customer service is available to answer any questions Monday-Friday 7:00 am - 5:00 pm MST. Please feel free to contact us for any wine storage needs.

360 North 700 West Suite F • North Salt Lake, UT 84054  
(toll free) 888-373-6057  
(fax) 801-936-0534

**WINERACKSAMERICA.COM**