

Spezifikationen Tamara

Ecksofa klein	390 x 226 cm
Ecksofa gross	308 x 362 cm
Doppelbett	272 x 236 cm
Sitz-Höhe	40 cm
Lehnen-Höhe	Modul 70 cm, mit Kissen 92 cm
Textilien	ÖKOTEX Standard 100 zertifiziert
Material Rahmen	Massivholzrahmen aus Buche

Stoff-Pflege

Oberflächliche Verschmutzungen wie Krümel kannst du mit dem Staubsauger entfernen. Achte darauf, ihn nicht in den Stoff zu drücken sondern mit kleinem Abstand darüber zu führen. Hartnäckige Rückstände mit einer weichen Bürste in Strichrichtung behandeln.

Ecksofa klein

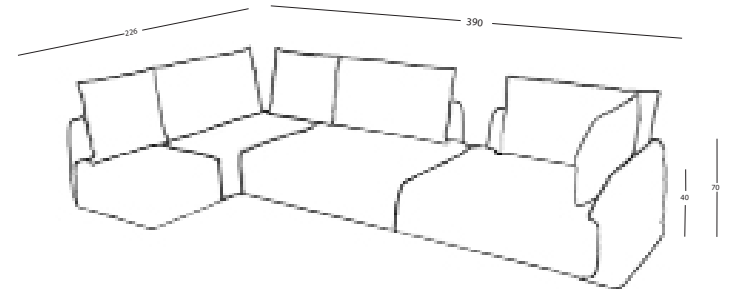

Doppelbett

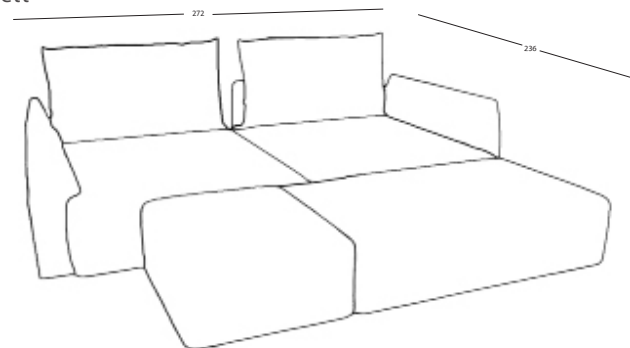

Ecksofa gross

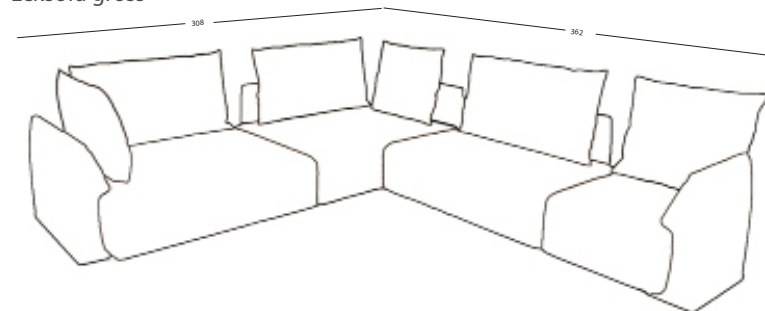

Einzelne Elemente Tamara

Sitzelemente

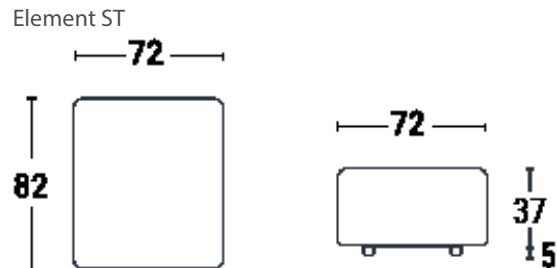
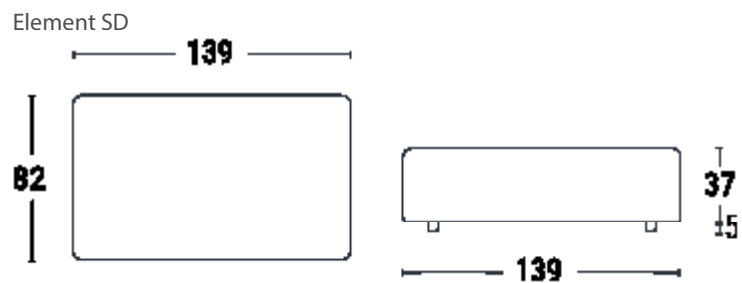
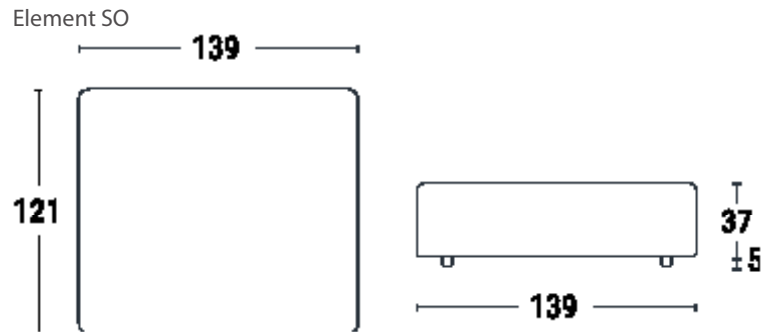

Rückenlehnen

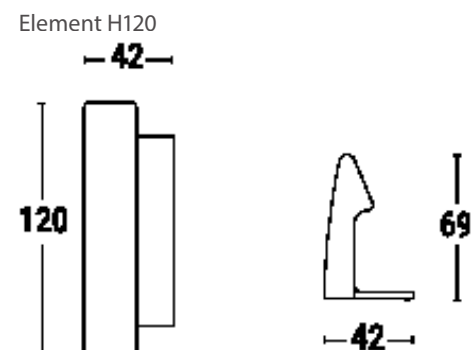
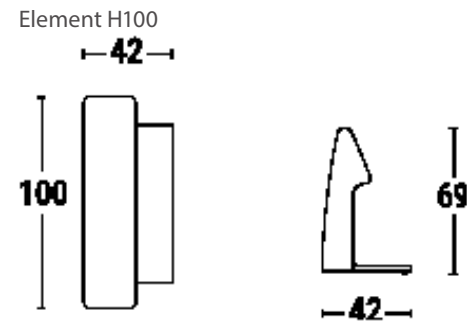
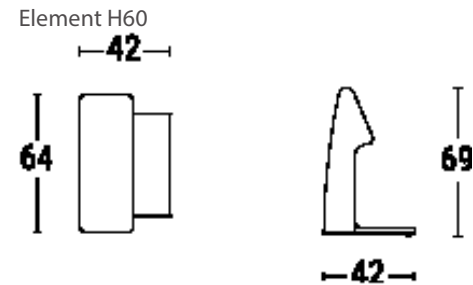

Kissen

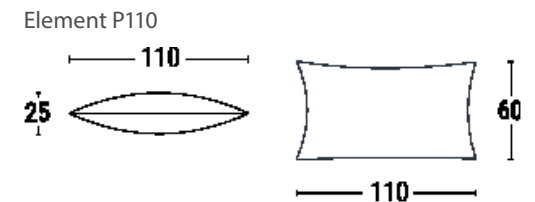
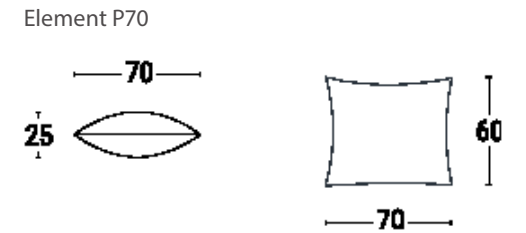

Spécifications Tamara

Canapé d'angle petit	390 x 226 cm
Canapé d'angle grand	308 x 362 cm
Lit double	272 x 236 cm
Hauteur d'assise	40 cm
Hauteur du dossier	Module 70 cm, avec coussin 92 cm
Textiles	Certifié ÖKOTEX Standard 100
Matériau du cadre	Cadre en bois massif de hêtre

Entretien des tissus

Les salissures superficielles, comme les miettes, peuvent être éliminées à l'aide d'un aspirateur. Veille à ne pas l'enfoncer dans le tissu mais à le passer à une petite distance. Les résidus tenaces doivent être traités avec une brosse douce dans le sens du poil.

Canapé d'angle petit

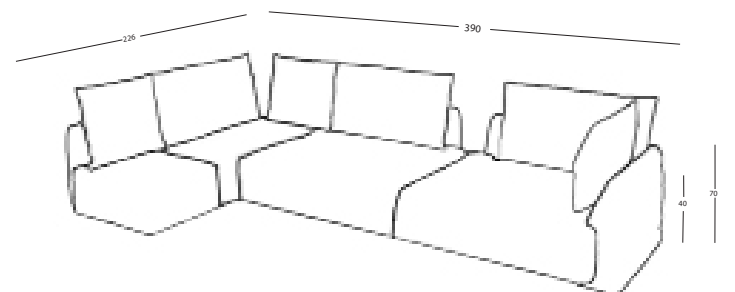

Lit double

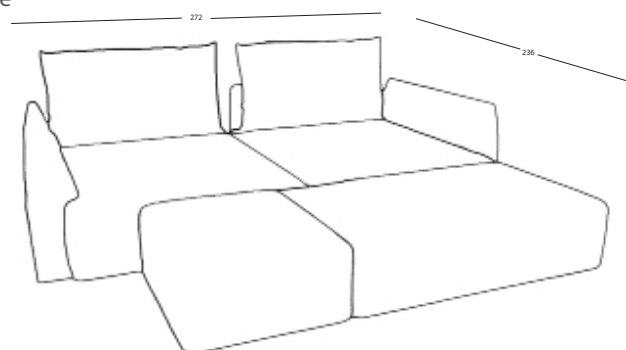

Canapé d'angle grand

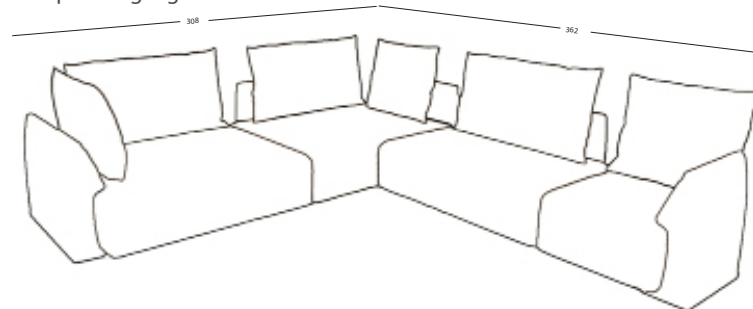

Éléments individuels Tamara

Éléments de siège

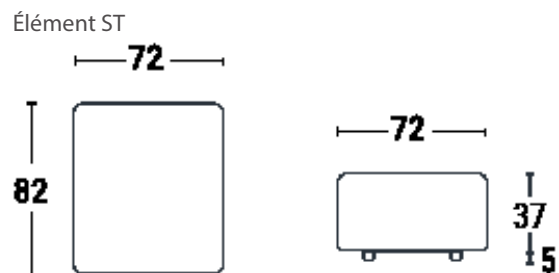
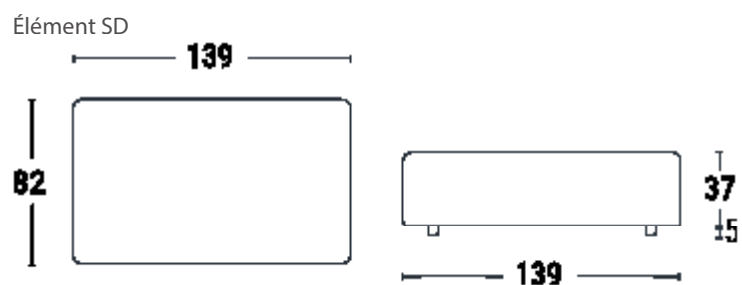
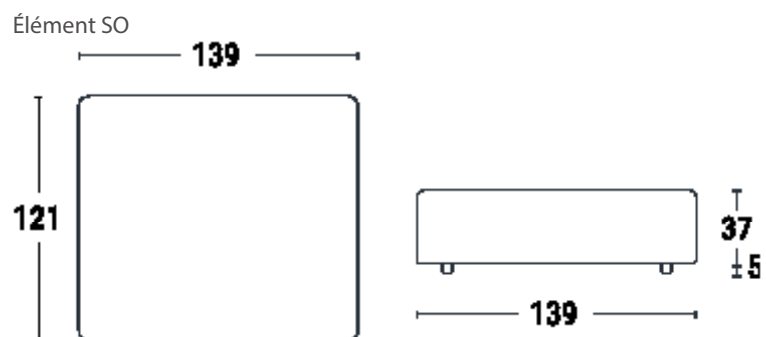

Dossiers

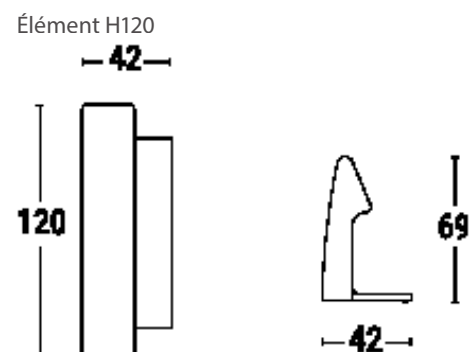
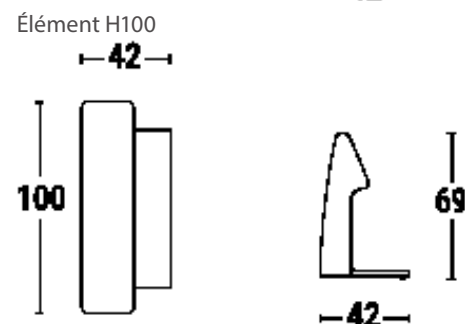
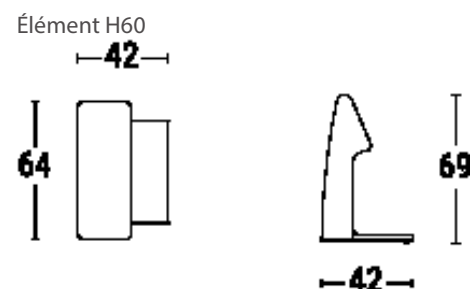

Coussins

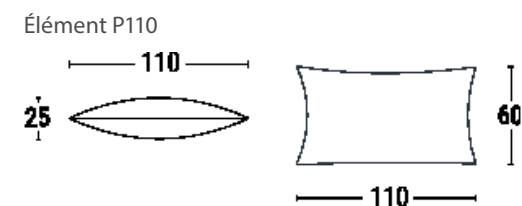
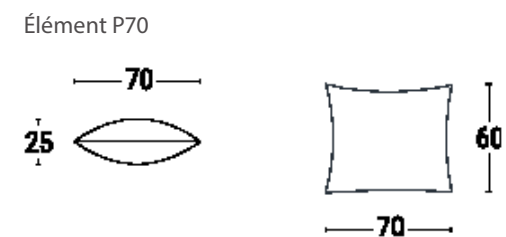

Specifiche Tamara

Divano angolare piccolo	390 x 226 cm
Divano angolare grande	308 x 362 cm
Letto matrimoniale	272 x 236 cm
Altezza del sedile	40 cm
Altezza dello schienale	Modulo 70 cm, con cuscino 92 cm
Tessile	Certificato ÖKOTEX Standard 100
Materiale telaio	Struttura in legno di faggio massiccio

Cura del tessuto

È possibile rimuovere lo sporco superficiale, come le briciole, con un aspirapolvere. Fare attenzione a non spingere l'aspirapolvere all'interno del tessuto, ma a passarci sopra a una piccola distanza. Trattare i residui più ostinati con una spazzola morbida nella direzione del tratto.

Divano angolare piccolo

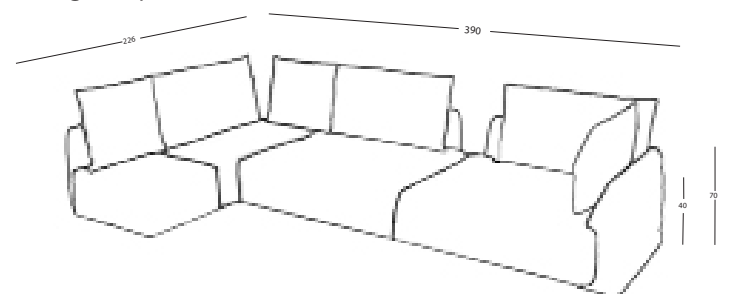

Letto matrimoniale

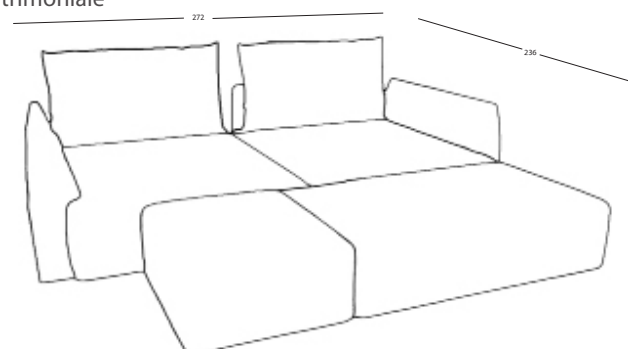

Divano angolare grande

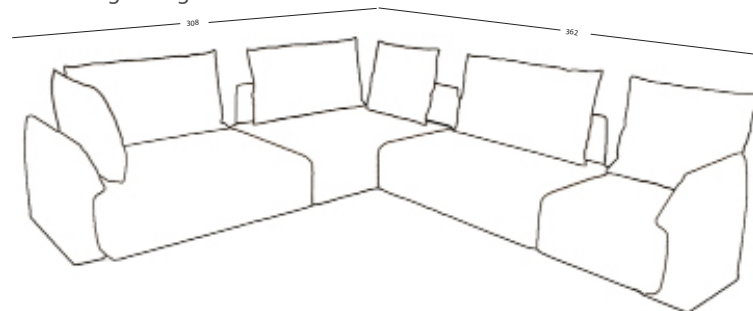

Elementi individuali Tamara

Elementi di seduta

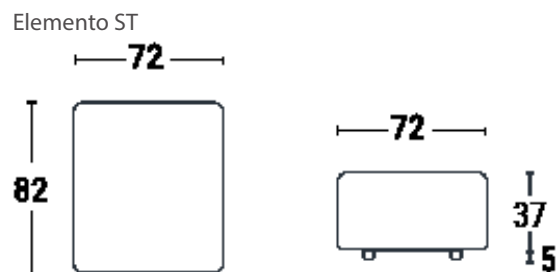
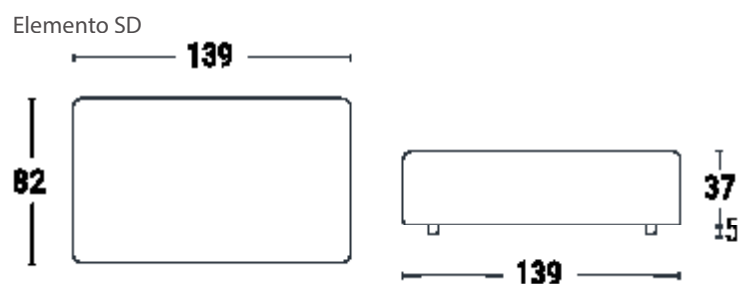
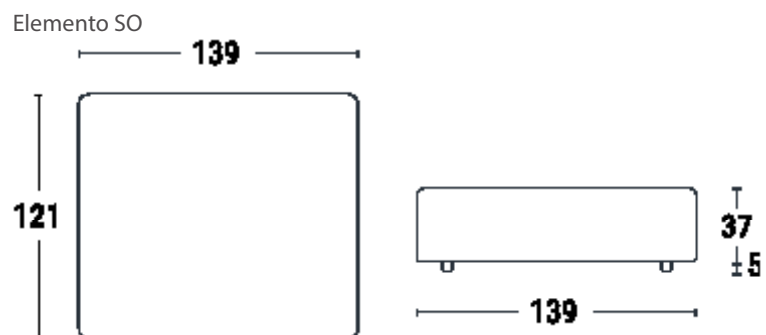

Schienali

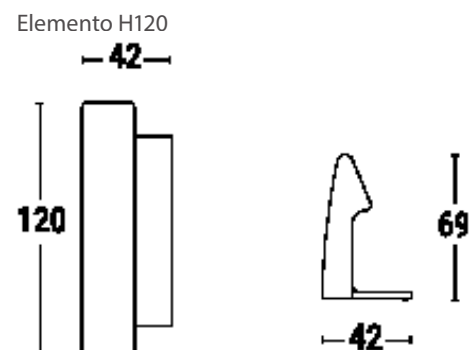
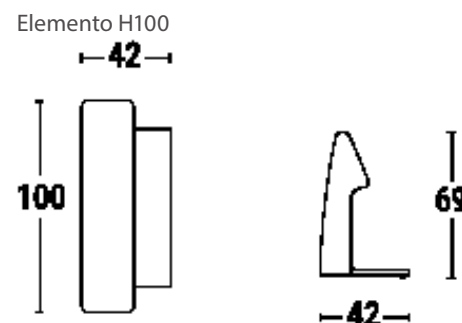
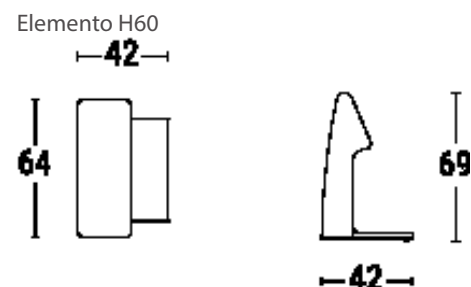

Cuscino

