

Spezifikationen Katrina

Ecksofa	332 x 208 cm
Doppelbett	193 x 193 cm
Sitz-Höhe	40 cm
Lehnen-Höhe	Modul 70 cm, mit Kissen 92 cm
Textilien	ÖKOTEX Standard 100 zertifiziert
Material Rahmen	Massivholzrahmen aus Buche
Verbindungs-Elemente	Klett-Verbindungen, die alle Elemente zusammenhalten

Stoff-Pflege

Oberflächliche Verschmutzungen wie Krümel kannst du mit dem Staubsauger entfernen. Achte darauf, ihn nicht in den Stoff zu drücken sondern mit kleinem Abstand darüber zu führen. Hartnäckige Rückstände mit einer weichen Bürste in Strichrichtung behandeln.

Zwei fünfeckige Elemente



Zwei viereckige Elemente

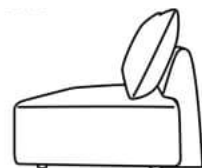

Ecksofa

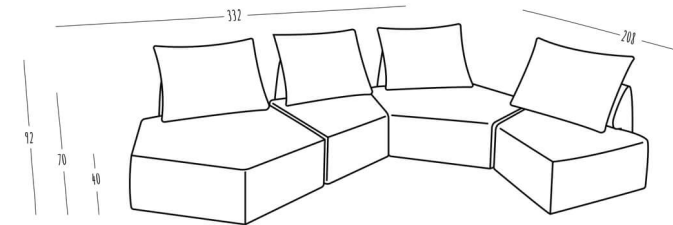

Zwei Zweisitzer

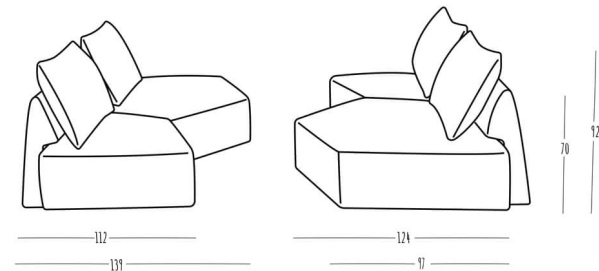

Doppelbett

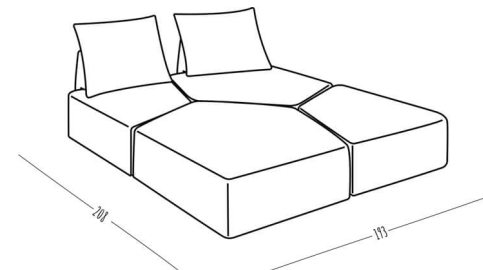

LIVOM

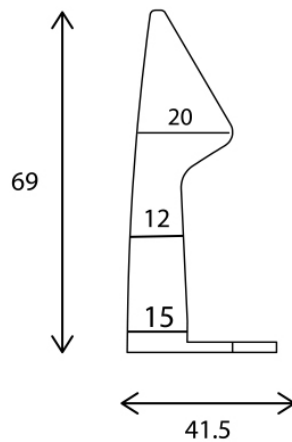
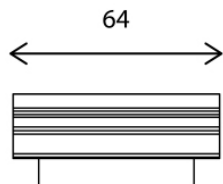

Rückenlehne

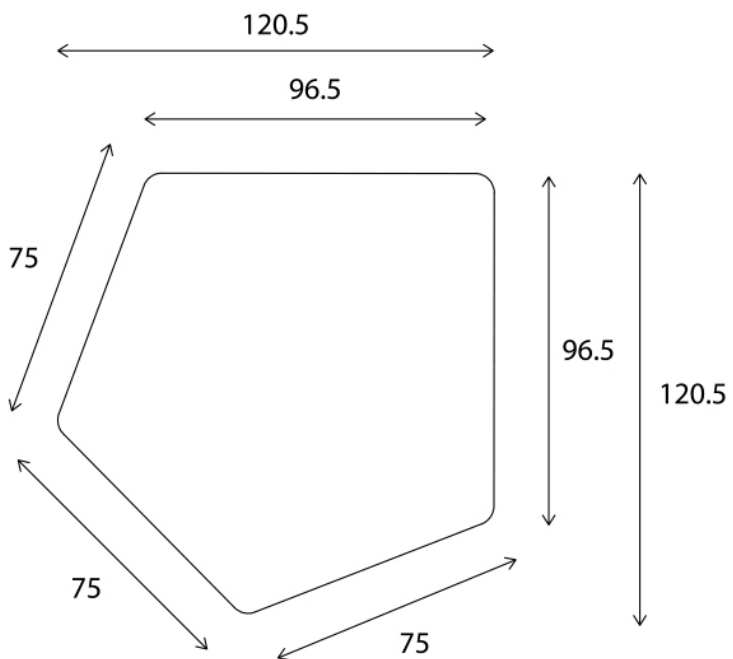

grosses Element

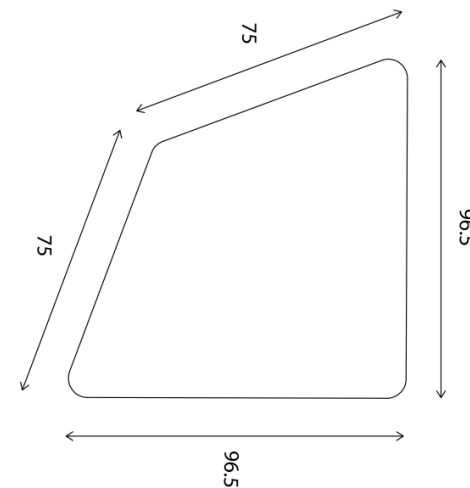

kleines Element

Spécifications Katrina

Canapé d'angle	332 x 208 cm
Grand lit double	193 x 193 cm
Hauteur de l'assise	40 cm
Profondeur de l'assise	Module 70 cm, avec coussin environ 92 cm
Textiles	Certifié ÖKOTEX Standard 100
Matériau des pieds du canapé	Hêtre (Europe), Bois massif
Éléments de connexion	Des assemblages par velcro qui relient tous les maintiennent les éléments

Entretien des tissus

Tu peux éliminer les salissures superficielles comme les miettes avec un aspirateur. Veille à ne pas l'enfoncer dans le tissu mais à le passer à une petite distance. Traiter les résidus tenaces avec une brosse douce dans le sens du poil.

Deux éléments pentagonaux



Deux éléments quadrangulaires

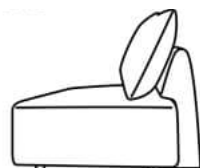

Canapé d'angle

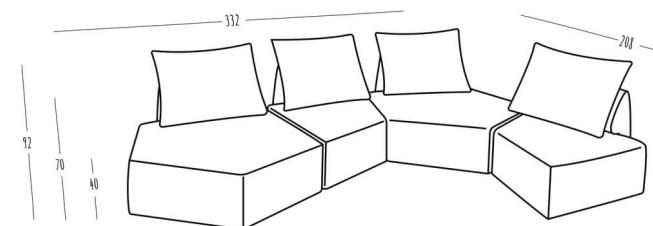

Deux places

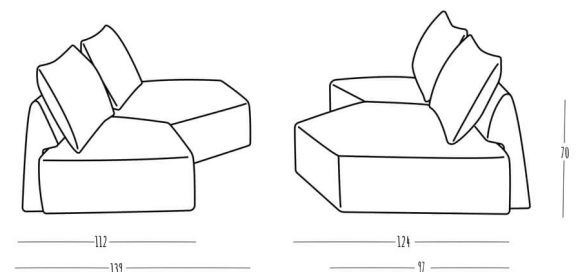

Lit double

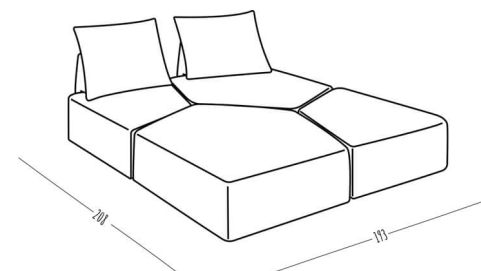

LIVOM

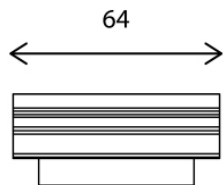

Dossier

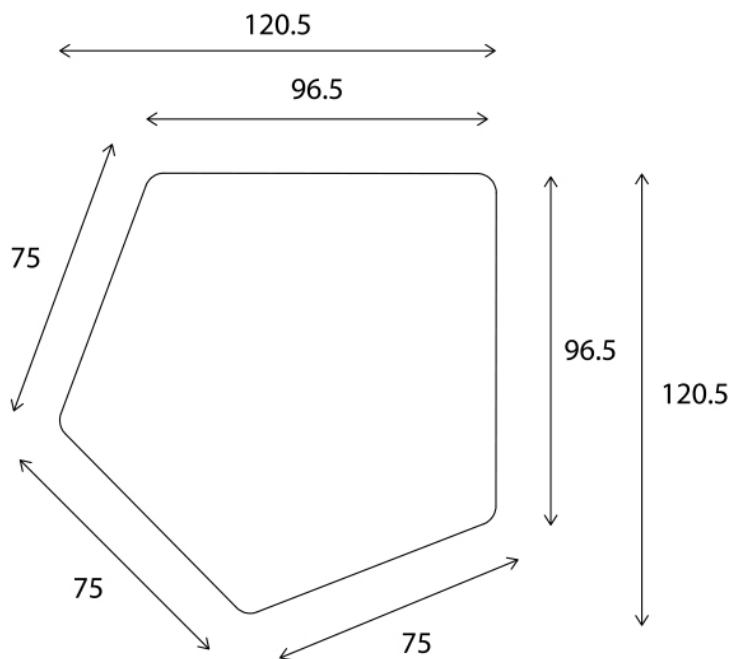
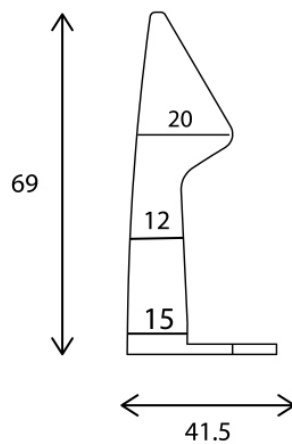

grand élément

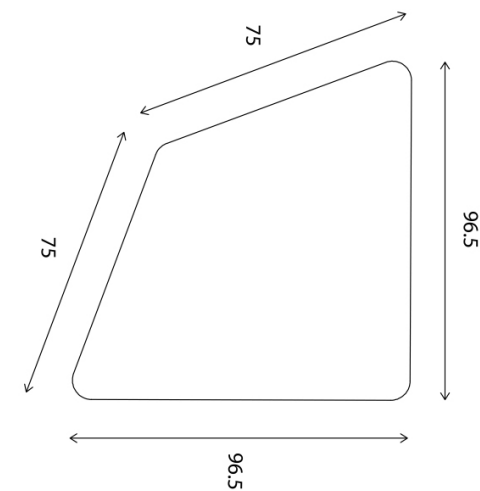

kleines Element

Specifiche Katrina

Divano angolare	332 x 208 cm
Letto matrimoniale grande	193 x 193 cm
Altezza della seduta	40 cm
Profondità della seduta	Modulo 70 cm, con cuscino circa 92 cm
Tessili	Certificato ÖKOTEX Standard 100
Materiale gambe divano	Faggio, legno massello
Elementi di connessione	Collegamenti in velcro che tengono tutti elementi insieme

Cura del tessuto

È possibile rimuovere lo sporco superficiale, come le briciole, con un aspirapolvere. Assicuratevi di non premerlo nel tessuto, ma di passarlo a breve distanza. I residui più ostinati possono essere rimossi con una spazzola morbida in direzione del pelo.

Due elementi pentagonali



Due elementi quadrangolari

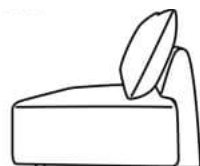

Divano angolare

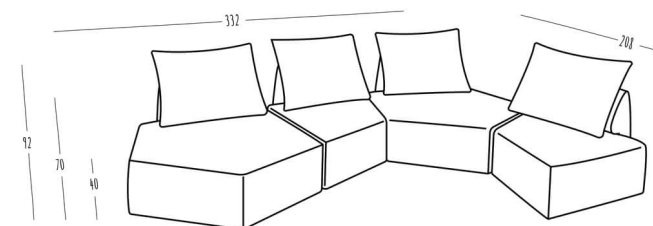

Due biposto

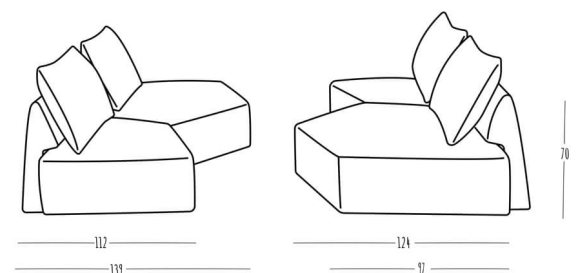

Letto doppio

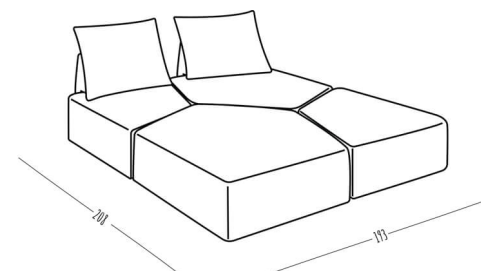

LIVOM

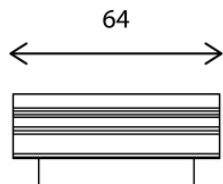

Schienale

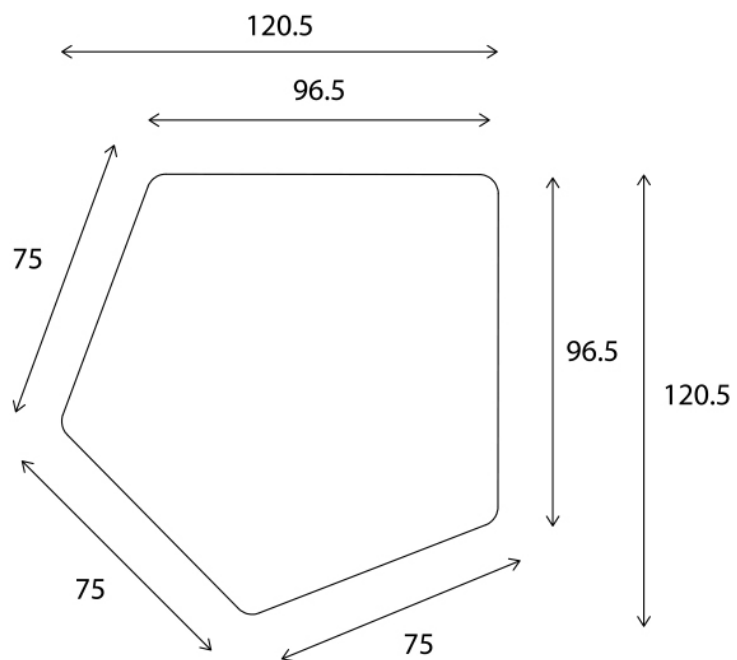
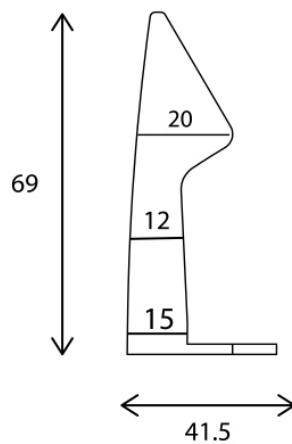

elemento grande

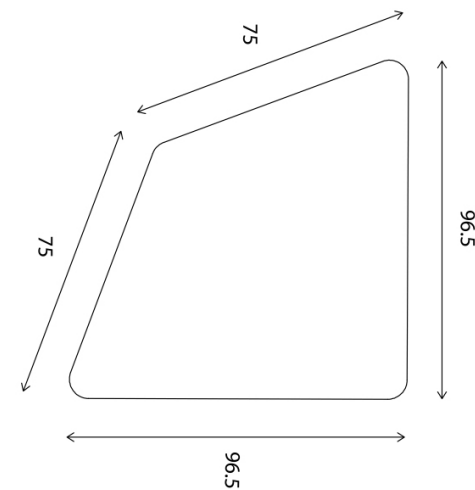

elemento piccolo