

Spezifikationen Amelie

Ecksofa	283 x 173 cm
Gerades Sofa	346 x 110 cm
Doppelbett	280 x 232 cm
Sitz-Höhe	39 cm
Lehnen-Höhe	Modul 59 cm, mit Kissen 94 cm
Textilien	ÖKOTEX Standard 100 zertifiziert
Stauraum	Grosser Stauraum unter den Armlehnen
Material Sofa-Beine	Buche, Massivholz

Stoff-Pflege

Oberflächliche Verschmutzungen wie Krümel kannst du mit dem Staubsauger entfernen. Achte darauf, ihn nicht in den Stoff zu drücken sondern mit kleinem Abstand darüber zu führen. Hartnäckige Rückstände mit einer weichen Bürste in Strichrichtung behandeln.

Ecksofa

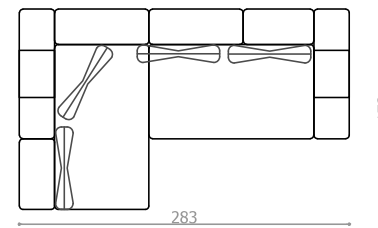

Ecksofa mit Ottomane

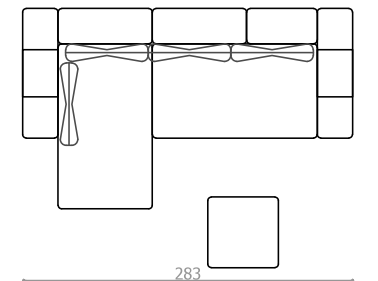

Gerades Sofa

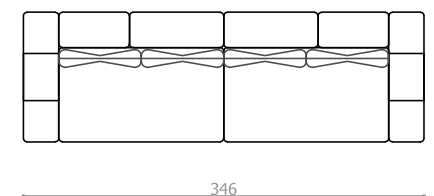

Doppelbett

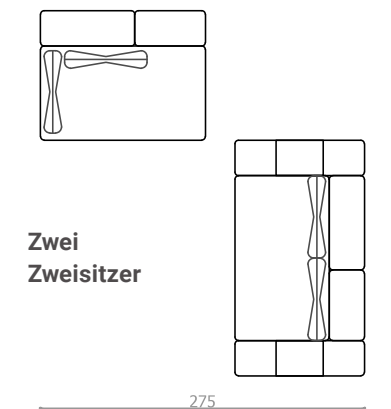
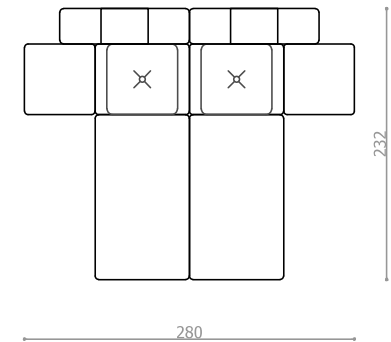

Sofa-Elemente Amelie

Element A Variationen

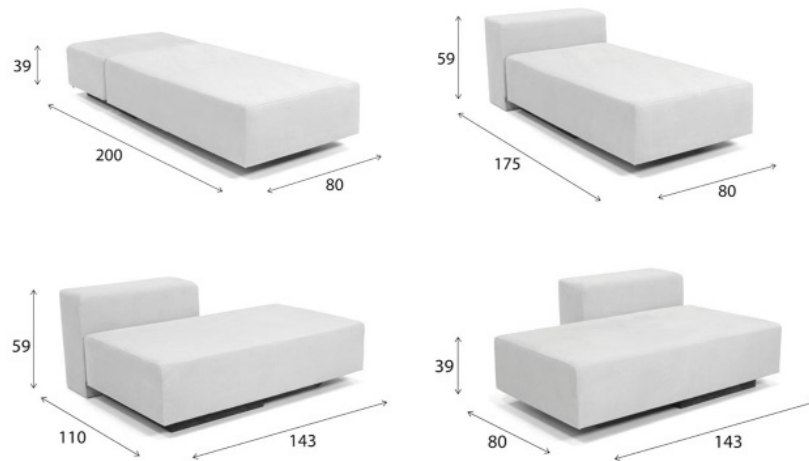

Element C Variationen

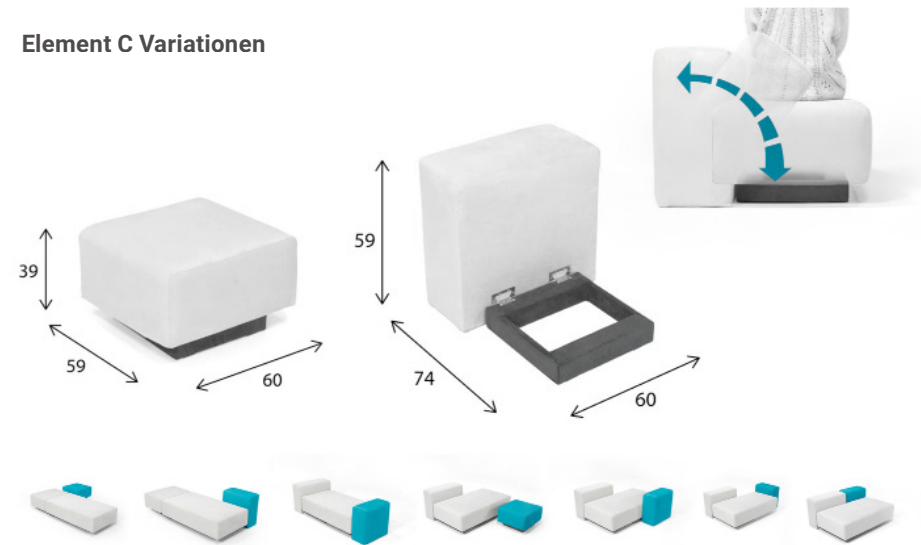

Element B



Element D
Stauraum

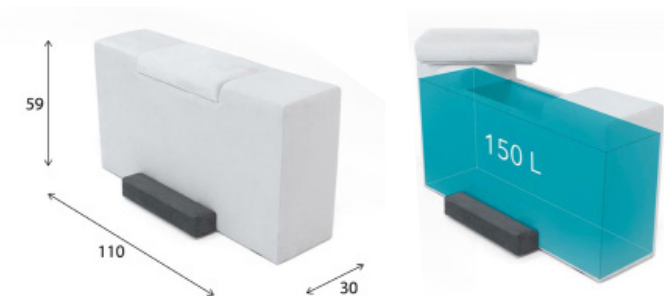

Spécifications Amelie

Canapé d'angle	283 x 173 cm
Sofa droit	346 x 110 cm
Grand lit	280 x 232 cm
Hauteur de l'assise	39 cm
Hauteur de dossier	Module 59 cm, avec coussin environ 94 cm
Textiles	Certifié ÖKOTEX Standard 100
Espaces de rangement	Grand espace de rangement sous les accoudoirs
Matériau des pieds du canapé	Hêtre (Europe), Bois massif

Entretien des tissus

Les salissures superficielles, comme les miettes, peuvent être éliminées à l'aide d'un aspirateur. Veillez à ne pas l'enfoncer dans le tissu, mais à le passer à une petite distance. Traiter les résidus tenaces avec une brosse douce dans le sens du poil..

Canapé d'angle

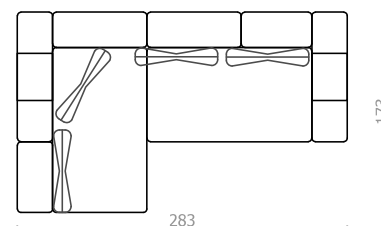

Canapé d'angle et Ottomane

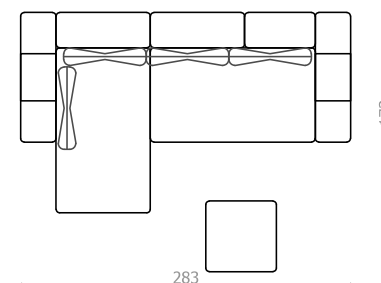

Canapé droit

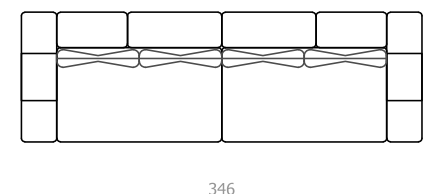

Lit double

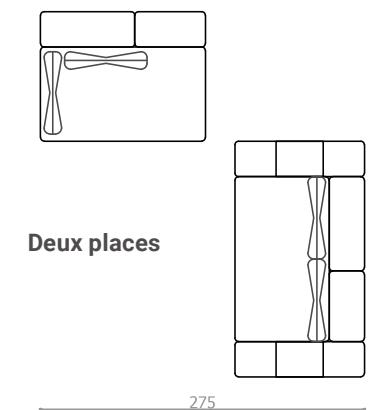
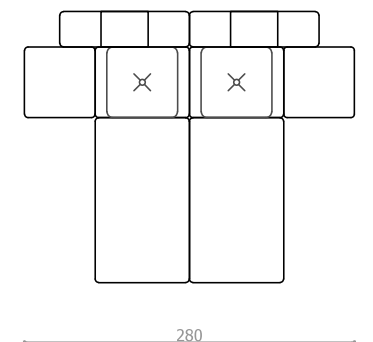

Éléments de canapé Amelie

Variations de l'élément A

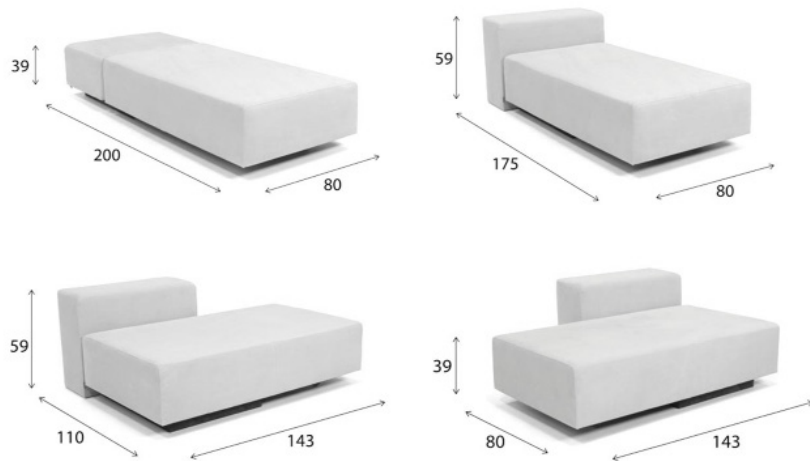

Variations de l'élément C

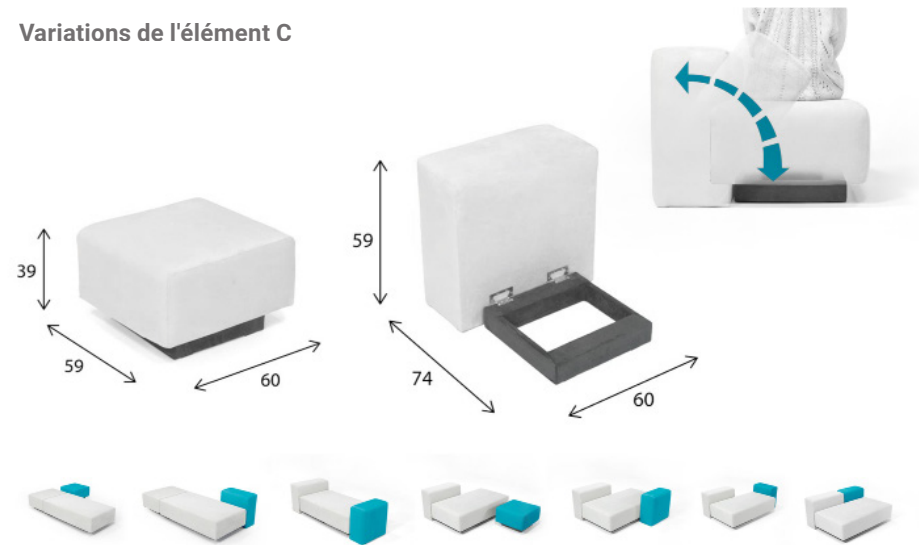

Élément B



Élément D

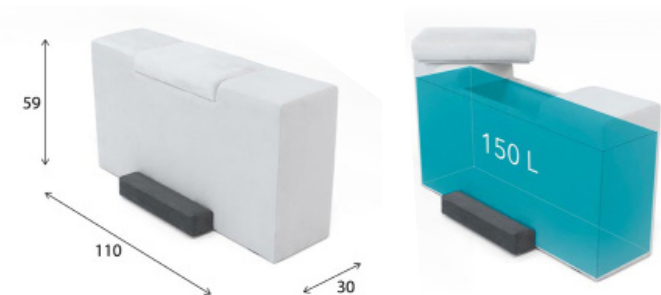

Specifiche Amelie

Divano angolare	283 x 173 cm
Divano dritto	346 x 110 cm
Letto doppio	280 x 232 cm
Altezza della seduta	39 cm
Altezza schienale	Modulo 59 cm, con cuscino 94 cm
Tessili	Certificato ÖKOTEX Standard 100
Spazio di stoccaggio	Ampio spazio di archiviazione sotto i braccioli
Materiale gambe divano	Faggio, legno massello

Cura del tessuto

È possibile rimuovere lo sporco superficiale, come le briciole, con un aspirapolvere. Fare attenzione a non spingere l'aspirapolvere all'interno del tessuto, ma a passarci sopra a una piccola distanza. Trattare i residui più ostinati con una spazzola morbida nella direzione del tratto.

Divano angolare

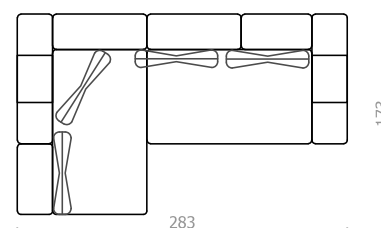

Divano angolare con pouf

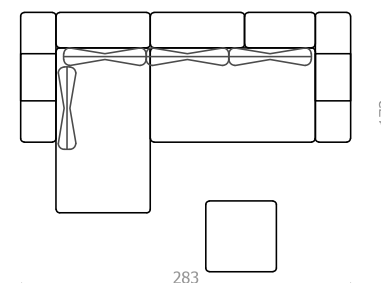

Divano dritto

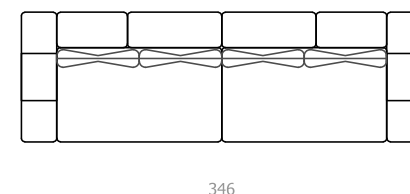

Letto doppio

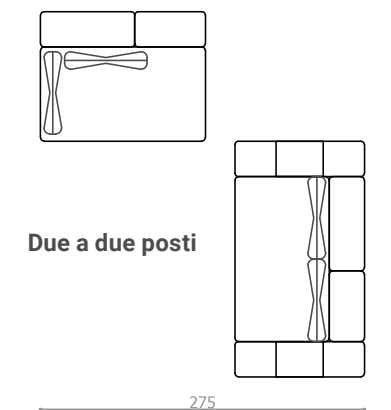
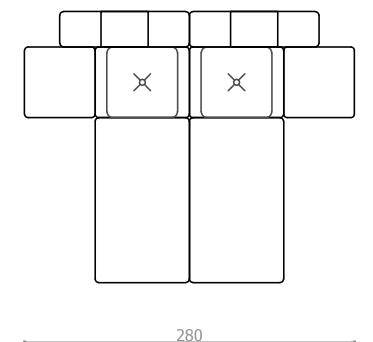

Due a due posti

Elementi per divani Amelie

Elemento A Variazioni

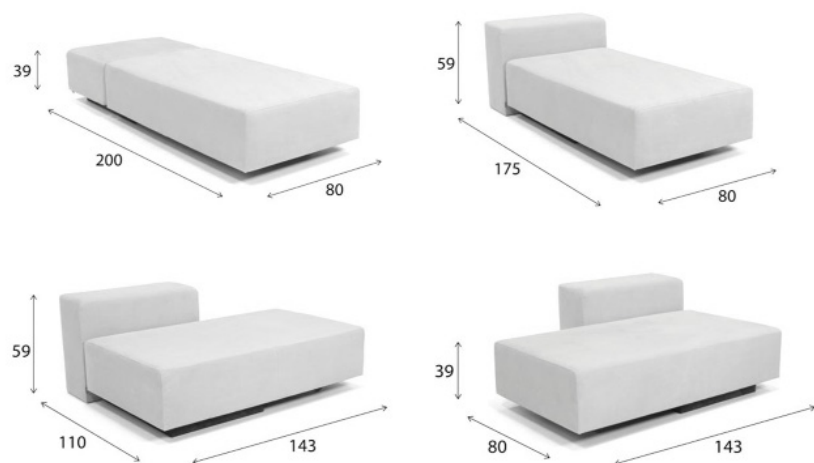

Elemento C Variazioni

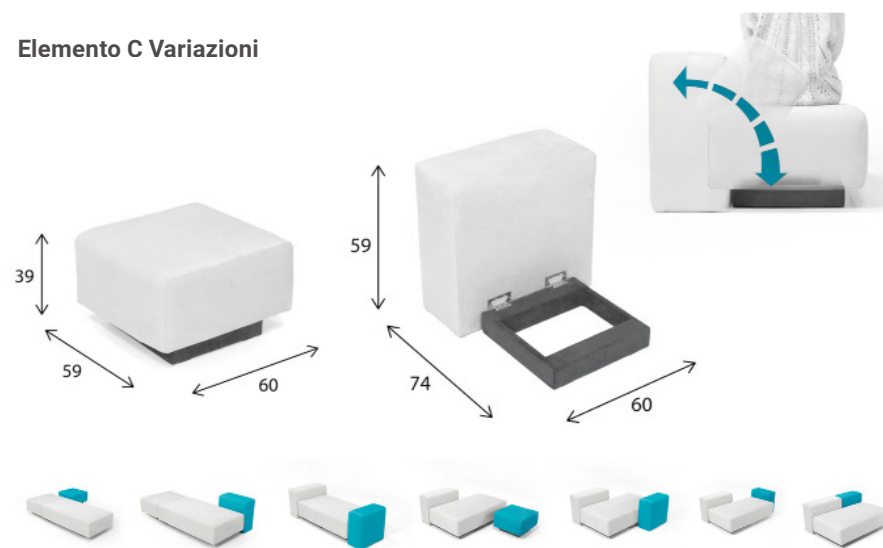

Elemento B



Elemento D
Spazio di archiviazione

