

# ZINC<sup>®</sup> E4 ELECTRIC SCOOTER

## OWNER'S MANUAL

### WARRANTY

SO THAT YOUR WARRANTY IS  
VALID PLEASE REGISTER AT  
**WWW.ZINCSPORTS.COM**  
WITHIN 30 DAYS OF  
RECEIVING THE PRODUCT.



**NOTE: MANUAL ILLUSTRATIONS ARE FOR REFERENCE ONLY.  
ILLUSTRATIONS MAY NOT REFLECT THE EXACT APPEARANCE OF THE ACTUAL PRODUCT.  
SPECIFICATIONS ARE SUBJECT TO CHANGE WITHOUT NOTICE.**

**READ AND UNDERSTAND THIS ENTIRE MANUAL BEFORE RIDING!**

### CUSTOMER HELPLINE

Hy-Pro Advise you to contact us directly and not to return this item to the place of purchase. Hy-Pro has taken great care to ensure this item has reached you in good condition, should you have a query please ring our helpline +44(0) 800 731 0006 where your call will be dealt with promptly. Alternatively, please contact us by email: [customerservices@zinchq.com](mailto:customerservices@zinchq.com)

### NEED HELP?

Visit our website for replacement parts and product support [WWW.ZINCSPORTS.COM](http://WWW.ZINCSPORTS.COM) Contact us at [CUSTOMERSERVICES@ZINCHQ.COM](mailto:CUSTOMERSERVICES@ZINCHQ.COM) or call our customer service line on **+44(0) 800 731 0006**

# CONTENTS

PRODUCT OVERVIEW .....	2
SAFETY WARNINGS - READ BEFORE USE .....	3-4
ASSEMBLY / HEIGHT ADJUSTMENT .....	5
HOW TO RIDE / OPERATING RANGE / BATTERY WARNING .....	6
CHARGING THE BATTERY / BATTERY DISPOSAL .....	7
HARDWARE MAINTENANCE .....	8
REPAIR AND MAINTENANCE / SPEC .....	9
TROUBLE SHOOTING GUIDE / SPARE PARTS .....	10
WARRANTY .....	11

## PRODUCT OVERVIEW

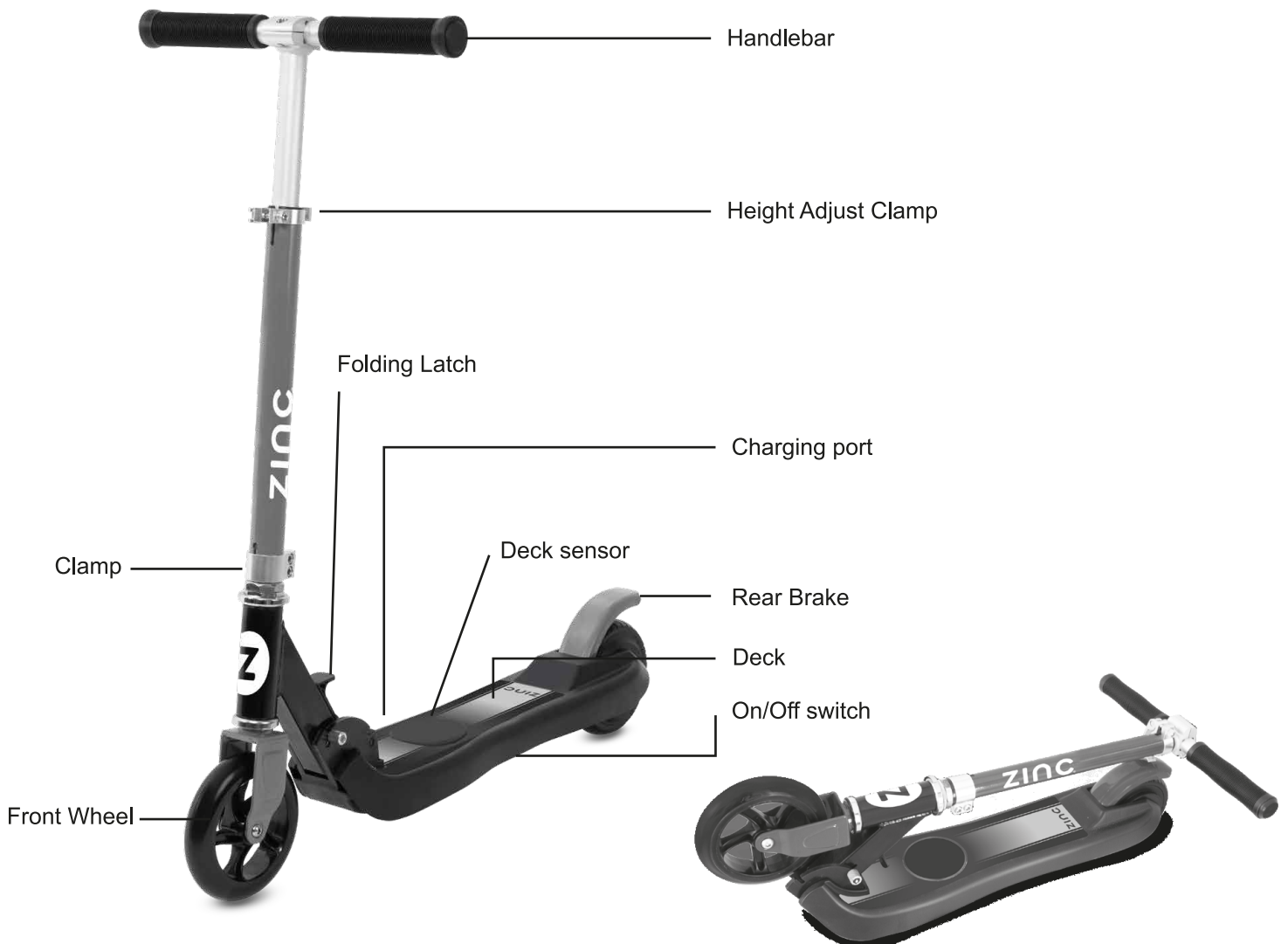

# SAFETY WARNINGS - READ BEFORE USE

 **WARNING!** - NOT FOR RIDERS UNDER AGE 6. DO NOT EXCEED THE WEIGHT LIMIT OF 55kg. This includes backpacks and other items that might be carried. Exceeding the weight limit could injure the rider and damage the E4 Scooter. Rider weight does not necessarily mean a person's size is appropriate to maintain control of the scooter. Keep this product away from small children and remember that it is intended for use only by one person who, at a minimum, is completely comfortable and competent while operating the E4 Scooter.

 **WARNING!** - Follow all local laws for pedestrians and vehicles. Check local laws and regulations to see where and how you may use your E4 Scooter legally.

 **WARNING!** - Only use the E4 Scooter outdoors. Avoid obstacles and slippery surfaces as these could cause a loss of balance for yourself or the scooter and could cause harm.

## USING THE CHARGER:

The charger supplied with the electric scooter should be regularly examined for damage to the cord, plug, enclosure and other parts, and in the event of such damage the scooter must not be charged until the charger has been repaired or replaced.

- Use only the recommended charger.
- Use caution when charging.
- The charger is not a toy.
- Charger should be operated by an adult.
- Do not operate charger near flammable materials.
- Unplug charger and disconnect from scooter when not in use.
- Do not exceed charging time.

Always disconnect from the charger prior to wiping down and cleaning your scooter with a damp cloth.

**FAILURE TO USE COMMON SENSE AND HEED THE ABOVE WARNINGS INCREASES RISK OF SERIOUS INJURY. USE WITH APPROPRIATE CAUTION AND SERIOUS ATTENTION FOR SAFE OPERATION.**

Do not ride indoors or on surfaces that could become damaged such as carpet or glossy flooring.

Be sure to regularly inspect and service the scooter and make sure all components and warning labels are in good condition.

Check all the fasteners and bolts are securely tightened before each use.

Riding the scooter is not advisable for persons with heart disease, pregnant women, people with illness, disabilities or who have recently had an operation. There is always a risk of injury and riders should carefully assess their own health and physical condition. If they are in any doubt as to their fitness to ride the scooter, they should consult with their GP beforehand.

After unpacking this product and before you first ride it, remember to charge it for at least 3 hours. Do not overcharge it, otherwise the service life of the battery and the charger may be compromised.



### PLEASE NOTICE

Speed and weight limits are set for your own safety.  
Please do not exceed the limits listed in the User Manual.

## Weight Restrictions

Maximum Weight: 55 kg.

## Speed Limits

Maximum Speed: 5mph/8kph

 **WARNING!** - CONTROLLER WILL AUTO CUT THE CIRCUIT IF OVERLOADED / CLIMBING A STEEP SLOPE, TO PROTECT THE MOTOR. RIDER CAN PUSH FORWARD WITH ONE FOOT AND THE DECK SENSOR WILL RE-ACTIVATE THE MOTOR.

# SAFETY WARNINGS - READ BEFORE USE

For your safety, please read the safety warnings carefully, and make sure you understand and accept all the safety instructions. The user will be responsible for any loss or damage caused by improper use.



## WARNING! -

1. Please wear all appropriate safety and protective gear such as helmet, knee and elbow pads and protective gloves, before operating the scooter.
  2. Make sure to wear comfortable clothes and flat, closed toe shoes when operating your scooter. Keep laces tied.
  3. Please carefully read the User Manual, which will assist in explaining the basic working principles and provide tips on how to best enjoy your scooter experience.
  4. Do not try to open or modify your scooter, as doing so will invalidate your manufacturer warranty, and may cause failure to your device leading to serious bodily injury or death.
  5. Do not ride your scooter near motor vehicles or on public roads. It's customer responsibility to ensure that their electric scooter is used in accordance with all local and country laws.
  6. Do not operate the scooter while under the influence of drugs and/or alcohol.
  7. Do not operate the scooter when you are restless or sleepy.
  8. Use your best judgment to keep yourself out of dangerous situations with your scooter.
  9. Do not ride your scooter off of curbs, ramps, or attempt to operate in a skate park, empty pool, or in any ways similar to a skateboard or stunt scooter. **THE SCOOTER IS NOT A STUNT SCOOTER.**
  10. Do not turn sharply, especially at high speeds.
  11. Do not abuse your scooter, doing so can damage your unit and cause failure to the operating system leading to injury.
  12. Do not drive in or near puddles of water, mud, sand, stones, gravel, debris or near rough and rugged terrain.
  13. The scooter can be used on paved roads that are flat and even. If you encounter uneven pavement, please lift your scooter over and past the obstruction.
  14. Do not ride in inclement weather: snow, rain, hail, sleet, on icy roads or in extreme heat.
  15. Do not ride in or near puddles, pools or other large bodies of water.
  16. Bend your knees when riding on bumpy or uneven pavement to absorb the shock and vibration and help you keep your balance. If you are unsure if you can safely ride on a specific terrain, step off and carry your scooter.
- ALWAYS RIDE WITH CAUTION.**
17. Do not attempt to ride over bumps or objects greater than 1.5cm even when prepared and bending your knees.
  18. PAY ATTENTION - look at where you are riding and be aware of the road conditions, people, places, property and objects around you.
  19. Do not operate the scooter in crowded areas.
  20. Operate your scooter with extreme consideration for people and property at all times.
  21. Do not operate the scooter while talking, texting, or looking at your phone.
  22. Do not ride your scooter where it is not permitted.
  23. Do not use the scooter to place yourself or anyone else and their property in danger.
  24. Do not climb or travel down steep hills with your scooter.
  25. The scooter is intended for use by one person, DO NOT attempt to operate the scooter with two or more people.
  26. Do not carry anything in your arms while riding the scooter.
  27. Women who are pregnant should not operate the scooter.
  28. Riders should not operate the scooter without proper instruction and supervision from an experienced user.
  29. At higher speeds, always take into consideration longer stopping distances.
  30. Do not ride the scooter in wet or icy weather and never immerse the scooter in water, as the electrical and drive components could be damaged by water or create other possibly unsafe conditions.
  31. Do not attempt to jump on or off your scooter.
  32. Do not ride the scooter in dark or poorly lit areas.
  33. Do not operate your scooter off-road.
  34. Do not exceed the maximum weight limits.
  35. Avoid driving the scooter in unsafe places, including near areas with flammable gas, steam, liquid, dust, fiber, which could cause fire and explosive accidents.
  36. Applying brakes too hard or too suddenly can lock up a wheel, which could cause you to lose control and fall. Sudden or excessive application of the brake may result in injury or death.
  37. When you ride the scooter along with other riders, always keep a safe distance to avoid a collision.
  38. Check the limitation of use according to regulations of road safety.

# BEFORE YOU START

Before you first experience your scooter, please read the **USER MANUAL** thoroughly and learn the basics to ensure your safety and the safety of others.

**WARNING** Failure to follow the basic instructions and safety precautions listed in the **USER MANUAL**, can lead to damage to your scooter, other property damage, serious bodily injury, and even death.

**Adult assembly required.**

**Allow at least 3 hours for initial charge. By not doing so you will invalidate the warranty.**

**WARNING!** Before assembling the scooter, please check whether the power switch is in the "OFF" position, if not, please put it in the "OFF" position before continuing with assembly.

## ASSEMBLY:

- Assembly can typically be completed in up to 5 minutes, not including the initial charge time.
- Charging time is at least 3 hours for the first time.

### 1. To unfold the E4 Scooter

- Pull open the lever on the side.
- Pull up the release lever.
- Swing open the scooter fully until the locking mechanism locks into the slot.
- Push close the side lever. Hand tighten the screw bolt on the opposite side to hold firm.

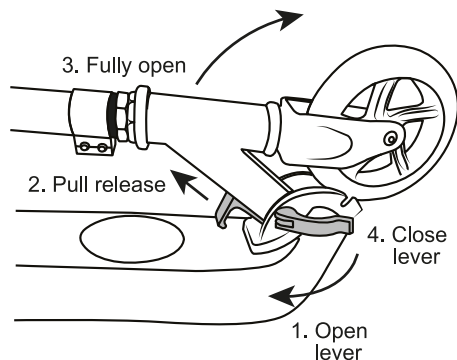

### 2. Handlebar Assembly

- Remove the top plate with the allen key provided.
- Centrally align the handlebar grips across the stem.
- Replace the top part of the clamp, ensuring it locks together at point 'A'.
- Firmly tighten the top nut with the allen key.

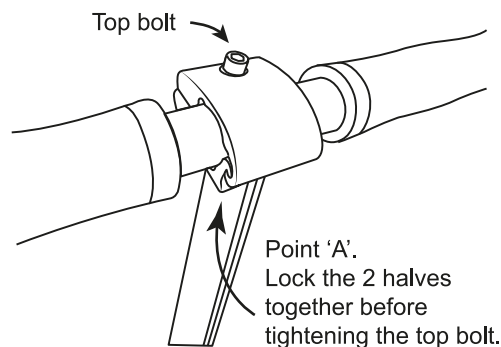

### 3. To fold the E4 Scooter

- Pull open the lever on the side.
- Ensure the front wheel is at 180° angle to the scooter.
- Pull up the release lever.
- Fold down the scooter fully until the locking mechanism locks into the slot.
- Push close the side lever. Hand tighten the screw bolt on the opposite side to hold firm.

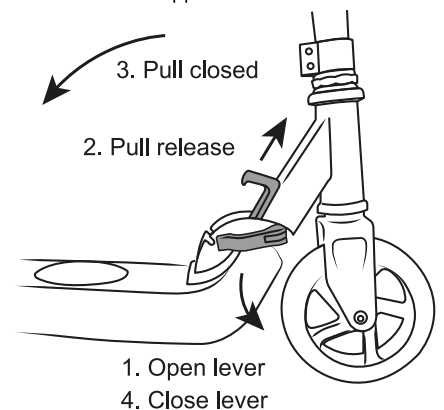

## HEIGHT ADJUSTMENT:

How to adjust the height of the stem.

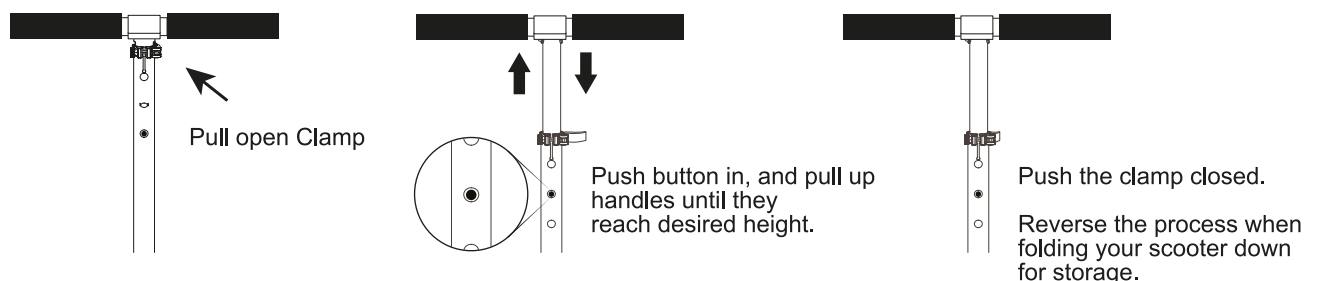

**WARNING!** - ONLY USE GENUINE ZINC REPLACEMENT PARTS. The scooter has been built to certain Zinc design specifications. The original equipment supplied at the time of sale was selected on the basis of its compatibility with the frame, fork and all other parts. Certain aftermarket products may or may not be compatible and will invalidate the warranty if used.

# HOW TO RIDE

**WARNING!** There is risk of falling down whilst riding, so make sure to wear helmet and protection kits all the time.

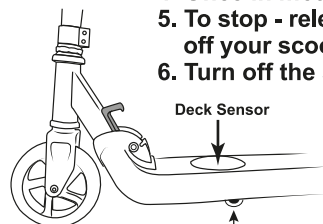

1. Turn on the scooter via the switch under the footplate.
2. Put one foot on the Deck Sensor and kick off with the other foot. The E4 is kick motion activated. You will need to push forward with the other foot before the motor activates.
3. You will need to press the deck sensor continuously for the motor to engage.
4. Once in motion, the motor propels the E4 up to 5mph/8kph.
5. To stop - release the deck sensor and press the rear foot brake until stopped then step off your scooter.
6. Turn off the scooter via the switch under the footplate.

## OPERATING RANGE

Please notice the scooter can travel a distance of 3.1 miles/5km on a fully charged battery in ideal conditions. The following are some of the major factors that will affect the operating range of your scooter.

**Terrain:** A smooth, flat surface will increase your driving distance, while driving uphill, as well as rough or uneven terrain will reduce your distance significantly.

**Weight:** The weight of the user can affect driving distance, a lighter user will have further range than a heavier user.

**Ambient temperature:** Please ride and store the scooter under recommended temperatures, which will increase driving distance, battery life, and overall performance of your scooter.

**Maintenance:** Reasonable battery charging and maintenance will increase the distance. Overcharging the battery can reduce range.

**Speed and Driving Style:** Maintaining a moderate speed will increase your distance: while travelling at high speeds for extended periods, frequent starts, stops, idling, along with frequent acceleration and deceleration will reduce your overall distance.

## BATTERY WARNING

### Battery Specifications

Battery	Lithium Battery
Charging time	3 hours
Voltage	21.6 V
Initial Capacity	2000 mAh
Working Temperature	-10°C ~ 60°C
Charging Temperature	0°C ~ 45°C
Storage Time	6 months
Storage Temperature	-20°C ~ 50°C
Storage Humidity	Relative Humidity 45%-85%

### BATTERY WARNING

Failure to follow the Safety Precautions listed as below could lead to serious bodily injury and death. Seek immediate medical attention if you are exposed to any substance that is emitted from the battery.

- Do not attempt to modify, change, or replace your battery.
- Do not use your scooter if the battery begins to emit odor, overheats, or begins to leak.
- Do not touch any leaking materials, or breathe fumes emitted.
- Do not allow children and animals to touch the battery.
- The battery contains dangerous substances, do not open the battery, or insert anything into the battery.
- Please only use the charger provided by manufacturer.
- Do not attempt to charge the scooter if the battery has discharged or emitted any substances. In that case, the battery should be abandoned for safety.
- Please follow all local, state and federal laws in regards to recycling, handling and disposing of Lithium batteries.
- The scooter should only be shipped in its original packaging.
- Do not throw away your packaging box as you may need it for future use or should you need to return it.
- Do not place the battery in an environment where the ambient temperature is higher than 50°C or lower than -20°C (e.g., do not leave the scooter or the battery pack in a car under direct sunlight for an extended time). Do not throw the battery pack into fire as it may lead to battery failure, battery overheating, and even another fire. If the scooter is expected to be left idle for more than 30 days, please fully charge the battery and place it in a dry and cool place.

# CHARGING THE BATTERY

This section is intended to provide you basic information about your battery and charger. Please read this section carefully to ensure your safety. For user safety and to prolong the life of your battery, as well as improve battery performance, please follow these instructions.

When the battery has run down, please charge your battery for 3 hours with the charger that you received with your scooter.

**Step 1:** Ensure your scooter is turned off before you attempt to charge the battery.

**Step 2:** Ensure that the charging port is clean and dry.

**Step 3:** Plug the charger into the power socket, make sure the light on the charger is lit GREEN.

**Step 4:** Put the male DC connector plug into the charging port of the scooter. The indicator light on the charger should change to RED, indicating that your scooter is now being charged. When the RED indicator light on your charger turns to GREEN then your scooter is fully charged.

A full charge typically occurs at 3 hours.

**Step 5:** Please unplug the charger from your scooter and from the power outlet.

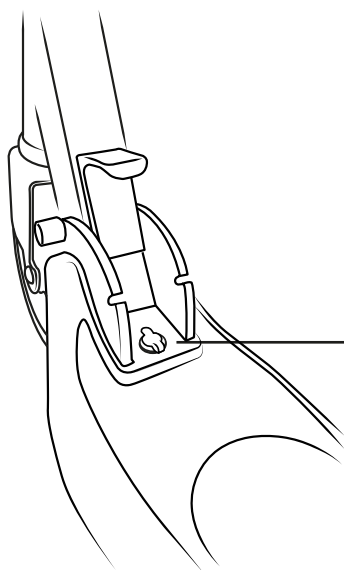

**Charging port located at front of scooter.**

Remove the plug before charging, and replace to keep out dust and water.



## IMPORTANT NOTES ABOUT CHARGING

If the green light on your charger does not turn RED when you plug it into your scooter, it could mean you have to check the cables to ensure you have a proper connection; or that your scooter is already fully charged.

- Do not overcharge, as this will affect the life of the battery.
- The best charging temperatures are between 0°C~45°C. Extreme cold and extreme heat will prevent your battery from charging fully.
- Make sure to unplug your charger before standing on or operating your scooter, as this can be very dangerous.
- Use only the scooter charger that you received in your packaging.



## NOTE

Only the indicator light on the charger will tell you the status of the battery during charging.

## BATTERY DISPOSAL

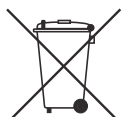

**Do not store the battery in temperatures above 50°C or below -20°C.**

**CONTAINS SEALED LITHIUM-ION BATTERIES. BATTERIES MUST BE RECYCLED.** Your

Zinc product uses sealed lithium-ion batteries which must be recycled or disposed of in an environmentally sound manner. Do not dispose of a lithium-ion battery in a fire. The battery may explode or leak. Do not dispose of a lithium-ion battery in your regular household trash. The incineration, land filling or mixing of sealed lithium-ion batteries with household trash is prohibited by law in most areas. Return exhausted batteries to a local, approved battery recycler or a local seller of automobiles.

# HARDWARE MAINTENANCE

## INSPECTION, MAINTENANCE, AND STORAGE

Your scooter requires routine inspection and maintenance. This chapter describes maintenance steps and important operating tips. Before you perform the following operations, ensure the power and charging cables are disconnected.

### INSPECTING AND CLEANING YOUR SCOOTER

- Disconnect the charger and turn off your scooter.
- Routinely check the body of the scooter and tyres for damage or excessive wear.
- Wet a clean cloth with clean water, rinse the cloth thoroughly, and wipe the body of the scooter making sure that water does not get into the power button, charging port or tyres.

### STORING YOUR SCOOTER

When the scooter is not in use ensure it is not layed down or knocked over. If dropped, essential components can be damaged and could affect the use and running of the scooter, as well as void the warranty. If you damage this part of the scooter it is strongly advised that you replace the damaged parts as soon as possible to avoid any accident caused by making contact with them.

- Fully charge your battery before storing.
- If you are storing your scooter for an extended period of time, please fully charge your scooter at least once every month.
- If the ambient temperature of the storage location is below 0°C, please do not charge. You must bring the scooter into a warmer environment before charging.
- Check under Battery Specifications for more details.
- To prevent dust from getting into your scooter, try wrapping it or sealing it with its original packaging.
- Store your scooter indoors, in a dry and suitable temperature.

### BRAKE

Check the brakes function properly.

- A) When you apply the brake pedal, the rear wheel should stop rotating;
- B) Make sure the wheels are able to rotate freely, without getting stuck/ any stopping when the brake is not applied.

### FRAME, FORK AND STEERING HANDLE

Check the frame, fork and steering handle for cracks or loose connections. It is necessary and important to check the scooter regularly.

### TYRES

Periodically inspect the wheels and tyres for excessive wear.

### BATTERY

Always switch off the power when the scooter is not in use. Never store the scooter at a low temperature, it may damage or degrade the battery permanently.



**WARNING! - FAILURE TO FOLLOW THESE INSTRUCTIONS MAY DAMAGE YOUR PRODUCT AND VOID WARRANTY.**

**WARNING: BE SURE THAT YOU ARE IN A SAFE PLACE AND OPEN AREA BEFORE STARTING YOUR SCOOTER. NEVER START THE SCOOTER UNTIL YOU HAVE TAKEN GOOD HOLD OF THE HANDLEBARS AND BALANCE YOURSELF ON THE SCOOTER.**



# REPAIR & MAINTENANCE

Lithium battery may get hot, explode or ignite and cause serious injury if exposed to abusive conditions. Be sure to follow the safety warning listed below:

- Store battery (scooter) at room temperature between 15 - 25°C for best results.
- Do not expose battery pack (scooter) to direct sunlight (heat) for extended periods.
- When transporting or temporarily storing in a vehicle, temperature range should be greater than -20°C but no more than 50°C.
- Storing battery at temperatures greater than 75°C for extended periods of time (more than 2 hours) may cause damage to the battery and possible fire.
- Do not connect the positive terminal and negative terminal of the battery to each other with any metal object (such as wire).
- Do not carry or store battery together with necklaces, hairpins or other metal objects. Do not pierce the battery with nails, strike the battery with a hammer, step on the battery or otherwise subject it to strong impacts or shocks. Do not expose battery to water, or allow the battery to get wet. Remember to turn off the battery (scooter) when not in use.
- Do not disassemble or modify the battery. The battery contains safety and protection devices, which, if damaged, may cause the battery to generate heat, explode or ignite.
- Do not charge unattended. Immediately discontinue use of the battery if, while using, charging or storing the battery, the battery emits an unusual smell, feels hot, changes colour or shape or appears abnormal in any other way.
- This product must only be used with the recommended transformer. Product liable to be cleaned with liquids are to be disconnected from the transformer before cleaning. A healthy battery should only get slightly warm during charging. If the battery becomes hot, smokes, swells, or gives off an odor during charging, terminate charging immediately and contact the manufacturer.
- Note - the charger itself may get quite warm to the touch when charging a deeply discharged battery.

## CHARGER

The charger supplied with the scooter should be regularly examined for damage to the cord, plug, enclosure and other parts. In the event of such damage the scooter must not be charged until the charger has been repaired or replaced.

## REPLACEMENT PARTS

For a complete selection of replacement parts visit [www.zincsports.com](http://www.zincsports.com)

## WHEELS

Wear and tear is unavoidable in the wheels and the driving system in the course of operation. The user must regularly check the wheels and the driving system for wearing and make adjustment or replacement when necessary.

# SCOOTER SPECIFICATIONS

- Net Weight: 4.82 kg
- Load: 55kg
- Max Speed Limit: 5mph/8kph
- Max Distance: 3.1 miles/5km \*The range is tested in the lab (real range depends on user weight, incline, road condition and other factors.)
- Battery: Lithium, 2000mAh, 21.6 V
- Input: AC100v-240v ~ 50/60Hz 0.8A Max
- Size (fold): L 67 X W 37 X H 24.5 cm
- Size (unfold): L 73 x W 37 x H (78-86) cm
- Tyre: solid tyre

# TROUBLESHOOTING

PROBLEM	POSSIBLE CAUSE	SOLUTION
Scooter will not run.	Battery is not charged.	Charge the battery for at least 3 hours for the first charge, and at least 3 hours for subsequent charges.
	Charger is not working.	Make sure power flow to the wall outlet is on.
Scooter run time is short.	Battery requires charging.	Charge the battery for at least 3 hours for the first charge, and at least 3 hours for subsequent charges.  Make sure charger plug is connected to 100-240V power supply.
	Battery will not fully charge.	Make sure power flow to the wall outlet is on.  Battery may need to be replaced. Even with proper care, rechargeable batteries do not last forever. The average rechargeable battery life is 1 to 2 years depending on scooter conditions and use. Replace only with Hy-Pro replacement batteries.
Scooter runs sluggishly.	Scooter is overloaded.	Make sure the scooter is not overloaded. This product is designed to sustain a maximum of 55kg. An excessive overload triggers off automatic protection and makes the scooter refuse to start. Do not ride uphill a steep slope or use the scooter to tow any cargo. Do not overload the scooter, which may cause the battery and the electronics to age prematurely and damage the power system.
	Unsuitable riding conditions.	Only ride on solid, even clean and dry surfaces such as pavement and flat ground.
Sometimes the scooter doesn't run.	Loose wires or connection.	Check all wire around the motors and all connectors to make sure they are tight.
	Motor or electrical switch damage.	Contact ZINC Customer Services +44 (0) 800 731 0006 for diagnosis and repair options.
The scooter motor cuts out and will not start after the scooter has been ridden up steep gradients or in situations where the maximum load has been exceeded on the scooter.	Battery Management System (BMS)	The battery incorporates a management system that will automatically cut out the power. If these situations occur the rider can push forward with one foot and the deck sensor will re-activate the motor. Please do not run the scooter under these conditions as the BMS will continue to cut the power as the battery and motor are being overloaded.

## SPARE PARTS:

Due to general wear and tear, occasionally you may need to purchase spare parts to keep your scooter in peak condition. It is important to use the correct spare parts for your particular model ie. ZINC E4 ELECTRIC SCOOTER, and that you purchase them directly from us.

Visit our website [WWW.ZINCSPORTS.COM](http://WWW.ZINCSPORTS.COM) and go to 'Spare Parts'.

If you have any problem selecting the parts you require, contact Zinc Customer Services on +44 (0) 800 731 0006.

# WARRANTY

## ZINC SPORTS ELECTRIC SCOOTER WARRANTY POLICY

Thank you for purchasing a Zinc electric scooter and we hope you enjoy using it. Please ensure that you read the following warranty. In order for your warranty to be valid you must satisfy the following conditions.

- All products must be registered at [www.zincsports.com](http://www.zincsports.com) within 30 days of receiving the product for the warranty to be valid.
- Proof of purchase is also required for your warranty to be valid.
- You must be the original purchaser who bought the product from an authorised dealer, your warranty cannot be transferred.
- You must report any defects to Zinc Sports within 30 days of discovery of said defect else the warranty will not be valid.

Failure to follow the conditions highlighted above means that your warranty will be void. We recommend that you save your original sales receipt. Assuming that you have followed the conditions highlighted above, your product will have a 12-month limited warranty from defects in the materials used to manufacture, and/or workmanship at the time of manufacture outside areas covered below.

Our warranty includes:

COMPONENT:	TIME FRAME:
Battery	3 months
Controller	3 months
Charger	6 months
Motor	6 months
Frame	12 months
Vehicle body outside areas stipulated in the warranty	6 months

All scooters have an IP rating of IPX4. The warranty will be void if the scooter has any water ingress or damage as a result of water ingress. The warranty may be void if the scooter has been used in the rain, through deep puddles, jet washing and submersion. No warranty is provided for corrosion damages as a result of contact with water/humidity conditions. All electric scooters include Liquid Contact Indicators on the battery pack. The Liquid Contact Indicators show if the device has come into contact with water or a liquid containing water, the Liquid Contact Indicators turn red when they come into contact with water or a liquid containing water. The warranty is void if the Liquid Contact Indicators are red.

Under no circumstance will Zinc Sports be obliged to provide compensation for bodily injuries, death, property damages, losses, hindrance of profits, prevention of use or any other damage that will be caused directly or indirectly as a result of usage of this device. Zinc Sports advice that you contact your insurance company to determine whether coverage is provided for the use of this scooter, or to take out a new policy.

For the full warranty policy please visit our website at [www.zincsports.com](http://www.zincsports.com)

**PRODUCT CODE: ZC06517 E4 BLUE**

### ©ZINC

Manufactured by  
Hy-Pro International  
Hy-Pro House, Centrus Park, Arenson Way,  
Dunstable, Bedfordshire, LU5 5BN, UK  
Made in China

HY-PRO EUROPE  
CUBE BUILDING, MONAHAN ROAD,  
CORK, T12H1XY

Hy-Pro Asia  
Room 1011, 10/F, Peninsula Centre,  
67 Mody Road, Kowloon, Hong Kong