

OPERATOR'S MANUAL



The Belmont[®] Rapid Infuser, RI-2



780 Boston Road
Billerica, MA 01821, USA

866-663-0212 US/Canada
978-663-0212 Worldwide



The Belmont[®] RAPID INFUSER, RI-2



OPERATOR'S MANUAL



Belmont Instrument Corporation
780 Boston Road
Billerica, MA 01821, USA



EMERGO EUROPE
Molenstraat 15
2513 BH, The Hague
The Netherlands
Tel: +31 (0) 70 345 8570
Fax: +31 (0) 70 346 7299

All service calls & questions should be directed to

855-397-4547 US/Canada
978-663-0212 Worldwide

CAUTION: Federal law (USA) restricts this device to sale by or on the order of a physician.

P/N 702-00190 Rev C

The Belmont® Rapid Infuser RI-2
Operator's Manual
Table of Contents

Page No.

CHAPTER 1: INTRODUCTION - SYSTEM OVERVIEW

Introduction	1
Indications for Use	1
Contraindications	1
Overview of the Belmont® RI-2	2
Control Panel: Display and Keys	3

CHAPTER 2: OPERATION

Introduction	4
Step-by-Step Operating Procedures.....	5
IV Pole Mounting.....	5
Installing the Disposable Set.....	6
Installing the Optional Large Reservoir.....	7
Powering On the System	8
Installing Fluid Bag.....	8
Priming the Main System	9
Priming the Patient Line	9
Connecting to Patient.....	10
Match the Infusion Set to Flow Rate and Fluid Type	10
Initiating Infusion	10
Maintain Infusion.....	11
Pressure Control.....	11
Automatic Air Purging.....	11
Bolus Infusion (Infuse a Fixed Volume).....	12
Recirculation.....	12
Stop	12
Battery Operation	13
Low Battery.....	13
Accidental Power Off.....	13
End of Procedure	14
Emergency Manual Operation	14

CHAPTER 3: ALARMS AND TROUBLESHOOTING GUIDE

Introduction	15
A. Operational Alarms	15
Air Detection	15
Door Open	16
Fluid Out	16
High Pressure	17
Low Battery	17
Missing Disposable	17
B. Heating Alarms	18
System Error #101 (Heating Fault)	18
System Error #102 (Over Temperature)	18
C. Hardware Alarms	19
System Error #201 (Air Detector Fault)	19
System Error #202 (Fluid Out Detector Fault)	19
System Error #203 (Heater Fault)	19
System Error #204 (Heater Feedback Fault)	19
System Error #205 (Heater Hardware Fault)	19
System Error #206 (Power Module Overheat)	19
System Error #207 (Pump Fault)	19
System Error #208 (Valve Fault)	20
System Error #209 (Board Overheat)	20
System Error #210 (Internal Computer Malfunction)	20
Troubleshooting Other Operational Difficulties	21

CHAPTER 4: PARAMETERS SETTING AND PREVENTIVE MAINTENANCE

Introduction	23
A. System Setup	24
1. Date/Time	25
2. Display Brightness	26
3. Language Setup	26
4. Key Rate	26
5. Bolus Volume	26
6. Pressure Limit	26
B. Service and Preventive Maintenance Schedule	27
Schedule 1	27
Schedule 2	27
C. Routine Maintenance	28
1. Clean and/or Disinfect Exterior	28
2. Fluid Out and In-Line Air Detectors	28
3. Power Cord	28
4. Temperature Probes	28
5. Fan Guards	28
6. Seals	28
7. Instrument Door and Ceramic Disks	29
8. Rubber Feet	29

D.	Testing the System and Operational Check-Out	30
1.	Visual Inspection	30
2.	System Operational Checkout	31
3.	Battery Run Time	31
4.	Electrical Safety Test - Leakage Current	32
5.	Hardware Verification.....	34
6.	Clean the pump head.....	39
E.	Checklist.....	40
F.	Electromagnetic Compatibility.....	42
G.	Fuse	44
H.	Calling for Service	44

CHAPTER 5: TECHNICAL SPECIFICATIONS

Dimensions	45
Power AC	45
Battery	45
Environment	46
Operating Parameters.....	46
Operating Panel	47
Safety and Monitoring	47
Alarm States and Controls	48
Disposable Sets	48
Classifications	49
Symbols and Definition	50

It is essential that you read and understand this manual before operating the system.

The **Belmont[®] Rapid Infuser**, RI-2, warms blood, colloid, and crystalloid to physiologic temperature at user-set rates from 10 to 750 milliliters per minute (ml/min) with 1000 ml/min as an option. 2.5 and 5.0 ml/min (150 and 300ml/hr) are also available to keep the venous line open.

The system monitors temperature, line pressure, and air in the fluid path to ensure safe operation and alarms at all unsafe conditions. A hardware override circuit prevents unsafe operation in case of system computer failure. A screen displays flow rate, total fluid infused, temperature, line pressure, alarm and status messages and proper procedures to proceed safely after an alarm situation. Keys appropriate to a particular point in the operation are displayed on the touch screen.

A battery backup allows for mobile transport of the patient. During battery operation, fluid warming is disabled while pump operation and safety monitoring remain active. The built-in rechargeable battery automatically charges whenever the system is connected to line power.

INDICATIONS FOR USE

- Infusion of crystalloid, colloid, or blood product, including packed red blood cells, as volume replacement for patients suffering from blood loss due to trauma or surgery.
- Infusion of warmed fluid to re-warm patients after surgery or for hypothermia.
- Infusion of warmed fluid for irrigation in urology procedures.

CONTRAINDICATIONS

- The system should not be used where the desired flow rate is below 2.5 ml/min or above 1000 ml/min.
- The system should not be used to warm platelets, cryo-precipitates, or granulocyte suspensions.
- This system is not intended for drug administration.
- The Belmont[®] RI-2 should not be used where rapid infusion is medically contraindicated.
- Lactated Ringer's solution, dextrose in water, and hypotonic sodium chloride solutions should not be added to blood components (AABB Technical Manual 17th edition, page 624)

OVERVIEW OF THE BELMONT RI-2

The complete system consists of the RI-2 **Control System**, which is mounted on an IV pole, and the **Disposable Set**. The RI-2 can be used **only** with the supplied disposables. A large volume 3-liter reservoir is available as an optional accessory for convenience in cases involving very large infusion volumes, see page 7.

The **Disposable Set** is preconnected and has a sterile fluid path. It is intended for **single patient use only**.

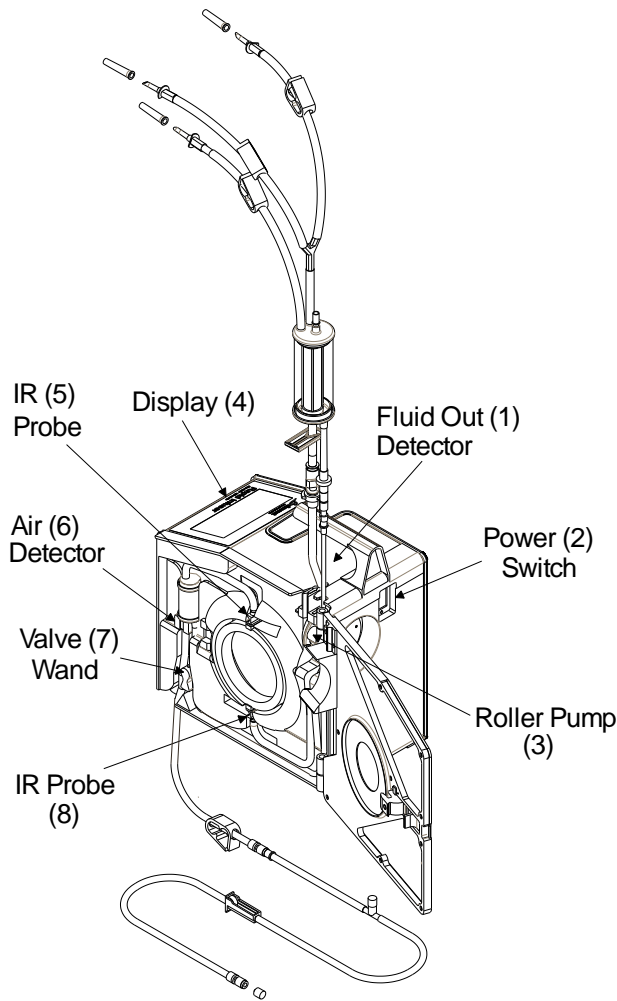

System Diagram Showing Main Components

Major components of the Control System:

1. Fluid Out Detector detects and alarms at an out of fluid situation.
2. Power Switch turns system power on and off.
3. Roller Pump is designed for pumping accuracy and reliability.
4. Display and control panel show status and alarm messages with touch keys at the bottom of the screen.
5. IR Temperature Probe (Output Probe) monitors output fluid temperature as it exits the Heat Exchanger.
6. Air Detector detects air in the line. If air is detected the valve wand is closed immediately to prevent air into the patient. Pumping and heating stop, alarm sounds and "Air Detection" message is displayed on screen.
7. Valve wand closes off the recirculation line when the system is in the infusion mode and closes off the infusion line when the system is in the recirculation mode. It immediately closes the infusion line to the patient when an error condition occurs which may require user intervention.
8. IR Temperature Probe (Input Probe) monitors input fluid temperature as it enters the Heat Exchanger.

CONTROL PANEL: DISPLAY AND KEYS

The control panel consists of the touch screen display, which incorporates a bright graphical display with touch pad keys. The display shows status and alarm messages at the top and middle, and contains the touch keys at the bottom.

CONTROL PANEL SUMMARY

Status Display:

- **Flow Rate in ml/min (The RI-2 displays both the user Set Flow Rate and the Actual Flow Rate)**
- **Volume Infused**
- **Infusate Temperature in °C**
- **Pressure in the Fluid Line in mm Hg**
- **Bolus Volume (when infusion of a fixed bolus of fluid is desired).**

Function Keys: The keys that control all system functions are displayed on the screen. The screen is changed each time a function key is pressed. Only keys that are relevant to the desired function are presented. The active key is highlighted.

There are three (3) different levels of sensitivity: Fast, Medium, and Slow. The key sensitivity is set at the factory to medium, but can be adjusted by the operator in SERVICE MODE.

See Chapter 4, page 26 for 'Key Rate' sensitivity setup.

Alarm Display: Graphical alarm messages indicating where errors have occurred and suggested operator action.

OPERATION

This chapter explains the procedure for setting up and initiating safe and effective operation of the **Belmont[®] Rapid Infuser, RI-2**. To change screens' language, select language at start-up or go to Chapter 4 "LANGUAGE SETUP" to setup your preferred language.

WARNING!

Do not use this product in the presence of flammable anesthetics.

WARNING!

To avoid risk of electric shock, this device must only be connected to a supply main with protective earth.

WARNING!

Do not use with pressure infusers or "bag squeezers". The system pump provides adequate pressure to infuse fluid.

WARNING!

The Belmont[®] Rapid Infuser, RI-2, is not for use in warming platelets, cryoprecipitates, or granulocyte suspensions.

WARNING!

The Belmont[®] Rapid Infuser, RI-2, is intended for infusion of high volume warm replacement fluid or blood component. It is not intended for drug administration.

WARNING!

Do not mix lactated Ringer's or other solutions containing calcium with citrated blood products.

Use only anticoagulated blood products.

STEP-BY-STEP SUMMARY OF OPERATING PROCEDURES

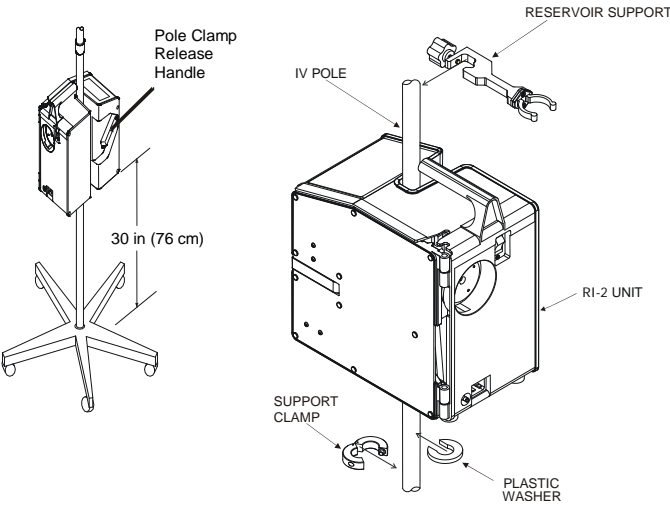
<p>SET-UP</p> <p>INSPECT THE SYSTEM</p> <ul style="list-style-type: none"> • Power cord • Reservoir Support • Disposable Set • Large Reservoir and holder, if needed <p>IV POLE MOUNTING</p> <ul style="list-style-type: none"> • IV Pole: 5 wheel, maximum diameter 1 1/4" • Install the Support Assembly 30" from the ground, if not already installed. • Mount the RI-2 on the IV Pole above the Support Assembly • Install the Reservoir Support app. 9" above the top of the system <p style="text-align: center;">CAUTION:</p> <p>Check that the system is securely clamped to an IV pole and will not tip over</p>	<p>Inspect the system to ensure that you have all necessary components.</p> <p>Use only supplied power cord.</p> <div style="text-align: center; margin: 20px 0;">  </div> <ol style="list-style-type: none"> 1. Install the support assembly (support clamp and washer) approximately 30" from the ground. <ul style="list-style-type: none"> • While holding clamp closed, loosen the screw to open up the clamp. Install clamp on the IV pole, holding clamp close and tighten screw using the supplied 3/16 Allen wrench. • Snap the plastic washer onto the IV pole above the support clamp. 2. Lift up on the "Pole Clamp Release Handle" to open. Mount the system onto the IV pole, above the support assembly, by pushing down on the pole clamp release handle. Check that the system is locked in place before proceeding. 3. Clamp the reservoir support onto the IV pole approximately 9" above the RI-2. <ul style="list-style-type: none"> • Make certain that there is nothing obstructing the air vents at the bottom of the system.
--	--

INSTALLING DISPOSABLE SET

WARNING:

The disposable set is for single patient use only. Do not reuse.

Store the disposable set in a dry well-ventilated area free from exposure to chemical vapors.

We strongly recommend loading and priming the disposable set just prior to the procedure.

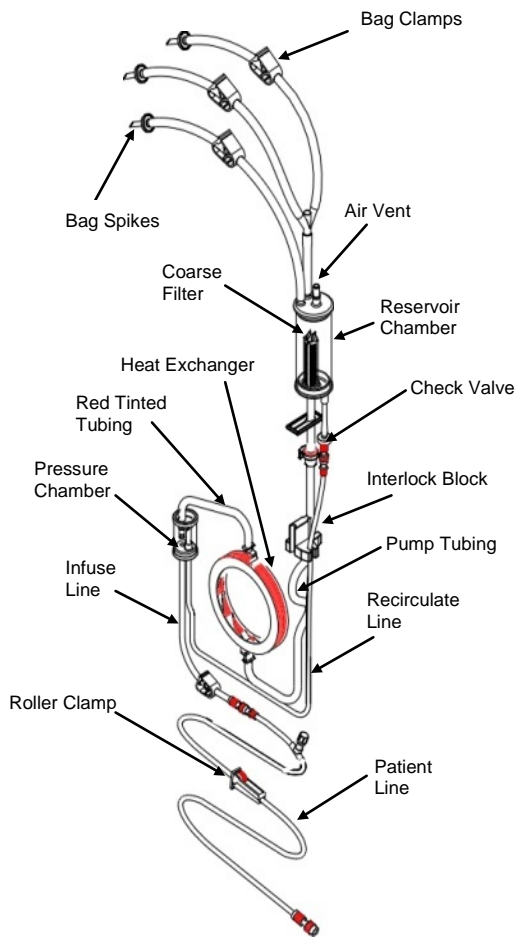

3-Spike Disposable set with key components



1. Snap reservoir chamber into the reservoir support clamp.
2. Open the door. Insert heat exchanger with red arrow pointing up (**Red tinted tubing** to red stripe on unit.)



3. Firmly position the interlock block into the fluid out detector.
4. Guide the curved piece of pump tubing (**Blue tinted tubing**) over the pump head. Check that the thinner recirculate line is in the groove to the right.

Do not kink or twist the tubing



5. Place the pressure chamber into the pressure chamber well. Firmly insert the wider infuse line into the air detector and to the left of valve wand.

Do not apply excessive pressure to the pressure transducer. The pressure transducer can be damaged with excessive force. Do not use the system if the pressure transducer is damaged.

6. Place the thinner recirculate line to the right of the air detector, and to the right of the valve wand.
7. Close and latch the door. Make certain the pump tubing is not caught. Connect the patient line.

INSTALL OPTIONAL LARGE RESERVOIR, IF NEEDED

- Install large reservoir holder
- Install large reservoir

**CAUTION:**

Do not pressurize or apply a vacuum to the reservoir

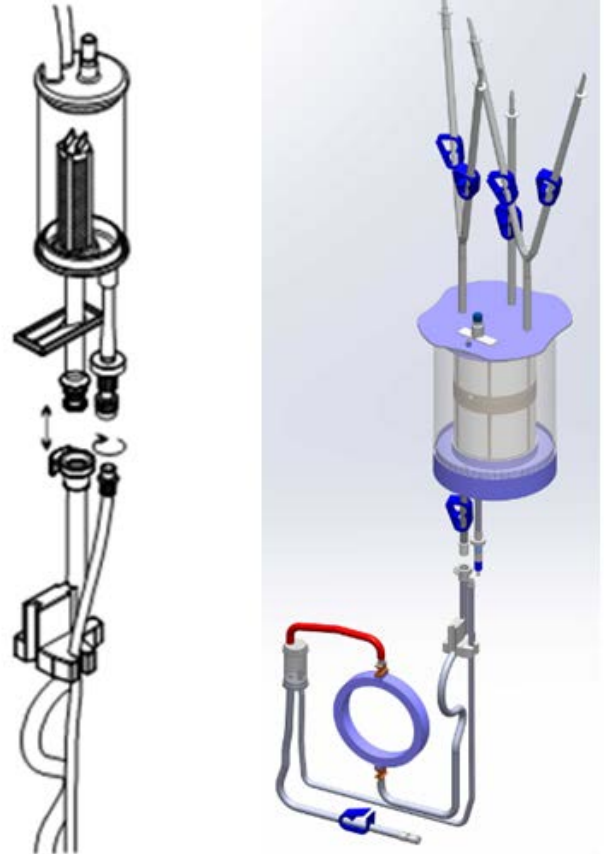

1. Using aseptic techniques, remove the reservoir chamber from the 3-Spike disposable set by disconnecting the luer connectors.
 - Disconnect the larger pump tubing by pressing in the luer lock tab and pulling out the connector.
 - Disconnect the thinner recirculate line by unscrewing the connector.
2. Attach the large reservoir holder onto the IV pole and place the reservoir into the holder.
3. Assemble the large reservoir using aseptic techniques by attaching the three fluid supply tails onto the top of the reservoir.
4. Connect the large reservoir to the fitting of the 3-Spike disposable set.
5. Adjust the reservoir holder to make sure that the two connection leads underneath the reservoir are not stretched or kinked.

Stretched or kinked connection leads can cause flow restrictions and frequent Fluid Out alarms.

POWER ON

- Check that the detachable power cable is securely seated in the main power receptacle.
- Plug the system power cord into a dedicated-grounded, 3-prong, 20 Amp, AC receptacle. Do not use an adaptor for ungrounded outlets.



Power-Up Screen

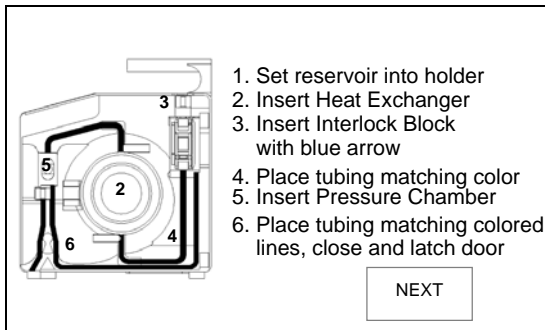

Installation Screen

INSTALLING FLUID BAG

Install solution compatible with blood for the main system prime.

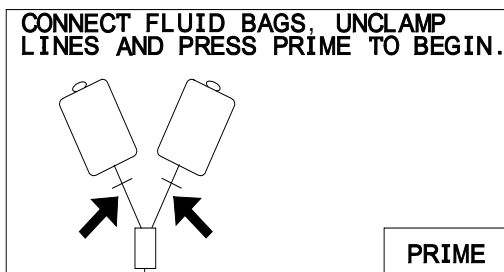

Prime Screen

1. Turn power on by firmly pressing the circuit breaker to the ON position. The system will perform a self-check to check the integrity of system parameters.
2. AC POWER PRESENT appears at the logo screen when the system first powers up. Check the power cord and AC receptacle connections if the statement does not appear.
3. PRIME screen will appear.
4. Press NEXT to go to the PRIME screen.
 - If screen language is not your preferred language, turn power off and back on.
 - Press SERVICE to go to CALIBRATION/SETUP screen.
 - Press LANG SETUP → choose your preferred language → NEXT → EXIT SERVICE.
 - If you turn power ON without the disposable set, INSTALLATION screen appears.
 - Open the door and follow instructions on screen to install the disposable set.
 - Close the door. PRIME screen will automatically appear.

1. Hang fluid bag(s) on the IV pole.
2. Completely close bag clamps, remove the bag spike cap(s). Spike fluid bag(s), pierce it fully to ensure that fluids flow freely.
3. Open bag clamps.
 - When hanging the fluid bag above the machine, the pump tubing that is seated in the fluid out detector should not be stretched. Stretching the pump tubing may cause false Fluid Out alarms.
 - The recirculate line must not be kinked or restricted.

PRIME THE MAIN SYSTEM

Prime the main system with solution compatible with blood. Do not prime with blood.

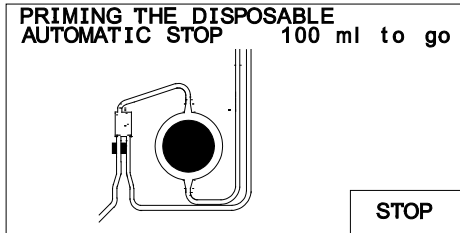

System Priming Screen

CAUTION:

Immediately wipe any spills from the device

1. Press PRIME to recirculate 100 ml of fluid at 500 ml/min to remove air and replace the main system with fluid.
2. The prime volume, 100 ml, countdown is displayed on the screen. Stop automatically when countdown reaches 0 ml. SYSTEM PRIMED screen appears.
 - If after 30 seconds and the prime volume remains at 100 ml, the system will stop, alarm and instruct the user to unclamp the lines and resume prime.
 - If prime has to be stopped, press STOP. The prime volume countdown will remain on the screen. Press RESUME PRIME to continue prime.

PRIME THE PATIENT LINE

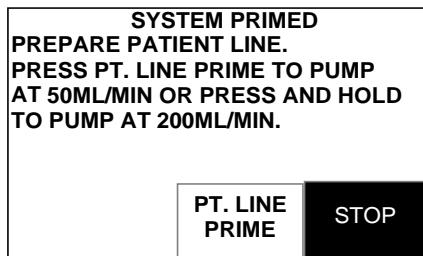

System Primed Screen

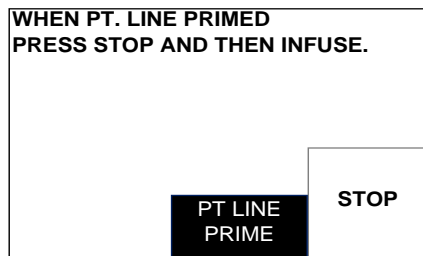

Patient Line Primed Screen

To remove air from the patient line.

1. Open the roller clamp and remove the luer cap from the patient line.
2. Press PT. LINE PRIME
Press once, prime at 50 ml/min. Press and hold, prime at 200 ml/min.
3. Press STOP after no air in patient line.

WARNING!

Before continuing, you must inspect and make certain that the patient line is completely primed and free of air. Any air bubbles after the valve wand in the patient line must be removed before the procedure can safely continue.

CONNECT TO THE PATIENT

Match infusion set to flow rate and fluid type, see chart.

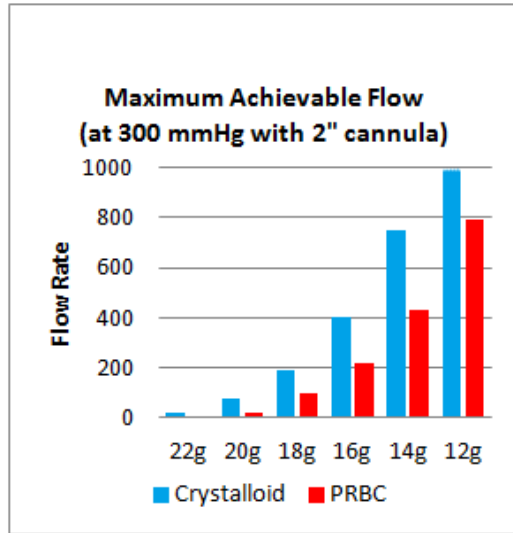

1. Select an appropriate cannula size for decided flow rate.
2. Using aseptic technique, make patient connection without entrapping air.

CAUTION:

A single dedicated intravenous access should be used exclusively for infusing blood components and solutions compatible with blood.

INITIATING INFUSION

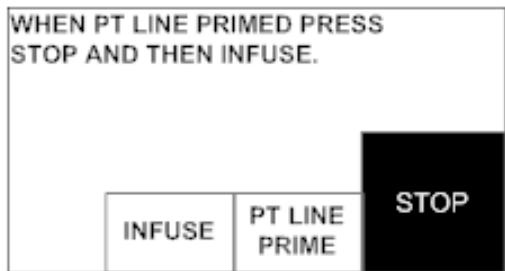

Patient Line Primed and Infuse Screen

SET RATE = 500 ml/min	INFUSING
ACTUAL RATE = 500 ml/min	T = 37.3°C
VOL = 16.2 L	P = 125 mmHg
INFUSE RATE ▲ 500 ml/min	BOLUS 200 ml
INFUSE RATE ▼ 500 ml/min	RECIRC
STOP	

Infuse Screen

1. Press INFUSE to start infusing at 10 ml/min.
2. Press 500 ML/MIN key to infuse at 500 ml/min or adjust flow rate, as needed, by pressing INFUSE RATE • /INFUSE RATE – key (increase/decrease by 10 ml/min).

WARNING:

Do not mix lactated Ringer's or other solutions containing calcium with citrated blood products.

Use only anticoagulated blood products.

MAINTAIN INFUSION

SET RATE = 500 ml/min	INFUSING 		
ACTUAL RATE = 500 ml/min	T = 37.3°C		
VOL = 16.2 L	P = 125 mmHg		
INFUSE RATE ▲	500 ml/min RATE	BOLUS 200 ml	STOP
INFUSE RATE ▼		RECIRC	

Infuse Screen

Routinely check patient and system parameters, on screen. Respond to and correct system alarms.

CAUTION:

Replace reservoir chamber or disposable set when the filter becomes clogged. If it becomes occluded the fluid out sensor will activate, an audible alarm will sound, a message “Fluid Out, Check inlet tubing and Filter. Add more fluid” will appear and the pump will stop.

- Pressure Control**

Regulate the pump speed to keep line pressure under the user-set pressure limit.

SET RATE = 500 ml/min	Infusing-Pressure Control Press Set Rate to match Actual Rate 		
ACTUAL RATE = 140 ml/min	T = 37.3°C		
VOL = 16.2 L	P = 298 mmHg		
INFUSE RATE ▲	500 ml/min RATE	BOLUS 200 ml	STOP
INFUSE RATE ▼		RECIRC	

Pressure Control Screen

The pressure limit is set at the factory to the maximum limit of 300 mmHg. Limit can be changed, see Chapter 4, page 26.

While the system is under pressure control, the system displays “Infusing-Pressure Control. Press Set Rate to match Actual Rate” message, pressure status line flashes and alarm beeps at 10 seconds interval.

Pressure control is due mainly to the small orifice of the infusion set or any occlusions in the line.

To eliminate the pressure control, press SET RATE key to match the actual rate that the system is able to maintain without alarm or use a proper size cannula, **see chart to match infusion set to flow rate and fluid type**, page 10.

- Automatic Air Purging**

SET RATE = 500 ml/min	REMOVING AIR 		
ACTUAL RATE = 500 ml/min	T = 37.3°C		
VOL = 16.2 L	P = 125 mmHg		
INFUSE RATE ▲	500 ml/min RATE	BOLUS 200 ml	STOP
INFUSE RATE ▼		RECIRC	

Automatic Air Purging Screen

After every 500 ml of fluid infused, the system automatically purges air from the system by closing the infusion line and opening the recirculation line for a few seconds.

The recirculate rate is temporarily set to 500 ml/min, if the flow rate is at or below 500 ml/min, and at the actual flow rate, if the flow rate is above 500 ml/min.

The RATE status line displays REMOVING AIR during this process. The volume readout (VOL) remains unchanged during automatic air purging and resumes counting when infusion resumes.

When infusion resumes, the system returns to the previously set rate.

• **Bolus**

SET RATE = 200 ml/min		INFUSING 	
ACTUAL RATE = 200 ml/min		T = 37.3°C	
BOL = 200 ml		P = 125 mmHg	
INFUSE RATE ▲	500 ml/min RATE	200 ml 10 ml	STOP
INFUSE RATE ▼		RECIRC	

Bolus Screen

Deliver fixed volume, factory set to 200 ml, at a rate of 200 ml/min.

To change the flow rate during the bolus infusion, press the INFUSE RATE • or INFUSE RATE – or 500 ml/min RATE key.

Bolus volume can be changed in the Parameters Set-Up screen (Chapter 4, page 26) or by pressing and holding the BOLUS key in the Infuse screen. The new bolus volume will appear in the VOL (volume) status line with the prefix of BOL (bolus). Releasing the Bolus key will start the infusion.

Two sets of numbers are displayed within the BOLUS key space. The top number is the bolus value set and the bottom number is the volume pumped, and is counting up from 0 to the volume set on the key. At the end of the bolus volume, the system beeps and returns to the previously selected flow rate if the previous rate was 50 ml/min or lower. If the previous rate was higher than 50 ml/min, the flow rate will be set to 50 ml/min.

• **RECIRC**

SET RATE = 200 ml/min		RECIRCULATING 	
ACTUAL RATE = 200 ml/min		T = 37.3°C	
VOL = 16.2 L		P = 125 mmHg	
INFUSE RATE ▲	500 ml/min RATE	BOLUS 200 ml	STOP
INFUSE RATE ▼		RECIRC	

Recirculation Screen

Recirculate fluid, warm, and remove air in the main system at a preset rate of 200 ml/min. Recirculation automatically stops and beeps after 5 minutes.

WARNING:

Excessive or prolonged recirculation may damage red blood cells by exposing them repeatedly to the rollers inside the pump head.

• **STOP**

Temporarily halts pumping and heating. Status display continues to be active.

BATTERY OPERATION

SET RATE = 50 ml/min	INFUSING 		
ACTUAL RATE = 50 ml/min	BATTERY NO HEATING		
VOL = 16.2 L	P = 125 mmHg		
INFUSE RATE ▲	50 ml/min RATE	BOLUS 200 ml	STOP
INFUSE RATE ▼		RECIRC	

Battery Operation Screen

CAUTION

Battery operation should be used only briefly or at very low flow rates because there is no heating.

1. Press RECIRC key to preheat fluid in the reservoir chamber.
2. Unplug the system from the wall outlet. The status line that displays temperature will be flashing BATTERY NO HEATING to indicate the system is now in battery mode, the maximum flow rate is 50 ml/min, and heating is suspended.
3. Adjust the flow rate by pressing INFUSE RATE • or INFUSE RATE – or press 50 ML/MIN to immediately set the infuse rate to the maximum rate of 50 ml/min.
4. When the system is plugged back to the AC outlet, the flow rate stays at 50 ml/min if the previous flow rate was greater than 50 ml/min. The system will return to the previous flow rate if the previous rate was 50 ml/min or lower.
5. The normal running time in battery is at least 30 minutes.

LOW BATTERY

When the battery runs low, the system will display BATT LOW message and sound an audible alarm. The system should be plugged into an AC outlet to continue operation and charge the battery.

The normal recharge time is 8 hours.

ACCIDENTAL POWER OFF

SET RATE = 0 ml/min		
ACTUAL RATE = 0 ml/min	T = 37.3°C	
VOL = 16.2 L	P = 125 mmHg	
PLEASE STOP THE PUMP BEFORE TURNING THE POWER OFF. TURN THE CIRCUIT BREAKER BACK ON.		POWER OFF

Accidental Power Off Screen

If the circuit breaker was turned to the STANDBY position while the system is pumping, the system will stop pumping, and alarm. This message is to protect the system from being accidentally powered down during a procedure.

To power off the system, press POWER OFF key, on screen.

To continue with the procedure, turn the circuit breaker back to the ON position and resume operation.

<p>END OF PROCEDURE</p> <p style="text-align: center;">CAUTION:</p> <p>With fluid in the disposable set and the system not powered on, keep the patient line clamped closed when opening the door to prevent uncontrolled fluid flow.</p>	<ol style="list-style-type: none"> 1. If the pump is on, press STOP. 2. Clamp off the patient line and bag spikes. 3. Turn the system to STANDBY, using the circuit breaker. 4. Open the door and remove the disposable set from the system. Practice standard hospital policy when handling and disposing the bio-hazardous materials. 5. Follow the cleaning procedures outlined in Chapter 4, page 28 to clean and disinfect the system.
<p>EMERGENCY MANUAL OPERATION</p> <p>In the event the system is not operational during a procedure, fluid can be infused manually on an emergency basis using pressure or gravity.</p> <p style="text-align: center;">WARNING!</p> <p>In emergency manual operation, all safety features of the system have been bypassed. Monitor the patient line to insure that air is not allowed to enter the patient. Do not apply excessive force on the fluid bag to avoid rupturing the disposable set or damaging blood cells.</p>	<ol style="list-style-type: none"> 1. Bypass the system by switching to STANDBY on the circuit breaker. 2. Open the door to allow the fluid to bypass the roller pump. 3. Remove the infuse line from the valve wand. The rest of the disposable set may be left intact in the instrument or may be removed. 4. Open bag clamps and patient line. Apply pressure at the fluid bag to aid flow. <p>To avoid rupture the disposable set or damaging blood cells, do not use excessive force on the bag.</p>

ALARMS AND TROUBLESHOOTING GUIDE

This chapter describes possible causes for alarm messages with suggestions for corrective actions. When the RI-2 recognizes a situation that is compromising effective infusing, it stops pumping, heating, moves the valve wand into recirculate position, displays alarm message, instructions for corrective measure, and sounds an audible alarm. To mute an alarm and return to normal operation, select the MUTE key on the alarm message screen and follow the on-screen instructions. When the MUTE key has been selected it will appear to be highlighted on the display screen.

A. OPERATIONAL ALARMS

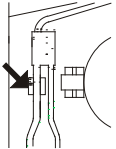
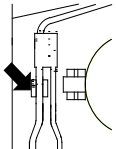
ALARM MESSAGE	POSSIBLE CONDITION	OPERATOR ACTION
<p>AIR DETECTION</p> <div data-bbox="300 863 719 1075" style="border: 1px solid black; padding: 5px;"> <p>AIR DETECTION, OPEN THE DOOR, SQUEEZE TUBING BELOW DETECTOR TO CLEAR TRAPPED AIR, REINSERT TUBING AND CLOSE THE DOOR.</p>  <p>MUTE</p> </div> <p>Air Detection Alarm Message Screen</p> <div data-bbox="311 1245 721 1457" style="border: 1px solid black; padding: 5px;"> <p>PRESS REPRIME TO CLEAR.</p>  <p>REPRIME STOP</p> </div> <p>Reprime Screen</p>	<p>Air in the line.</p> <p>Tubing in the air detection sensor is not seated firmly in the detector.</p> <p>Leak in the disposable.</p> <p>Air detector sensor dirty.</p> <p>Air detector electronics defective.</p>	<p>Open the door to silence the alarm.</p> <p>Check for air bubbles and possible leaks.</p> <p>Squeeze the tubing directly below air detector to clear any trapped air out of the sensor. There should be no trapped air remaining within the air detector.</p> <p>Check the air detector and make certain that it is clean and nothing is obstructing the sensor.</p> <p>Reseat the tubing in the air detector and make certain that it is seated firmly in the sensor.</p> <p>Press REPRIME to reprime main system. If the system does not complete the reprime because the filter in the reservoir chamber is clogged, replace the reservoir chamber or the disposable set and reprime. The system will resume infusion upon completion of the Reprime.</p> <p>Power off and service the machine if error persists.</p>

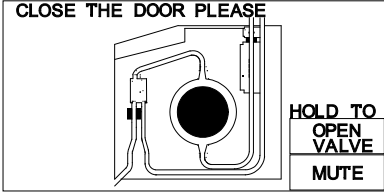
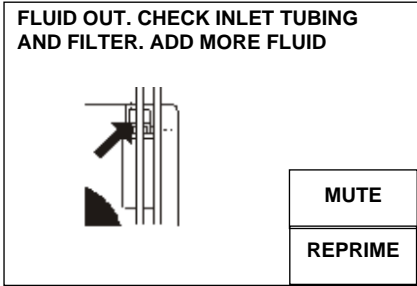
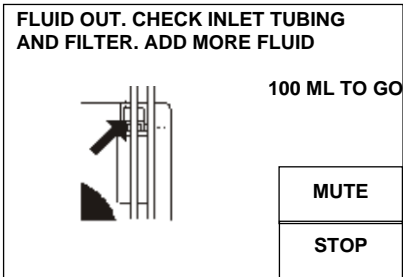
<p>DOOR OPEN</p>  <p>Door Open Alarm Screen</p>	<p>The door is open.</p> <p>No magnet in the door latch.</p>	<p>Close the door to silence the alarm and resume.</p> <p>Check magnet in the door latch.</p> <p>If the door is opened while the system is pumping, the system will immediately stop heating and pumping. The valve moves to the recirculate position and an audible alarm sounds.</p>
<p>FLUID OUT</p>  <p>Fluid Out Alarm Screen</p>  <p>Fluid Out Message after Pressing REPRIME Screen</p>	<p>Out of fluid.</p> <p>Bag clamps not fully opened or fully spiked.</p> <p>Tubing in the Fluid out sensor is not seated firmly in the detector, or tubing is stretched or pulls away from the sensor, due to vacuum in the line.</p> <p>Clogged air vent filter or coarse blood filter.</p> <p>Reservoir or recirculate line is obstructed.</p> <p>Detector electronics defective.</p>	<p>Press MUTE to silence the alarm.</p> <p>If out of fluid, add additional fluid and press REPRIME.</p> <p>Open bag clamp or fully spike the bag.</p> <p>Reseat the tubing in the fluid out detector and make certain that it is seated firmly in the sensor.</p> <p>If the reservoir chamber stays empty during reprime, the air vent filter, on top of the reservoir chamber, may be clogged. In this case, pierce the fluid bag(s) with <u>bag spikes</u> and fully open <u>clamps</u> to allow the air in the reservoir chamber to escape into fluid bag(s) and allow fluid to fill the reservoir chamber.</p> <p>High amounts of particulates in the blood may clog the coarse blood filter in the reservoir chamber. Replace reservoir chamber or disposable if it is clogged.</p> <p>Power off and service the machine if error persists.</p>

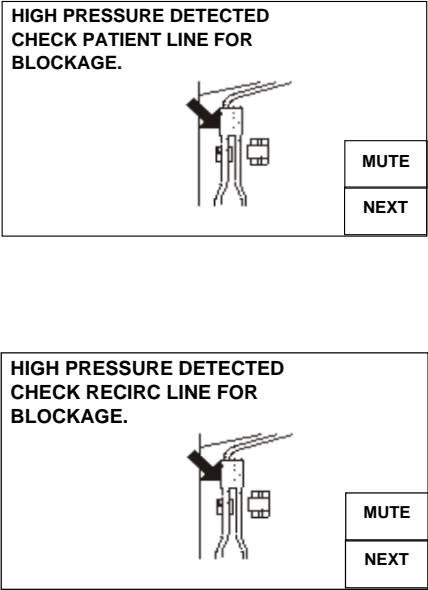
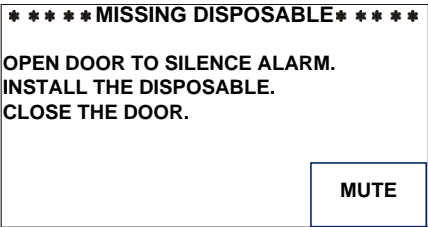
ALARM MESSAGE	POSSIBLE CONDITION	OPERATOR ACTION
<p>HIGH PRESSURE</p>  <p>High Pressure Alarm Screen</p>	<p>Patient line is blocked.</p> <p>Recirculate line is blocked.</p> <p>Infusion site is not well placed.</p> <p>The catheter bore size is too small.</p> <p>Pressure limit setting is set too low.</p>	<p>Make certain that the flow path is not blocked.</p> <p>Check that the recirculate line is not obstructed.</p> <p>Check that the infusion site is well placed and use the appropriate infusion set recommended in the guide, <u>Match the Infusion Set to Flow Rate and Fluid Type</u> on page 10.</p> <p>Increase pressure limit setting.</p> <p>Press NEXT to silence the alarm and resume.</p> <p>Check functionality of the pressure transducer by gently pressing the transducer. Pressure reading on screen should change. If not, it is defective, service machine.</p>
<p>LOW BATTERY</p> <p>Plug the system into an AC outlet to continue operation and recharge the battery. Allow at least 8 hours to fully charge the battery.</p>	<p>Battery voltage is too low</p>	<p>If LOW BATTERY displayed while the system is connected to AC power, one of the components may be defective. Service machine.</p> <p>If battery is completely discharged, turn the AC power OFF, plug the system into an AC outlet to recharge the battery. Wait for at least 30 seconds before turning the system ON.</p>
<p>MISSING DISPOSABLE</p>  <p>Missing Disposable Screen</p>	<p>No disposable set in the unit.</p>	<p>Properly install disposable.</p> <p>Press NEXT to resume.</p>

B. HEATING ALARMS:

Heating alarms which may occur are:

ALARM MESSAGE	POSSIBLE CONDITION	OPERATOR ACTION
<p>SYSTEM ERROR #101 CHECK TEMPERATURE PROBES FOR BLOCKAGE. CLEAN WINDOWS. PRESS RETRY TO CONTINUE. SERVICE MACHINE IF ERROR PERSISTS.</p>	<p>Wet, dirty or blocked disposable set windows. Wet, dirty or blocked IR probe. IR probe failure. Heater fault</p>	<p>Check disposable set and flow path for occlusions. Make certain the windows on the disposable set and the IR probes are clean and dry. Clean surfaces with moistened soft cloth if necessary. Dry off surfaces before continuing. Press RETRY to continue. Power off and service machine if error persists.</p>
<p>SYSTEM ERROR #102 INFUSATE OVER TEMPERATURE. DISCARD DISPOSABLE AND BLOOD. RESTART SYSTEM WITH A NEW DISPOSABLE. SERVICE MACHINE IF ERROR PERSISTS.</p>	<p>Fluid supply is over the temperature limit Temperature probes are wet, dirty, or blocked. Restricted flow or out of fluid.</p>	<p>Check disposable set and flow path for occlusions. Make certain the windows on the disposable set and the IR probes are clean and dry. Clean surfaces with moistened soft cloth if necessary. Dry off surfaces before continuing. Make sure bag clamps are open and flow is unimpeded. Make sure that the filter is not clogged. Add more fluid, if fluid out. Clamp off the bag spikes and patient line and remove disposable. Power off and restart system with a new disposable. Service machine if the problem persists. WARNING! Do not infuse blood that is in the disposable set when over temperature condition occurs. Red cells that have been subjected to high temperature may not be safe to infuse.</p>

C. HARDWARE ALARMS:

ALARM MESSAGE	POSSIBLE CONDITION	OPERATOR ACTION
SYSTEM ERROR #201 POWER OFF AND RESTART. SERVICE MACHINE IF ERROR PERSISTS.	Air detector failure	Power off and restart. Service machine if error persists.
SYSTEM ERROR #202 POWER OFF AND RESTART. SERVICE MACHINE IF ERROR PERSISTS.	Fluid out detector failure	Power off and restart. Service machine if error persists.
SYSTEM ERROR #203 PRESS RETRY TO CONTINUE. SERVICE MACHINE IF ERROR PERSISTS.	Excessive AC power line noise or internal failure	Press RETRY to try again. Power off and restart. Service machine if error persists.
SYSTEM ERROR #204 POWER OFF AND RESTART. SERVICE MACHINE IF ERROR PERSISTS.	Heater power feedback sense coil open. Power feedback circuit malfunction.	Power off and restart. Service machine if error persists.
SYSTEM ERROR #205 PRESS RETRY TO CONTINUE. SERVICE MACHINE IF ERROR PERSISTS.	Heater hardware fault	Press RETRY to try again. Power off and restart. Service machine if error persists.
SYSTEM ERROR #206 CHECK FOR BLOCKED AIR INTAKE. WAIT FOR THE SYSEM TO COOL. SERVICE MACHINE IF ERROR PERSISTS.	Power driver module overheating	Make certain that the fan air vents at the bottom of the machine are not blocked. Wait for unit to correct problem. Display will return to Infuse screen when the error clears. Press MUTE to silence the alarm. Power off and restart. Service machine if error persists.
SYSTEM ERROR #207 CHECK PUMP FOR BLOCKAGE. PRESS RETRY TO CONTINUE. SERVICE MACHINE IF ERROR PERSISTS.	Pump tubing is installed incorrectly Pump failure Pump speed feedback encoder failure. Pump runs out of control or not at all.	Check that pump tubing is seated on the pump head correctly. Check that pump turns freely and the pump head is clean. Press Retry to try again. Power off and restart. Service machine if error persists.

ALARM MESSAGE	POSSIBLE CONDITION	OPERATOR ACTION
<p>SYSTEM ERROR #208</p> <p>CHECK VALVE FOR BLOCKAGE. POWER OFF AND RESTART. SERVICE MACHINE IF ERROR PERSISTS.</p>	<p>Valve failure</p> <p>Valve position sensor malfunction</p>	<p>Check that the valve is not blocked.</p> <p>Power off and restart. Service machine if error persists.</p> <p>CAUTION:</p> <p>Keep the patient line clamped closed when opening the door to prevent uncontrolled fluid flow.</p>
<p>SYSTEM ERROR #209</p> <p>CHECK FOR BLOCKED AIR INTAKE. WAIT FOR THE SYSEM TO COOL. SERVICE MACHINE IF ERROR PERSISTS.</p>	<p>Printed Circuit Board overheating</p>	<p>Make certain that the fan air vents at the bottom of the machine are not blocked.</p> <p>Wait for unit to correct problem. Display will return to Infuse screen when the error clears.</p> <p>Press MUTE to silence the alarm.</p> <p>Power off and restart. Service machine if error persists.</p>
<p>SYSTEM ERROR #210</p> <p>POWER OFF AND RESTART. SERVICE MACHINE IF ERROR PERSISTS.</p>	<p>Internal computer malfunction</p>	<p>Power off and restart. Service machine if error persists.</p> <p>CAUTION:</p> <p>Keep the patient line clamped closed when opening the door to prevent uncontrolled fluid flow.</p>

TROUBLESHOOTING OTHER OPERATIONAL DIFFICULTIES

Problems may occur that are outside the surveillance system due to improper setup, faulty accessory equipment, or internal failure of a component. Table below describes several of these potential problems, the alarm that might be generated (if any), and the corrective actions to take.

PROBLEM	POSSIBLE CONDITION	OPERATOR ACTION
Battery No Heating	Power cord not plugged in AC power	Plug into AC receptacle; check power cord connection. Keep the system plugged in to charge the battery.
Dim display	Display brightness in Setup Routine has been turned down to the lowest brightness setting.	Increase display brightness in System Setup, Chapter 4, page 26.
Flow rate is slowing down or will not go at the set rate	The system is keeping the pressure in the line under the Pressure Limit by reducing the infusion rate.	<p>Check and remove kinks or obstructions in the tubing.</p> <p>Use the appropriate infusion set recommended in the guide, <u>Match the Infusion Set to Flow Rate and Fluid Type</u>, Chapter 2, page 10.</p> <p>Increase flow by increasing the Pressure Limit. Change the Pressure Limit in Calibration/Setup to a higher limit (maximum Pressure Limit is 300 mm Hg), Chapter 4, page 26.</p>
Keypad does not accept input	<p>The keypad is being continually depressed.</p> <p>Key pad failure</p>	<p>Release the keypad and the constant beep will cease.</p> <p>If the alarm persists, power off and service machine.</p>
Keypad is too sensitive or not responsive	Keypad sensitivity in Setup Routine has been set at Fast or Slow.	Reset keypad sensitivity in System Setup, Chapter 4, page 26.
No message, beep tone	Power switch not completely depressed or membrane switch failed.	Depress power switch completely. If problem persists, replace the membrane switch.
No power or battery run time is too short	<p>Power cord not plugged into AC power.</p> <p>Batteries discharged in DC operation.</p>	<p>Change AC power source; check power cord connections.</p> <p>Recharge internal battery by connecting the power cord to the AC line. If the battery run time is less than ½ hour after a full 8 hour charge, call service to replace the rechargeable battery.</p>

PROBLEM	POSSIBLE CONDITION	OPERATOR ACTION
Power off immediately after switch to ON. System turns on for 2-3 seconds, then turn off automatically	IGBT's on Driver 'A' and 'B' shorted. EPROM is not seated in the socket properly.	If the problem persists, power off and service machine. Service machine.
Pump is running too loud	Roller pump is hitting the door or pump tubing is not properly installed.	1. Open the door and reinsert the pump tubing. 2. Check to make sure that there is no blood or debris around the door hinges caused the door to lift up resulting in the roller pump hitting the door hub.
System does not heat to physiological temperature	Windows on the disposable or IR sensor is wet or dirty. Power module is not calibrated properly. Power module malfunction or temperature probes are out of calibration.	Examine the windows on the disposable set for wetness or contaminants. Clean IR sensor window with soft cloth and alcohol if necessary. The input temperature is too low and the flow rate is too high. Service machine if problem persists.
System does not prime	See Fluid Out in Alarm Message of this chapter	Check the reservoir or recirculate line and make certain that it is not obstructed, the fluid bags are fully spiked and clamps are open. The pump tubing should not be stretched too taut and it must be firmly seated within the sensor. See Fluid Out in Alarm Message of this chapter
Unable to calibrate temperature probes	Temp probe malfunction Incorrect fluid temperature used for calibration.	Check the temperature of fluid and make certain it is correct. If problem persists, service machine.
Unable to turn the system off	One of the components on Daughter Board failed.	Service machine.

PARAMETERS SETTING AND PREVENTIVE MAINTENANCE

The Belmont[®] Rapid Infuser, RI-2, requires minimal service and care. Preventive maintenance should be performed regularly to optimize performance and reduce the likelihood of downtime. Listed below are routine maintenance (as needed), periodic maintenance (at least once a year), and parameters setting. The instrument does not need regular calibration.

WARNING!

Practice standard precautions when handling blood products. Treat all blood as if it were infected and clean up all spills immediately.

WARNING!

Test leakage current routinely to insure against electrical shock hazard.

CAUTION:

Turn the system to STANDBY and unplug the power cord before cleaning to avoid electric shock.

CAUTION:

Immediately wipe any spills from device.

A. SYSTEM SETUP

Changes in system setup can be made to:

- Date and time
- Display brightness
- Key Rate
- Bolus delivery volume
- Pressure limits for High Pressure alarm

Parameter Setup changes is performed in the Service mode.



Pressing the SERVICE key accesses the Calibration/Set-up mode. This key appears on the BELMONT logo screen only at system powered-up. This screen remains active for 4.5 seconds before the system enters the Prime mode.

CALIBRATION/SET-UP			
TIME 23:59		DATE: 12-31-14	
BOLUS 200 ML		PRESS LIMIT 300MMHG	
AC POWER PRESENT			
	DATE TIME	DISPLAY BRIGHT	LANG. SETUP
TEMP CAL	PRESS CAL	POWER CAL	FAST KEYRATE
PRESS LIMIT	HARD- WARE	SETUP BOLUS	EXIT SERVICE

2. Display Brightness

There are four (4) levels of display brightness. Press DISPLAY BRIGHT to change the present level of brightness to the next level.

3. Language Setup

Press this key to set screens to your preferred language.

4. Key Rate

The key rate sets up the sensitivity of the touch keys. There are three different levels of sensitivity; FAST, MEDIUM and SLOW. The current level of sensitivity is indicated on the key itself. The FAST setting requires the least amount of time for a key to respond. The MEDIUM setting requires more time and the SLOW key requires the most time and makes the touch keys least sensitive. **The key sensitivity is set at factory to Medium.**

Note that this key changes the time required to depress a key for stroke to be recognized. The pressure required is not affected.

5. Bolus Volume

The bolus volume can be set from 100 to 1000 ml and can be changed from 100, 200, 400, 500, and 1000 ml each time SETUP BOLUS key is pressed. The current bolus volume is indicated at the BOLUS status line in the Calibration/Setup screen. The bolus volume is also displayed within the BOLUS key in the Infuse screen (see Chapter 2 under Main Infuse screen).

6. Pressure Limit

The user can set the maximum allowable in-line pressure. The possible setting ranges from 100 to 300 mm Hg. The current pressure limit value is displayed on the PRESS LIMIT status line on the Calibration/Set-Up screen. Press and hold the key to change the limit in increments of 50 mm Hg. During infusion, the system keeps the pressure in the line under the pressure limit by reducing the infusion rate as the in-line pressure approaches the pressure limit. **The pressure limit is automatically reset to 300 mm Hg each time that the system is powered on.**

B. SERVICE AND PREVENTIVE MAINTENANCE SCHEDULE

Schedule 1

To be performed by either the Clinical User or a Biomedical Technician (BMET).

Routine Maintenance	Interval		
	Before or After Each Use	Every Month	Every 6 Months
1. Clean and/or Disinfect Exterior, if necessary.	●		
2. Clean Fluid Out and In-Line Air Detector.	●		
3. Check the Power Cord.	●		
4. Clean Temperature Probes	●		
5. Check/Clean the Fan Guard.		●	
6. Check the System Seal.			●
7. Check Instrument Door and Ceramic Disk.			●
8. Check Rubber Feet.			●

Schedule 2

To be performed by either a BMET or other qualified service personnel.

Required Test/Verification	Interval	
	Every 6 Months	Every Year
1. Perform Visual Inspection.	●	
2. Perform System Operational Check-Out, including the Audible Alarm Test.	●	
3. Check the battery for rated voltage and check battery run time. Replace batteries when operating time is marginal or after 3 years.	●	
4. Perform Electrical Safety Test.		●
5. Hardware Verification.		●
6. Clean Pump Head		●

C. ROUTINE MAINTENANCE

1. Clean and/or Disinfect Exterior

Clean the outside surfaces of the system and inside the door after each use.

- a. Turn the pump to STANDBY and unplug the power cord.
- b. Wipe the surface with a cloth moistened with water or isopropyl alcohol.

Note: Avoid the use of acetone or other solvents that might damage the surface.

- c. To remove dried blood and disinfect the pump, clean them with hydrogen peroxide or a mild bleach solution and dry.
- d. Also clean around the door hinges, making sure the door is pushed all the way down inside the hinges.
- e. Do not spray cleaning liquids into or onto the air vents at the bottom of the system.

2. Fluid Out and In-Line Air Detectors

Keep the fluid out and air detectors clean and dry. If they become dirty or wet, clean with a moistened Q-tip and dry. Air detector surfaces are delicate. Use care when carrying out this procedure.

3. Power Cord

Inspect the power cord along its length and connectors for cuts and breaks. Replace power cord if damaged.

4. Temperature Probes

Keep the probe sensors clean and dry. If they become dirty or wet, clean with a moistened Q-tip and dry. Use care not to damage the sensor surface.

5. Fan Guards

Inspect the fan guards, on the bottom of the unit, for debris that might impede air flow. Remove guards by unscrewing the 4 retaining screws and clean, with soap and water, if necessary. Make certain the guards are not damaged. Let the fan guards dry before reinstalling.

6. Seals

Inspect the seal around the unit to make certain it is in good condition. Check also the seal around the touch screen and ceramic disks. Use Dow Corning 732 multipurpose RTV sealant or equivalent if needed to maintain fluid resistance.

7. Instrument Door and Ceramic Disks

The instrument door must fit properly for the system to operate correctly. The platen part of the roller pump is located on the door. The platen must line up properly with the pump.

- a. Check hinges for blood build-up, clean any dried blood from hinge area. Be sure that door is seated completely down on the hinges.
- b. Check plastic rivets and door integrity. Make sure that the door frame is not bent. Replace, if bent.
- c. Inspect the ceramic disks on the door and in the center of the unit for cracks. Return to manufacturer for replacement if they are damaged.

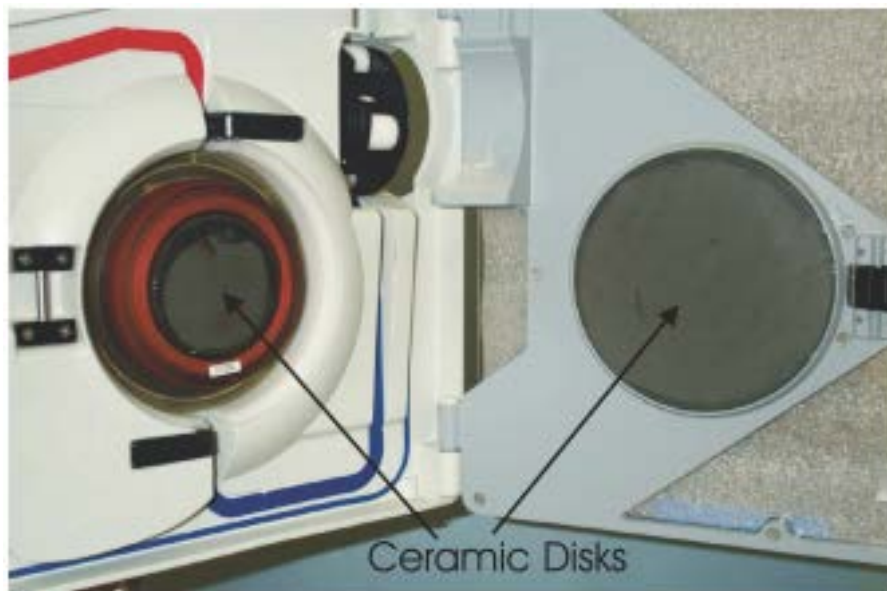

8. Rubber Feet

Inspect the rubber feet on the bottom of the unit for cracked or missing rubber feet. Replace if necessary.

D. TEST/SYSTEM OPERATIONAL CHECK-OUT

The device should be serviced periodically, in accordance to schedule 1 and 2, by a qualified technician.

Material Required:

- Rapid Infuser Disposable Set, REF 903-00006
- Bio-Tek Safety Analyzer or equivalent
- Saline or other crystalloid for testing
- 2 liters of 35° - 42°C fluid
- Manometer (2 mm Hg resolution)
- Pressure source
- Thermometer with thermocouple (0.1°C resolution)
- Graduated cylinders (ASTM Class B accuracy)
- Timer
- Tachometer (optional)

1. Visual Inspection

- a. Door Open/Right Hand Side:
 - i. Check that air and fluid out detectors are clean.
 - ii. Check that all the plastic push pins on the door are in-place.
 - iii. Check that the valve pincher set screw is tight.
 - iv. Check that there are no cracks in the ferrite on either the door or the right hand side.
 - v. Check that the pressure transducer diaphragm has no tears or rips.
 - vi. Check that each pump roller spins freely. If not, remove and clean.
 - vii. Check that the door is pushed all the way down and there is no dried blood or fluid inside or around the hinges.
- b. Back:
 - i. Check that the AC connector (IEC connector) is clean. If there is some saline residue, clean.
- c. Verify Latch/Unlatch Mechanism:
 - i. Check the rubber pads on the pole clamp assembly. If they feel slick/polished, clean and scrub with isopropyl alcohol.
 - ii. Mount and un-mount the system on an IV pole, verify that the latch and unlatch work properly and the system will not move down the pole unexpectedly.

2. System Operational Check-Out

- a. Install Disposable set.
- b. Turn power switch ON. Wait for PRIME screen to appear.
- c. Close bag clamps. Hang and spike fluid bag.
- d. Open bag clamp(s). Press PRIME to prime the system (circulate 100 ml of fluid at 500 ml/min.) Prime volume (100 ml) countdown is displayed on screen. Stop automatically when countdown reaches 0 ml.
- e. Press PT. LINE PRIME once to pump at 50 ml/min or press and hold to pump at 200 ml/min. Press STOP when line is free of air bubbles.
- f. Press INFUSE to start infusion at 10 ml/min. Press INFUSE RATE ▲▼ to change flow rate.
- g. Increase flow rate to 500 ml/min and verify that the output temperature, on the display, is $37.5^{\circ} \pm 1^{\circ}\text{C}$.
- h. Remove the power cord. Verify that the system automatically switches to battery when AC is disconnected. BATTERY NO HEATING message displays to indicate the system is now in battery mode and heating is suspended.
- i. Connect back to AC power and verify the operation is uninterrupted. Adjust the flow rate by pressing INFUSE RATE ▲▼.
- j. Infuse until the fluid bag is empty, verify that the system stops pumping and sounds an audible alarm with 'FLUID OUT' message displays on screen.

3. Battery Run Time Test

- a. Prior to performing the battery run test, plug the system into an AC wall outlet for at least 8 hours to fully charge the batteries.
- b. Follow directions in Step 2, a-g. Infuse at 50 ml/min. Start the timer.
- c. The system should run for at least 30 minutes with fully charged battery. If not, replace the batteries.

4. **Electrical Safety Test - Leakage Current**

Equipment required: Fluke Safety Analyzer, Model 505 or equivalent
2 Liters of room temperature saline

Setup: Plug the RI-2 into AC outlet on the panel of the Safety Analyzer.

CAUTION:

Before applying voltage to Safety Analyzer, make sure input line voltage is correct for the **VOLTAGE OF UNIT UNDER TEST**.

a. **Earth Leakage Currents:**

- i. Plug the Safety Analyzer into an appropriate power source, turn Analyzer power ON. Turn the RI-2 power switch to Standby.
- ii. Switch selector on Analyzer to CHASSIS or LEAKAGE (μA). Connect a single red lead to the SINGLE LEAD input jack, and attach large clamp to equipotential ground terminal on the RI-2.
- iii. Record the leakage current displayed for each of the following conditions, with Neutral switch in NORM position. Tests should be performed in the following order.

Polarity - NORM;	Ground – NORM
Polarity - REVERSE;	Ground – NORM
Polarity - REVERSE;	Ground – OPEN
Polarity - NORM;	Ground - OPEN
- iv. Repeat the first two (Normal Polarity and Reverse Polarity - Grounded) with Neutral switch in OPEN position.
- v. Install the disposable set and prime with saline and proceed to the Infuse screen. Press STOP to set the pump at 0 ml/min, not heating or pumping.
- vi. Repeat iii & iv with the RI-2 in ON mode (power switch ON, infuse screen displayed, not pumping or heating).
- vii. Repeat iii & iv with the RI-2 infusing and heating at maximum rate.
- viii. All measurements should be $<300 \mu\text{A}$ (for Domestic unit) and $<500 \mu\text{A}$ (for 230 V unit).

b. **Patient Leakage Current:**

- i. Install the disposable set and prime with saline and proceed to the Infuse screen.
- ii. Attach 12 to 16 gauge stainless steel cannula or hypodermic needle tip to the end of patient line and attach the Safety Analyzer large clamp to the cannula or needle tip.
- iii. Prime the RI-2 with saline. Make sure that the entire patient line including the cannula has been primed.
- iv. Repeat a.iii, and a.iv with the RI-2 in the STANDBY (ON) and pumping at 750 ml/min modes.
- v. Maximum leakage allowable is as follows:

With NORMAL NEUTRAL

Normal Polarity - Grounded (10 μ A)

Reverse Polarity - Grounded (10 μ A)

Reverse Polarity - Not Grounded (50 μ A)

Normal Polarity - Not Grounded (50 μ A)

With OPEN NEUTRAL (Note: the system automatically switches to battery at 50 ml/min.)

Normal Polarity - Grounded (50 μ A)

Reverse Polarity - Grounded (50 μ A)

5. **Hardware Verification**

Install and prime the disposable set before beginning the Hardware Verification process.

Hardware mode verifies:

- a. Valve operation
- b. Fluid Out and Air Detectors
- c. Battery voltage.
- d. Flow Rate (Pump speed)
- e. Input and Output Temperature Probes including "Over Temperature" alarm test, and
- f. Pressure sensor.

A password is required to access the SERVICE screen, to insure that this mode is not accessed accidentally.

Press the SERVICE key, at power-up, to access the Calibration/Set-up screen. This screen remains active for 4.5 seconds before the system enters the Prime mode screen.

WARNING!

Do not access hardware verification while the instrument is patient connected.

- Press HARDWARE from the Calibration/Set-Up screen.
- Enter the Password 013192.

CALIBRATION/SET-UP			
TIME 23:59		DATE: 12-31-14	
BOLUS 200 ML		PRESS LIMIT 300MMHG	
AC POWER PRESENT			
	DATE TIME	DISPLAY BRIGHT	LANG. SETUP
TEMP CAL	PRESS CAL	POWER CAL	FAST KEYRATE
PRESS LIMIT	HARD- WARE	SETUP BOLUS	EXIT SERVICE

Calibration/Setup Screen

PUMP SPEED 0 ml/min			
INPUT TEMPERATURE 23.0 (23.0)			
OUTPUT TEMPERATURE 23.0 (23.0)			
PRESSURE 0 mmHg			
FLUID OUT DETECTOR STATUS AIR			
AIR DETECTOR STATUS AIR			
BATTERY VOLTAGE 28.5			
BOARD TEMPERATURE 23 C			
			PUMP SPEED
LEFT VALVE	OPEN VALVE	RIGHT VALVE	CANCEL

Hardware Status Screen

Status Line	Reading
Pump Speed	0, 10, 100, 500, 750, and an optional 1000 ml/min
Input Temperature	Temperature in °C, probe ambient reference in parentheses
Output Temperature	Temperature in °C, probe ambient reference in parentheses
Pressure	Pressure in mmHg
Fluid Out Detector Status	Air or Fluid
Air Detector Status	Air or Fluid
Battery Voltage	Battery charge level in volts
Board Temperature	Temperature of the circuit board inside the case.

Function Key	Action
PUMP SPEED	Change pump speed.
LEFT VALVE	Move the valve to the left or recirculate position.
OPEN VALVE	Move the valve to the middle or load position.
RIGHT VALVE	Move the valve to the right or infuse position.
CANCEL	Exit Hardware status and return to the Calibration/Set-Up screen.

Hardware Verification:

a. Valve

- i. Press LEFT VALVE, confirm that the valve wand (valve pincher) moves to the left.
- ii. Press OPEN VALVE, confirm that valve wand moves to the middle position.
- iii. Press RIGHT VALVE, confirm that the valve wand moves to the right. Leave the valve in the LEFT VALVE position before continuing to the next step.

b. Fluid Out and Air Detectors

- i. Confirm that the Fluid Out Detector and the Air Detector status lines display FLUID when the system is primed and no air is in the detectors.
- ii. Open the door and pull out the tubing from the detectors. Close the door and confirm that the status line display AIR when the tubing is removed from the sensor.

c. Battery Voltage

Unplug the unit from the wall outlet. 'Battery voltage' displayed in HARDWARE screen, should be approximately 24 volts. If not, recharge the battery for at least 8 hours and recheck. Plug the unit back into the wall outlet.

d. Flow Rate

The flow rate can be verified by actually measuring the flow using a graduated cylinder and timer or by using a tachometer. Choose the method that best serves your setup.

Directly measure the flow:

- i. Make certain the patient line and entire disposable is fully primed before measuring. Set the pump speed to 10 ml/min. Press RIGHT VALVE to set the valve into the infuse position and fill the patient line. Use a graduated cylinder to measure flow at the patient line for ten minutes and verify the average flow rate over that period. The volume collected should be 100 ± 25 ml for an averaged flow rate of 10 ± 2.5 ml/min.
- ii. Press PUMP SPEED again to change the pump speed to 100 ml/min and measure the flow with a graduated cylinder for one minute. The accepted tolerance is 100 ± 10 ml/min.
- iii. Press once more to change speed to 500 ml/min and repeat the measurement. The accepted tolerance is 500 ± 50 ml/min.
- iv. Press once more to change speed to 750 ml/min and repeat the measurement. The accepted tolerance is 750 ± 75 ml/min.
- v. For 1000 ml/min option, press once more to change speed to 1000 ml/min and repeat the measurement. The accepted tolerance is 1000 ± 100 ml/min.

Measure by using a tachometer, optional:

- i. Close the door. Set the pump speed to 10 ml/min. Use a tachometer to measure the rotational speed of the pump head. The accepted tolerance is $1.95 \text{ rpm} \pm 25\%$.
- ii. Press PUMP SPEED again to change the pump speed to 100 ml/min. The accepted tolerance is $19.65 \text{ rpm} \pm 10\%$.
- iii. Press once more to change speed to 500 ml/min and repeat the measurement. The accepted tolerance is $97 \text{ rpm} \pm 10\%$.
- iv. Press once more to change speed to 750 ml/min and repeat the measurement. The accepted tolerance is $146 \text{ rpm} \pm 10\%$.
- v. For 1000 ml/min option, press once more to change speed to 1000 ml/min and repeat the measurement. The accepted tolerance is $195 \text{ rpm} \pm 10\%$.

e. Input and Output Temperature Probes and “Over Temperature” Alarm

Prepare at least 2 liters of $37^{\circ} - 43^{\circ}\text{C}$ fluid

- i. Connect the fluid supply to the disposable. Remove the patient line from the luer connector. Insert the thermocouple approximately 2” into the connector previously connected to the patient line.
- ii. Press the RIGHT VALVE key to set the valve to the infuse position. Open the fluid supply and set the pump speed to 500 ml/min.
- iii. Let the temperature stabilize, wait at least 2 minutes. The INPUT TEMPERATURE and OUTPUT TEMPERATURE value readings (the values not between the parentheses) should be within (2°C).
- iv. Compare the numbers displayed, on screen, to the thermocouple reading. The accepted tolerance is 1°C for fluid temperature between 30°C to 40°C and 2°C outside this range.
- v. Press PUMP SPEED to set the pump speed back to 0 ml/min.
- vi. Press CANCEL to return to the Calibration/Set-Up screen.
- vii. Press EXIT SERVICE to return to PRIME screen.
- viii. Prime the unit and the patient line with room temperature water.

Prepare at least 2 liters of $43^{\circ} - 45^{\circ}\text{C}$ fluid.

- ix. Connect this fluid supply to the disposable. Infuse at 500 ml/min.
- x. Compare the numbers displayed, on screen, to the thermocouple reading. The alarm sounds when the screen reads between $42^{\circ} - 42.5^{\circ}\text{C}$.
- xi. Record the temperature when the “Over Temperature” alarm occurs. The accepted tolerance of the temperature between the thermocouple and on the screen should be within 1° to 2°C of each other.

f. Pressure Transducer

WARNING!

Do not apply excessive pressure to the pressure chamber or pressure transducer. The pressure transducer is a precision electromechanical device and can be damaged with excessive force. **Do not use the system if the pressure transducer is damaged.**

- i. **Inspect the pressure transducer for damage. Make certain the surface of the transducer is not cut or punctured. The pressure transducer must be replaced if the surface is damaged.**
- ii. Make certain the pressure chamber is properly installed (see Chapter 2: Installing the Disposable) and the flow path is not blocked.
- iii. Make certain the fluid is warm (37° – 42°C). The pressure chamber of the disposable is less compliant when it is at room temperature. **Verification must be performed with a warm disposable.** If the fluid is not warm, go to the Main Infuse screen and warm the fluid and disposable by pressing the RECIRC key (Chapter 2: Main Operating Screen: Recirculating Mode). Let the fluid recirculated for at least two minutes in AC power before returning to the Hardware mode for verification.
- iv. In the Hardware mode: close the door, the bag clamps and block the air vent on top of the reservoir chamber. Disconnect the patient line and connect the pressure source to the luer fitting at the patient line port of the disposable set and apply pressure while monitoring the amount of pressure with a manometer.
- v. Verify the accuracy of the pressure transducer. Apply 300 mm Hg into the disposable. The pressure status line should read 300 mm Hg (± 50 mm Hg). Repeat the same pressure verification for 200 and 100 mm Hg.

6. Clean Pump Head

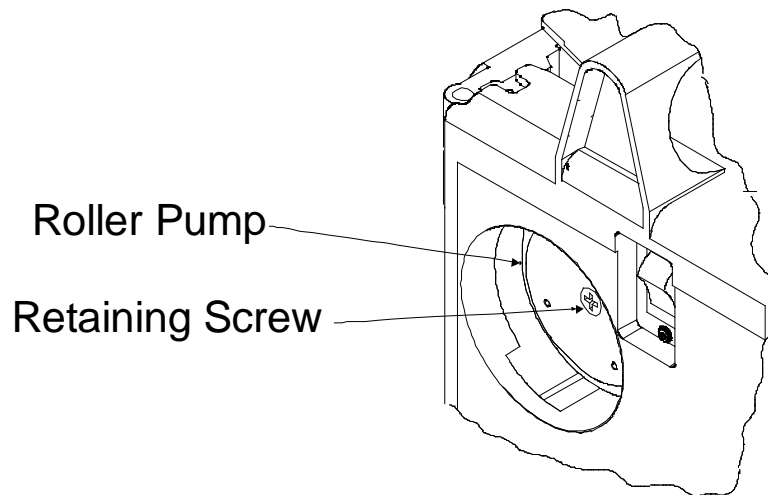

The pump head can be removed and cleaned if needed.

- a. Turn the pump to STANDBY and unplug the power cord.
- b. Unscrew the retaining screw that holds the pump head.
- c. Remove the pump head and clean with water and soap. Hydrogen peroxide or a mild bleach solution can be used to disinfect.
- d. Let pump head dry before replacing and make certain the pump head is securely fastened with the retaining screw.
- e. If the pump head squeaks, spray the roller with Silicone spray (Heavy Duty Pure Silicone.)

E. CHECKLIST

RI-2 S/N:	Tested By:	Date:
-----------	------------	-------

Equipment Used:	Safety Analyzer S/N:		Cal Due Date:
	Pressure Source S/N:		Cal Due Date:
	Thermometer S/N:		Cal Due Date:
	Tachometer S/N:		Cal Due Date:

	Results	
1. Visual Inspection:		
a. Right Hand Side		√ if OK
b. Back		
c. Latch/Unlatch		
2. Operational Check-Out		
d. PRIME		√ if OK
e. PT. LINE PRIME		
f. INFUSE ▲ ▼		
g. Output Temperature @ 500 ml/min		
h. AC to DC switch over		
i. DC to AC switch		
j. FLUID OUT audible alarm		
3. Battery Run Time test		>30 min.
4. Electrical Safety Check (See attached Results Sheet)		
a. Earth Leakage Current		√ if OK
b. Patient Leakage Current		
5. Hardware verification:		
a. Valve Operation		√ if OK
b. Fluid Out and Air Detectors		√ if OK
c. Battery Voltage		approx. 24 V
d. Flow Rate		√ if OK
e. Input and Output Temperature Probes		√ if OK
Temp. when "Over Temp" alarm: On screen Thermocouple		42° to 42.5°C 1° to 2°C of screen
f. Pressure Sensor		√ if OK
6. Clean Pump Head		√ if done

Electrical Safety Test - Leakage Current Results Sheet

a. **Earth Leakage Currents** (all measurements are in μA)

	Polarity - N; Ground - N	Polarity - R; Ground - N	Polarity - R; Ground - O	Polarity - N; Ground - O
Unit in STANDBY				
• Neutral - NORM				
• Neutral - OPEN				
Unit in ON, not pumping				
▪ Neutral - NORM				
▪ Neutral - OPEN				
Unit in ON, infusing @ 750 ml/min.				
• Neutral - NORM				
• Neutral - OPEN				

b. **Patient Leakage Currents** (all measurements are in μA)

	Polarity - N; Ground - N	Polarity - R; Ground - N	Polarity - R; Ground - O	Polarity - N; Ground - O
Unit in STANDBY				
• Neutral - NORM				
• Neutral - OPEN				
Unit in ON, not pumping				
• Neutral - NORM				
• Neutral - OPEN				
Unit in ON, infusing @ 750 ml/min.				
▪ Neutral - NORM				
▪ Neutral - OPEN				

F. ELECTROMAGNETIC COMPATIBILITY

WARNING!

Medical Electrical Equipment needs special precautions regarding EMC and needs to be installed and put into service according to the Electromagnetic Compatibility [EMC] information provided in the accompanying documents.

WARNING!

Portable and Mobile RF Communications Equipment can affect Medical Electrical Equipment.

WARNING!

The equipment or system should not be used adjacent to or stacked with other equipment and that if adjacent or stacked use is necessary, the equipment or system should be observed to verify normal operation in the configuration in which it will be used.

NOTE: The EMC tables and other guidelines that are included in the Instruction Manual provide information to the customer or user that is essential in determining the suitability of the Equipment or System for the Electromagnetic Environment of use, and in managing the Electromagnetic Environment of use to permit the Equipment or System to perform its intended use without disturbing other Equipment and Systems or non-medical electrical equipment.

Table 201 Guidance and Manufacturer's Declaration – Emissions All Equipment and Systems		
The Belmont® Rapid Infuser, RI-2 is intended for use in the electromagnetic environment specified below. The customer or user of the Belmont® Rapid Infuser, RI-2 should assure that it is used in such an environment.		
Emissions Test	Compliance	Electromagnetic Enforcement – guidance
RF Emissions CISPR 11	Group 1, Class A	The Belmont® Rapid Infuser, RI-2 uses RF energy only for its internal function. Therefore, its RF emissions are very low and are not likely to cause any interference in nearby electronic equipment.
Harmonics IEC 61000-3-2	Complies or Not applicable	Complies
Flicker IEC 61000-3-3	Complies or Not applicable	Complies

Table 202 Guidance and Manufacturer's Declaration—Immunity All Equipment and Systems			
The Belmont® Rapid Infuser, RI-2 is intended for use in the electromagnetic environment specified below. The customer or user of the Belmont® Rapid Infuser, RI-2 should assure that it is used in such an environment.			
Immunity Test	IEC 60601 Test Level	Compliance Level	Electromagnetic Environment - Guidance
Electrostatic Discharge (ESD) IEC 61000-4-2	±6kV contact ±8kV air	±6kV contact ±8kV air	Floors should be wood, concrete or ceramic tile. If floors are synthetic, the relative humidity should be at least 30%.
Radiated RF IEC 61000-4-3	3 V/m	3 V/m	Radiated RF frequency is negligible at any single frequency
Electrical Fast Transient/burst IEC 61000-4-4	±2kV on AC Mains	±2kV on AC Mains	Mains power quality should be that of a typical commercial or hospital environment.
Surge IEC 61000-4-5	±1kV Differential ±2kV Common	±1kV Differential ±2kV Common	Mains power quality should be that of a typical commercial or hospital environment.
Conducted RF IEC 61000-4-6	3 Vrms from 150 kHz to 80 MHz	V1 = 3 Vrms	If interference occurs, it may be necessary to position the Belmont® Rapid Infuser, RI-2 further from sources of power frequency magnetic field.
Power Frequency 50/60Hz Magnetic Field IEC 61000-4-8	3A/m	3A/m	Power frequency magnetic fields should be that of a typical location in a typical commercial or hospital environment.
Voltage dips, short interruptions and voltage variations on power supply input lines IEC 61000-4-11	>95% Dip for 0.5 Cycle 60% Dip for 5 Cycles 30% Dip for 25 Cycles >95% Dip for 5 Seconds	>95% Dip for 0.5 Cycle 60% Dip for 5 Cycles 30% Dip for 25 Cycles >95% Dip for 5 Seconds	Mains power quality should be that of a typical commercial or hospital environment. If the user of the Belmont® Rapid Infuser, RI-2 requires continued operation during power mains interruptions, it is recommended that the Belmont® Rapid Infuser, RI-2 be powered from an uninterruptible power supply or battery.

G. FUSE

The fuse on the AC/DC supply marked F1 is rated as 1.25A, 250V, fast acting, 5x20mm.

H. CALL FOR SERVICE

1-855-397-4547 US/Canada
1-978-663-0212 Worldwide

Prior to returning any product, please obtain a Return Goods Authorization (RGA) number.

Before calling, please have the serial number of the unit. The serial number is located on the label above the power receptacle.

Technical Specifications of the Belmont RI-2

DIMENSION	
Size	13.5" x 12" x 7.5" (34.29cm x 30.48cm x 19.05cm)
Weight	28 lbs (12.7 Kg)

PORTABILITY	
Hand Carry	Handle on top of unit for easy transport
IV Pole Mount	IV pole mountable or free standing. I.V pole diameter range of pole mount: 1" - 1 1/4"

POWER	
AC	
Input Voltage	115-120 V ~ or 230 V ~
Fuse	1.25A, 250V, Fast Acting, 5x20mm
Operating Frequency	50/60 Hz
Maximum Power	1440 VA
Line Isolation	1500 V to ground
Earth Leakage Current	< 300 μ A (For Domestic unit) < 500 μ A (For 230 V ~ unit)
Electrical Compliance	EN 60601-1, CSA/C22.2 - No. 601.1-M90
Circuit Breaker	15Amp, 125VAC/250VAC, 50/60 Hz
Power Cord	U.S.: 3 conductors, 14 AWG type SJT Cord with Hospital grade plug Outside U.S.: 3 x 1.5 mm ² International Harmonized Cordage with Hospital grade plug
Battery Type	Rechargeable lead acid
Running Time	> 30 minutes at 50ml/min. without heat
Recharge Time	8 hours

ENVIRONMENTAL	
Operating Temperature	10°C to 32°C (50°F to 90°F)
Storage Temperature	-15°C to 40°C
Relative Humidity	10% to 90%
Pressure	49-103 kPa
Shock and Vibration	Meet MIL STD.810E method 514.4 (Basic Transportation)



OPERATING PARAMETERS	
Flow Rate	<p>10 - 750 ml/min, with a 1000 ml/min as an option, in 10 ml/min steps plus 2.5 and 5.0ml/min with fluids of viscosity 1 to 8 centipoise (Water and crystalloid fluids through packed red cells)</p> <p>Tolerance: ± 10% from 20 - 1000 ml/min ± 25% for 2.5, 5.0, 10 ml/min</p>
Output Temperature	<p>Set to 37.5°C for flow ≥ 60ml/min, to 39°C at 50ml/min or lower.</p> <p>Tolerance: 1°C for fluid temperature between 30°C to 40°C and 2°C outside this range</p>
Heating Capacity	Min. 1400 watts to fluid (20°C temperature rise at 1000 ml/min)
Line Pressure	0 - 300 mm Hg, via pressure transducer
Operating Modes	<ul style="list-style-type: none"> a) Load disposable set b) Prime system c) Prime patient line d) Infuse at operator controlled rate with warming e) Infuse fixed volume bolus with warming f) Stop system











OPERATING PANEL	
Control Panel and Display	Splash proof touch screen display
Display Area	Diagonal screen 5.7" (14.5 cm)
Status Display	Flow rate (ml/min) Total volume infused (ml) Line pressure (mm hg) Output infusate temperature (°C) Bolus volume (ml) Alarm messages
Functional Keys	Keys are displayed appropriate to the particular point in operation
Character Display	Graphical Alarm Messages - display where errors have occurred

SAFETY AND MONITORING	
Infusate Temperature	Via infra-red sensors at the input and output to the heat exchanger.
Line Pressure	A pressure transducer monitors the in line pressure. If the pressure reaches the threshold set by the user, the pump will slow down until pressure falls below the threshold. If the in-line pressure rises faster than 40 mm Hg/ml or exceeds 400 mm Hg, an alarm sounds, the "HIGH PRESSURE" message is displayed, the line to the patient is closed and pump comes to an immediate stop.
Air Detection	Two ultrasonic air detectors monitor air in the fluid path. The fluid detector is mounted closest the fluid bag. It sounds an alarm if there is no fluid entering the system. The other air detector checks for air in the fluid line before it enters the patient line. Out of Fluid criterion: Detect 0.8ml air in input line Air detection criterion: Detect 0.1ml air in fluid line
Valve wand	Provides flow path to patient, or recirculation fluid path within the system. The recirculation path is used to prime the system and eliminate air after an air detection alarm. The recirculation path is activated at all alarm conditions.

ALARM STATES and CONTROLS	ALARM MESSAGES
Operator Setting, User-correctable	MISSING DISPOSABLE DOOR OPEN FLUID OUT AIR DETECTION HIGH PRESSURE
System Status	LOW BATTERY
Heating Alarms	SYSTEM ERROR #101 & 102
Hardware Alarms	SYSTEM ERROR #201, 202, 203, 204, 205, 206, 207, 208, 209 & 210

DISPOSABLE SETS	
3 Spike Disposable Set REF: 903-00006	Filter Size: 250 micron
3.0 Liter Reservoir REF: 903-00018	Filter Size: 160 micron
4.4 Liter Reservoir REF: 902-00034	Filter Size: 250 micron

Classifications	
Type of Protection Against Electric Shock	Class I, or internally powered
Degree of Protection Against Electric Shock	CF defibrillator-proof
Degree of Protection Against Harmful Ingress of Water	IPX2
Method of Sterilization	Ethylene Oxide. Disposable delivered sterile, with pyrogen-free flow path, for single use only
Degree of Safety in Presence of Flammable Anaesthetics	Not suitable
Mode of Operation	Continuous
<p>Medical Equipment</p>   <p>UL 60601-1 CAN/CSA-C22.2 No. 601.1 ANSI/AAMI/ES60601-1 (2005) CAN/CSA-C22.2 No. 60601.1 (2008)</p>	<p>Medical – General Medical Equipment</p> <p>As to electrical shock, fire and mechanical hazards only in accordance with UL 60601-1, CAN/CSA-C22.2 No. 601.1, ANSI/AAMI/ES60601-1 (2005, 3rd ed.), CAN/CSA- C22.2 No. 60601-1 (2008).</p>
Medical Device Directive: Council Directive 93/42/EEC	Hardware: Class IIb
	Disposable Set: Class IIa

Symbols and Definitions	
Symbol	Description
	Compliance to Medical Device Directive 93/42/EEC and 2011/65/EU
	Alternating current
	Equipotentiality
	Standby
	ON
	Caution
 or 	Consult accompanying documents/refer to manual
	Defibrillator-proof type CF equipment
IPX2	Protected against dripping water
SN	Serial Number
	Manufactured by
	Authorized European Representative