



sigmaspectrum

# Operator's Manual

## 35700BAX & 35700ABB

Gen 2 Operating System

Pump Operating Software v6.05

For Use with MDL Editor v6.2.4

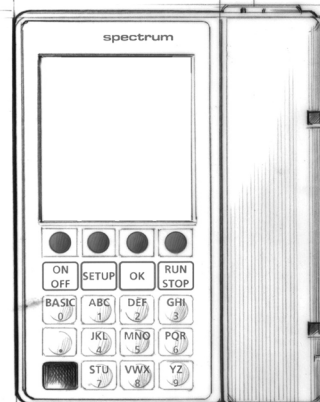

SIGMA, LLC  
711 Park Avenue  
Medina, New York 14103  
v 800 356 3454  
f 585 798 3909  
[www.sigmapumps.com](http://www.sigmapumps.com)



©2011 Copyright SIGMA, LLC

711 Park Avenue

Medina, New York 14103

v 800 356 3454

f 585 798 3909

[www.sigmapumps.com](http://www.sigmapumps.com)



# TABLE OF CONTENTS

<b>Introduction and Safety</b> .....	<b>1</b>
Intended Device Use .....	1
Related Documents .....	1
Regulatory Information .....	1
Contacting SIGMA Technical Support .....	1
Conventions .....	2
Summary of Warnings and Cautions .....	2
<b>System Components</b> .....	<b>10</b>
Spectrum Pump Illustrations .....	11
Hardware Labeling .....	12
<b>Battery Compatibility</b> .....	<b>13</b>
<b>Setting Up the Pump</b> .....	<b>14</b>
Unpack the Pump .....	14
AC Power Adaptor .....	15
Cleaning the Power Adaptor .....	15
Connecting the Power Adaptor .....	15
Removing the Power Adaptor .....	16
Charging the Battery .....	16
Configuring User Options .....	17
User Options .....	17
The User Options menu has three categories: .....	17
<b>Operational Overview</b> .....	<b>20</b>
Starting a New Infusion Using the Dose Error Reduction System (DERS) .....	23
Starting a New Infusion using the BASIC Mode .....	24
Secondary Infusions .....	24
<b>Preparing the Pump and IV Sets</b> .....	<b>25</b>
Loading an IV Set .....	26
Unloading an IV Set .....	27
Preparing the Pump for a Secondary Infusion .....	27
<b>Programming the Pump</b> .....	<b>28</b>
Infusion Programming Modes: .....	29
Keys Used to Program and Operate the Pump .....	30
Activating a Drug Library on a Pump with a Wireless Module .....	32

Programming the Pump Using the Dose Error Reduction System	33
Programming the Pump Using the BASIC Mode	37
Setting up a Secondary Infusion	40
Clearing the Secondary Mode While Returning to the Primary Infusion	45
Secondary Callback – Assigned to a Secondary Drug in the Drug Library	45
Programming a Loading Dose	48
Programming a Bolus	49
Multi-Step Programming	49
Cyclic TPN Mode	51
Titration	52
Delayed Run	55
Weight Confirmation	55
<b>Pump Operation</b>	<b>56</b>
Operating Tips	56
Placing the Pump in STANDBY (Hold)	57
Operating the Keypad Lock	58
<b>Alarms</b>	<b>59</b>
Silencing an Alarm	60
Clearing an Alarm	60
Alarm Messages	60
Preventing Nuisance Alarms	64
Managing Bolus before Occlusion (Downstream) Release	64
Battery Warning Levels	64
<b>Cleaning and Storage</b>	<b>67</b>
Compatible Cleaners	67
Cleaning the Pump	68
<b>Compatible IV Sets</b>	<b>69</b>
SIGMA Nitroglycerin/Lipid Sets	69
SIGMA Y-Type Blood Sets	69
Compatible Baxter IV Sets	70
Compatible Baxter IV Sets – WARNINGS	72
Compatible Hospira IV Sets	73
Compatible Hospira IV Sets – WARNINGS	75

<b>Accessories</b> .....	<b>77</b>
Tandem Carrier .....	77
Multi-Pole .....	78
AC Power Adaptor Protector .....	78
Double Rotating Pole Clamp Assembly .....	79
<b>APPENDIX A - Specifications</b> .....	<b>80</b>
Master Drug Library (MDL) Editor .....	80
Drug Library Transfer .....	80
Standard Gravity IV Sets .....	80
Standards .....	80
<b>APPENDIX B - Flow Rate Accuracy</b> .....	<b>86</b>
Effect of Fluid Container Height .....	86
Effect of Back Pressure .....	86
Flow Profile .....	86
<b>APPENDIX C - Bolus Accuracy</b> .....	<b>95</b>
<b>APPENDIX D - Downstream Occlusion</b> .....	<b>96</b>
Time to Occlusion .....	96
Bolus Volume .....	96
<b>APPENDIX E - Electromagnetic Compatibility</b> .....	<b>97</b>
Emissions .....	97
Immunity – ESD, transient/burst, voltage disparity, magnetic .....	98
Immunity – Conducted and Radiated .....	100
Immunity – Separation Distances .....	102
<b>APPENDIX F - Low / Very Low Battery Tutorial</b> .....	<b>103</b>
Low Battery Tutorial .....	103
Very Low Battery Tutorial .....	104
<b>APPENDIX G - Icons</b> .....	<b>105</b>
Power Icons .....	105
Wireless Icons .....	107
General Icons .....	108

**APPENDIX H- SPECTRUM DEFAULT SETTINGS ..... 109**  
    Factory Settings for Pump Software .....109  
    BASIC Configurations ..... 110



# INTRODUCTION AND SAFETY

## Intended Device Use

The Spectrum and Spectrum with Master Drug Library is intended to be used for the controlled administration of intravenous fluids. These fluids may include pharmaceutical drugs, blood, blood products, and mixtures of required patient therapy. The intended routes of administration consist of the following clinically acceptable routes: intravenous, arterial, subcutaneous, intrathecal, epidural or irrigation of fluid space. The Spectrum is intended to be used in conjunction with legally marketed intravenous administration sets and medications provided by the user.

The Spectrum and Spectrum with Master Drug Library are suitable for many user facility applications such as, but not limited to, hospitals, outpatient care areas, home care, and ambulatory care services.

The Spectrum and Spectrum with Master Drug Library are intended to reduce operator interaction through guided programming, thereby helping to reduce errors associated with complex device programming. Parameter programming requires trained health care professional confirmation of limits and drug therapy to physician's directive.

The SIGMA Spectrum and SIGMA Spectrum with Master Drug Library have not been tested or approved for use in motor vehicles or aircraft.

## Related Documents

The following documents also pertain to the SIGMA Spectrum with Gen 2 Operating System:

- Service Manual P/N 41019
- MDL User Manual P/N 41020

## Regulatory Information

Conforms to UL STD 60601-1

Certified to CAN/CSA STD C22.2 NO 601.1-M90

## Contacting SIGMA Technical Support

Contact SIGMA LLC for all service information at:

Telephone: 1-800-356-3454

E-mail: [techsupport@sigmapumps.com](mailto:techsupport@sigmapumps.com)

## Conventions



**WARNING:** Indicates a potentially hazardous situation which, if not avoided, could result in death or serious injury.

---

**CAUTION:** Indicates a potentially hazardous situation which, if not avoided, may result in minor or moderate personal injury or property damage. This word is used to also alert against unsafe practices.

---

## Summary of Warnings and Cautions



**WARNING:** Operation is Limited to Trained and Tested Operators

SIGMA Spectrum operation is strictly limited to trained operators whose competency in safe Spectrum operation and in safe IV therapy practices has been tested and proven. Pump owners have sole responsibility for operator training and testing even when SIGMA personnel assist in training processes.

---



**WARNING:** Confirm Safe Operation at Start and Thereafter

Only trained health care professionals can operate Spectrum Gen 2 Operating software. Confirm safe, accurate pump operation at start and periodically thereafter by:

- Ensuring that IV sets or container vents are properly functioning, that tubing clamps are in the proper positions, and that tubing is free from kinks or signs of collapse outside the pump.
- Observing the drip chamber to verify that there is no flow from your fluid container when the pump is stopped.
- Confirming the drip rate approximates the pump's flow rate during RUN operation.
- Confirming pump settings are as intended.
- Confirming correct: patient, route, dose rate, dose mode, time, and drug/concentration.
- With IV therapy, vital signs and IV access sites are monitored per facility's standard practice of care.
- The Spectrum Gen 2 Operating System is not intended to replace clinician patient observation.
- When using the pump periodic patient monitoring must be performed to ensure that the infusion is proceeding as intended.

- The pump was not designed nor is it intended to detect infiltrations or extravasations.

Never operate the Spectrum unless all of the above safe operations are being practiced.



**WARNING:**

Prevent Inaccuracy

The following can cause flow rate inaccuracies and must be avoided:

- Incompatible brand IV sets and compatible brand IV sets with unusually large or small diameters or unusually stiff materials.
- Operating temperatures outside of 60-90°F for Standard Battery and 60-80°F for Wireless Battery Module.
- Using IV sets longer than is recommended in the Specifications section of this manual.
- Using a dropped, damaged, dirty or wet pump.
- Pressurizing IV bags.
- Positioning IV containers more than 3 feet above or 1 foot below the pump.
- Non-vented IV sets with rigid non-vented containers, or vents on sets or burettes left in the closed position when they should be open.
- Using Microdrip or Minidrip chambers for flow rate settings greater than 200 mL/hr. Doing so may influence flow rate accuracy and cause nuisance air or upstream occlusion alarms.
- Exceeding 500 mL/hr flow rate settings when using sets with backcheck valves. Doing so may influence flow rate accuracy or cause nuisance upstream air or upstream occlusion alarms. Flow rates above 300mL/hr may cause fluid to be siphoned from the primary container during piggyback operation (see Secondary Infusion).



**WARNING:**

Upstream occlusions caused by improperly vented glass bottles or burettes may not be detected because of the very slow-building vacuums resulting from these situations.



**WARNING:**

Follow Epidural Precautions

Epidural administration of drugs other than those indicated for epidural use can result in serious patient injury.

- When administering epidural analgesics, use only catheters specifically labeled for epidural analgesia drug delivery.
- To help prevent accidental infusion of non-epidural drugs, DO NOT USE epidural administration sets that contain injection sites.
- Label the administration container and IV set “EPIDURAL USE ONLY”.
- Clearly identify infusion pumps used for epidural administration.
- Use KEYLOCK.



**WARNING:** Follow Neonatal and Pediatric Precautions

- Use 60 drop / 1mL IV sets.
- Configure the pump with appropriate flow rate, VTBI (Volume To Be Infused), patient weight and occlusion alarm limits (using CONFIGURATIONS/Options mode).
- Prior to connecting to patient, prime IV set, then close roller clamp, load IV set, open slide clamp and roller clamp (if equipped) to avoid possible bolus (.2 mL) that would result around a door opening/set loading event.
- If the pump door is opened with an IV set connected to a patient. Bolusing at door closing must be avoided. Before closing the door, clamp the set below the lower Y site. Connect a syringe to the lower Y site, close the door, open the slide clamp, collect a 0.085 mL bolus in the syringe and unclamp the set below the Y site.



**WARNING:** Do Not Allow Uncontrolled Gravity Flow

When loading a primed IV set, ensure, before pump manipulation, that the roller clamp below the pump is in the closed position. To open the pump door, the IV set's slide clamp must first be closed (thus providing "set-based anti-free flow" protection). Do not open the slide clamp when the door is open or during and after IV set unloading. This can cause dangerous, uncontrolled free flow to occur. During IV container changes, always close the set's roller clamp. When the set is in the pump and the door is closed, the slide clamp can safely be opened. If gravity flow is to be used, the pump door will be open or the set will be outside the pump. Verify gravity flow is maintained at the intended rate whenever the pump door is open and when the set is outside of the pump.



**WARNING:** A fluid bolus will occur (maximum of 0.1 mL) when the slide clamp is removed and the administration set is loaded.



**WARNING:** Disposal

To dispose of this device or the associated administration sets, adhere to local, state, federal and/or other governing regulations.



**WARNING:** Use the Specified Manufacturer's IV Set Type

This label is located on the top of the pump and indicates the specific type of IV tubing that the pump has been calibrated for. The use of other manufacturer's brands or type tubing could produce pump inaccuracies that could be unsafe for patients.

---



**WARNING:** Upstream Occlusion Alarm Suspension feature should not be used when delivering critical drugs where the risk of flow stoppage due to an undetected upstream occlusion outweighs that of flow interruption due to nuisance alarms where no upstream occlusion is present.



**WARNING:** Upstream Occlusion Alarm Suspension feature should not be used for drugs delivered in RIGID containers since the flow restriction caused by lack of proper container venting may be difficult to recognize when troubleshooting an alarm condition.



**WARNING:** Upstream Occlusion Alarm Suspension feature should only be used after the operator visually observes positive line flow.



**WARNING:** Baxter IV Sets.

- Minidrip sets should not be used for flow rate settings greater than 200 mL/hr. Doing so may influence flow rate accuracy and cause nuisance upstream air or upstream occlusion alarms.
- When using sets with backcheck valves flow rate settings should not exceed 500 mL/hr. Doing so may influence flow rate accuracy or cause nuisance upstream air or upstream occlusion alarms. Flow rates above 300 mL/hr may cause fluid to be siphoned from the primary container during piggyback operation.
- Failure to prime/remove all air bubbles from a backcheck valve in a primary set may cause the valve to malfunction, resulting in secondary fluid flow back up into the primary container.
- Partially occluded filters can cause nuisance upstream air, upstream occlusion or downstream alarms and influence flow rate accuracy.
- Burettes with closed vents, or shutoff valves will cause upstream occlusions that may not be detected by the infusion pump.
- Rigid unvented containers used with unvented sets or vented sets with vent closed, will cause upstream occlusions that may not be detected by the infusion pump.
- Ball Valve operation may not be detected as an alarm condition when using the SIGMA Spectrum Pump.
- Rigid polyethylene lined tubing, as is often used in nitroglycerine sets, may produce as much as 10 PSI downstream occlusion pressure above the lower limit of the SIGMA Spectrum Pump specification.
- Some Sets contain two or more slide clamps. Only the slide clamp on the pumping section or on the section with the main roller clamp should be used for pump operation and clamp detection. Other slide clamps associated with the set need to be observed and controlled by the user.

- Blood sets with both clamps closed above the blood filter will cause upstream occlusion conditions that may not be detected by the pump. See the Specification Section for Downstream Occlusion times and bolus release information.



**WARNING:** Hospira IV Sets.

- Microdrip chambers should not be used for flow rate settings greater than 200 mL/hr. Doing so may influence flow rate accuracy and cause nuisance air or upstream occlusion alarms.
  - When using sets with backcheck valves, flow rate settings should not exceed 500 mL/hr. Doing so may influence flow rate accuracy or cause nuisance upstream air or upstream occlusion alarms. Flow rates above 300 mL/hr may cause fluid to be siphoned from the primary container during piggyback operation (see Secondary Infusion).
  - Failure to prime/remove all air bubbles from a backcheck valve in a primary set may cause the valve to malfunction, resulting in secondary fluid flow back up into the primary container.
  - Partially occluded filters can cause nuisance upstream air, upstream occlusion or downstream alarms and influence flow rate accuracy.
  - Burettes with closed vents, or shutoff valves will cause upstream occlusions that may not be detected by the infusion pump.
  - Rigid unvented containers used with unvented sets or vented sets with vent closed, will cause upstream occlusions that may not be detected by the infusion pump.
  - Yellow Key Slide Clamp sets are only compatible with Spectrum software versions 4.02.06 or higher and are keyed for correct direction of flow.
  - Sets having a length that is greater than 48 inches from the exit of the pump to the patient connection end may have an increased downstream occlusion pressure, time to occlusion and bolus at occlusion release. For rates of less than 100 mL/hr, the pump should be set to the LOW downstream pressure setting.
  - Some IV sets contain two or more slide clamps. Only the slide clamp on the pumping section or on the section with the main roller clamp should be used for pumping operation and clamp detection. Other slide clamps associated with the set need to be observed and controlled by the user.
  - This set is configured with a roller clamp above the set slide clamp. When loading it into the Spectrum Pump ensure proper set orientation with slide clamp located above the pump.
  - Blood sets with both clamps closed above the blood filter will cause upstream occlusion conditions that may not be detected by the pump. See the Specification Section for Downstream Occlusion times and bolus release information.
-



**WARNING:** The Spectrum Pump is not designed to be MRI-compatible nor is it intended to be used in this manner. Strong magnetic fields (those beyond the level tested) may cause the device to operate improperly.

Do not expose the SIGMA Spectrum to strong magnetic fields such as is common with MRI equipment. Doing so may cause injury to the patient and/or damage to the equipment.

---

**CAUTION:** The Power Adaptor with Protector is compatible with the cleaners mentioned in this Operators manual. For the methods of cleaning and compatible cleaners that can be used on the AC Power Adaptor with Protector. See “Cleaning and Storage” on page 67.

---

**CAUTION:** Use Keypad Lock to Avoid Tampering

---

**CAUTION:** Close the clamp on the secondary line or remove the secondary container administration to prevent the secondary medication from flowing when the Primary mode is intended.

---

**CAUTION:** Use Stable IV Poles

Mount pumps on IV poles that securely hold the pump.

---

**CAUTION:** Service Personnel Must be Trained by SIGMA

Servicing Spectrum Pumps is restricted to qualified, SIGMA-trained, service personnel who employ SIGMA authorized parts and procedures. Use of other parts and servicing procedures is prohibited.

---

**CAUTION:** Perform Preventative Maintenance Annually

Pumps should be tested for proper performance annually and also whenever damage from drops, fluid intrusion and other causes is suspected. See SIGMA Spectrum Service Manual for complete information.

---

**CAUTION:** Do Not Improperly Clean Pumps

- During cleaning, do not allow fluid to seep inside pump (especially through front panel door latch holes or back case speaker holes) or severe damage may occur. Wipe on minimal amounts of cleaning fluids, never spray them. Use only SIGMA specified compatible cleaning fluids. Do not autoclave or ETO sterilize pumps.
  - Always wear gloves when cleaning a pump.
  - Alcohols are flammable and should not be used for Battery cleaning/disinfection.
  - Alcohols should only be used in well ventilated spaces.
-

- When cleaning the battery pack, care should be taken to prevent shorting of the pack's exposed terminals.

---

**CAUTION:** Be Cautious Near RF Sources

The Spectrum Pump meets the electromagnetic compatibility (EMC) requirements as specified in the International Electrotechnical Commission's (IEC) 60601-1-2 (2001-09) standard for emissions and immunity. It is good practice to keep the pump separated away from other equipment, such as hand-held transmitters, cellular phones and electrosurgical equipment that may generate strong radio frequency interference (RFI). Refer to the EMC Immunity Section, Separation Distance, in this manual for recommended minimum distance.

---

**CAUTION:** Confirm Audio Operation

When pressing the ON key and all other keys, confirm that an audio beep is heard. If sound cannot be heard, discontinue use of the pump and return to SIGMA for service.

---

**CAUTION:** Confirm Display Operation

Regularly observe the pump's display. Discontinue use of the pump and return to SIGMA for service if display abnormalities are observed.

---

**CAUTION:** Electric Shock Hazard

Refer servicing to qualified service personnel at your institution or return to SIGMA.

---

**CAUTION:** Accuracy

Refer to trumpet curves for flow rate accuracy as a function of short infusion durations. See "APPENDIX B - Flow Rate Accuracy" on page 86.

The upstream occlusion detector may not detect partially occluded tubing. Always check to ensure the IV set's clamp is not closed above the Spectrum Pump and respond appropriately to all primary and secondary check flow prompts.

Small bore catheters or needles may cause excessive back pressure at high flow rates. Size the catheters according to expected flow rate and fluid viscosity.

---

**CAUTION:** Follow Physicians Orders

- Federal (USA) law restricts this device to sale or use by, on the order of, or under the supervision of, a physician or other licensed health care practitioner.

---

**CAUTION:** Single Fault Conditions

A maximum bolus of 0.1 mL may be generated as a result of a single fault condition.



---

**CAUTION:** Only use the AC power adaptor specified for this equipment. Using other power adaptors may cause personal injury or damage to equipment.

---

**CAUTION:** This equipment is not suitable for use in the presence of a Flammable Anesthetic Mixture with Air or with Oxygen or Nitrous Oxide.

*NOTE:* This statement applies to oxygen enriched environments, such as oxygen tents. It is not meant to apply to patients on breathing tubes. Refer to IEC-60601-2-24.

---

## SYSTEM COMPONENTS

The SIGMA Spectrum with Gen 2 Operating Software is comprised of the following components:

Master Drug Library (MDL) Editor- A software tool intended to be used by pharmacists to list all medications that would be delivered via the Spectrum Pump, along with associated care areas and infusion parameters for each drug entry.

SIGMA Spectrum Infusion Pump - The pump and the interface for programming the pump.

- Gen 2 Error Prevention Systems:
  - Dose Error Reduction System (DERS)
  - Check Flow At Run
  - Secondary Error Prevention
  - Single Step Titration

Standard Gravity IV Sets - Compatible IV sets with slide clamp used for the door opening.

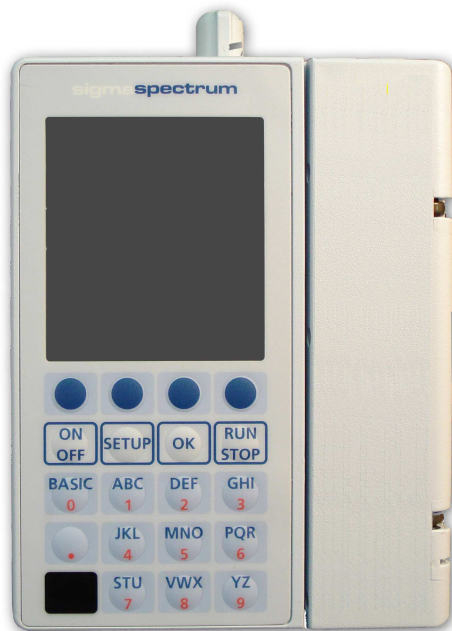

Figure 1. SIGMA Spectrum Pump

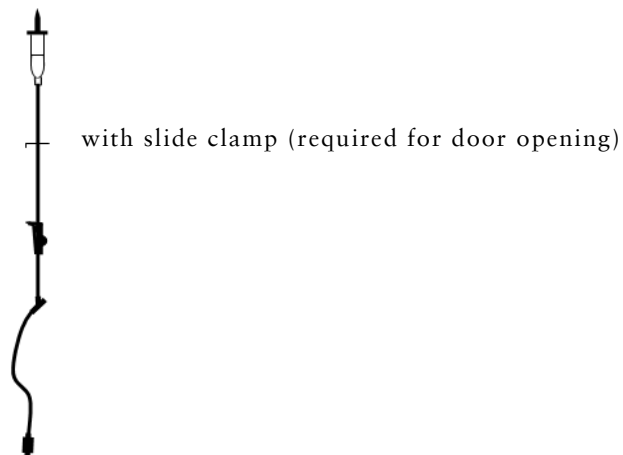

Figure 2. Standard gravity IV set

### Spectrum Pump Illustrations

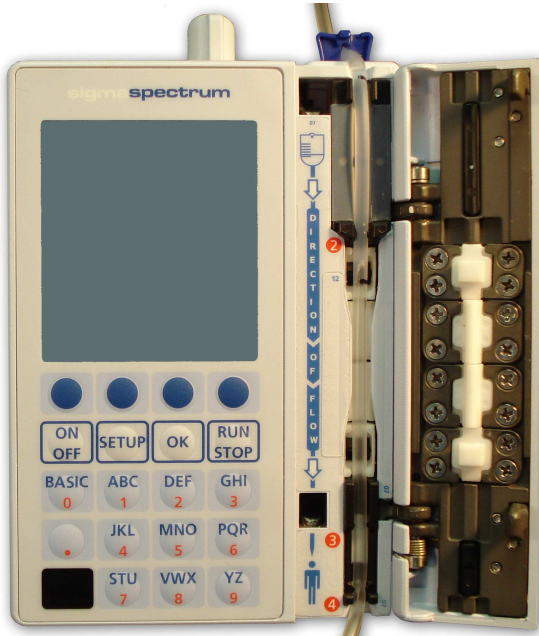

Figure 3. Front View - Door Open



Figure 4. Back View- With Standard Battery (P/N 35724)









Figure 5. Back View- With 802.11b Wireless Battery Module (P/N 35083)



Figure 6. Back View- With 802.11b/g Wireless Battery Module (P/N 35162)

## Hardware Labeling

The following is a description of the labels and symbols that appear on the Spectrum Pump

	<p>Attention, consult ACCOMPANYING DOCUMENTS (ISO 7010-W001)</p>
	<p>CLASS II EQUIPMENT (IEC 60417-5172)</p>
	<p>TYPE BF APPLIED PART (IEC 60417-5333)</p>
	<p>Direct current (IEC 60417-5031)</p>
	<p>Recyclable, dispose of properly (ISO 7000-1135)</p>
	<p>This is a representation of the Direction of Flow (not to scale). This label is located on the left side of the tubing channel. It is intended to assist the user in determining the direction of fluid flow from the medication container to the patient. The fluid direction is controlled by the pumping mechanism when the door is closed and the pump is in the infusion mode (running).</p>
	<p>Non-ionizing electromagnetic radiation (IEC 60417-5140)</p>

## BATTERY COMPATIBILITY

There are three battery types:

1. P/N 35724 - Standard Battery
2. P/N 35083 - 802.11b Wireless Battery Module
3. P/N 35162 - 802.11b/g Wireless Battery Module

The Standard Battery (P/N 35724) and 802.11b Wireless Battery Module (P/N 35083) are compatible with all SIGMA Spectrum Pumps.

The 802.11b/g Wireless Battery Module (P/N 35162) is only compatible with wireless G compatible pumps.

Wireless G compatible pumps are identified by the letter G preceding the serial number on the pump. (See Figure 7.) Pumps that do NOT have a letter G preceding the serial number are not compatible with the 802.11b/g Wireless Battery Module (P/N 35162). (See Figure 8.)



Figure 7. Serial Number for Pump Compatible with the 802.11b/g Wireless Battery Module (P/N 35162)



Figure 8. Serial Number for Pump NOT Compatible with the 802.11b/g Wireless Battery Module (P/N 35162)

## SETTING UP THE PUMP

### Unpack the Pump

The SIGMA Spectrum is packaged to provide protection during transportation and storage. When you unpack the pump, remove the Spectrum from the protective anti-static bag, remove the protecting foam end caps, and discard the desiccant package.

A battery tab isolates the battery voltage from the pump during transport and distribution. Remove the battery insulating tab prior to charging the pump's battery or operating the pump. To remove the battery tab, pull the tab away from the Battery Pack mounting cavity. (See Figure 9.)



Figure 9. Battery Tab

1. Save all packaging materials, except for the desiccant package, for reuse. This is advised in the event product repair or warranty replacement is necessary.
2. Fully charge the battery prior to use.
3. For battery charge specifications see “Battery Power and Capacity” section, beginning on page 82.

## AC Power Adaptor

---

**CAUTION:** Only use the power adaptor specified for this equipment. Using other power adaptors may cause personal injury or damage to equipment.

---

When plugged into a powered wall outlet, the AC Power Adaptor charges the pump's battery. The AC Power Adaptor uses a locking cord connection to prevent inadvertent disconnection.

**NOTE:** Avoid dropping AC Power Adaptors on the floor. Drops will cause them to malfunction. As with all electronic devices, drops should always be prevented.

## Cleaning the Power Adaptor

---

**CAUTION:** The Power Adaptor with Protector is compatible with the cleaners mentioned in this Operators manual. For the methods of cleaning and compatible cleaners that can be used on the AC Power Adaptor with Protector, see “Cleaning and Storage” section, beginning on page 67.

---

## Connecting the Power Adaptor

To engage the Power Adaptor:

1. Align the arrow on the Power Adaptor cord with the arrow on the connector identified as the external Power Adaptor connection (on the back of the SIGMA Spectrum Pump).
2. Insert the Power Adaptor module into the appropriate powered outlet receptacle.

The green LED on the Power Adaptor is on when the adaptor is plugged into a powered wall outlet. (See Figure 11.)

A plug symbol appears in the top left corner on the Spectrum Pump display, if the Power Adaptor is working properly when the pump is in operation. (See Figure 10.)



Figure 10. External Power Symbol



### Removing the Power Adaptor

*NOTE:* Improper removal may damage the AC Power Adaptor.

To remove the AC Power Adaptor, grasp the handle of the Protector and pull it back from the receptacle in a straight direction. (See Figure 11.)



■ A/C Power Adapter P/N 35714



■ A/C Power Adaptor P/N 35727

**Figure 11.** Pull the adaptor straight out

Do not pull the adaptor at an angle. This could bend the prongs. Do not pull the cord to unplug the adaptor from the receptacle. Improper twisting or pulling of the connector or cord may damage the power supply.

### Charging the Battery

When the SIGMA Spectrum is connected to the AC Power Adaptor and the adaptor is plugged into a powered outlet receptacle, the pump's Standard Battery Pack or Wireless Battery Module will be charged to full capacity. It is not necessary to turn the pump on.

Refer to "APPENDIX G - Icons" section, beginning on page 105 for a listing of the symbols used and their description.



## Configuring User Options

The Spectrum Pump has two sets of configuration options:

- User options
- Biomed options



**WARNING:** Operation is Limited to Trained and Tested Operators

SIGMA Spectrum operation is strictly limited to trained operators whose competency in safe Spectrum operation and in safe IV therapy practices has been tested and proven. Pump owners have sole responsibility for operator training and testing even when SIGMA personnel assist in training processes.

---

**NOTE:** For a description of the Biomed options, refer to the SIGMA Spectrum Service Manual.

### User Options

To access the User Options menu:

From the Care Area selection screen:

1. Press the **OPTIONS** soft key.
2. Select User Options from the menu and press **OK**.

From the RUN or STOPPED screen:

1. Press the **OPTIONS** soft key.

### The User Options menu has three categories:

- Alarm Settings
- Display Settings
- View Information

#### 1. Alarm Settings

- **Audio** – Speaker actuated audio alarm.
- **Audio Volume** – The audio volume of the pump has three levels; **LOW**, **MEDIUM**, and **HIGH**.
  - Audio Volume may be preset in the Master Drug Library Editor. The default setting is “Use Pump Setting”. “Use Pump Setting” is adjustable at the pump.
- **Audio Tone** – set the type of alarm tone that sounds: **Short** or **Long**.
- **Standby (hr:min)** – Set the length of time to keep the pump in Standby (or Hold) after setup of the infusion has completed. Settings are from 00:01 to 99:59 (hr:min). Setting the value to 00:00, or Infinite, results in an infinite Hold period.
- **Near-Empty alert** – When enabled, a Near-Empty alert is displayed when 30 minutes or less of infusion remains. If the initially programmed infusion is less than 30 minutes, the alert shall not be generated regardless of the setting.

- Near-Empty alert has three settable options in the Master Drug Library Editor, ON, OFF, or “Use Pump Setting”. The default setting is “Use Pump Setting”. “Use Pump Setting” is adjustable at the pump
- **Downstream Pressure Limit** – The Downstream Pressure limit has three levels: LOW (6 psi  $\pm$ 4 psi), MEDIUM (13 psi  $\pm$ 6 psi), and HIGH (19 psi  $\pm$ 9 psi).
  - The default Pressure Limit may be preset for a Care Area in the Master Drug Library Editor. The default setting is “Use Pump Setting”. “Use Pump Setting” is adjustable at the pump.

**NOTE:** This icon shall be displayed next to any configuration item in the options menu (User or Biomed) whose setting has been assigned in the Master Drug Library Editor to the currently selected drug.



## 2. Display Settings

- **Run Screen Options** – Each of the items in this list may be turned ON or OFF. If enabled, they are included in the alternating screens that are displayed while the pump is running.
  - Audio level indicator – shows L, M, or H (as selected in Audio Volume)
  - Rate mL/hr – shows the mL/hr infusion rate of the current delivery
  - Dose rate – shows the dose rate of the current delivery
  - mL VTBI – shows the remaining Volume To Be Infused, in mL
  - Time (hr:min) – shows the time remaining in the current infusion, in hr:min format
- **Display Adjust**
  - Backlight Level – The display backlight level may be adjusted from 1 to 10 (with 10 being the highest) or turned OFF. The backlight consumes approximately 400 mW when set to maximum brightness; therefore, battery life is maximized when the backlight is set to OFF.

## 3. View Information

- **Pump Information** – The pump information screen has the following read-only information that either the user (clinician) or Bio-Medical Engineer may find useful.
  - SW Version
  - Serial number – The serial number assigned by SIGMA for tracking and device history.
  - Tube type – the name of the IV tube set manufacturer that the device is calibrated for use with.
  - Wireless Module
- From the Pump information screen, press the **sw info** soft key to display the Software Version screen, which show the versions of the individual software components that are installed.
  - SW Version
  - Sharp
  - PIC

- CPLD
- SmartBatt Charger build
- Network Module
- **Library Information** – The library information screen identifies the name of the Active Drug Library in pump memory as well as the Name, Date Modified, Version Number, Format Indicators, Drugs, Care Areas, Advisories.
- **Show Clinical Advisory** – If the current infusion has a clinical advisory associated with it, selecting this option will display the advisory. If the current infusion does not have a clinical advisory associated with it, this option is not selectable and appears in grey text in the display.
- **Infusion Information** – The infusion information screen identifies the infusion-specific primary and secondary bag parameters that are not otherwise displayed on the setup screen. The information includes the following information for each bag (if programmed): audio level, near empty alert status (primary only), pressure setting, KVO rate (primary only), and primary siphoning alert or secondary complete alert status (secondary only).
- **History Log** – Selecting this option provides access to the event log. Available options for viewing the log are listed below.
  - NOTE:* Access to this option is provided only when the pump is not running (delivering). If the pump is running, this option is not selectable and appears in grey text in the display.
- **View History Log** – select this option to view the entire history log on the pump screen.
- **View System Error Log** – select this option to view only the system errors recorded in the history log.
- **View Drug Error Log** – select this option to view only the events associated with programming an infusion; including any drug limits that may have been exceeded during setup.
- **Dump History Log** – select this option to send the entire history log out of the pump via the IrDA port (refer to the Logging section of the SIGMA Spectrum Service Manual, (P/N 41019).

## OPERATIONAL OVERVIEW

The following sections provide a high-level overview of how to setup, program, and operate the Spectrum Pump. For detailed instructions, refer to these sections:

- “Preparing the Pump and IV Sets” section, beginning on page 25
- “Programming the Pump” section, beginning on page 28
- “Weight Confirmation” section, beginning on page 55
- “Alarms” section, beginning on page 59



**WARNING:** Confirm Safe Operation at Start and Thereafter

Only trained health care professionals can operate Spectrum Gen 2 Operating software. Confirm safe, accurate pump operation at start and periodically thereafter by:

- Ensuring that IV sets or container vents are properly functioning, that tubing clamps are in the proper positions, and that tubing is free from kinks or signs of collapse outside the pump.
- Observing the drip chamber to verify that there is no flow from your fluid container when the pump is stopped.
- Confirming the drip rate approximates the pump’s flow rate during RUN operation.
- Confirming pump settings are as intended.
- Confirming correct: patient, route, dose rate, dose mode, time, and drug/concentration.
- With IV therapy, vital signs and IV access sites are monitored per facility’s standard practice of care.
- The Spectrum Gen 2 Operating System is not intended to replace clinician patient observation.
- When using the pump periodic patient monitoring must be performed to ensure that the infusion is proceeding as intended.
- The pump was not designed nor is it intended to detect infiltrations or extravasations.

Never operate the Spectrum unless all of the above safe operations are being practiced.

---



**WARNING:** Prevent Inaccuracy

The following can cause flow rate inaccuracies and must be avoided:

- Incompatible brand IV sets and compatible brand IV sets with unusually large or small diameters or unusually stiff materials.
- Operating temperatures outside of 60-90°F for Standard Battery and 60-80°F for Wireless Battery Module.
- Using IV sets longer than is recommended in the Specifications section of this manual.
- Using a dropped, damaged, dirty or wet pump.
- Pressurizing IV bags.
- Positioning IV containers more than 3 feet above or 1 foot below the pump.
- Non-vented IV sets with rigid non-vented containers, or vents on sets or burettes left in the closed position.
- Using Microdrip or Minidrip chambers for flow rate settings greater than 200 mL/hr. Doing so may influence flow rate accuracy and cause nuisance air or upstream occlusion alarms.
- Exceeding 500 mL/hr flow rate settings when using sets with backcheck valves. Doing so may influence flow rate accuracy or cause nuisance upstream air or upstream occlusion alarms. Flow rates above 300mL/hr may cause fluid to be siphoned from the primary container during piggyback operation (see Secondary Infusion).



**WARNING:** Follow Epidural Precautions

Epidural administration of drugs other than those indicated for epidural use can result in serious patient injury.

- When administering epidural analgesics, use only catheters specifically labeled for epidural analgesia drug delivery.
- To help prevent accidental infusion of non-epidural drugs, DO NOT USE epidural administration sets that contain injection sites.
- Label the administration container and IV set “EPIDURAL USE ONLY”.
- Clearly identify infusion pumps used for epidural administration.
- Use KEYLOCK.



**WARNING:** Follow Neonatal and Pediatric Precautions

- Use 60 drop / 1mL IV sets.
- Configure the pump with appropriate flow rate, VTBI (Volume To Be Infused), patient weight and occlusion alarm limits (using CONFIGURATIONS/Options mode).
- Prior to connecting to patient, prime IV set, then close roller clamp, load IV set, open slide clamp and roller clamp (if equipped) to avoid

possible bolus (.2 mL) that would result around a door opening/set loading event.

If the pump door is opened with an IV set connected to a patient. Bolusing at door closing must be avoided. Before closing the door, clamp the set below the lower Y site. Connect a syringe to the lower Y site, close the door, open the slide clamp, collect a 0.085 mL bolus in the syringe and unclamp the set below the Y site.

---

**CAUTION:** Confirm Audio Operation

When pressing the ON key and all other keys, confirm that an audio beep is heard. If sound cannot be heard, discontinue use of the pump and return to SIGMA for service.

---

**CAUTION:** Perform Preventative Maintenance Annually

Pumps should be tested for proper performance annually and also whenever damage from drops, fluid intrusion and other causes is suspected. See SIGMA Spectrum Service Manual for complete information.

---

**CAUTION:** Follow Physicians Orders

Federal (USA) law restricts this device to sale or use by, on the order of, or under the supervision of, a physician or other licensed health care practitioner.

---

**CAUTION:** Accuracy

Refer to trumpet curves for flow rate accuracy as a function of short infusion durations. See "APPENDIX B - Flow Rate Accuracy", beginning on page 86.

The upstream occlusion detector may not detect partially occluded tubing. Always check to ensure the IV set's clamp is not closed above the Spectrum Pump and respond appropriately to all primary and secondary check flow prompts.

Small bore catheters or needles may cause excessive back pressure at high flow rates. Size the catheters according to expected flow rate and fluid viscosity.

---

**CAUTION:** Single Fault Conditions

A bolus of approximately 0.1 mL may be generated as a result of a single fault condition.

---

**CAUTION:** This equipment is not suitable for use in the presence of a Flammable Anesthetic Mixture with Air or with Oxygen or Nitrous Oxide.

**NOTE:** This statement applies to oxygen enriched environments, such as oxygen tents. It is not meant to apply to patients on breathing tubes. Refer to IEC-60601-2-24.

## Starting a New Infusion Using the Dose Error Reduction System (DERS)

1. Press the ON/OFF button to turn the pump on.
2. If the previous setup needs to be erased, press YES soft key when prompted “New Patient?”.

**NOTE:** ‘New Patient?’ Prompt – When the pump is turned on and programmed infusion data exists in memory, a screen is displayed asking the operator if the intended use for the pump is for a New Patient. Answering YES to this prompt clears the existing infusion data, answering NO retains the data and allows the operator to resume the infusion.(See Figure 12.)



Figure 12. New Patient Screen

3. Load the primed IV set.
4. Select your Care Area.
5. Select drug or fluid. (Type first 2 letters of drug name.)
6. Select and confirm a Concentration if more than one is displayed.
7. Select Delivery Bag (if required).
8. Enter and press OK to confirm all required values on the Setup Screen.
9. Confirm that all clamps and vents are in the proper position.
10. Press RUN/STOP to start the infusion.
11. Check and confirm proper flow.

## Starting a New Infusion using the BASIC Mode

### (For use only when drug is not in the Drug Library)

1. Press the **ON/OFF** button to turn the pump on.
2. If the previous setup needs to be erased, press **YES** soft key when prompted “New Patient?”, (see “New Patient” prompt above).
3. Load the primed IV set.
4. Select Care Area.
5. Select drug or fluid. (Enter “B” “A” prompts to BASIC Selection)
6. Select Delivery Bag.
7. Select a Dose Mode (default is mL/hr).
8. Enter and press **OK** to confirm all required values on the Setup Screen.
9. Confirm that all clamps and vents are in the proper position.
10. Press **RUN/STOP** to start the infusion.
11. Check and confirm proper flow.

## Secondary Infusions

1. Stop the pump if it is running.
2. Lower the primary bag at least 20" below the secondary bag.
3. Open secondary roller clamp.
4. Press the **REVIEW/PROGRAM** soft key.
5. Press the **PROGRAM SECONDARY** soft key.
6. Select drug or fluid for the secondary infusion, (type first 2 letters of drug name).
7. Select and confirm Concentration if more than one is displayed.
8. Press **OK** to select/confirm the secondary delivery bag.
9. Enter and press **OK** to confirm all required values on the setup screen.
10. Confirm that all clamps and vents are in the proper position.
11. Press **RUN/STOP** to begin secondary infusion.
12. Check the flow and confirm drops are falling in secondary drip chamber and no drops falling in the primary drip chamber.



## PREPARING THE PUMP AND IV SETS



**WARNING:** Use the Specified Manufacturer's IV Set Type

This label is located on the top of the pump and indicates the specific type of IV tubing that the pump has been calibrated for. The use of other manufacturer's brands or type tubing could produce pump inaccuracies that could be unsafe for patients.

---

**WARNING:** The following can cause flow rate inaccuracies and must be avoided:

Non-vented IV sets with rigid non-vented containers, or vents on sets or burettes left in the closed position when they should be open.

---

1. Mount the pump on an IV pole.
2. Plug the pump's AC Adapter into a powered outlet receptacle, if available.

**NOTE:** It is recommended that the Spectrum Pump's AC Adapter be plugged into a powered outlet receptacle whenever possible.

3. Select a compatible IV set. See "Compatible IV Sets", beginning on page 69.

Select only IV sets made by the manufacturer listed on top of the pump. IV sets must be of standard stiffness and diameter. Performance can not be achieved using stiff, large, or small diameter tubing. Contact SIGMA for compatible standard IV set lists and for special SIGMA blood, nitroglycerin and lipid sets.

**NOTE:** Pumped-on tubing should not be re-loaded into the pumping channel (to avoid nuisance alarms and to maintain flow rate accuracy).

4. Prepare IV fluid containers and prime IV sets:
  - Fill drip chambers approximately halfway.
  - Use standard gravity IV set priming technique to purge air from sets and all Y injection sites.
  - Close the roller clamp 12" below the upper Y injection site.
  - Allowing IV solutions to warm to room temperature before use will reduce nuisance air-in-line alarms.

## Loading an IV Set



**WARNING:** Do Not Allow Uncontrolled Gravity Flow

When loading a primed IV set, ensure, before pump manipulation, that the roller clamp below the pump is in the closed position. To open the pump door, the IV set's slide clamp must first be closed (thus providing "set-based anti-free flow" protection). Do not open the slide clamp when the door is open or during and after IV set unloading. This can cause dangerous, uncontrolled free flow to occur. During IV container changes, always close the set's roller clamp. When the set is in the pump and the door is closed, the slide clamp can safely be opened. If gravity flow is to be used, the pump door will be open or the set will be outside the pump. Verify gravity flow is maintained at the intended rate whenever the pump door is open and when the set is outside of the pump.



**WARNING:** When the set's slide clamp is removed from the pump's keyhole, a fluid bolus will occur (maximum of 0.1 mL) in the IV set if the administration set is loaded in the pump .

**CAUTION:** Accuracy

Refer to trumpet curves for flow rate accuracy as a function of short infusion durations. See "APPENDIX B - Flow Rate Accuracy" , beginning on page 86.

The upstream occlusion detector may not detect partially occluded tubing. Always check to ensure the IV set's clamp is not closed above the Spectrum Pump and respond appropriately to all primary and secondary check flow prompts.

Small bore catheters or needles may cause excessive back pressure at high flow rates. Size the catheters according to expected flow rate and fluid viscosity.

1. Power on the pump.
2. Position the slide clamp approximately 18" below the drip chamber and/or approximately 6" to 8" below the upper Y injection site.
3. Position the roller clamp on the IV tubing comfortably below the pump.
4. Insert the slide clamp into the keyhole (loading point #1) and press down until the door opens.
5. Observe the Direction of Flow diagram, left of the pumping mechanism with door opened.
6. Load the primed IV set tubing into the tubing channel:
  - Load the tubing from the top to bottom of the tubing channel.
  - Make sure the tubing is taut.
  - Push the tubing into loading point #2 and then loading points #3 and #4.

The tubing is properly loaded when the screen displays three green bars and check marks.

7. Confirm no drops are falling in the drip chamber.
8. Close the door by pressing the upper and lower corners near the door hooks.
9. Open the slide clamp by pulling it straight up and out of the keyhole, while holding the tubing around it down to provide strain relief.
10. Open the roller clamp and confirm no flow.
11. Confirm proper vent position, if applicable.

### Unloading an IV Set

1. Close the roller clamp.
2. Push the slide clamp into the keyhole until the door opens.
3. Pull the tubing out from the bottom of the pump towards the top.

*NOTE:* Be sure to prevent free flow whenever the pump door is open and when the set is out of the pump. This is accomplished by having the set's slide clamp or roller clamp fully closed or by partially opening the roller clamp to achieve gravity flow.

*NOTE:* When changing IV sets or containers always keep the roller clamp fully closed (except when following standard gravity set priming procedures).

### Preparing the Pump for a Secondary Infusion

If the infusion is to include both a primary and secondary bag and IV set, set up the bags and IV using the following instructions:

1. Prepare primary and secondary bags and IV sets.
2. Use a primary set with an upper Y injection site and backcheck valve.  
*NOTE:* Failure to prime/remove all air bubbles from backcheck valves in primary sets may cause the valve to malfunction, resulting in secondary fluid flow back up into the primary container.
3. Connect the secondary set to the primary set's upper Y injection site.
4. Using a drop hook, lower the primary bag approximately 20" below the secondary bag to provide the secondary bag with a gravity advantage. This causes the primary set's back-check valve to close, which allows secondary flow.
5. Confirm proper vent position, if applicable.

## PROGRAMMING THE PUMP

Gen 2 Error Prevention consists of four error prevention systems:

1. Dose Error Reduction System (DERS)
2. Check Flow At Run (doesn't apply to Anesthesia and OR Care Areas)
  - The screen (See Figure 13.) prompts the clinician at the start of the infusion to ensure that there are no closed clamps or kinks in the tubing that might prevent flow.
3. Secondary Error Prevention (doesn't apply to Anesthesia and OR Care Areas)
  - During secondary setup a popup (See Figure 14.) prompts the clinician to verify the secondary VTBI (Volume To Be Infused) equals the secondary bag volume.
  - The screen (See Figure 15.) prompts the clinician to verify drops are falling in the secondary drip chamber and not in the primary.

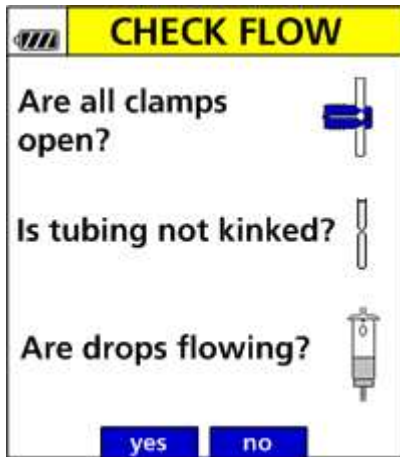

Figure 13. Check Flow at Run

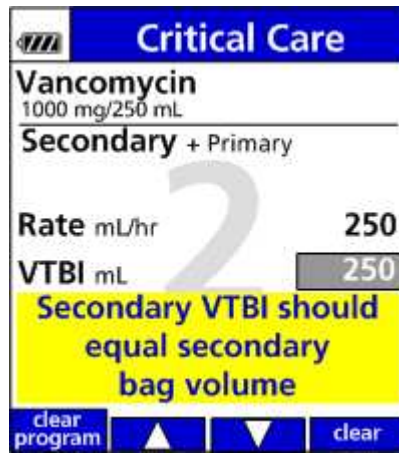

Figure 14. Secondary Bag Volume Confirmation

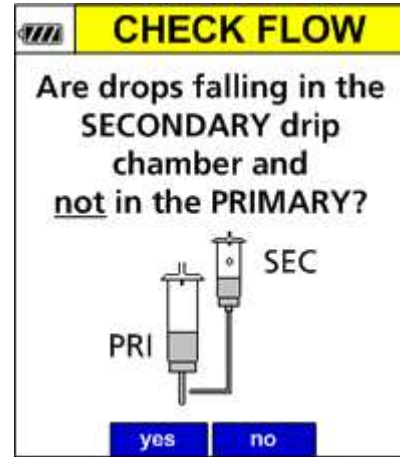

Figure 15. Secondary Check Flow

4. Single Step Titration (set at 500% in Anesthesia and OR Care Areas)
  - Each facility's Drug Library can be programmed with limits for the percent rate change that is considered safe for each single titration step.
  - A rate advisory (See Figure 16.) will alert the clinician if the dose or mL/hr rate has been programmed to exceed the facility's pre-configured limit.

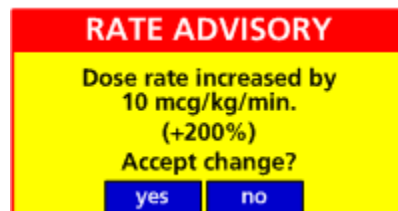

Figure 16. Single Step Titration Rate Alert

The SIGMA Spectrum Pump provides two main options for controlling infusions:

1. **Dose Error Reduction System (DERS)** - This system uses predetermined dosing information stored in the pump's Drug Library using the Master Drug Library Editor to control the dose, rate, volume, time and other infusion parameters for specific drugs. This system protects against programming errors that could cause Adverse Drug Events.
2. **BASIC Mode** - Drug library limits (DERS) do not exist when using BASIC mode. BASIC mode allows you to manually specify a dose mode, rate, volume, time, or other parameters for the infusion. BASIC mode does possess Gen 2 systems; Check Flow at Run, Secondary Error Prevention, and Single Step Titration.

### Infusion Programming Modes:

The following infusion programming modes are available with the Spectrum Pump using this operating software:

1. **Continuous Infusion** - IV drug or fluid therapy prescribed as a continuous dose rate. The IV therapy continues to infuse until no longer required and is often titrated to achieve optimal physiologic response.
  - Primary Mode
  - Secondary Mode
  - Multistep Mode
2. **Cyclic Mode** - IV drug or fluid therapy that requires a volume rate (mL/hr) ramp up to a main (mL/hr) rate for a prescribed period of time and then tapers the rate down until total infusion time has completed.

## Keys Used to Program and Operate the Pump

Hard Keys	Description
BASIC	BASIC is an infusion mode not utilizing DERS. This key directs user to BASIC instructions.
ALPHANUMERICAL	Programming screens enable numbers and drug selection screen enable letters. Press alphanumeric keys once, twice, or three times to select corresponding letters or numbers.
OK	Press to confirm entries and advance cursors.
ON/OFF	Press to turn the pump on or off.
RUN/STOP	Press to start or stop the infusion.
SETUP	Press to access drug selection screen.
<b>Soft Keys:</b> The top row of keys on the keypad are non-labeled keys with various functions depending on what is displayed above them.	<b>Description</b>
ARROWS	Press to advance cursors and/or select alternate choices.
BACK	Press to go back to the previous screen.
BOLUS	Press to access the Bolus setup.
CLEAR	Press to erase the highlighted entry.
CLEAR PROGRAM	Press to selectively clear primary mode, secondary mode, or both.
CLR STEP	Press to clear one step of Multi-Step Programming Mode.
EDIT	Press to change the flush volume on the flush setup screen
HOLD	Press to place the pump in standby mode.

<p><b>Soft Keys:</b> The top row of keys on the keypad are non-labeled keys with various functions depending on what is displayed above them.</p>	<p><b>Description</b></p>
<p><b>MULTI-STEP</b></p>	<p>Press to access the Multi-Step Programming Mode.</p>
<p><b>OPTIONS</b></p>	<p>Press to select additional pump features related to alarm settings, display settings, or information view.</p>
<p><b>PROGRAM SECONDARY</b></p>	<p>Press to set up a secondary infusion.</p>
<p><b>RESET</b></p>	<p>Press to restart the multi-step and cyclic TPN programs to the beginning of the program.</p>
<p><b>REVIEW</b></p>	<p>Press to view the setup screen without stopping the pump.</p>
<p><b>REVIEW PRIMARY/REVIEW SECONDARY</b></p>	<p>Press to view values in the setup screen.</p>
<p><b>REVIEW PROGRAM</b></p>	<p>Press to display the setup screen when pump is stopped.</p>
<p><b>SILENCE</b></p>	<p>Press to quiet the audio alarm for 2 minutes. Additionally, any key can be pressed for silence.</p>
<p><b>TAPER DOWN</b></p>	<p>Press to enable a cyclic TPN program to taper down automatically.</p>
<p><b>TITRATE</b></p>	<p>Press to change the flow rate and VTBI (volume to be infused) without stopping the pump.</p>

## Activating a Drug Library on a Pump with a Wireless Module

Activating a Drug Library is the process of replacing the current Drug Library or deploying a new Drug Library. The pump will receive a new Drug Library any time the pump is on, and at the drug library check interval specified in the Drug Library.

When a new Drug Library is received, it is placed in a “queued” position in the pump. While the new Drug Library is queued the current Drug Library remains the active Drug Library. When all infusions are cleared and the pump is returned to the Care Area screen the queued Drug Library is automatically made active.

While a Drug Library is queued a  icon will appear in the upper right hand corner of the pump screen.

To see, or activate, the new queued library that is available from the run screen:

1. Press the **OPTIONS** soft key.
2. Use the arrow buttons to select **VIEW INFORMATION** and press **OK**.

The Library Information screen displays the current active Drug Library information and the queued (new) drug library that is ready to be activated. (See Figure 17.)

3. Press the **EXIT** soft key to return to the run screen.
4. Stop the pump and clear the infusion program to make the queued Drug Library active. (See Figure 18.)

**NOTE:** Once a Drug Library is queued, the user cannot prevent the queued library from being activated.



Figure 17. Library Information



Figure 18. Library Update



## Programming the Pump Using the Dose Error Reduction System

1. Press the ON/OFF key to turn the pump on.
2. Use the arrow keys to select the Care Area (nursing area) and press OK. (See Figure 19.)

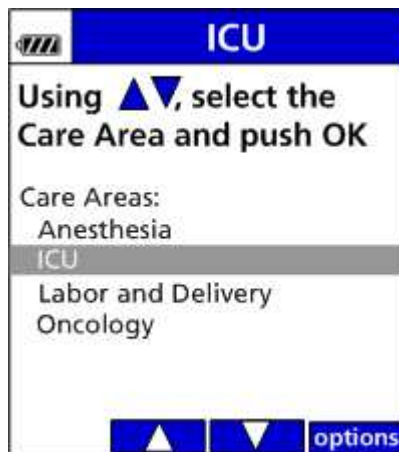

Figure 19. Select Care Area

3. Select the drug from the Drug Library:
  - Using the keypad, type the drug's first two letters and press OK. All drugs beginning with those two letters will appear. (See Figure 20.)

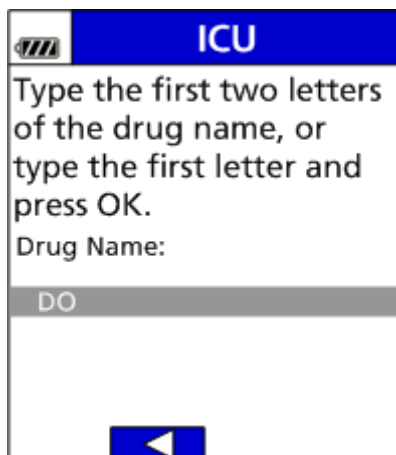

Figure 20. Type Drug's First Two Letters

**NOTE:** "D" is obtained by pressing the 2 key one time and the "O" is obtained by pressing the 5 key three times (similar to phone texting).

- Use the arrow keys to cursor to the desired drug and press OK.(See Figure 21.)

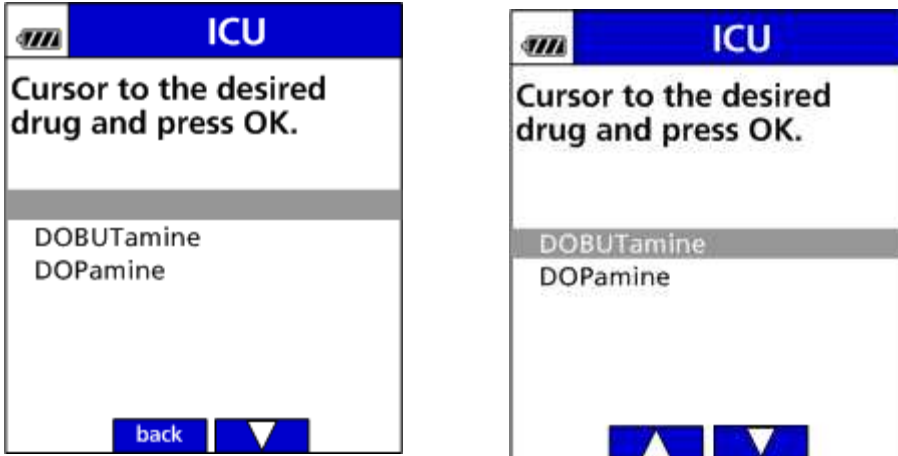

Figure 21. Select Drug Screen

4. Cursor to the correct drug concentration (if more than one is offered) and press OK.(See Figure 22.)

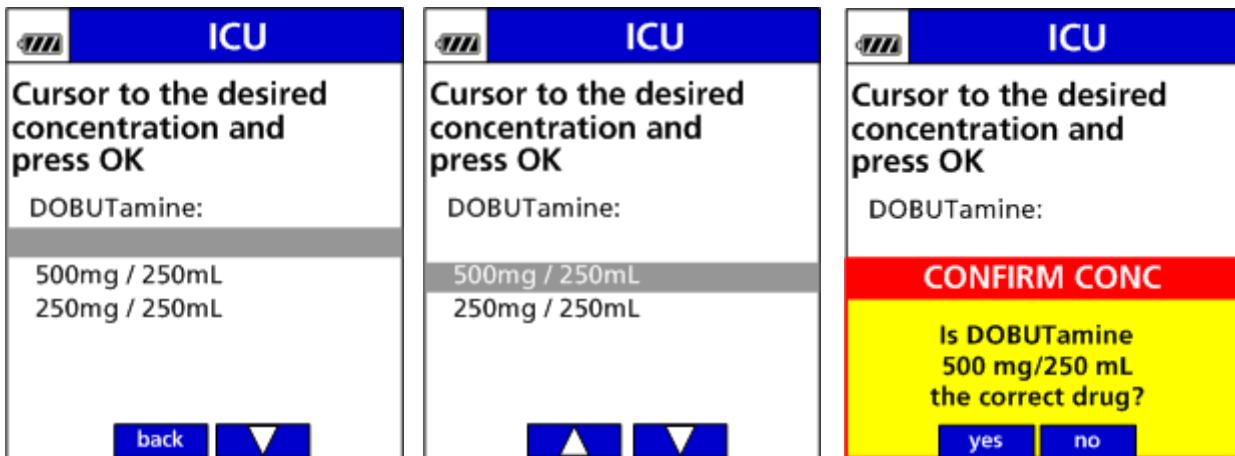

Figure 22. Select Concentration Screen

Once a concentration is selected, a dialog box appears prompting confirmation of the selected drug concentration. Press **YES** to continue or **NO** to reselect. Note that the confirmation dialog box appears only when you select from a list of concentrations or if you are entering a concentration manually to a drug that has been assigned a “variable” concentration in the Drug Library.

- Use the arrow buttons to indicate whether you are setting up the primary or secondary bag and press OK. (See Figure 23.)



Figure 23. Bag Selection Screen

**NOTE:** The bag selection prompt does not appear if the selected drug has been specifically assigned in the Drug Library as:

- Primary no secondary
- Secondary only
- Primary only multi-step

- Enter all required values on the Setup Screen. (See Figure 24.)
- Review the parameters of the drug as displayed on the programmed Setup Screen. (See Figure 25.)



Figure 24. Primary Setup Screen



Figure 25. Programmed Setup Screen

**NOTE:** If Weight Confirmation is enabled (set up in the Drug Library) the pump will require that the patient weight parameter is re-entered into the pump. Both entered values must match to confirm patient weight.

**NOTE:** You will receive a dialog box if you exceed the dose rate limits defined in the Drug Library for the drug.

- **Soft dose rate or mL/hr limits** may be exceeded by pressing **OK** followed by pressing the **YES** soft key to accept or the **NO** soft key to decline the dose rate displayed in the dialog box.
  - **Hard dose or mL/hr limits** cannot be exceeded. Re-enter rates within hard limits.
  - **Single Step Titration (Rate advisory)** – dose or mL/hr rate entered is increased or decreased by a % (set in the Drug Library) above or below the current rate.
    - Press **YES** to accept or **NO** to decline the change displayed in the dialog box.
    - In **BASIC** mode the rate advisory is set for an increase (+) of 101% and a decrease (-) of 51% and cannot be changed.
    - The rate advisory is set for an increase (+) of 500% and a decrease of (-) 99% if the selected Care Area name contains “Anesthesia” or “OR” and cannot be changed.
8. After you have OK'd each of the parameters, select one of the following actions:
- To start the infusion, make sure the slide clamp and roller clamp is open and press **RUN**.
  - To put the pump in standby mode, press **HOLD**.
  - To set up a secondary infusion (enabled using the MDL Editor), press **PROGRAM SECNDRY**.
    - For instructions on setting up a secondary infusion, refer to “Setting up a Secondary Infusion” section, beginning on page 40.
9. If you press **RUN** the infusion will start. The next display will be the Check Flow at Run error prevention system. Check the flow and confirm all clamps are open, there are no kinks or collapses in the tubing outside of the pump, drops are flowing, and vents are functioning. If everything is flowing properly, press the **YES** soft key. (See Figure 26.)

10. The run screen appears indicating that the infusion is running. (See Figure 27.)

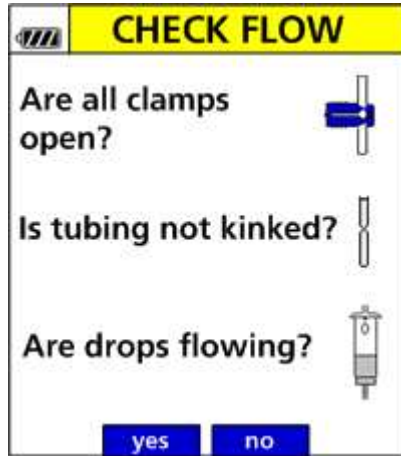

Figure 26. Check Flow at Run



Figure 27. Run Screen

## Programming the Pump Using the BASIC Mode

1. Press the ON/OFF button to turn the pump on.
2. If the previous setup needs to be erased, press YES soft key when prompted “New Patient?”. (See Figure 28.)

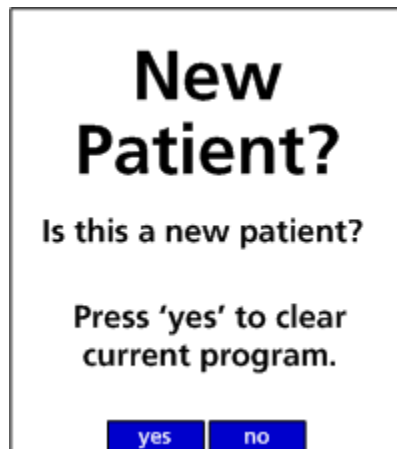

Figure 28. New Patient Screen

- Use the arrow keys to select the Care Area (nursing area) and press OK. (See Figure 29.)

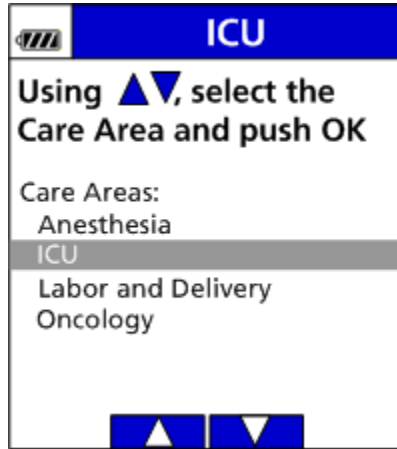

Figure 29. Select Care Area

- Using the keypad, type the letters BA, select BASIC, and press OK. (See Figure 30.)

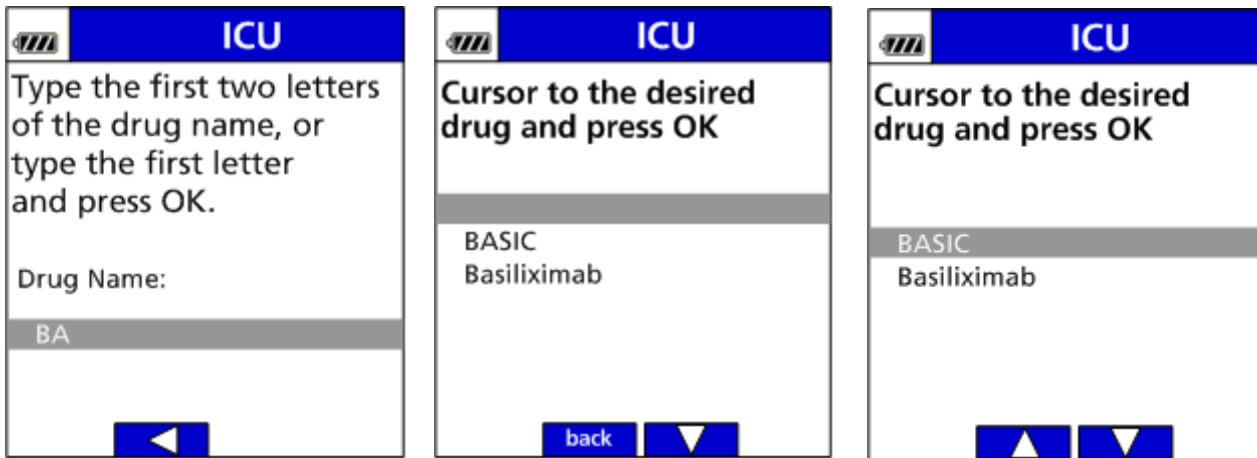

Figure 30. Select BASIC at Drug Selection Screen

5. Use the arrow buttons to indicate whether you are setting up the primary or secondary bag and press OK. (See Figure 31.)
6. Select mL/hr (See Figure 32.) or use arrow softkeys to scroll through dose rates, and press OK. (See Figure 33.)



Figure 31. BASIC Mode Bag Selection



Figure 32. Select Dose Rate



Figure 33. Arrow Soft Keys used to scroll through Dose Rates

7. If a dose rate is chosen, enter drug amount and diluent (mL) values.
8. Enter the dose or flow rate value, and press OK.
9. Enter the VTBI (Volume To Be Infused) in mL, and press OK.
10. Confirm the computed infusion time.
11. Confirm the Volume Given mL value or press CLEAR to erase it.
 

*NOTE:* VTBI counts down to zero, while volume given counts from zero up.
12. Press RUN to begin the infusion.
13. Check and confirm proper flow.
  - Press YES if drops are flowing, all clamps are open, and there are no kinks in the tubing.
  - Press NO if no drops are flowing. Open all clamps and check for kinks in the tubing. Confirm all infusion parameters are as intended.
  - Press TITRATE soft key to change dose, rate (mL/hr), or VTBI.
14. Review or reprogram the primary infusion as needed:
 

**Running**

  - Press the REVIEW soft key to view infusion information and clear volume given mL.

**Stopped**

  - Press REVIEW/PROGRAM soft key to display setup screen and change any value.
  - Press PROGRAM SECNDRY soft key to program a secondary infusion.

## Setting up a Secondary Infusion

1. Make sure you have prepared the pump for a secondary infusion, using the steps in “Preparing the Pump for a Secondary Infusion” section, beginning on page 27.
2. Follow the steps for programming the primary bag infusion as described in either “Programming the Pump Using the Dose Error Reduction System” section, beginning on page 33 or “Programming the Pump Using the BASIC Mode” section, beginning on page 37.
3. When you have finished programming the pump for the primary infusion and before you run the infusion, press **PROGRAM SECNDRY** soft key to begin programming the secondary bag. (See Figure 34.)



Figure 34. Program Secondary after Primary Setup

4. If pump is already running press **STOP** (See Figure 35.), followed by **REVIEW/PROGRAM** soft key (See Figure 36.), then **PROGRAM SECNDRY** (as displayed on pump setup screen) soft key (See Figure 37.).



Figure 35. Run Screen

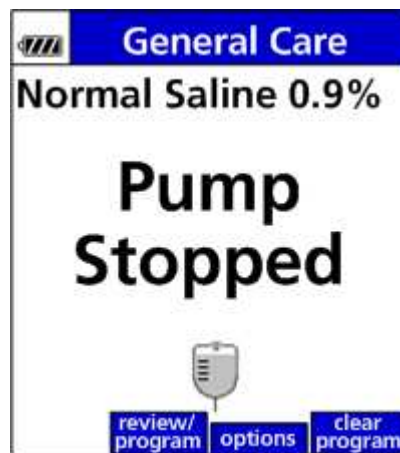

Figure 36. Infusion Stopped



Figure 37. Setup Screen



5. If the drug is to be delivered using the Dose Error Reduction System, select the drug from the Drug Library:

**NOTE:** The drug must be pharmacy / hospital-approved for delivery as a secondary line.

- Using the keypad, type the drug's first two letters and press OK. All drugs beginning with those two letters will appear. (See Figure 38.)

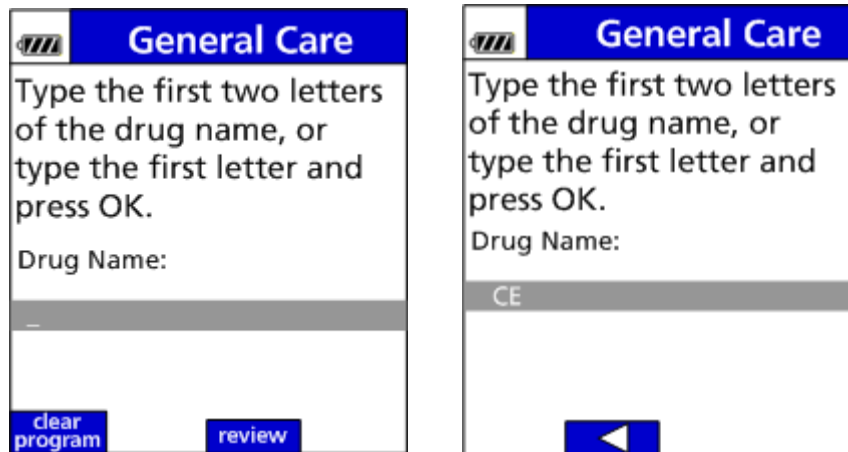

Figure 38. Secondary Drug Entry

- Use the arrow keys to scroll to the desired drug and press OK. (See Figure 39.)

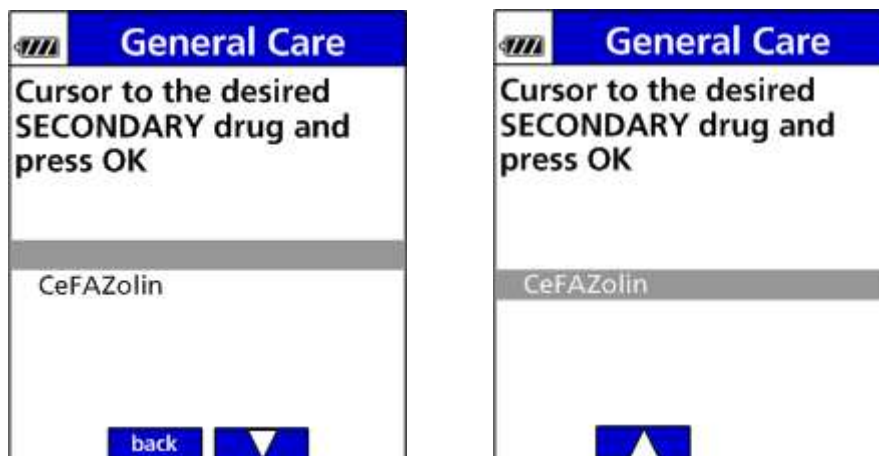

Figure 39. Secondary Drug Selection.

6. Press **OK** to select secondary bag or use the arrow soft keys to change to primary bag. (See Figure 40.)
7. Confirm the values on the setup screen:
  - Confirm the drug and concentrations are correct (if selected).
  - Enter all required data, and press **OK** after each entry.
  - To avoid infusing residual amounts of the secondary container at primary flow rates, be sure to properly set the secondary VTBI value. Secondary VTBI should equal secondary bag volume.

**NOTE:** A “watermark” indicator(See Figure 41.) is displayed behind the parameter data to help distinguish the secondary (2) setup screen from the primary (1) setup screen. This watermark does **not** appear on primary-only infusions.



Figure 40. Secondary Bag Selection



Figure 41. Secondary Infusion Setup Screen

8. Press **RUN** to begin the secondary infusion.
9. Confirm the flow from the secondary drip chamber (**YES/NO**). (See Figure 42.)
  - **YES** – Secondary infuses as programmed until completion with automatic transition to primary (unless Secondary Callback is **ON**).
  - **NO** – Hang secondary bag above primary bag, confirm secondary clamp is open and flow from the secondary container, then press the **YES** or **NO** soft key.
    - **YES** – Secondary infuses as programmed until completion with automatic transition to primary (unless Secondary Callback is **ON**).
    - **NO** – Apply clamp to primary line above upper Y injection site, and press **OK** to confirm primary is clamped.

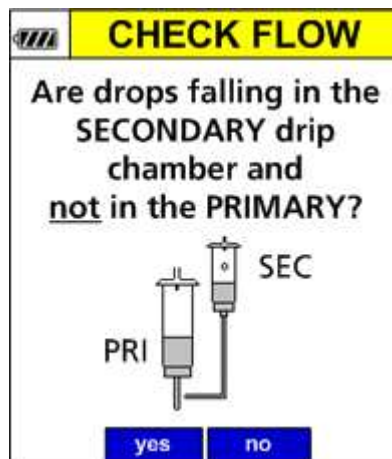

Figure 42. Secondary Check Flow at Run

The “two bag” icon denotes the secondary is running. (See Figure 43.)

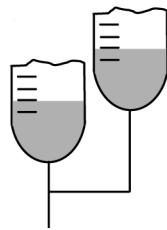

Figure 43. Secondary Icon

10. If primary line is clamped, the secondary infuses until completion and the rate will decrease to a KVO (keep vein open) rate with alarm. (See Figure 44.)
11. Press STOP.
12. Select Infusion.
  - Press the **SECONDARY** soft key to return to the secondary setup. (See Figure 45.) This allows reprogramming of the last secondary infusion or with a new drug.
  - Press the **begin PRIMARY** soft key to return to the primary infusion. (See Figure 45.) Then remove clamp from primary and press **OK** to begin primary infusion.



Figure 44. Secondary Completion; KVO Alarm

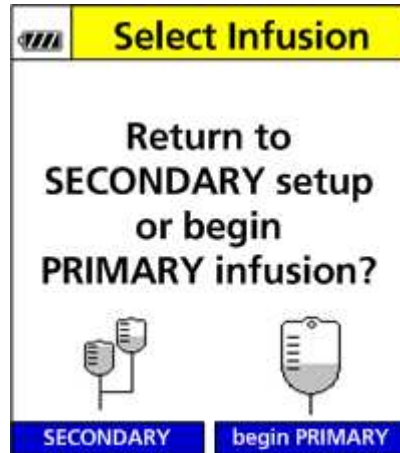

Figure 45. Select Infusion



Figure 46. Select Desired Secondary Infusion Screen

13. Confirm flow from primary drip chamber (YES/NO).
  - **YES** – Primary infuses as programmed.
  - **NO** – Close clamp on secondary line. Press **OK** to confirm secondary line is clamped.
14. Upon completion of the secondary infusion and once the transition is made to the primary infusion, a “one bag” icon shall replace the “two bag” icon on the run screen.

**NOTE:** Upon completion of the secondary infusion, the clamp on the secondary set should be closed to prevent any remaining fluid in the secondary bag from being delivered at the primary delivery rate.

## Clearing the Secondary Mode While Returning to the Primary Infusion

1. Press **STOP**.
2. Press **CLEAR PROGRAM** soft key.
3. Press **PROGRAM SECNDRY** soft key.
4. Press **YES** soft key.
5. Close the clamp on the *secondary* line above the upper Y injection site or remove secondary container and tubing.

---

**CAUTION:** Close the clamp on the secondary line or remove the secondary container administration to prevent the secondary medication from flowing when the Primary mode is intended.

---

6. Press **OK** to continue.
7. The primary review screen appears.
8. Press **RUN** to start the primary infusion.
9. Check for flow and confirm that all clamps are open, there are no kinks in tubing, and drops are flowing. If everything is flowing properly, press the **YES** soft key.

## Secondary Callback – Assigned to a Secondary Drug in the Drug Library

Secondary Callback is a feature that causes the pump to drop to the KVO Rate (1 mL/hr) at the completion of the secondary infusion and sound an audio alarm to call the clinician back.

1. If Secondary Callback is enabled as optional (per drug in the Drug Library) a dialog box shall be displayed at the completion of programming a secondary infusion that asks if the clinician would like to be called back at the completion of the secondary infusion. (See Figure 47.)



Figure 47. Secondary Callback Dialog Box

- If YES is pressed, a “callback” icon will be displayed on the RUN screen, alternating with the VTBI (bag) icon, during the secondary infusion to indicate that the callback feature is active. (See Figure 48.)

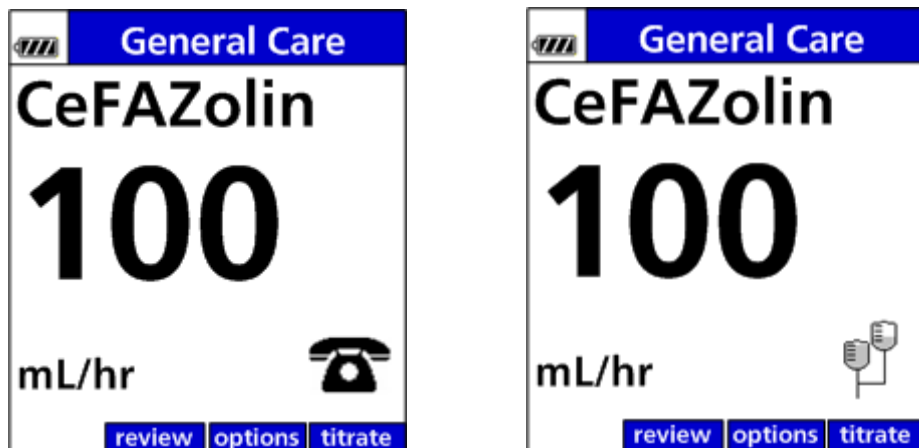

Figure 48. Alternating Run Screens with Secondary Callback Enabled

- If NO is pressed, the “callback” icon will not be displayed and the pump will automatically transition to the primary infusion upon completion of the secondary infusion.

Master Drug Library Editor allows Secondary Callback configuration as **REQUIRED**, **OPTIONAL**, or **NEVER**:

- If **REQUIRED**, the pump will not offer the clinician the Callback dialog box and the pump will drop to the KVO Rate at the completion of the secondary infusion and sound an audio alarm to call the clinician back.
- If **OPTIONAL**, the clinician will be presented with the Callback dialog box upon completion of programming the secondary infusion. Press **OPTIONS** to change callback status during secondary infusion.
- If **NEVER**, the pump will automatically transition to the primary infusion upon completion of the secondary infusion.

When secondary infusion completes, pump stops (KVO rate). If Callback is enabled, an alarm occurs. (See Figure 49.)

1. Press STOP.
2. Return to SECONDARY SETUP or begin to PRIMARY INFUSION displays. (See Figure 50.)



Figure 49. Secondary Completion Screen

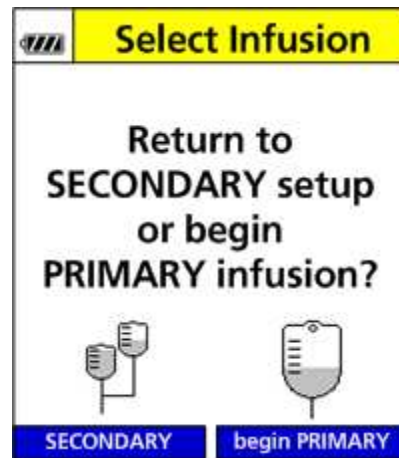

Figure 50. Select Infusion Screen

## Programming a Loading Dose

A loading dose is an initial higher dose of a medication or fluid delivered once at the start of an infusion. When programming an infusion using DERS, you can select a loading dose.

1. A loading dose can be enabled using Drug Library and infuses at the beginning of an infusion.
2. A loading dose amount, time, and limits can be assigned to drugs in the Drug Library.
3. A loading dose icon (syringe) is displayed next to the “Primary or Secondary Bag” line on a completed setup screen. (See Figure 51.)



Figure 51. Loading Dose Icon

4. After all Primary Infusion values are entered, a Loading Dose dialog box displays: “Do you want to deliver a Loading Dose from the PRIMARY (or SECONDARY) bag? (YES/NO).”(See Figure 52.)

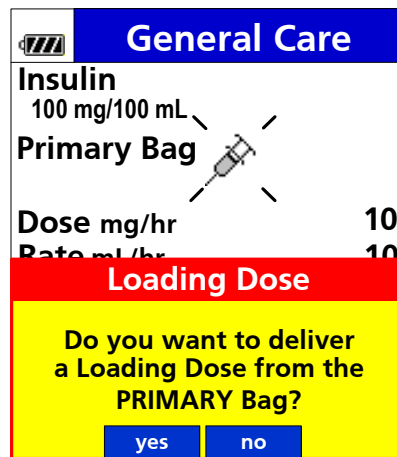

Figure 52. Loading Dose Dialog Box

5. If you select YES, the loading dose setup screen displays.
6. Enter all required data, and press OK after each entry.
7. Press RUN to start the delivery of the Loading Dose.
8. Check for flow and confirm that all clamps are open, there are no kinks in tubing, and drops are flowing. If everything is flowing properly, press the YES soft key.
9. To cancel the Loading Dose during infusion, the user can press the CANCEL soft key.

**NOTE:** At the completion of the loading dose, transition to the Primary Infusion rate is automatic.



## Programming a Bolus

A Bolus is a higher dose of medication or fluid, and can be delivered throughout the infusion.

- Can always be delivered in BASIC mode and is optional in DERS (if configured in the Drug Library).
- Amount, time and limits can be assigned to drugs in the Drug Library by using the Master Drug Library Editor.
- Can be programmed while the pump is stopped or while infusing

To program a Bolus while the pump is stopped or infusing:

1. Press the **BOLUS** soft key. The bolus setup screen appears.
2. Enter all required data, and press **OK** after each entry.
3. Press **RUN** to start bolus delivery.
4. To cancel the Bolus during infusion, the user can press the **CANCEL** soft key

*NOTE:* At the completion of the Bolus, transition to the Primary Infusion rate is automatic.

## Multi-Step Programming

The Multi-Step Programming Mode allows the pump to be programmed with up to 10 individual infusion rate steps using either the Dose Error Reduction System or BASIC Programming Operations. Primary infusions are eligible for use in the Multi-Step Programming Mode, if selected as “Primary Only Multi-Step” or “Primary or Secondary” bag selection in the Drug Library.

1. Press the **ON/OFF** key to turn the pump on.
2. If the prior setup needs to be erased, press **YES** soft key.
3. Use the arrow keys to select the Care Area and press **OK**.
4. **If the drug is to be delivered using the Drug Library**, select the drug as described in “Programming the Pump Using the Dose Error Reduction System” section, beginning on page 33.
5. **If the drug is to be delivered using the BASIC mode:**  
Type the letters **BA**, select **BASIC**, and press **OK**.
6. At the bag selection screen, select the primary or secondary bag, select **Primary Bag** and then press the **MULT-STEP** soft key to enter the Multi-Step Programming Mode.

*NOTE:* The Multi-Step Program Mode is not available for the primary bag when a secondary program exists in memory.

*NOTE:* If the selected drug has been configured in the Drug Library as a “Primary Only Multi-step” infusion, bag selection will be bypassed and the Multi-Step Program Mode setup screen will be displayed.

*NOTE:* Multi-Step Program Mode is not available as a secondary infusion.

7. In the Multi-Step Programming Mode, continue with the setup as described in the BASIC or DERS programming sections.

A step indicator bar is located at the top of the screen. The bar shows which steps within the program have parameter data (a small white highlight) and which step is currently being viewed (a tabbed white highlight).

8. When the setup of an individual step has been completed, press **OK** to advance and program the next step.

When the 10th step has been programmed, the program schedule is complete and no more steps may be programmed.

*NOTE:* Only one step is necessary to start a program however it must be the first and only programmed step. The pump may not be started if setup data is missing from any step in the program. Any parameter data missing within the program shall be identified in a popup message when the user starts the pump.

9. View the setup data for any programmed step by moving the highlight (using the up arrow soft key) to the step indicator bar located at the top of the setup screen and then using the left and right arrow soft keys to move from step to step.

*NOTE:* A one-second delay exists from the time a step is selected and when its setup data is displayed to allow rapid scrolling along the step bar.

- If the infusion is stopped, you can change any setup data by pressing **REVIEW** and navigating to that step and pressing **OK** to move to the values that must be changed.
- If the pump is running, you can view any programmed step by pressing the **REVIEW** soft key; however, no values can be changed with the exception of the Volume Given value, which can be cleared by pressing the **CLEAR** soft key.

10. Press **RUN** to start the program.

The run screen appears as described in the mL/hr or Dose Error Reduction System sections with the addition of a program step indicator. This indicator displays the current program step as “Step x of y”, where x is the current step being delivered and y is the total number of programmed steps.

Pump will automatically advance to programmed steps while infusing.

11. Check the flow and confirm all clamps are open, there are no kinks in tubing, and drops are flowing. If everything is flowing properly, press the **YES** soft key.
12. When the program completes, press the **STOP** key.

The program schedule automatically resets itself and may be restarted without entering/re-entering any setup data.

*NOTE:* Always verify current program parameters for each step prior to starting a new infusion.

The program will be retained indefinitely during power off cycles until reset. To reset the program press the **RESET** soft key from the program stopped screen.

### Clearing the entire multi-step program

To clear the entire program, press the **CLEAR PROGRAM** soft key and answer **YES** to the confirmation screen.

### Clearing an individual step

To clear the setup data from any individual step:

1. Make sure the pump is stopped.
2. Press the **REVIEW** soft key
3. Use the arrow soft keys to move the highlight to the desired step in the step bar.
4. Press the **CLR STEP** soft key.

*NOTE:* Clearing a step does not delete that step unless it is the last step in the program.

## Cyclic TPN Mode

The Cyclic TPN Mode is selected in the Drug Library. It is designed to deliver TPN in an automatic ramp up, main rate, and taper down program. The infusion schedule is calculated with the rates and volumes for 10 ramp steps up occupying 10% of the total infusion time, 10 taper down steps occupying another 10% and the main rate accounting for the remaining 80% of the infusion time.

To program Cyclic TPN:

1. Press the **ON/OFF** key to turn the pump on.
2. Use the arrow keys to select the Care Area and press **OK**.
3. Select Cyclic TPN from the Drug Library.
4. Enter the program VTBI, and press **OK**.
5. Enter the program time, and press **OK**.
6. View display screen with main rate, VTBI, prog time, ramp up time, main step time, taper down time, and volume given mL.
7. Press **RUN** to start infusion.
8. Check the flow and confirm all clamps are open, there are no kinks in tubing, and drops are flowing. If everything is flowing properly, press the **YES** soft key.
9. Observe mL remaining value and green **INFUSING** icon.
10. Press **REVIEW** soft key to display program status.
11. To begin early taper down, press **TAPER DOWN** soft key.
12. “Are you sure you want to begin the taper down?” dialogue box displays on screen. Confirm by pressing the **YES** soft key.

13. When pump is stopped, **RESET** soft key allows user to start the program from the beginning.
14. At completion, the pump infuses at KVO. Press **STOP** to automatically reset the program from the beginning.

**NOTE:** Once the TPN program starts delivery, no changes to the infusion parameters can be made.

## Titration

You will receive a dialog box if the dose rate limits defined in the Drug Library for the drug are exceeded.

- **Soft dose rate or mL/hr limits** may be exceeded by pressing **OK** followed by pressing the **YES** soft key to accept or the **NO** soft key to decline the dose rate displayed in the dialog box.
- **Hard dose or mL/hr limits** cannot be exceeded. Re-enter rates within hard limits.
- **Single Step Titration (Rate advisory)** – dose or mL/hr rate entered is increased or decreased by a % (set in the Drug Library) above or below the current rate.
  - Press **YES** to accept or **NO** to decline the change displayed in the dialog box.
  - In **BASIC** mode the rate advisory is set for an increase (+) of 101% and a decrease (-) of 51% and cannot be changed.
  - The rate advisory is set for an increase (+) of 500% and a decrease of (-) 99% if the selected Care Area name contains “Anesthesia” or “OR” and cannot be changed.

### To titrate dose without stopping the pump:

1. Press the **TITRATE** soft key. (See Figure 53.)
2. Dose is displayed. Observe the displayed soft dose limits. (See Figure 54.)



Figure 53. Run Screen .

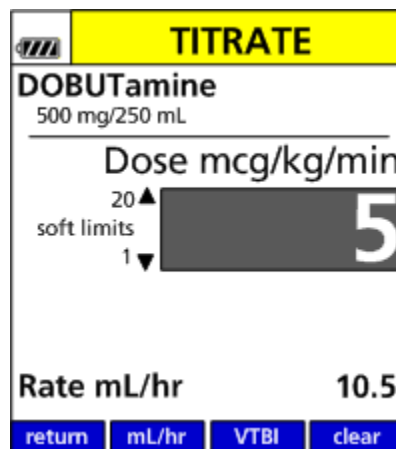

Figure 54. Titrate Screen

3. Enter a new dose. (See Figure 55.)

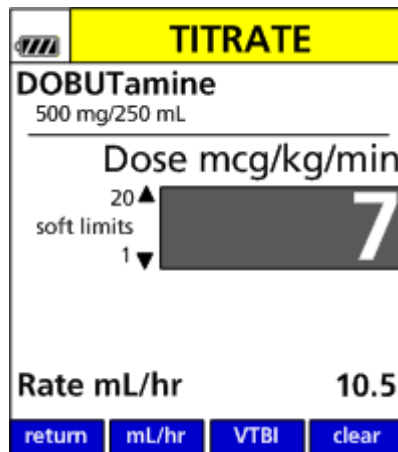

Figure 55. Titrate Screen with New Dose

**To titrate rate mL/hr without stopping the pump.**

1. At the run screen, press TITRATE soft key. (See Figure 56.)
2. At the titrate screen, press mL/hr soft key.(See Figure 57.)



Figure 56. Run Screen

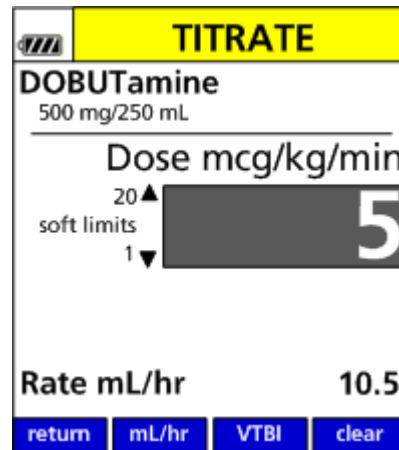

Figure 57. Titrate Screen

3. Observe the displayed mL/hr soft limits.
4. Enter a new mL/hr flow rate.
5. Press OK.

If soft limits are exceeded, press YES to accept new value or NO to return to prior value. Values exceeding the hard limits set in the Drug Library will not be accepted by the pump.

**To titrate VTBI without stopping the pump.**

1. At the RUN screen, press the TITRATE soft key. (See Figure 58.)
2. At the titration screen, press the VTBI soft key. (See Figure 59.)
3. Enter new value, and press OK. (See Figure 60.)



Figure 58. Run Screen

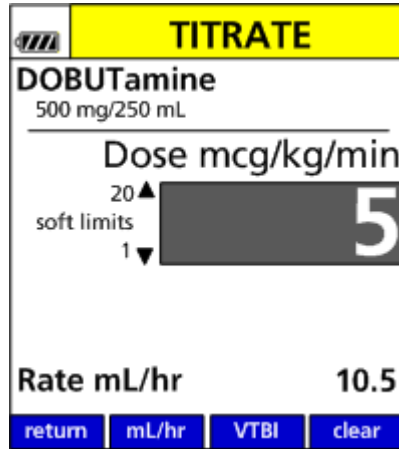

Figure 59. Titrate Screen

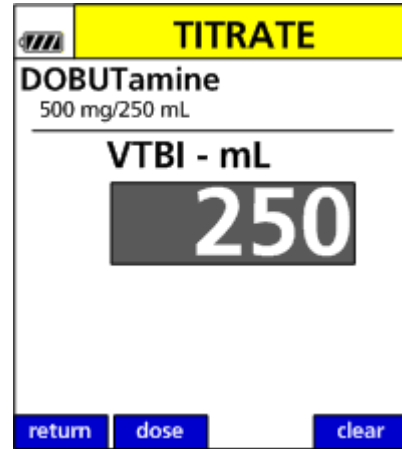

Figure 60. Titrate VTBI Screen

## Delayed Run

1. If Delayed Run is enabled (per drug in the Drug Library) the start of any programmed infusion can may be delayed by up to 12 hours. On the infusion set up screen, enter any value between one minute and twelve hours (00:01 to 12:00, hr:min) for the delay run parameter and press **OK**.
2. Once a delay time is entered, the infusion programming is complete, and the set is loaded, press the **RUN** key to begin the infusion delay timer.
3. The delay running screen appears with the remaining delay time shown in a flashing format.
4. When the delay time period expires, the pump begins delivery of the programmed infusion. Check Flow will display.

## Stopping/Canceling the Delay Timer

While the delay is running it may be stopped or cancelled.

- To **stop the delay**, press the **STOP** key. The display updates to **DELAY STOPPED** and the delay timer is paused and no longer flashes.
- To **cancel the delay**, press the **CANCEL** soft key. The remaining delay time is cleared and the display updates to **PUMP STOPPED**.

## Changing the Delay Timer

The remaining delay time value may be changed by pressing **STOP**.

1. Press **REVIEW/PROGRAM** soft key to display the setup screen.
2. Move the cursor to the delay value and enter the new desired delay time and press **OK**.

*NOTE:* The new delay time is immediately applied. The delay time value may not be cleared while the delay is running.

## Weight Confirmation

The Weight Confirmation screen (See Figure 61.)(set up in the Drug Library) requires the patient weight parameter to be re-entered to confirm correct entry. If values do not match Values Differ popup message will appear. Press **OK** and enter accurate value.



Figure 61. Weight Confirmation

# PUMP OPERATION

## Operating Tips

### Follow all prompts on the pump screen.

- The Operator must press **OK** to confirm all entries and changes.
- Follow all prompts on screen to clear alarms.

### Be sure to load sets properly.

- Start with a fresh section of tubing loaded in the pump, make sure there is enough tubing for patient movement.
- To open the pump door, insert the gravity IV set's slide clamp fully into the keyhole.
- Observe the Direction of Flow diagram, left of the pumping mechanism with door opened.
- Load tubing tautly, from top to bottom in loading points 1, 2, 3 and 4, following the red/green prompts.
- Close the door with thumb pressure over both door hooks, which is at the top of the door and the bottom of the door.
- Open the slide clamp by pulling it straight up and out of the keyhole, while holding the tubing around it down to provide strain relief.

### Use the Dose Error Reduction System (DERS).

- DERS protects against human errors that could cause Adverse Drug Events.
- BASIC mode can not detect many of the human errors that DERS can. BASIC mode does possess some Gen 2 features such as Check Flow at Run, Secondary Error Prevention, and Single Step Titration.

### Confirm Safe Accurate Pump Operation

- Confirm at startup and periodically thereafter drops are falling in the drip chamber at the expected rate, IV or Container vents are properly functioning, tubing clamps are in the proper positions, and tubing is free from kinks or signs of collapse outside the pump.

### Do not drop the AC Power Adaptor.

- The AC Power Adaptor has a built in power supply and is an electronic device. It is not simply a plug, and it will break if repeatedly dropped.
- Keep the power cord plugged in whenever the pump is not in use.

### Follow secondary procedures.

- Use a secondary hanger fully extended to drop primary containers below secondary containers.
- With secondary rates above 300mL/hr, look for and clamp off primary line siphoning.



## Placing the Pump in STANDBY (Hold)

You can place the pump in a standby state to prevent the occurrence of the Inactivity Alarm (see “Alarms” section, beginning on page 59) for the period of time specified in the User Settings / Alarm Settings menu option. The default setting is to provide an infinite period of time; however, this value may be changed from one minute up to 99 hours and 59 minutes.

1. Load the set and complete the infusion setup.

Once setup has been completed and the highlight is on the Volume Given mL value, a display appears stating that the pump may either be started or it may be placed in standby mode.

2. To place the pump in standby, press the **HOLD** soft key. (See Figure 62.)



Figure 62. HOLD Soft Key

- When standby is activated, the IN STANDBY popup message, (See Figure 63.), is displayed in a flashing format.

*NOTE:* If the standby period is set to infinite, the time value in the display will be replaced with a dashed line.

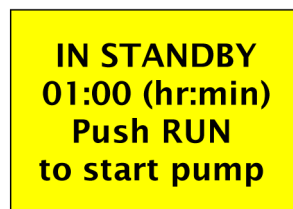

Figure 63. IN STANDBY Popup Message

3. While in standby, press **RUN** at any time to begin the infusion. Pressing any other key or opening the pump door cancels standby mode.
4. After pressing **RUN**, confirm check flow.

*NOTE:* To place a pump in standby after an infusion has started. Press **STOP, REVIEW** soft key, followed by the **HOLD** soft key.

## Operating the Keypad Lock

The keypad can be locked in two ways:

- Manually - by entering the keypad lock code
- Automatically - by activating the Auto Keypad Lock feature in the Drug Library.

---

**CAUTION:** Use Keypad Lock to Avoid Tampering

---

### Manually locking the keypad

To lock the keypad, enter the code 429 (“K”, “E”, “Y”).

*NOTE:* 429 is the default keypad lock code. Refer to the Library Configurations section in the MDL User Manual (P/N 41020) to change the keypad lock code. Keypad lock code is set hospital wide in the Drug Library and may be 1 to 4 digits (1-9 only, zero can not be used).

This code is entered when the pump is in the run mode to prevent unauthorized activation of specific key entries. A popup message appears briefly indicating the keypad has been locked. If locked, pressing any key will also result in this popup message being displayed. The Key lock icon is shown on the top left corner of the screen. 

When the keypad is locked, you can press the **REVIEW** soft key to view infusion setup data. However, no values can be changed and therefore navigation from value to value is not allowed when the keypad is locked.

The keypad allows certain alarm conditions to be silenced and cleared while in the Keypad Lock mode.

The code must be re-entered to unlock the keypad. If the keypad is unlocked while reviewing the setup data and the pump is not stopped, the keypad will automatically relock upon return to the run screen.

### Automatically locking the keypad

In the MDL, you can set the keypad to lock automatically by activating the Auto Keypad Lock feature by Care Area.

Keypad will be automatically locked 60 seconds after the run key is pressed.

Passcode must be entered on the keypad to unlock.

Always guard the keypad lock code from unauthorized view or access. Uncontrolled access by a patient or family member may cause injury to the patient.

For more information about this feature, refer to the Care Area Configurations section in the MDL User Manual (P/N 41020).

## ALARMS

The Spectrum Pump will display alarms when specific conditions exist. Depending on the priority, these alarms can be an audible tone and/or an alarm message is displayed on the pump screen. The message states the reason for the alarm and contains prompts for clearing the alarm.

**NOTE:** The following alarms will utilize the drug audio alarm setting entered in the MDL Editor when the drug is selected at the pump: Inactivity; Air in line; Air Accumulation; Upstream Occlusion; Downstream Occlusion; Slide Clamp Closed; KVO; Bag Near Empty. (See Figure 64.)

The figure consists of six panels arranged in two rows of three. The top-left panel shows a pump screen with an 'INACTIVITY ALARM' message. The other five panels show specific alarm messages with instructions and icons of the pump.

Alarm Message	Instructions	Action
<b>INACTIVITY ALARM</b> Push any key to silence for 2 min	None	silence
<b>AIR-IN-LINE</b> Upstream occlusion may exist	Check for kinks and closed clamps above the pump	silence
<b>AIR LIMIT EXCEEDED</b> Upstream occlusion may exist	Check for kinks and closed clamps above the pump	silence
<b>UPSTREAM OCCLUSION</b>	Open clamps and tube kinks above pump, then press RUN	silence
<b>DOWNSTREAM OCCLUSION</b>	Eliminate closed clamp, kinked tube, or clogged filter or catheter to restart pump.	silence
<b>BAG NEAR EMPTY</b>	PUMP IS RUNNING < 30 minutes remain Press OK to confirm	None

Figure 64. Example Alarms Messages

## Silencing an Alarm

To silence the audio tone for an alarm, press the **SILENCE** soft key or any key on the keypad. This silences the alarm tone for 2 minutes. If the alarm has not been cleared after 2 minutes, the alarm tone will resume.



## Clearing an Alarm

To clear an alarm, follow all of the prompts and instructions in the alarm message. The alarm clears after you have corrected the alarm condition and followed all of the prompts.

## Alarm Messages

Alarm	Action
AIR-IN-LINE	Check for kinks in tubing or closed clamps above the pump that may result in an upstream occlusion. Evaluate tubing for presence of air. Press <b>OK</b> and then press <b>RUN</b> to advance small bubbles past the air detector. Each press of <b>RUN</b> advances approximately 0.1mL. Use a syringe to aspirate air from the lower Y injection site or re-prime the set.
AIR LIMIT EXCEEDED	The pump will alarm when greater than approximately 1mL of accumulated air has been detected in 15 min.
AUDIO	The audio alarm may be silenced for 2 minutes by pressing any key. Audio level alarm is set in the Drug Library. Audio level alarm settings include; use pump setting, low, medium, and high.
BATTERY MISSING	Battery not detected. Confirm that the Battery is properly installed and securely latched into the pump.
DEPLETED BATTERY	The Battery is fully depleted and unable to power the pump. To recharge the Battery and continue the infusion, plug the pump's AC Power Adaptor into an AC outlet. Confirm that the adaptor's Power Cord Connector is attached to the pump.
DOOR NOT FULLY CLOSED / SET OUTSIDE CHANNEL	The pump's door has not closed and latched correctly. Close the roller clamp below the pump. Then open the door by inserting the slide clamp into the keyhole. Re-load the IV set following the on screen prompts. Once the IV set has been loaded properly, close the pump's door ensuring both door latches shut securely.

<b>Alarm</b>	<b>Action</b>
DOOR OPEN	Slide clamp is inserted into the keyhole and opens the door while the set is loaded. Close the roller clamp. Follow display prompts.
DOWNSTREAM OCCLUSION	Eliminate a closed clamp, kinked tubing, positional catheter, clotted catheter, clogged IV filter or other sources of occlusion below the pump.
DOWNSTREAM PRESSURE LIMIT - RESET SETTING	The downstream pressure limit differs from Care Area default (set in the Drug Library). Select <b>YES</b> to reset or <b>NO</b> to keep the current setting.
INACTIVITY ALARM	The pump has been inactive for 2 minutes and no action has been taken. Follow the on screen prompts and resume or restart the pump by pressing <b>RUN</b> .
IN STOP - SLIDE CLAMP CLOSED	Open slide clamp and press <b>RUN</b> (or unload set).
LOW BATTERY	The low battery alarm threshold has been reached. Plug the AC Power Adaptor into the pump and into the AC source outlet as soon as possible to recharge the Battery.
PRIMARY INFUSION COMPLETE	The Primary Infusion Volume To Be Infused (VTBI) has counted down to zero. The pump is running at a Keep Vein Open rate (KVO rate) or the actual infusion rate, whichever is lower. The Drug Library default KVO rate is set at 1mL/hr in the Drug Library.
SECONDARY INFUSION COMPLETE	The Secondary VTBI has counted down to zero. A secondary infusion with Secondary Callback enabled will run at the pump's default KVO rate of 1mL/hr. If Secondary Callback is disabled when Secondary VTBI has counted down to zero, the pump will automatically transition back to the previously programmed primary rate.
SLIDE CLAMP CLOSED	Open slide clamp and press <b>RUN</b> or reload the set.
SYSTEM ERROR	An internal fault has been detected. Some faults can be cleared by either cycling power (off, then on) or by turning the power off, disconnecting the battery, reconnecting it several seconds later, and pressing the <b>ON</b> key. If neither procedure clears the fault, return the pump for service.
UPSTREAM OCCLUSION	Eliminate the occlusion or flow restriction by checking for an upstream (above pump) closed clamp, kinked or collapsed IV tubing outside the pump, closed burette valve, and malfunctioning or closed IV set or burette air vent. Press <b>RUN</b> to start infusion. Verify patency by confirming drop rate is consistent with programmed rate.

Alarm	Action
<p>UPSTREAM OCCLUSION ALARM SUSPENSION</p>	<p>A drug or fluid that produces micro-bubbles in solution can cause nuisance upstream occlusion alarms. This is most likely associated with certain drugs identified as “effervescent” and also with cold fluids that are warming during infusion. A drug configuration in the Drug Library allows the clinician to temporarily suspend the upstream occlusion alarm on the pump if the clinician considers the alarm to be a nuisance. The suspension prompt appears after two consecutive upstream occlusion alarms and a positive confirmation on the check flow display screen. (See Figure 65.)</p> <p>This dialog allows the user to suspend the alarm for the currently programmed infusion. The alarm will automatically be enabled when:</p> <ol style="list-style-type: none"> <li>1. The <b>STOP</b> key is pressed.</li> <li>2. The Door is opened.</li> <li>3. The Infusion Transitions from Secondary to Primary.</li> <li>4. Any alarm condition that stops the pump and the pump is turned <b>OFF</b> and then back <b>ON</b>.</li> </ol> <hr/> <p> <b>WARNING:</b> Upstream Occlusion Alarm Suspension feature should not be used when delivering critical drugs where the risk of flow stoppage due to undetected upstream occlusions outweighs that of flow interruption due to nuisance upstream occlusion alarms.</p> <hr/> <p> <b>WARNING:</b> Upstream Occlusion Alarm Suspension feature should not be used for drugs delivered in RIGID containers since the flow restrictions caused by lack of proper container venting may be difficult to recognize when troubleshooting an alarm condition.</p> <hr/>

Alarm	Action
<p>UPSTREAM OCCLUSION ALARM SUSPENSION (Continued)</p>	<p><i>NOTE:</i> Upstream Occlusion Suspension feature is enabled by default in the Drug Library for BASIC mode.</p> <hr/> <p> <b>WARNING:</b> Upstream Occlusion Alarm Suspension feature should only be used after the operator visually observes positive line flow.</p> <hr/> <div style="display: flex; justify-content: space-around;"> <div data-bbox="680 732 1078 1184"> </div> <div data-bbox="1117 732 1515 1184"> </div> </div> <p>Figure 65. Upstream Suspension Prompts for Primary and Secondary Infusions</p>
<p>VERY LOW BATTERY</p>	<p>Less than ½ of the low battery capacity remains. The AC Power Adaptor should be plugged in immediately. The tutorial to check the AC Power Adaptor will automatically begin (see “APPENDIX F - Low / Very Low Battery Tutorial” section, beginning on page 103).</p>

## Preventing Nuisance Alarms

Check the following items to prevent nuisance alarms:

- Remove all air from IV sets. While priming, invert and tap air from all Y sites and back check valves.
- Do not administer extremely cold or hot solutions. Warm solutions to room temperature before use to help prevent nuisance upstream occlusion or air-in-line alarms caused by out-gassing of micro bubbles.
- Effervescent, foamy, or frothy solutions can result in nuisance upstream occlusion alarms.
- Invert (do not shake) IV bags that need to be mixed.
- Fill drip chambers half way.
- Do not load pumped on IV set tubing in the pumping channel or in the air and occlusion detector areas.
- Use only compatible IV sets as labeled and identified on the SIGMA pump.
- Keep the tubing channel clean and dry.
- Avoid empty IV containers by properly setting VTBI values.
- Plug in pump's AC Power Adaptor to maintain battery charge.
- Using the Low Downstream pressure setting at flow rate setting above 500 mL/hr may cause Downstream nuisance alarms that are created by IV set pulsation.

## Managing Bolus before Occlusion (Downstream) Release

### Managing unintended small bolus releases when clearing downstream occlusions

When a downstream occlusion alarm occurs, pressure and a small volume of <0.98 mL of fluid (the “bolus”) builds up between the pump and the point of occlusion. When it might be harmful to infuse the bolus into the patient, simultaneously withdraw 0.9 mL of fluid from the lower Y site of the IV set and eliminate the source of the occlusion.

## Battery Warning Levels

The pump provides three warning levels as the battery capacity decreases while operating on battery power. These levels are:

- Low Battery
- Very Low Battery
- Battery Depleted

There is ample time between the alarms for the pump to be plugged into main power. The troubleshooting tutorial also automatically pops up on the pump screen to guide the user through the process. See “APPENDIX F - Low / Very Low Battery Tutorial” section, beginning on page 103.

If the pump is not plugged in, the battery continues to slowly discharge even if the pump is turned off.



### Low Battery

When the battery is low, the pump sounds a triple-beep audio alarm every 5 seconds. Press OK to temporarily suspend this alarm. While suspended, the Low Battery status will be indicated in the alert bar and a tone will be generated once every five minutes to remind the operator of the Low Battery status. (See Figure 66.)



Figure 66. Low Battery Alarm

If the pump is not plugged in or the alarm is not acknowledged after 2 minutes, the alarm volume increases and the troubleshooting tutorial automatically begins.

When the Low Battery warning initiates, a minimum of 30 minutes of runtime remains.

### Very Low Battery

If the battery level drops below the low-battery level, the message changes to Very Low Battery and begins to flash. The back light also dims to reduce battery usage. (See Figure 67.)

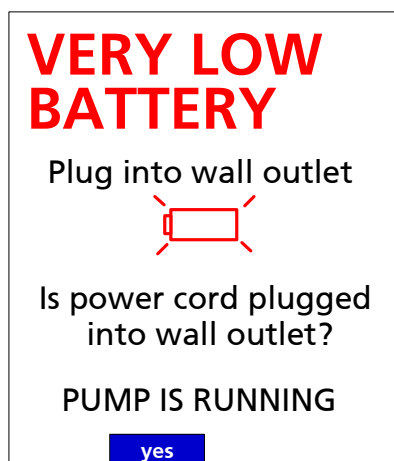

Figure 67. Very Low Battery Alarm

The troubleshooting tutorial starts automatically.

When the Very Low Battery warning initiates, a minimum of 15 minutes of runtime remains.

### Battery Depleted

If the battery level drops below the Very Low Battery level, the message changes to Battery Depleted. (See Figure 68.)

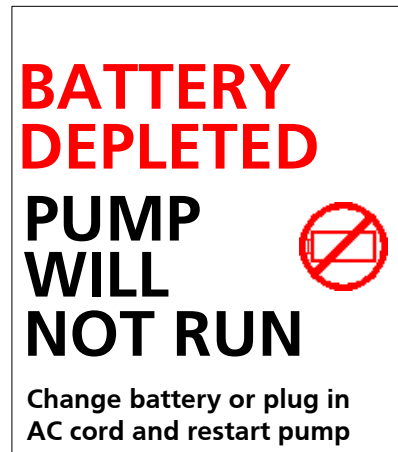

Figure 68. Battery Depleted Alarm

The pump will stop running. If the pump is not plugged in within 3 minutes, the pump will shut itself off.

## CLEANING AND STORAGE

The SIGMA Spectrum should be cleaned and disinfected for each patient use according to facility protocol.

---

**CAUTION:** Do Not Improperly Clean Pumps

- During cleaning, do not allow fluid to seep inside pump (especially through front panel door latch holes or back case speaker holes) or severe damage may occur. Wipe on minimal amounts of cleaning fluids, never spray them. Use only SIGMA specified compatible cleaning fluids. Do not autoclave or ETO sterilize pumps.
  - Always wear gloves when cleaning a pump.
  - Alcohols are flammable and should not be used for Battery cleaning/disinfection.
  - Alcohols should only be used in well ventilated spaces.
  - When cleaning the battery pack, care should be taken to prevent shorting of the pack's exposed terminals.
- 

### Compatible Cleaners

For a complete list of compatible cleaning materials refer to DOC 11318 on the SIGMA website ([www.sigmapumps.com](http://www.sigmapumps.com)).

- 10% solution of bleach and water
- Up to 90% Isopropyl alcohol
- Caltech Industries Dispatch
- Steris TBQ® and Steris Germicidal Surface Wipes, Product Number 1608-GS
- Steris Coverage TB-plus Disinfectant Cleaner
- Metrex Cavicide® and Cavi Wipes™
- Ecolab Inc., EnVerros SaniMaster 4®
- Professional Disposables International, Inc., Sani-Cloth® Bleach Wipe and Super Sani-cloth®
- Micro Scientific Opti-Cide<sup>3</sup>® wipe and spray liquid
- Sklar Disinfectant Cleaner
- DisCide® Ultra Disinfecting Towelettes
- 3M™HB Quat Disinfectant Cleaner
- Medline Micro-Kill+ Wipes
- JohnsonDiversey Oxivir TB Wipes

## Cleaning the Pump

Do not use rigid cleaning instruments or spray solutions directly on the pump and its accessories.

To clean the pump:

1. Turn the pump off and unplug the AC power adaptor from the power source.
2. Place the pump in an upright position.
3. Apply the compatible cleaning agent with a dampened cloth per the manufacturers' instructions using appropriate dilution ratio.

*NOTE:* Disinfectants should remain on the pump's surface in an even, but not dripping, film for the recommended contact time for the compatible cleaning agents.

4. Open the pump's door using a standard IV set's slide clamp.
5. Clean the speaker vent, power adaptor connector, door release, keyhole and pumping channel areas with soft swabs.
6. Apply solutions sparingly to the swabs and wipe down the necessary areas.

*NOTE:* For severe solution spills it is recommended that the Standard Battery/Wireless Battery Module be removed. The Battery Pack cavity area of the pump may be cleaned by wiping down those regions with a dampened cloth as described previously.

7. Dispose of all cleaning materials (including the slide clamp) as required per facility protocol/biohazard policy.



**WARNING:** Disposal

To dispose of this device or the associated administration sets, adhere to local, state, federal and/or other governing regulations.

---

## COMPATIBLE IV SETS

### SIGMA Nitroglycerin/Lipid Sets

Connect IV containers to catheters.

Set description:

Cat No. 99021

Pump Calibration  
Hospira

Length: 99" overall  
15" PVC pumping section  
DEHP free vented drip  
chamber (60 drops/mL)  
Polyethylene lined tubing  
Priming Volume: 20mL  
Luer Lock

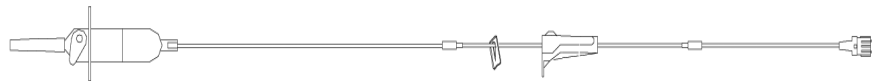

Figure 69. Nitroglycerin/Lipid Set

### SIGMA Y-Type Blood Sets

Connect Blood and Saline Bags to catheters.

Set description:

Cat No. 99031

Pump Calibration  
Hospira

Length: 104" overall  
15" PVC pumping section  
200 Micron blood filter  
Lower Y injection site  
Priming Volume: 42mL  
Luer Lock

*NOTE:* IV Sets are Latex Free

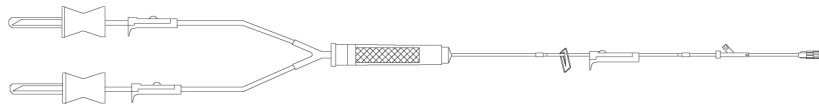

Figure 70. Y-Type Blood Set

## Compatible Baxter IV Sets

The following is a partial listing of the Baxter IV Sets compatible with the SIGMA Model Spectrum Pumps that have been calibrated for Baxter “S” I.V. set tubing. For a full listing of compatible sets refer to DOC 11182 on the SIGMA website ([www.sigmapumps.com](http://www.sigmapumps.com)).

**NOTE:** Administration sets with non-DEHP tubing in the pumping section are not intended for use with the Spectrum pump and are not included in the compatible set list.

All sets must include a Blue Slide Clamp on the section of the set to be placed into the Spectrum Pump.



No.	Brief Description
<b>Primary Set Macro (10 drops/mL)</b>	
1C8109s	Solution Set, Male luer lock, 101"
1C8160s	Solution Set, Male luer lock, 69"
1C8296s	Solution Set, Male luer lock, 125"
2C6401s	Solution Set, Interlink Y-Site (1 ea) with luer lock adapter, lever lock cannula, 76"
2C6419s	Solution Set, Interlink Y-Site (1 ea) with luer lock adapter, DUO-VENT spike, 92"
2C8401s	Solution Set, Clearlink Y-Site (1 ea) with male luer lock, 76"
2C8419s	Solution Set, Clearlink Y-Site (1 ea) with male luer lock adapter, DUO-VENT spike, 92"
2C6519s	CONTINU-FLO Solution Set, Interlink Y-Site (2 ea) with luer lock adapter, backcheck valve <sup>2</sup> , 89"
2C6537s	CONTINU-FLO Solution Set, Interlink Y-Site (3 ea) with luer lock adapter, backcheck valve <sup>2</sup> , 110"
2C8515s	CONTINU-FLO Solution Set, Clearlink Y-Site (1 ea) with male luer lock, backcheck valve <sup>2</sup> , 106"
2C8519s	CONTINU-FLO Solution Set, Clearlink Y-Site (2 ea) with male luer lock, backcheck valve <sup>2</sup> , 112"
2C8537s	CONTINU-FLO Solution Set, Clearlink Y-Site (3 ea) with male luer lock, backcheck valve <sup>2</sup> , 110"
3C0062s	CONTINU-FLO Solution Set, Interlink Y-Site (4 ea) with 4-way large bore stopcock extension set, backcheck valve <sup>2, 7, 123</sup>
<b>Primary Set Minidrip (60 drops/mL)</b>	
2C6402s	Solution Set, Interlink Y-Site (1 ea) with luer lock adapter, lever lock cannula <sup>1</sup> , 76"
2C6424s	Solution Set, Interlink Y-Site (2 ea) with luer lock adapter <sup>1</sup> , 93"
2C8402s	Solution Set, Clearlink Y-Site (1 ea) with male luer lock <sup>1</sup> , 76"
2C6520s	CONTINU-FLO Solution Set, Interlink Y-Site (2 ea) with luer lock adapter, backcheck valve <sup>1, 2</sup> , 89"
2C6546s	CONTINU-FLO SOLUTION SET, INTERLINK Y-SITE (3 EA) WITH LUER LOCK ADAPTER, BACK-CHECK VALVE <sup>1, 2, 7, 106</sup> "

2C8546s CONTINU-FLO SOLUTION SET, CLEARLINK Y-SITE (3 EA) WITH MALE LUER LOCK, BACKCHECK VALVE<sup>1, 2, 7, 106</sup>"

**PRIMARY FILTER SET MACRO (10 DROPS/mL)**

2C6571s CONTINU-FLO SOLUTION SET, 0.22 MICRON FILTER, INTERLINK Y-SITE (2 EA) WITH LUER LOCK ADAPTER, BACKCHECK VALVE<sup>2, 3, 105</sup>"

2C8571s CONTINU-FLO SOLUTION SET, 0.22 MICRON FILTER, CLEARLINK Y-SITE (2 EA) WITH LUER LOCK ADAPTER, BACKCHECK VALVE<sup>2, 3, 105</sup>"

**PRIMARY FILTER SET MINIDRIP (60 DROPS/mL)**

2C6572s CONTINU-FLO SOLUTION SET, 0.22 MICRON FILTER, INTERLINK Y-SITE (2 EA) WITH LUER LOCK ADAPTER, BACKCHECK VALVE<sup>1, 2, 3, 105</sup>"

**BURETROL MINIDRIP (60 DROPS/mL)**

2C7519s 150 ML BURETTE, INTERLINK Y-SITE (2 EA) WITH LUER LOCK ADAPTER, BALL VALVE DRIP CHAMBER<sup>1, 4, 5, 117</sup>"

2C7562s 150 ML BURETTE, INTERLINK Y-SITE (3 EA) WITH VALVELESS BURETTE<sup>1, 4, 7, 115</sup>"

2C7564s 150 ML BURETTE, INTERLINK Y-SITE (2 EA) WITH DRIP CHAMBER FILTER VALVE, MALE LUER LOCK ADAPTER<sup>1, 4, 5, 7, 105</sup>"

2C8819s 150 ML BURETTE, CLEARLINK Y-SITE (2 EA) WITH LUER LOCK ADAPTER, BALL VALVE DRIP CHAMBER<sup>1, 4, 5, 117</sup>"

**Y-TYPE BLOOD SET (10 DROPS/mL)**

2C6750Hs BLOOD / SOLUTION SET, INTERLINK Y-SITE (1 EA) WITH LUER LOCK ADAPTER, (170 TO 260) MICRON FILTER<sup>3, 115</sup>"

2C8750s BLOOD/SOLUTION SET, CLEARLINK Y-SITE (1EA) WITH LUER LOCK ADAPTER<sup>3, 8, 112</sup>"

**NITROGLYCERIN SET (10 DROP/mL)**

1C8043s VENTED NITROGLYCERIN SET WITH LUER LOCK ADAPTER, 12" PVC PUMPING SEGMENT 6, 133"

**NITROGLYCERIN SET (60 DROP/mL)**

2C7551s VENTED NITROGLYCERIN SET, INTERLINK Y-SITE (1 EA) WITH LUER LOCK ADAPTER, 12" PVC PUMPING SEGMENT<sup>1, 6, 106</sup>"

2C8851s Vented Nitroglycerin Set, Clearlink Y-Site (1ea) with luer lock adapter, 11" PVC pumping segment<sup>1, 6, 105</sup>"

Buretrol, Clearlink, CONTINU-FLOW, and Interlink are all registered names / trademarks associated with Baxter International Inc.

## Compatible Baxter IV Sets – WARNINGS

The numbers reference the description listing table.



**WARNING:**

1. Minidrip chambers should not be used for flow rate settings greater than 200 mL/hr. Doing so may influence flow rate accuracy and cause nuisance upstream air or upstream occlusion alarms.
2. When using sets with backcheck valves flow rate settings should not exceed 500 mL/hr. Doing so may influence flow rate accuracy or cause nuisance upstream air or upstream occlusion alarms. Flow rates above 300 mL/hr may cause fluid to be siphoned from the primary container during piggyback operation.  
Failure to prime/remove all air bubbles from backcheck valves in primary sets may cause the valve to malfunction, resulting in secondary fluid flow back up into the primary container.
3. Partially occluded filters can cause nuisance upstream air, upstream occlusion or downstream alarms and influence flow rate accuracy.
4. Burettes with closed vents, or shutoff valves will cause upstream occlusions that may not be detected by the infusion pump.  
Rigid unvented containers used with unvented sets or vented sets with vent closed, will cause upstream occlusions that may not be detected by the infusion pump.
5. Ball Valve operation may not be detected as an alarm condition when using the SIGMA Spectrum Pump.
6. Rigid polyethylene lined tubing, as is often used in nitroglycerine sets, may produce as much as 10 PSI downstream occlusion pressure above the lower limit of the SIGMA Spectrum Pump specification.
7. Some Sets contain two or more slide clamps. Only the slide clamp on the pumping section or on the section with the main roller clamp should be used for pumping operation and clamp detection. Other slide clamps associated with the set need to be observed and controlled by the user.
8. Blood sets with both clamps closed above the blood filter will cause upstream occlusions conditions that may not be detected by the pump.  
See the Specification Section for Downstream Occlusion times and bolus release information.



**WARNING:**

Use the Specified Manufacturer's IV Set Type

This label is located on the top of the pump and indicates the specific type of IV tubing that the pump has been calibrated for. The use of other manufacturer's brands or type tubing could produce pump inaccuracies that could be unsafe for patients.

---



## Compatible Hospira IV Sets

The following is a partial listing of the Hospira IV sets compatible with the SIGMA Spectrum Pumps that have been calibrated for use with Hospira nominal size 0.100" I.D. Series IV set tubing. Please consult DOC 11181 for a full listing of compatible sets.

Sets must include a Green Slide Clamp or a Yellow Keyed Slide Clamp on the section of the set to be placed into the Spectrum Pump.

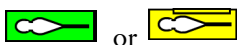

No.	Brief Description
<b>Primary Set Macro (15 Drops/mL)</b>	
11309-58	LS Primary Piggyback Set, PP backcheck valve, 2 PP Y-Sites, & OL <sup>2, 6, 7</sup> , 106"
11540-58	LS Primary Piggyback Set, PP backcheck valve, PP Y-site & OL <sup>2</sup> , 80"
11545-58	LS Primary Set, PP Y-site & OL, 78"
11679-65	LS Primary Piggyback Set with inline backcheck valve, 2 PP Y-sites, and OL <sup>2</sup> , 100"
11960-68	LS Convertible Pin I.V. Set, CLAVE Y-site and OL, 100"
11961-68	LS Primary Piggyback Set with inline backcheck valve, 2 CLAVE Y-sites & OL <sup>2</sup> , 100"
11965-68	LS Primary Piggyback Set, inline backcheck valve, 3 CLAVE Y-sites, and OL <sup>2</sup> , 7, 100"
12574-48	LS Primary Set, Convertible Pin & OL, 100"
20778-48	LS Primary Set with backcheck valve, Yellow Key Slide Clamp, 2 CLAVE Y-Sites, & OL <sup>2, 5</sup> , 100"
20793-48	LS Primary Set, Yellow Key Slide Clamp, with inline backcheck valve, 3 CLAVE Y-sites, 0.2 micron filter, & OL <sup>2</sup> , 3, 5, 6, 120"
20794-48	LS Primary Set, Yellow Key Slide Clamp, with inline backcheck valve, 3 CLAVE Y-sites, & OL <sup>2, 5, 6</sup> , 120"
20795-48	LS Primary Set, Yellow Key Slide Clamp, with inline backcheck valve, 3 CLAVE Y-sites, & OL <sup>2, 5</sup> , 120", w/Extension
20803-48	LS Primary Set, Yellow Key Slide Clamp, CLAVE Y-site & OL <sup>5</sup> , 100"
20815-48	LS Primary Set, Yellow Key Slide Clamp, with inline backcheck valve, 3 PP Y-Sites, & OL <sup>2, 5</sup> , 110"
<b>Primary Set Micro (60 Drops/mL)</b>	
11411-78	LS Microdrip Primary Piggyback Set, w/ backcheck valve, 2 PP Y-Sites, & OL <sup>1, 2, 6, 7</sup> , 100"
11539-78	LS Microdrip Primary Set, PP Y-site & OL <sup>1</sup> , 70"
11550-78	LS Microdrip Primary Piggyback Set, PP backcheck valve, PP Y-site Set OL <sup>1, 2</sup> , 80"
11962-78	LS Microdrip Piggyback Set, with inline backcheck valve, 2 CLAVE Y-sites & OL <sup>1, 2</sup> , 100"
12058-78	Microdrip Set with yellow striped tubing, CAIR Clamp & OL <sup>1</sup> , 112"
12426-48	LS Microdrip Piggyback Set with inline backcheck valve, 3 CLAVE Y-sites & OL <sup>1, 2, 7</sup> , 100"

- 12453-48 LS Microdrip Primary Set, 1 CLAVE Y-site & OL<sup>1</sup>, 100"
- 20779-48 LS Microdrip Primary Set with backcheck valve, Yellow Key Slide Clamp, 2 CLAVE Y-Sites, & OL<sup>1, 2, 5</sup>, 100"

**Primary Filter Set Micro (60 Drops/mL)**

- 20801-48 LS Primary Microdrip Filter Set with backcheck valve, Yellow Key Slide Clamp, 2 CLAVE Y-Sites, & OL<sup>1, 2, 3, 5</sup>, 100"

**Primary Filter Set Macro (15 Drops/mL)**

- 11538-68 LS Primary Piggyback Set, 0.2 micron filter, PP backcheck valve, PP Y-site & OL<sup>2, 3</sup>, 80"
- 11963-68 LS Primary Piggyback Set, with inline backcheck valve, 2 CLAVE Y-sites, 0.2 Micron High Pressure Filter & OL<sup>2, 3, 7</sup>, 100"
- 12573-48 LS Primary Set, 0.2 micron filter, specific pumping section, 1 CLAVE Y-Site & OL<sup>3, 6, 7</sup>, 110"
- 20780-48 LS Primary Set, 0.2 micron filter with backcheck valve, Yellow Key Slide Clamp, 2 CLAVE Y-Sites, & OL<sup>2, 3, 5</sup>, 100"

**150 mL Burette Set Macro (15 Drops/mL)**

- 12907-65 LS Burette Set, backcheck valve, 2 PP Y-Sites, 1 CLAVE Port, & OL<sup>2, 4, 7, 8</sup>, 106.5"
- 20797-48 LS Burette Set, Yellow Key Slide Clamp, 3 CLAVE Ports, & OL<sup>4, 5, 6</sup>, 120"
- 20798-01 LS Burette Set, Yellow Key Slide Clamp, 4 CLAVE Ports, & OL<sup>4, 5</sup>, 167", w/Extension

**150 mL Burette Set Micro (60 Drop/mL)**

- 11398-20 LS Microdrip Filter SoluSet 150 x 60, PP site on burette, capped port, PP Y-Site & OL<sup>1, 4, 7</sup>, 100"
- 11964-02 LS Filter SoluSet 150 x 60, slide clamp, 1 CLAVE Y-Site & OL<sup>1, 4, 7, 8</sup>, 77"
- 12341-01 LS Microdrip SoluSet 150 x 60, capped port, 1 CLAVE Y-Site & OL<sup>1, 4, 7</sup>, 77"
- 20804-01 LS Microdrip Burette Set, Yellow Key Slide Clamp, Filter Valve, Capped port, 1 CLAVE Y-Site & OL<sup>1, 3, 4, 5, 7</sup>, 110"

**Primary Nitroglycerin Set Macro (15 Drops/mL)**

- 11993-78 Nitroglycerin Primary Pump Set (not for gravity administration), specific pumping section with slide clamp 6, 110"

**Fat Emulsion Set Macro (15 Drops/mL)**

- 12060-58 Fat Emulsion Set, non-DEHP (except pump segment with connections), slide clamp on pump segment 6, 110"

**Y-Type Blood Set (10 drops/mL)**

- 11994-48 Y-Type Blood Set, 170 micron blood filter chamber, & OL<sup>3, 9</sup>, 105"
- 12450-48 LS HEMA Y-Type Blood Set, 1 CLAVE Y-Site, w/210 micron blood filter chamber, & Secure Lock3, 9, 100"
- 20796-48 LS Y-Type Blood Set, Yellow Key Slide Clamp, 1 CLAVE Y-Site, w/170 micron filter, & OL<sup>3, 5, 9</sup>, 110"
- 20805-48 LS Y-Type Blood Set, Yellow Key Slide Clamp, 1 CLAVE Y-Site, w/210 micron filter, & OL<sup>3, 5, 9</sup>, 100"
- 20806-48 LS Y-Type Blood Set, Yellow Key Slide Clamp, 1 CLAVE Y-Site, w/170 micron filter, & OL<sup>3, 5, 9</sup>, 100"

All sets use roller clamps referenced to as CAIR® clamp. All sets (except the Blood sets) use convertible pins.

LS = LifeShield®, OL = Option-Lok®, PP= Prepierced, CAIR®, CLAVE®, Option-Lok®, LifeShield®, Microdrip®, SoluSet® are all registered names / trademarks associated with Hospira (Abbott Laboratories).

## Compatible Hospira IV Sets – WARNINGS

The numbers reference the description listing table.



### WARNING:

1. Microdrip chambers should not be used for flow rate settings greater than 200 mL/hr. Doing so may influence flow rate accuracy and cause nuisance air or upstream occlusion alarms.
2. When using sets with backcheck valves, flow rate settings should not exceed 500 mL/hr. Doing so may influence flow rate accuracy or cause nuisance upstream air or upstream occlusion alarms. Flow rates above 300 mL/hr may cause fluid to be siphoned from the primary container during piggyback operation (see Secondary Infusion).  
Failure to prime/remove all air bubbles from backcheck valves in primary sets may cause the valve to malfunction, resulting in secondary fluid flow back up into the primary container.
3. Partially occluded filters can cause nuisance upstream air, upstream occlusion or downstream alarms and influence flow rate accuracy.
4. Burettes with closed vents, or shutoff valves will cause upstream occlusions that may not be detected by the infusion pump.  
Rigid unvented containers used with unvented sets or vented sets with vent closed, will cause upstream occlusions that may not be detected by the infusion pump.
5. Yellow Key Slide Clamp sets are only compatible with Spectrum software versions 4.02.06 or higher. Keyed for correct direction of flow.
6. Sets having a length that is greater than 48 inches from the exit of the pump to the patient connection end may have an increased downstream occlusion pressure, time to occlusion and bolus at occlusion release. For rates of less than 100 mL/hr, the pump should be set to the LOW downstream pressure setting.
7. Some IV sets contain two or more slide clamps. Only the slide clamp on the pumping section or on the section with the main roller clamp should be used for pumping operation and clamp detection. Other slide clamps associated with the set need to be observed and controlled by the user.
8. This set is configured with a roller clamp above the set slide clamp. When loading it into the Spectrum Pump ensure proper set orientation with slide clamp located above the pump.

9. Blood sets with both clamps closed above the blood filter will cause upstream occlusions conditions that may not be detected by the pump. See the Specification Section for Downstream Occlusion times and bolus release information.



**WARNING:** Use the Specified Manufacturer's IV Set Type

This label is located on the top of the pump and indicates the specific type of IV tubing that the pump has been calibrated for. The use of other manufacturer's brands or type tubing could produce pump inaccuracies that could be unsafe for patients.

---

## ACCESSORIES

### Tandem Carrier

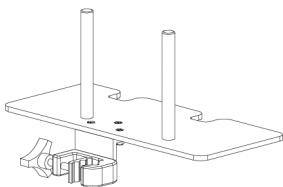

Cat No. 55092NS

- Holds 2 Spectrum Pumps
- Stainless upright tubes and aluminum plate
- C-clamp jaw opening expands to 1.5"
- C-clamp knob comes off if semi-permanent attachment of carrier is desired

### 3 Pump Carriers

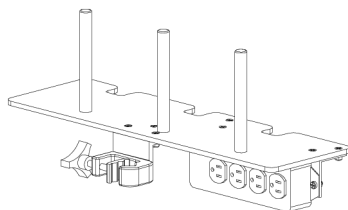

Cat No. 55093

- Holds 3 pumps.
- Stainless upright tubes and aluminum plate
- UL, CSA four outlet power strip for multi pole plug in (1 cord from IV pole to wall outlet)
- C-clamp jaw opening expands to 1.5"
- C-clamp knob comes off if semi-permanent attachment of carrier is desired

---

**CAUTION:** Use Stable IV Poles

Mount pumps on IV poles that securely hold the pump.

---

## Multi-Pole

Cat No. 55088-1

- Holds 5 pumps
- Adjustable height stainless steel pole
- 7-hook top
- UL, CSA six outlet power strip for multi-pole plug in (1 cord from IV pole to wall outlet)
- Heavy-duty 6-leg base with 3" soft rubber casters
- Patient support ring attached to rear of plate

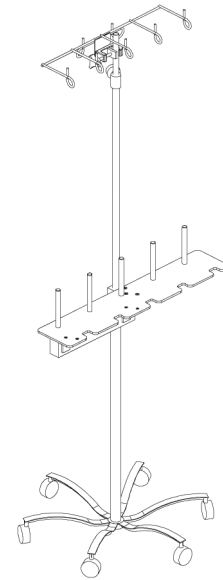

---

**CAUTION:** Securely mount IV pumps to pole by turning the mounting knob clockwise. To maintain IV pole stability never exceed 210 cm (83") from floor to IV pole top, and limit bag volume at this extended height to < 1 liter (1000 cc).

---

## AC Power Adaptor Protector

SIGMA Part Number (P/N) 45742

- Snaps on the adaptor side of AC Power Adaptor P/N 35714
- Handle on the Protector helps for easy insertion and removal of adaptor (power supply) from receptacle
- Protects adaptor from damage

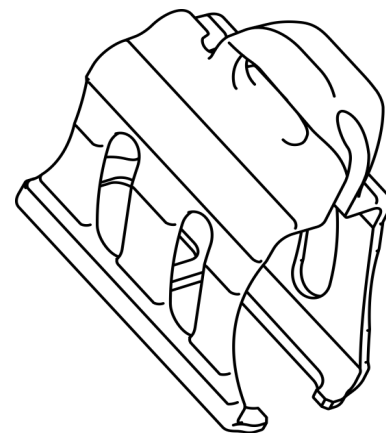

---

**CAUTION:** Always route IV set tubing and AC Power Adaptor cabling to prevent patient hazard or entanglement. Identify the individual IV set lines when multiple pumps and routes of administration are practiced.

---

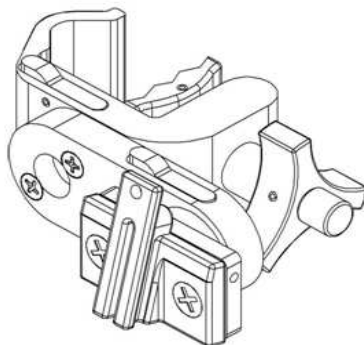

## Double Rotating Pole Clamp Assembly

SIGMA Part Number (P/N) 35743

- The double rotating feature of Double Rotating Pole Clamp enables the pump to be offset on left or right side of the single (standard) IV pole diameters ranging from 0.75" to 1.25".
- The clamp can also be clamped to hospital bedside rail diameters ranging from 0.75" to 1.25".
- Mount the clamp on the IV pole by rotating the triangular knob clockwise. The cylindrical protrusion on the triangular knob helps to rotate the knob faster.
- The pump mounted on the adaptor can be rotated clockwise or counterclockwise in 90° increments by pressing the lever located on the arm.
- The pump can be offset by the length of the arm by rotating the arm in clockwise or counterclockwise in 90° increments by pressing the lever located on the body of the clamp.
- Make sure the pump is in vertical orientation with the key hole at the top of the pump while in operation.
- Refer to the cleaning section of this manual for compatible cleaners.
- Refer to the installation manual, P/N 41092 on how to install the clamp on the pump.
- The weight of the clamp is less than 1.2 lbs.
- The dimension of the clamp is less than 7.0" long X 2.5" high X 4.5" wide.

---

**CAUTION:** Always operate the pump in vertical direction with the key hole at the top of the pump.

---

## APPENDIX A - SPECIFICATIONS

### Master Drug Library (MDL) Editor

- PC based, pharmacy edited and controlled, customized in-house list of all IV drugs and manuals, along with their safe delivery parameters
- Care Area enables:
  - same name/same concentration drugs to have different dose rate limits
  - pump configurations for maximum; rate, VTBI, patient weight and occlusion level
- Each drug entry includes, at a minimum, the care area, drug name, concentration, dose rate mode, bolus mode, starting dose rate, soft (able to be exceeded) and hard (not able to be exceeded; an optional setting) dose rate and bolus limits, volume to be infused (VTBI), primary or secondary IV container, and pump screen color.

### Drug Library Transfer

- Transfer via a wireless network connection to a pump using a Wireless Battery Module
- Transfer from the PC directly to a pump via IrDA®

### Standard Gravity IV Sets

Standard gravity IV sets from Baxter or Hospira.

### Standards

- IEC60601-1 including collateral standards; Third Party Notified Body Testing (Reference Electromagnetic Compatibility Tables)
- IrDA® Serial Infrared Physical Layer Link Specification v1.4(IrPHY), IrDA Serial Infrared Link Access Protocol v1.1 (IrLAP) and IrDA Serial Infrared Link Management Protocol v1.1 (IrLMP), IrDA Tiny TP v1.1
- Wireless – 802.11b, 802.11b/g
- EIA-RS-232 levels for Asynchronous Transmit/Receive only (RS232)



Specification	Description
AC Power	<p>AC Power Adaptor, low profile, covers only one outlet, Medical Grade (EN60601-1-2):</p> <ul style="list-style-type: none"> <li>■ Input: 100VAC - 240VAC, 50-60 Hz / 200 mA</li> <li>■ Output (P/N 35727): 9VDC/1200 mA, short circuit protected</li> <li>■ Output (P/N 35714): 9VDC/800 mA, short circuit protected</li> <li>■ cord length 3.0 m (~ 9.75 feet)</li> </ul> <p>Use only SIGMA part number 35727 or 35714.</p> <p>The SIGMA Spectrum Infusion Pump is classified according to Medical Electrical Equipment standards as:</p> <ul style="list-style-type: none"> <li>■ Class II Equipment</li> <li>■ Type BF Applied Part</li> <li>■ Continuous Operation</li> </ul>
AC Power Adaptor	Approximate Weight 10 oz
Alarm Volume	Variable (three levels: high, medium and low)
Alarms and Alerts	<ul style="list-style-type: none"> <li>■ Air-In-Line: dual beam ultrasonic detector alarms for large bubbles but allows smaller bubbles to pass. Detects air bubbles &gt; 1” (» 125µL Hospira, » 140µL Baxter), will alarm if &gt; 1 mL* of air in 15 min., &lt; 50µL bubbles are omitted in the summation of the 1 mL.*</li> <li style="padding-left: 20px;">*up to 1.5mL at 60°F</li> <li>■ Downstream Occlusion: automatic restart occurs after the downstream occlusion is cleared. Actuation can be set to Low, 6 ± 4 PSI, Medium, 13 ± 6 PSI or High, 19 ±9 PSI</li> <li>■ Very Low Battery - &lt;15 minutes of battery power remain</li> <li>■ Due for inspection: Preventative Maintenance and/or Network Certification</li> </ul>
Anti-Free-Flow System	Set based, utilizing IV set slide clamp.

Specification	Description
Battery Power and Capacity	<p>Standard Battery</p> <ul style="list-style-type: none"> <li>■ Lithium Ion, 1800 mA/h, 7.4 VDC nominal. SIGMA Part Number, 35724</li> <li>■ Capacity 8hrs (at 125 mL/hr at the highest backlight settings)</li> <li>■ 12 hr. recharge time</li> <li>■ Charging occurs if AC Power Adaptor is plugged in whether pump is ON or OFF</li> </ul> <p>Wireless Battery Module (802.11b)</p> <ul style="list-style-type: none"> <li>■ Lithium Ion, 1800 mA/h, 7.4 VDC nominal. SIGMA Part Number, 35083</li> <li>■ Capacity 4 hrs (at 125 mL/hr at the highest backlight settings)</li> <li>■ 16 hr. recharge time</li> <li>■ Charging occurs if AC Power Adaptor is plugged in, whether pump is ON or OFF</li> </ul> <p>Wireless Battery Module (802.11b/g)</p> <ul style="list-style-type: none"> <li>■ Lithium Ion, 1800 mA/h, 7.4 VDC nominal. SIGMA Part Number, 35162</li> <li>■ Capacity 4 hrs (at 125 mL/hr at the highest backlight settings).</li> <li>■ 16 hr. recharge time</li> <li>■ Charging occurs if AC Power Adaptor is plugged in, whether pump is ON or OFF</li> </ul>
Display	Color (16 out of a palette of 262,144 possible colors) HRTFT, 240 X 270, LED Front-Lit, 0.2235 mm X 0.2235 mm dot pitch
Dose Modes	mL/hr, mL/kg/min, mL/kg/hr, g/hr, mg/hr, mg/kg/hr, mg/min, mg/kg/min, mg/kg/day, mcg/hr, mg/kg/hr, mcg/min, mcg/kg/min, mcg/kg/day, ng/min, ng/kg/min, Units/hr, Units/kg/hr, Units/min, Units/kg/min, mUnits/min, mUnits/kg/hr, mUnits /kg/min, mEq/hr, mEq/kg/hr, mmol/hr, mmol/kg/hr
External Interfaces	IrDA (SIR Encoding Protocol. Supports IrOBEX). Additional Asynchronous Serial Port expansion bus available at battery terminals. Software upgrades may be performed through external RS-232.

Specification	Description
Flow Rate	0.5 to 999 mL/hr with 0.1 mL/hr increments from 0.5 to 99.9 mL/hr and 1.0 mL/hr increments from 100 to 999 mL/hr
Infusion Modes	Primary and Secondary, Multi-Step, and Cyclic TPN
KVO	At the completion of a primary infusion, the pump will infuse at the KVO rate configured per drug in the Drug Library or the current infusion rate, whichever is lower. The default KVO rate is set at 1 mL/hr but may be configured to between 0.5 - 50 mL/hr. At the completion of a secondary infusion program, the pump will run at a fixed KVO rate of 1 mL/hr.
Logging Memory	<ul style="list-style-type: none"> <li>■ AC Power Adaptor, low</li> <li>■ 24 hr memory of all set up screens except for multi-step and cyclic modes that are maintained permanently</li> <li>■ Separate pump history log and drug event log</li> <li>■ 10,000 ± event capacity. Once the maximum number of log entries is reached, the data for each new event replaces the data for the oldest event (the data for oldest event is lost)</li> </ul>
Maximum Pump Pressure	28 PSI
Occlusion Pressure	Adjustable: High (19 ±9 PSI), Medium (13 ±6 PSI), and Low (6 ±4 PSI)
Operational Conditions	<p>With Standard Battery</p> <ul style="list-style-type: none"> <li>■ Operating temperature: 60 to 90°F (15.6 to 32.2° C), 20 to 90% relative humidity non-condensing</li> </ul> <p>With Wireless Battery Module</p> <ul style="list-style-type: none"> <li>■ Operating temperature: 60 to 80°F (15.6 to 26.7° C), 20 to 90% relative humidity non-condensing</li> </ul>
Overall Size (Pump)	<p>With Standard Battery</p> <ul style="list-style-type: none"> <li>■ Without IV pole clamp – 5.8” H x 4.2” W x 2.5” D</li> <li>■ With IV pole clamp – 5.8” H x 6.4” W x 4.7” D</li> </ul> <p>With Wireless Battery Module</p> <ul style="list-style-type: none"> <li>■ Without IV pole clamp – 6.3” H x 4.2” W x 2.5” D</li> <li>■ With IV pole clamp – 6.3” H x 6.4” W x 4.7” D</li> </ul>
Pumping Mechanism	Linear peristaltic

Specification	Description												
Storage Temperature	<p>With Standard Battery</p> <ul style="list-style-type: none"> <li>■ Storage temperature: -4 to 120°F (-20 to 49°C), 10 to 90% relative humidity non-condensing</li> </ul> <p>With Wireless Battery Module</p> <ul style="list-style-type: none"> <li>■ Storage temperature: -4 to 120°F (-20 to 49°C), 10 to 90% relative humidity non-condensing</li> </ul>												
Timekeeping	<p>Real Time Clock, battery backed, 10-year life</p> <p><i>NOTE:</i> Clock is set to GMT.</p>												
Total Drug Delivered	<p>0.1 to 9999 mL with 0.1 mL increments from 0.1 to 99.9 mL and 1.0 mL increments from 100 to 9999 mL</p>												
Volumetric Accuracy	<p>Accuracy is based on volume collected over one hour using compatible Baxter and Hospira Standard IV Sets.</p> <table border="1" data-bbox="636 884 1328 1140"> <thead> <tr> <th></th> <th>BAXTER</th> <th>HOSPIRA</th> </tr> </thead> <tbody> <tr> <td>0.5 – 1.9 mL/hr</td> <td>±0.1mL/hr</td> <td>±0.1mL/hr</td> </tr> <tr> <td>2.0 – 800 mL/hr</td> <td>±5%</td> <td>±5%</td> </tr> <tr> <td>801 – 999 mL/hr</td> <td>±5%</td> <td>±10%</td> </tr> </tbody> </table> <p>Specified accuracy is maintained on Baxter Standard IV Sets for up to 96 hours (maximum 12 liters) and on Hospira Standard IV Sets for up to 72 hours (maximum 9 liters)</p>		BAXTER	HOSPIRA	0.5 – 1.9 mL/hr	±0.1mL/hr	±0.1mL/hr	2.0 – 800 mL/hr	±5%	±5%	801 – 999 mL/hr	±5%	±10%
	BAXTER	HOSPIRA											
0.5 – 1.9 mL/hr	±0.1mL/hr	±0.1mL/hr											
2.0 – 800 mL/hr	±5%	±5%											
801 – 999 mL/hr	±5%	±10%											
Weight	<p>With Standard Battery</p> <ul style="list-style-type: none"> <li>■ Without IV pole clamp – 25.5 oz ± 1.0 oz</li> <li>■ With IV pole clamp – 33.5 oz ± 1.0 oz</li> </ul> <p>With Wireless Battery Module</p> <ul style="list-style-type: none"> <li>■ Without IV pole clamp – 26.5 oz ± 1.0 oz</li> <li>■ With IV pole clamp – 34.5 oz ± 1.0 oz</li> </ul>												

Specification	Description
Wireless Network Interface	<p>Wireless Battery Module (802.11b), SIGMA Part Number 35083</p> <ul style="list-style-type: none"> <li>■ Standard: IEEE 802.11b</li> <li>■ Transmit power: 16 dBm typical</li> </ul> <p>Wireless Battery Module (802.11b/g), SIGMA Part Number 35162</p> <ul style="list-style-type: none"> <li>■ Standard: IEEE 802.11b/g</li> <li>■ Transmit Power: 12 dBm typical</li> </ul>
Wireless Security	<p>WEP (Wired Equivalent Privacy)</p> <ul style="list-style-type: none"> <li>■ Encryption: 64/128-bit (RC4)</li> </ul> <p>WPA/WPA2/802.11i</p> <ul style="list-style-type: none"> <li>■ Encryption: TKIP, CCMP (AES)</li> <li>■ WPA-PSK</li> <li>■ 802.1X authentication</li> <li>■ LEAP (WEP only)</li> <li>■ PEAP/MSCHAPv2</li> <li>■ EAP-TLS</li> </ul>

## APPENDIX B - FLOW RATE ACCURACY

### Effect of Fluid Container Height <sup>1 2</sup>

The performance of the infusion pump will be influenced by the forces of gravity on the fluid being administered to the patient. When a fluid container is positioned above or below the patient's administration site, pressure forces associated with the fluid's head-height (distance measured from the center of the pumping mechanism to the top of the fluid in the source container) will cause deviations in the nominal specification for device flow rate accuracy. The nominal head-height used for the flow rate specification is 24" (61 cm).

### Effect of Back Pressure

Positive back pressure can influence the flow rate accuracy of the infusion. Back pressure equivalent to 300 mmHg may reduce the flow rate causing a deviation in accuracy by -9%. Negative back pressure of -100 mmHg may increase flow rate causing a deviation in accuracy of 7% Hospira and 3% Baxter IV Sets.

### Flow Profile

The SIGMA Spectrum Infusion pump has the following start-up flow rate accuracy curve shape associated with stability through time. These graphs represent the variation in flow rate that is recorded from the time the infusion is started to the end of a two hour period. The graph is intended to give a picture of the "general stability" with time of the infusion. The graph is commonly called a "start-up curve". The techniques and methods of test and generation of this graph are as detailed in IEC 60601-2-24, *Medical electrical equipment – Part 2-24: Particular requirements for the safety of infusion pumps and controllers*.

---

#### CAUTION: Accuracy

Refer to trumpet curves for flow rate accuracy as a function of short infusion durations.

The upstream occlusion detector may not detect partially occluded tubing. Always check to ensure the IV set's clamp is not closed above the Spectrum Pump and respond appropriately to all primary and secondary check flow prompts.

Small bore catheters or needles may cause excessive back pressure at high flow rates. Size the catheters according to expected flow rate and fluid viscosity.

---

---

1. REFERENCE: AAMI ID26:1998, SUB-CLAUSE 50.102  
2. LIQUID CONTAINER MUST BE VENTED OR A COLLAPSIBLE BAG

Startup Graph, First Two Hours  
Set Rate 25 mL/hr

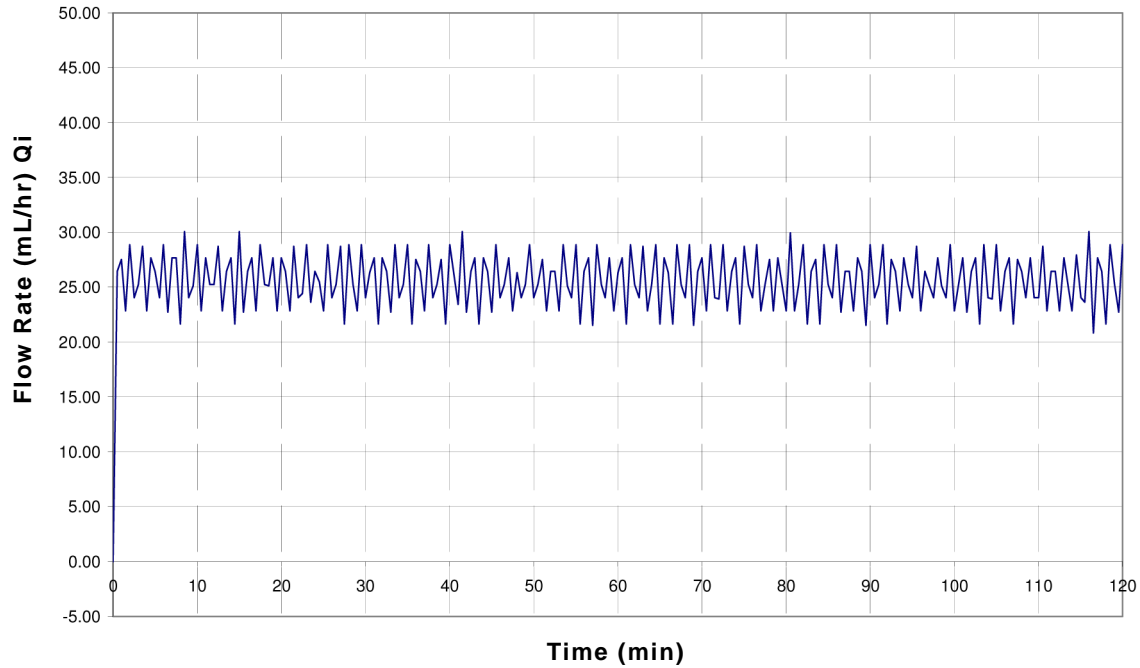

The percent variation of mean flow rate accuracy over a specific observation period may be quantified with the use of a trumpet graph. Using the rationale for development of a statistical trumpet graph as defined in IEC 60601-2-24, a presentation of the SIGMA Spectrum mean flow over a specific measurement interval is provided.

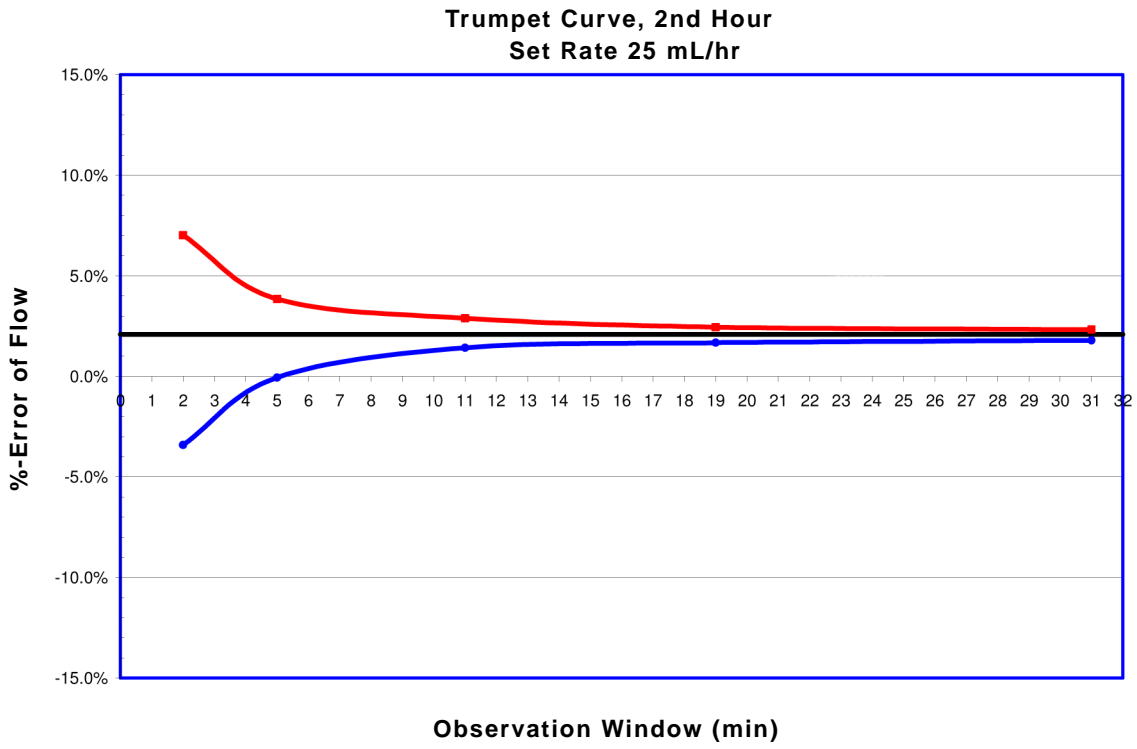



Flow Rate Graph, Last Hour  
Set Rate 25 mL/hr

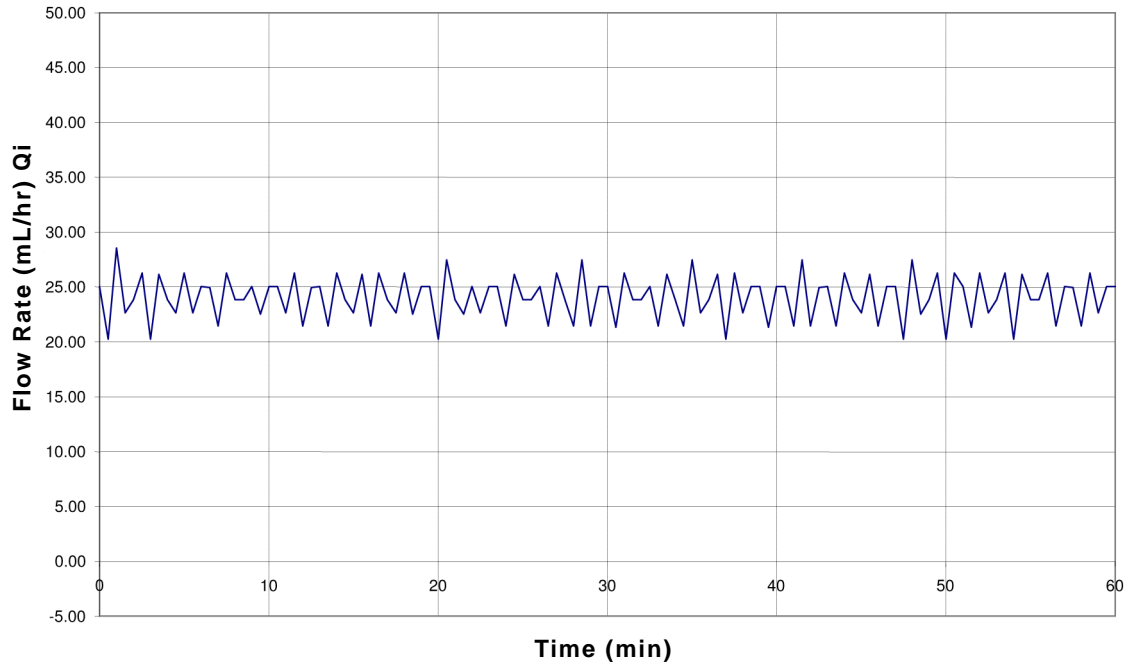

Typical of intermediate rate last\* Hr Flow Accuracy

Trumpet Curve, Last Hour  
Set Rate 25 mL/hr

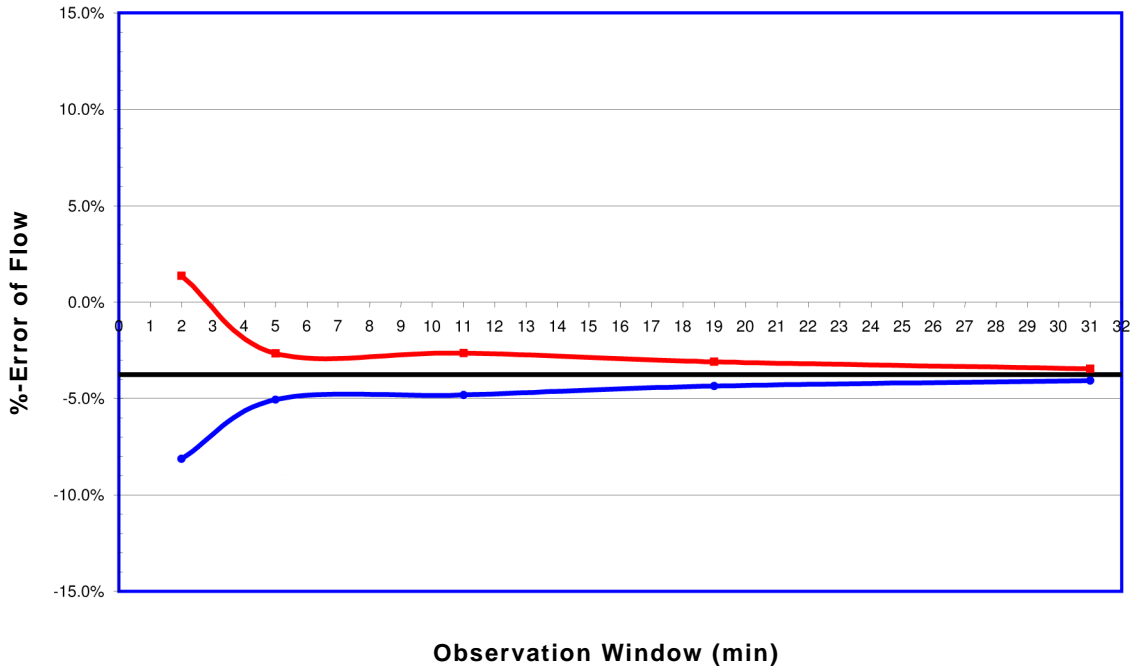

Typical of intermediate rate last\* Hr, Trumpet Graph

*NOTE:* For Hospira calibration the last hour is the 72nd hour. For Baxter calibration the last hour is the 96th hour.

**It is important for the clinician to understand the pharmacological influence of specific drugs based on concentrations and patient response when used in conjunction with the SIGMA Spectrum.**

Pumping mechanisms produce fluctuation in fluid flow by design based on the specific mechanism type (peristaltic, piston, rotary, etc.), electronic control system and other factors related to the administration set's characteristics. Specific flow profiles are helpful in determining the correct clinical application for the infusion pump. Data is presented as requested by the applicable standards and represents the typical flow rate function of the Spectrum Pump for short and long term operation. To help with the visualization of the flow inconsistencies that are typical of most infusion pumps, the start-up graphs and trumpet curves are extended to include the minimum rate (.5mL/hr) and intermediate rate (25 mL/hr) for the SIGMA Spectrum.

*NOTE:* The SIGMA Spectrum is best classified as a "Volumetric Infusion Pump" as defined by the applicable standards. Reference IEC 60601-2-24 and AAMI ID26:1998, Medical electrical equipment – Part 2: Particular requirements for safety of infusion pumps and controllers.

Startup Graph, First Two Hours  
Set Rate .5 mL/hr

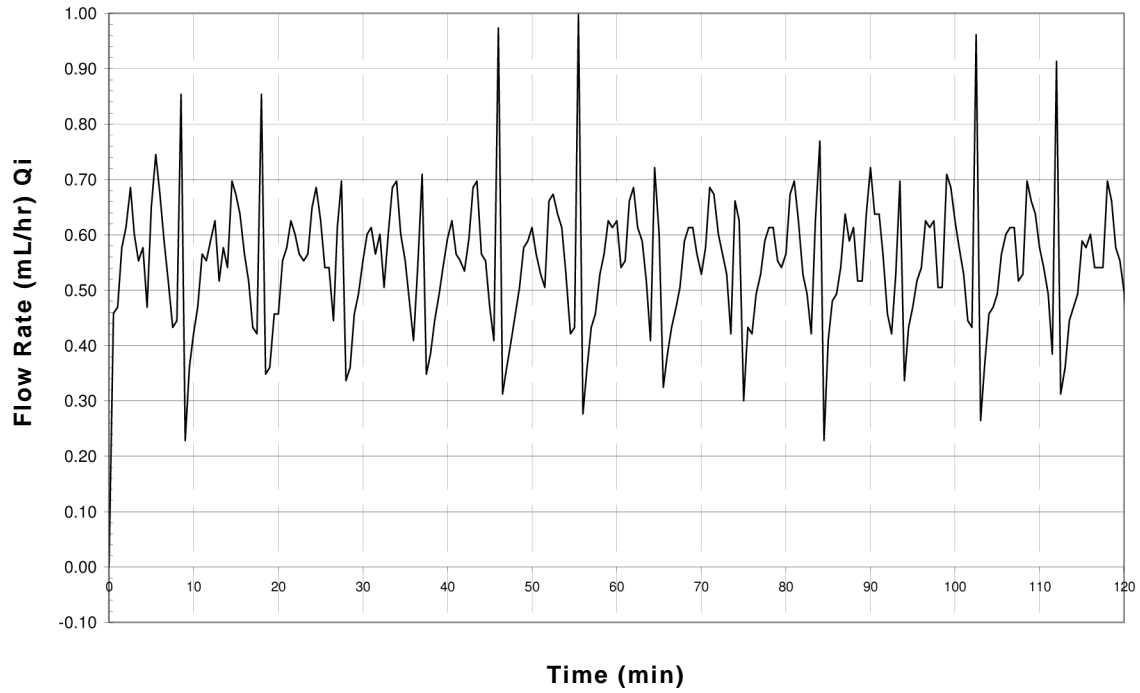

Typical of minimum rate start-up, flow rate

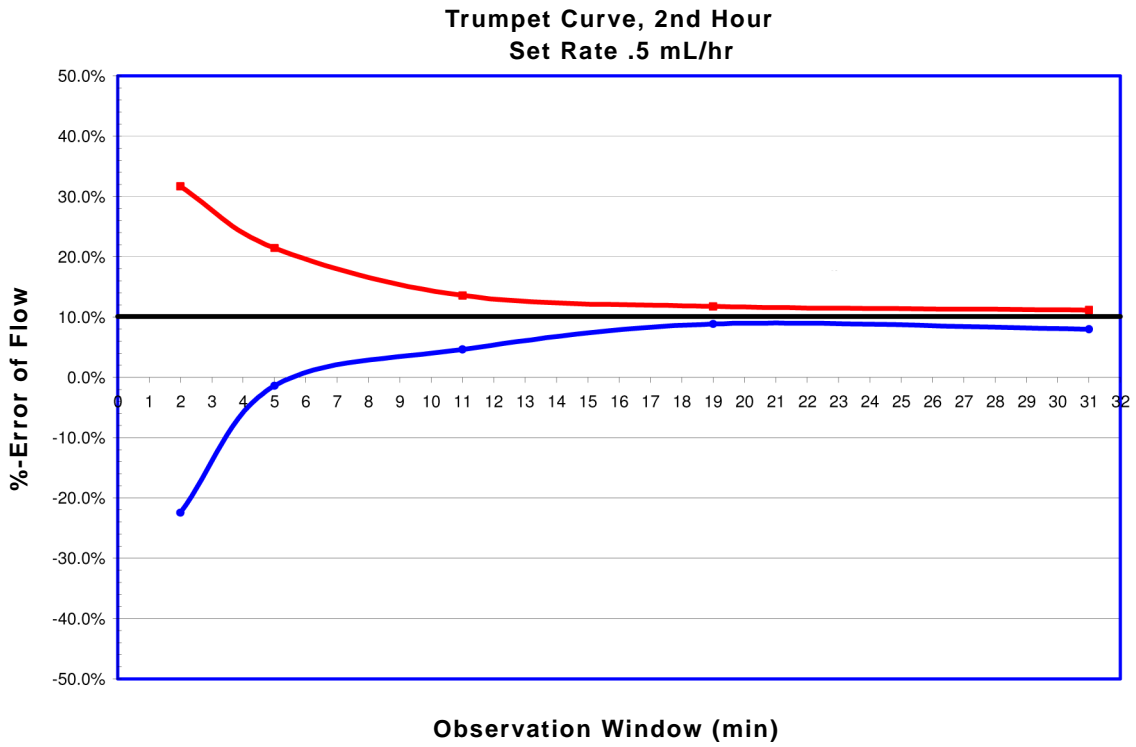

Typical of minimum rate 2nd Hr, Trumpet Graph

Flow Rate Graph, Last Hour  
Set Rate .5 mL/hr

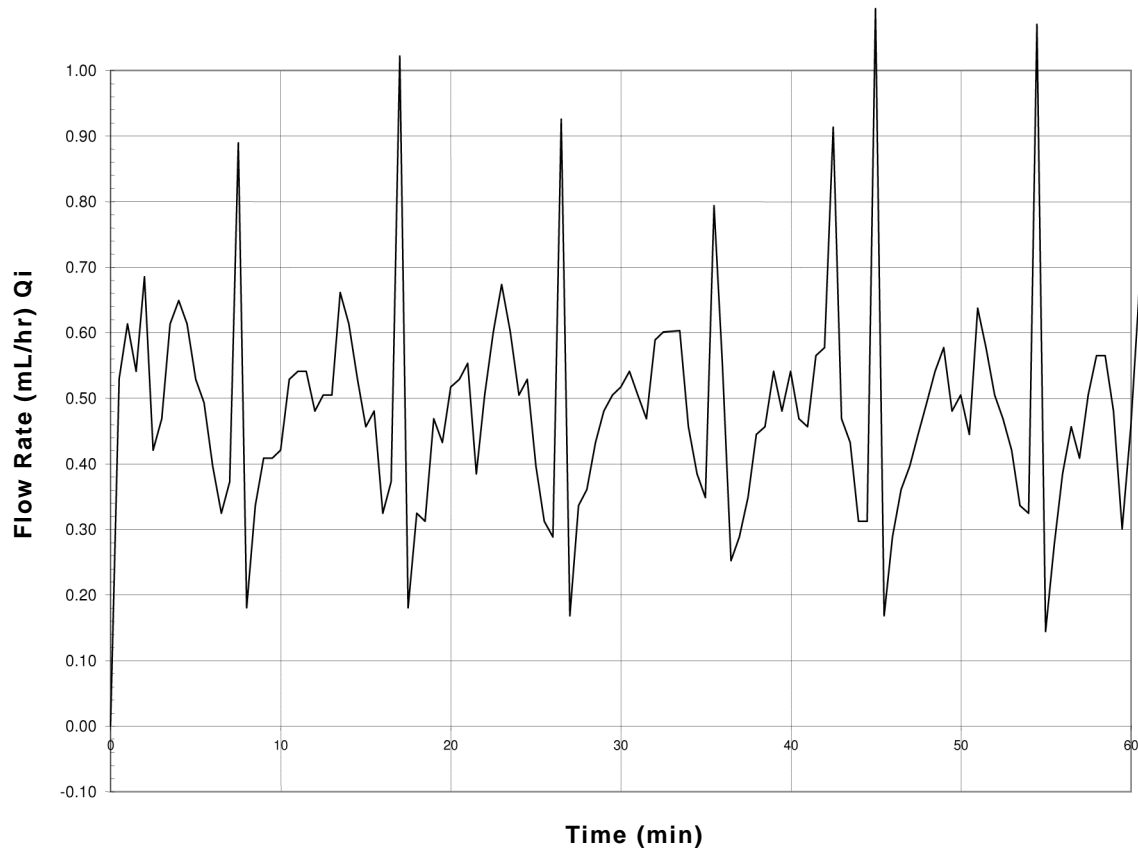

Typical of minimum rate last\* Hr Flow Accuracy

Trumpet Curve, Last Hour  
Set Rate .5 mL/hr

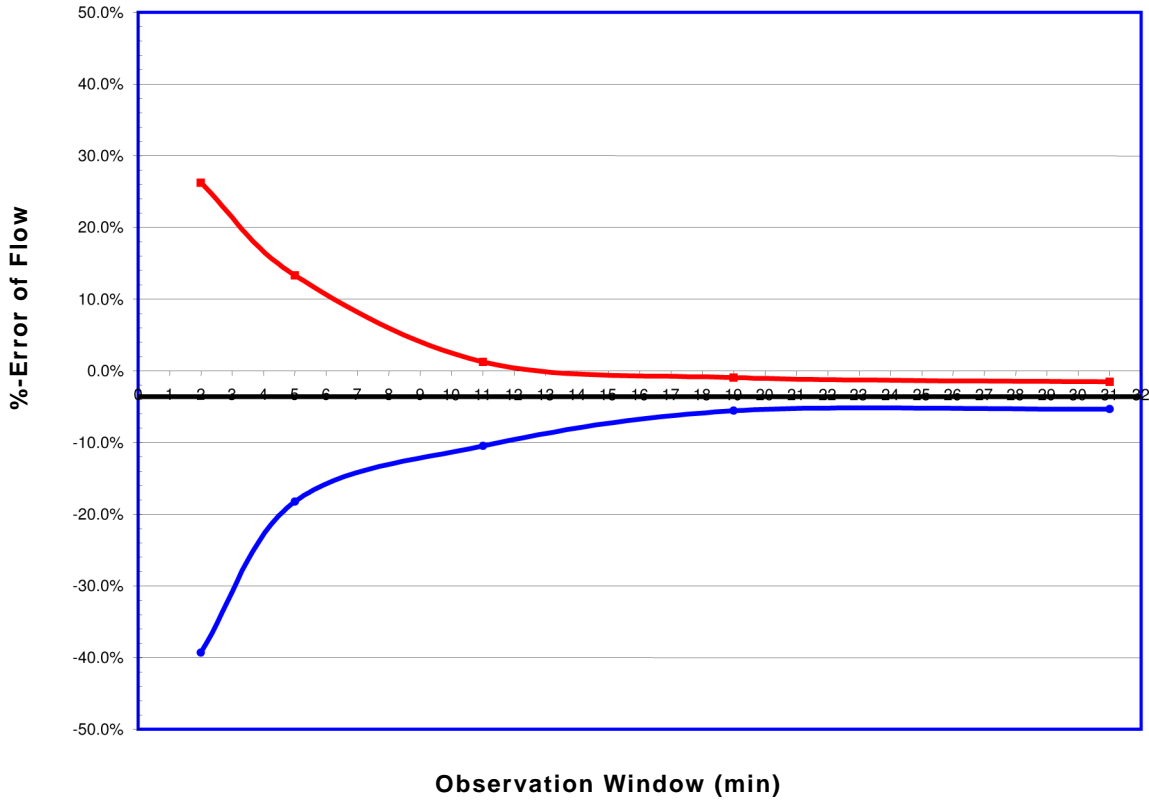

Typical of minimum rate last\* Hr, Trumpet

NOTE: For Hospira calibration the last hour is the 72nd hour.  
For Baxter calibration the last hour is the 96th hour.

## APPENDIX C - BOLUS ACCURACY

The SIGMA Spectrum IV Pump may have an optional bolus mode of operation. This feature allows the user to perform a BOLUS SETUP action. To utilize this feature the pump must be programmed with either a specific rate or a specific amount to be delivered in a certain amount of time.

If the pump is currently operating in mL/hr delivery mode, the bolus rate value is entered in mL/hr and the volume is entered in milliliter (mL). If the pump is operating in a non-mL/hr delivery mode (for example mcg/kg/min), the bolus amount would be entered in mcg/kg however the mL/HR soft-key may be pressed in the setup screen to enter the bolus information in mL/hr format.

In either mode, the time is entered in minutes and seconds (min:sec). Limits are placed on the minimum and maximum amount of time for the bolus delivery. The limit constraints are contained within the software of the Spectrum Pump and are necessary to control the maximum or minimum flow rate of the bolus infusion.

The accuracy of the bolus volume is dependent on the resultant flow rate that is obtained from the calculation of volume to be delivered in the time requested. For example if the maximum bolus volume is 300 mL, the maximum flow rate is obtained with a bolus time of 18:01 (min:sec) or a flow rate of approximately 999 mL/hr. Using this maximum bolus volume, and delivering the volume in the shortest amount of time, the mean value of 300 mL  $\pm$  5% may be expected. Where as using a minimum bolus volume (0.5 mL), and delivering the volume in a short amount of time (1 minute), the mean value of 0.5 mL  $\pm$  16% may be expected.

## APPENDIX D - DOWNSTREAM OCCLUSION

### Time to Occlusion

The maximum time for activation of the downstream occlusion alarm at the minimum flow rate of 0.5 mL/hr is 1 hour at the minimum occlusion threshold setting. It is 3 hours at the maximum occlusion alarm threshold setting.

The maximum time for activation of the downstream occlusion alarm at the intermediate flow rate of 25 mL/hr is 50 seconds at the minimum occlusion threshold setting. It is three minutes at the maximum occlusion alarm threshold setting.

### Bolus Volume

The maximum bolus volume generated as a result of operation at 25 mL/hr and reaching the minimum downstream occlusion alarm threshold is 0.25 mL.

The maximum bolus volume generated as a result of operation at 25 mL/hr and reaching the maximum downstream occlusion alarm threshold is 0.8 mL.

---

**CAUTION:** Specifications for Downstream Occlusion detection times and bolus volume, after release of occlusion, are based on specific test conditions. The analytical related conditions are:

- A distance of 48” from the point of the downstream occlusion to the SIGMA Spectrum’s Downstream Occlusion sensor (approximately the distance from the IV administration set’s exit from the pumping channel to the point of occlusion).
- The 48” test administration set contained one “y”-site (no filters, or other components).
- Testing was at the nominal room temperature (72°F ±2°F).

Time to Downstream Occlusion and Bolus Volume release will generally increase under the following conditions: longer distances to the occlusion point, additional fluid volumetric area (from filters or other components within the IV set length) and hotter room temperatures.

---



# APPENDIX E - ELECTROMAGNETIC COMPATIBILITY

## Emissions



**WARNING:** The use of accessories or cables other than those specified by SIGMA may result in increased Emissions or decreased Immunity of this medical device.

**CAUTION:** Be Cautious Near RF Sources

The Spectrum Pump meets the electromagnetic compatibility (EMC) requirements as specified in the International Electrotechnical Commission's (IEC) 60601-1-2 (2001-09) standard for emissions and immunity. It is good practice to keep the pump separated away from other equipment, such as hand-held transmitters, cellular phones and electrosurgical equipment that may generate strong radio frequency interference (RFI). Refer to the EMC Immunity Section, Separation Distance, in this manual for recommended minimum distance.

Guidance and manufacturer's declaration – electromagnetic emissions		
The SIGMA Model Spectrum Infusion pump is intended for use in the electromagnetic environment specified below. The customer or user of the Spectrum should assure that it is used in such an environment.		
Emissions test	Compliance	Electromagnetic environment - guidance
RF emissions CISPR 11	Group 1	The Spectrum is suitable for use in all establishments, including domestic establishments and those directly connected to the public low-voltage power supply network that supplies buildings used for domestic purposes.
RF emissions CISPR 11	Class B	
Harmonic emissions IEC 61000-3-2	Class A	
Voltage fluctuations/ flicker emissions IEC 61000-3-3	Complies	

## Immunity – ESD, transient/burst, voltage disparity, magnetic

<b>Guidance and manufacturer’s declaration – electromagnetic immunity</b>			
The SIGMA Model Spectrum Infusion pump is intended for use in the electromagnetic environment specified below. The customer or user of the Spectrum should assure that it is used in such an environment.			
<b>Immunity test</b>	<b>IEC 60601 test level</b>	<b>Compliance level</b>	<b>Electromagnetic environment - guidance</b>
Electrostatic discharge (ESD) IEC 61000-4-2	±8 kV contact ± 15 kV air	±2 kV contact ± 15 kV air	Floors should be wood, concrete or ceramic tile. If floors are covered with synthetic material, the relative humidity should be at least 30%. See Note 1.
Electrical fast transient/burst IEC 61000-4-4	± 2 kV for power supply lines ±1 kV for input/output lines	± 2 kV for power supply lines Not applicable	Supply power quality should be that of a typical commercial or hospital environment.
Surge IEC 61000-4-5	±1 kV differential mode ±2 kV common mode	±1 kV differential mode Not applicable	Supply power quality should be that of a typical commercial or hospital environment.
Voltage dips, short interruptions and voltage variations on power supply input lines IEC 61000-4-11	<5 % 120 VAC (>95 % dip in 120 VAC) or 0.5 cycle  40 % 120 VAC (60 % dip in 120 VAC) for 5 cycles  70 % 120 VAC (30 % dip in 120 VAC) for 25 cycles  <5 % 120 VAC (>95 % dip in 120 VAC) for 5 sec	<5 % 120 VAC (>95 % dip in 120 VAC) or 0.5 cycle  40 % 120 VAC (60 % dip in 120 VAC) for 5 cycles  70 % 120 VAC (30 % dip in 120 VAC) for 25 cycles  <5 % 120 VAC (>95 % dip in 120 VAC) for 5 sec	Supply power quality should be that of a typical commercial or hospital environment. If the user of the Spectrum requires continued operation during power interruption, it is recommended that the Spectrum be powered from an uninterrupted power supply or the internal battery be fully charged to provide unit power as specified in this operator’s manual.
Power frequency (50/60 Hz) magnetic field IEC 61000-4-8	400 A/m	400 A/m	Power frequency magnetic fields should be at levels characteristic of a typical commercial or hospital environment.

Note1: For levels 2, 3 & 4 a clearable alarm will occur with interruption of flow.



**WARNING:** The Spectrum Pump is not designed to be MRI-compatible nor is it intended to be used in this manner. Strong magnetic fields (those beyond the level tested) may cause the device to operate improperly.

Do not expose the SIGMA Spectrum to strong magnetic fields such as is common with MRI equipment. Doing so may cause injury to the patient and/or damage to the equipment.

---

### Immunity – Conducted and Radiated

Guidance and manufacturer's declaration – electromagnetic immunity			
The SIGMA Model Spectrum Infusion pump is intended for use in the electromagnetic environment specified below. The customer or user of the Spectrum should assure that it is used in such an environment.			
Immunity test	IEC 60601 test level	Compliance level	Electromagnetic environment - guidance
Conducted RF IEC 61000-4-6	3 Vrms 150 kHz to 80 MHz in ISM bands a	3 Vrms	<p>Portable and mobile RF communications equipment should be used no closer to any part of the Spectrum, including cables, than the recommended separation distance calculated from the equation applicable to the frequency of the transmitter.</p> <p><b>Recommended separation distance</b></p> <p><math>d = 1.2\sqrt{P}</math></p> <p><math>d = 1.2\sqrt{P}</math></p> <p><math>d = 1.2\sqrt{P}</math> 80 MHz to 800 MHz</p> <p><math>d = 2.3\sqrt{P}</math> 800 MHz to 2.5 GHz</p> <p>Where <math>P</math> is the maximum output power rating of the transmitter in watts (W) according to the transmitter manufacturer and <math>d</math> is the recommended separation distance in meters (m).<sup>b</sup></p> <p>Field strengths from fixed RF transmitters, as determined by an electromagnetic site survey, <sup>c</sup> should be less than the compliance level in each frequency range. <sup>d</sup></p> <p>Interference may occur in the vicinity of the equipment marked with the following symbol: : “This excludes the Wireless Battery Modules, SIGMA Part Number 35083 and 35162”</p> 
	10 Vrms 150 kHz to 80 MHz in ISM bands a	10 Vrms	
Radiated RF IEC 61000-4-3	10 V/m 80 MHz to 2.5 GHz	10 V/m	

Note 1 At 80 MHz and 800 MHz, the higher frequency range applies.

Note 2 These guidelines may not apply in all situations. Electromagnetic propagation is affected by absorption and reflection from structures, objects and people.

<sup>a</sup> The ISM (industrial, scientific, and medical) bands between 150 kHz and 80 MHz are 6.756 MHz to 6.795 MHz; 13.553 MHz to 13.567 MHz; 26.957 MHz to 27.283 MHz; and 40.66 MHz to 40.70 MHz.

<sup>b</sup> The ISM compliance level in the ISM frequency band between 150 kHz and 80 MHz and in the frequency range 80 MHz to 2.5 GHz are intended to decrease the likelihood that mobile/portable communications equipment could cause interference if it is inadvertently brought into patient areas. For this reason an additional factor of 3K is used in calculating the recommended separation distance for transmitters in these frequency ranges.

<sup>c</sup> Field strength from fixed transmitters, such as base stations for radio (cellular/cordless) telephones and land mobile radio, amateur radio, AM and FM radio broadcast and TV broadcast cannot be predicted theoretically with accuracy. To assess the electromagnetic environment due to fixed RF transmitters, an electromagnetic site survey should be considered. If the measured field strength in the location in which the Spectrum is used exceeds the applicable RF compliance level above, the Spectrum should be observed to verify normal operation. If abnormal performance is observed, additional measures may be necessary, such as reorienting or relocating the Spectrum.

<sup>d</sup> Over the frequency range 150 kHz to 80 MHz, field strength should be less than 3 V/m.

## Immunity – Separation Distances

Recommended separation distance between portable and mobile RF communications equipment and the Spectrum				
The SIGMA Model Spectrum is intended for use in an electromagnetic environment in which the RD disturbances are controlled. The customer or user of the Spectrum can help prevent electromagnetic interference by maintaining a minimum distance between the portable and mobile RF communications equipment (transmitters) and the Spectrum as recommended below, according to the maximum output power of the communications equipment.				
Rated maximum output power of transmitter W	Separation distance according to frequency of transmitter m			
	150 kHz to 80 MHz outside ISM bands  $d = 1.2\sqrt{P}$	150 kHz to 80 MHz in ISM bands  $d = 1.2\sqrt{P}$	80 MHz to 800 MHz  $d = 1.2\sqrt{P}$	800 MHz to 2.5 GHz  $d = 2.3\sqrt{P}$
0.01	0.12	0.12	0.12	.23
0.1	0.38	0.38	0.38	.73
1	1.2	1.2	1.2	2.3
10	3.8	3.8	3.8	7.3
100	12	12	12	23

For transmitters rated at maximum output power not listed above, the recommended separation distance  $d$  in meters (m) can be determined using the equation applicable to the frequency of the transmitter, where power  $P$  is the maximum output power rating of the transmitter in watts (W) according to the transmitter manufacturer.

NOTE 1 At 80 MHz and 800 MHz, the separation distance for the higher frequency range applies.

NOTE 2 The ISM (industrial, scientific, and medical) bands between 150 kHz and 80 MHz are 6.756 MHz to 6.795 MHz; 13.553 MHz to 13.567 MHz; 26.957 MHz to 27.283 MHz; and 40.66 MHz to 40.70 MHz.

NOTE 3 An additional factor of 10/3 is used in calculating the recommended separation distance for the transmitters in the ISM frequency band between 150 kHz and 80 MHz and in the frequency range 80 MHz to 2.5 GHz to decrease the likelihood that mobile/portable communications equipment could cause interference if it is inadvertently brought into patient areas.

NOTE 4 The guidelines may not apply in all situations. Electromagnetic propagation is affected by absorption and reflection from structures, objects and people.



**WARNING:**

The Spectrum Pump is not designed to be exposed to linear accelerator radiation nor is it intended to be used in this manner. Exposure to radiation of this type may cause the device to operate improperly.

Do not expose the SIGMA Spectrum to linear accelerator radiation. Doing so may cause injury to the patient and/or damage to the equipment.

## APPENDIX F - LOW / VERY LOW BATTERY TUTORIAL

The Low Battery and Very Low Battery Tutorials provide step-by-step confirmation that the external power supply is connected to the wall outlet, the power light is illuminated, and the power cord is properly connected to the Spectrum.

### Low Battery Tutorial

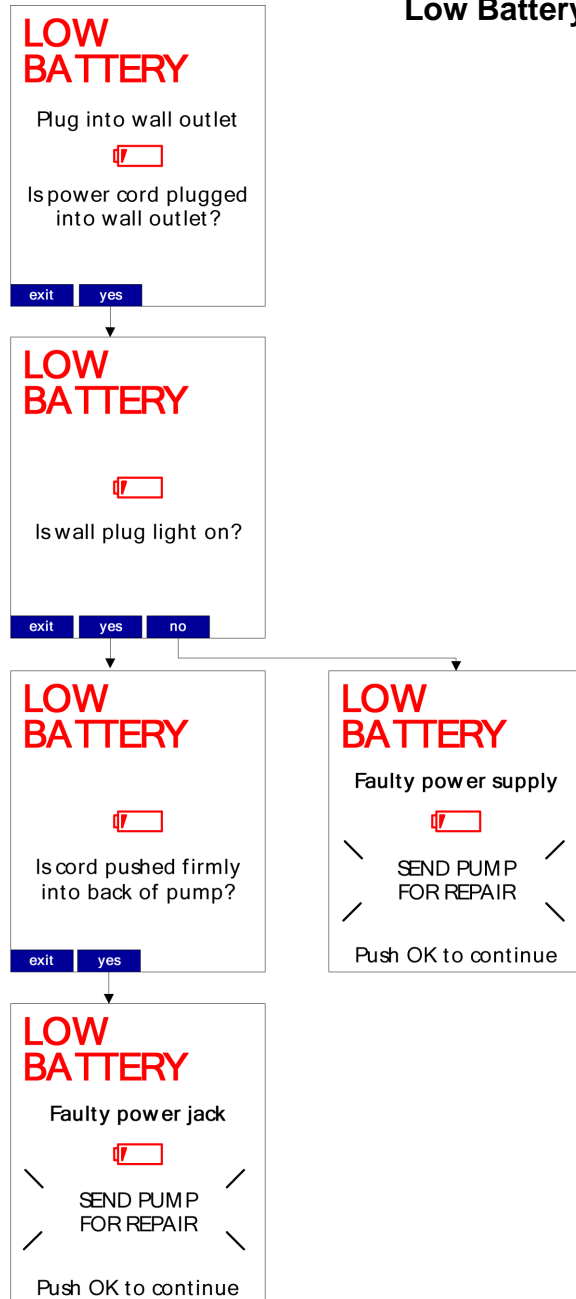

## Very Low Battery Tutorial

When the Very Low Battery Alarm activates, the following tutorial appears.

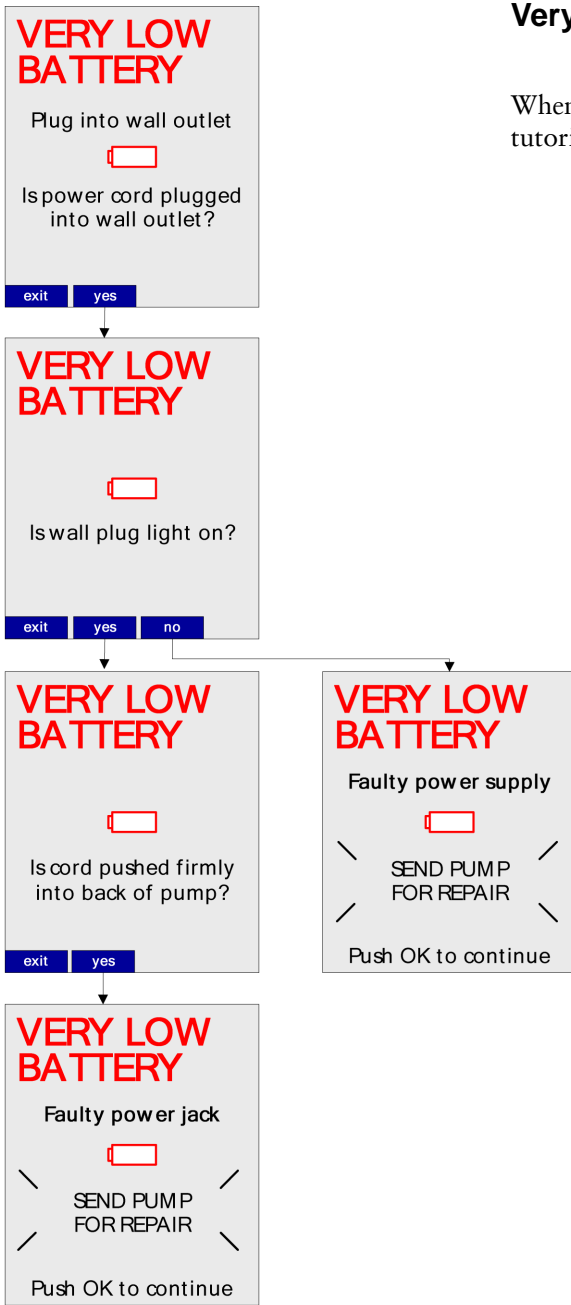



## APPENDIX G - ICONS

### Power Icons

These icons are visible in the upper left corner of the pump display.



Battery is low or very low (red battery)



Battery is 25% charged



Battery is 50% charged



Battery is 75% charged



Battery is 100% charged



Battery is installed and the AC adaptor is connected. Alternates with one of the battery levels above, on pumps with Wireless Battery Module.



Battery is depleted or missing (red battery)



AC adaptor is connected with no battery installed. Alternates with the battery missing icon above.

## Sleep Mode Power Icons

### Battery Charging



The AC adaptor is connected and the Wireless Battery Module is being charged. Battery segments (bars) indicate battery charge level. (black battery; white background)



Standard Battery is being charged  
(black battery; white background)

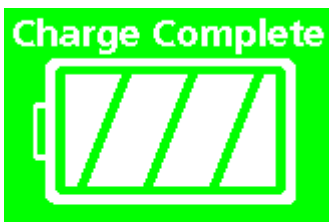

Wireless Battery Module is fully charged  
(white battery; green background)



Battery Error. An error code number may also be displayed. Refer to the Service Manual for a description of the error code. (red battery)



AC power is supplied and battery pack is not installed. (black battery)



Initial pump screen when AC power is supplied and the pump is powered off. Battery charger is determining the current status of the installed battery. (black battery)

## Wireless Icons

These icons are only visible when Wireless Battery Module is installed. They appear in the upper right corner of the pump.



Initializing; The dot will circle the tower. Events are not sent to the network host. (Red background)



Searching for the network and host. The “?” will toggle to the left and right of the tower while searching. Events will be sent to the network upon connection to the network host. (Yellow background)



Connected to host. Signals will radiate outward. Events are sent to the network host. (Green background)



Network disabled or Wireless battery removed. Events are not sent to the network host. (Gray background)



Network module error. Events are not sent to the network host. (inverting Red and White background)



A new Drug Library has been received the information and is ready for activation. This icon can appear within any of the icon listed above.

The figure below shows the key lock and power icon (upper left) and the network connection wireless icon (upper right).

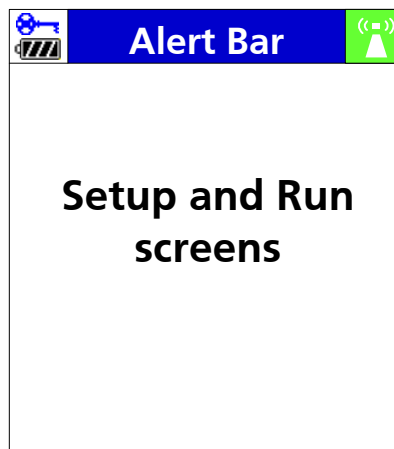

Figure 71. Icon Displays

## General Icons

The following icons are displayed on various screens in the Spectrum:



The “keypad lock” icon is shown in the upper left corner (above the power icon) of the display whenever the lock code has been entered to enable the keypad lock feature.



This icon shall be displayed next to any configuration item in the options menu (User or Biomed) whose setting has been assigned in the Master Drug Library Editor to the currently selected drug.

## APPENDIX H- SPECTRUM DEFAULT SETTINGS

### Factory Settings for Pump Software

Once a user changes these defaults, they will remain at the most current setting. Some settings can be controlled by the Drug Library, as indicated below. These settings are hard defaults that cannot be changed by the clinician programming the pump, unless noted otherwise below.

**Table 1: User Options - Alarm Settings**

Feature	Original Factory Default	User Options	Ability to be Controlled by the Drug Library
Audio Volume	Medium	Low, Medium, High	Yes (Drug Level Configuration)
Audio Tone	Long	Long, Short	No
Standby Delay	Infinite	Infinite, Specified Time frame	No
Bag Near Empty Alert	Off	On, Off	Yes (Drug Level Configuration)
Downstream Pressure Limit	Medium	Low, Medium, High	Yes* (Care Area Level Configuration)
*Downstream Pressure Limit can be set in the Drug Library by Care Area. The user still retains the ability to change this setting at the pump level, but the pump will default back to the Drug Library setting.			

**BASIC Configurations**

**Table 2: User Options - Display Settings - SETUP Options**

Feature	Original Factory Default	Ability to be Controlled by the Drug Library
RUN Screen Options: Audio Level Indicator	Off	No
*Rate mL/hr	On	No
*Dose rate	On	No
*mL - VTBI	Off	No
*Time (hr:min)	Off	No
(*setting N/A in Cyclic TPN Mode)		
Display Adjust	10 (highest level)	No

A BASIC infusion provides for NON DERS based infusion programming.

Drug Library Limits (DERS) do not exist when using BASIC mode. BASIC allows the user to manually specify a mL/hr rate, dose mode, dose rate, and volume to be infused, among other parameters. It does possess the Gen 2 features: Check Flow at Run, Secondary Error Prevention, and Single Step Titration Rate Change of 101%.

---

**CAUTION:** The use of BASIC programming should be restricted and actively monitored by a hospital's QA, Risk, Pharmacy, and Nursing departments.

---

**Table 3: BASIC Fixed Settings**

BASIC Configuration Settings	Fixed Settings
Allow Bolus	Yes
Allowing Loading Dose	No
Delayed Run	Not Available
KVO Rate	1 mL/hr
Secondary Callback	Not Available
Single Step Rate Change	101%

**Table 4: BASIC Settings Configurable in the Drug Library**

BASIC Configuration Settings	Default Settings
Temporary Upstream Occlusion Alarm Suspension	Feature Enabled See “Upstream Suspension Prompts for Primary and Secondary Infusions” on page 63.

**Table 5: Dose Modes Available in BASIC Mode**

BASIC Configuration Settings	Default Settings
Any Infusion while in BASIC Mode.	mL/hr, mL/kg/min, mL/kg/hr, g/hr, mg/hr, mg/kg/hr, mg/min, mg/kg/min, mg/kg/day, mcg/hr, mg/kg/hr, mcg/min, mcg/kg/min, mcg/kg/day, ng/min, ng/kg/min, Units/hr, Units/kg/hr, Units/min, Units/kg/min, mUnits/min, mUnits/kg/hr, mUnits/kg/min, mEq/hr, mEq/kg/hr, mmol/hr, mmol/kg/hr.