

3000 SERIES

SYRINGE INFUSION PUMP

Medex Inc., Duluth, Georgia 30097 USA

Operation Manual

Table of Contents

- IMPORTANT NOTICES..... 1**
- INTRODUCTION..... 2**
- INTENDED USE, FEATURES & CONTROLS 3**
 - Correct Use of This Pump 3
 - 3010 and 3010a Features & Controls 4
 - Keypad & Functions..... 5
 - Using Front Panel Control Buttons 6
 - Understanding Front Panel Indicators 7
 - What Indicators Mean 7
- TECHNICAL SPECIFICATIONS & DEFINITIONS 8**
 - Technical Definitions 9
 - Syringe Manufacturers & Standard Sizes..... 10
 - Trademark Information* 11
- OPERATION WARNINGS & CAUTIONS 12**
 - Warnings 12
 - Cautions..... 14
 - Guidelines For Enhanced Pump Performance..... 15
 - Always Use Smallest Syringe For Volume Of Fluid Being Delivered* 15
 - Use Small Internal Diameter Tubing*..... 16
- ALARMS & REMEDIES..... 16**
 - Alarms / Alerts 16
 - “Neglected Pump” Alarm..... 17
 - “Syringe Near Empty” Alarm During Delivery 18
 - “Syringe Empty” Alarm During Delivery 18
 - “Syringe Empty – Manual” Alarm During Delivery..... 19
 - General System Alarms & Alerts 19

SETUP & LOAD SYRINGES23

- Turning On The Pump23
 - What If The Pump Does Not Turn On?*23
- Selecting Delivery Mode24
- Syringe Manufacturer Setup25
 - What If Only One Syringe Manufacturer Is Setup?*25
- Loading The Syringe Onto The Pump26
- Priming The System28
- Unloading The Syringe29

STARTING & STOPPING INFUSION DELIVERY30

- Start Delivery From Pause30
- Starting Delivery from Standby31
- Making Changes During Delivery31
- Stopping Delivery32
- Turning Off the Pump32

PROGRAMMING DELIVERY MODES33

- Overview of Programming Steps33
 - Apparently Missing or Different Steps*33
 - A Repeated Warning*34
- Continuous Mode: ml/hr34
- Mass Modes: mg/min – mg/hr – mcg/min – mcg/hr – mU/min – mU/hr – u/min – u/hr35
- Body Weight Infusion Deliveries: mcg/kg/min – mcg/kg/hr – mg/kg/min – mg/kg/hr37
- Volume / Time – ml/hr38
- Intermittent Volume / Time40
- Recall Last Settings42
 - Custom Dilution*43
 - Types of Custom Dilution Available*43
- Calculating Dilutions for: mcg/kg/min – mcg/kg/hr – mg/kg/min – mg/kg/hr44

BOLUS DOSING47

- Setup Bolus Dosing47
- Delivering A Bolus Dose49

3010 / 3010a	MEDEX
LOADING DOSES	50
Setting a Loading Dose	50
Delivering A Loading Dose.....	52
VOLUME LIMIT	53
Setting Volume Limit.....	53
KEEP VEIN OPEN (KVO) RATE	55
Programming KVO Rate	55
Delivery At KVO Rate	57
STANDBY	58
Programming Standby.....	58
DELIVERY	60
Starting Delivery	60
Stopping Delivery.....	61
Occlusion Trend Graph During Delivery	61
Post Occlusion Bolus Reduction	63
Time to Occlusion	64
Flow Delivery Graphs	65
CHANGING DELIVERY RATE	67
Titrate Rate During Delivery.....	67
Changing Rate During Delivery.....	68
Changing Rate When Paused	69
TOTAL VOLUME, PROGRAM VOLUME / DOSE DELIVERED	70
Displaying Program Volume Delivered / Program Dose Delivered.....	70
Clearing Total Volume, Program Volume, or Program Dose Delivered Display	71
KEYPAD LOCK	72
USER DEFINED LIBRARIES	73
What <u>Are</u> Libraries?	73

MEDEX	3010 / 3010a
<i>For What Are Libraries and Templates Used?</i>	73
<i>Who Can Use These Libraries of Templates?</i>	73
<i>Types of Programmable Libraries</i>	73
<i>Library and Template Warnings & Cautions</i>	74
Using “Standard” Libraries.....	75
How to Tell Whether E-Plates Are Enabled For Use	76
<i>E-Plates is Disabled</i>	76
<i>E-Plates Is Enabled</i>	76
Using E-Plates	78
Enabling E-Plates & Standard Libraries.....	79
Creating Library Templates.....	79
Transferring Libraries From Pump to Pump.....	79
BATTERY, AC & EXTERNAL DC POWER OPERATION	80
Onscreen Display of Internal Battery Power Level Gauge.....	80
<i>Battery guidelines</i>	81
External DC Power Option	81
CLEANING AND CARE	82
MAINTENANCE & SERVICE	83
Periodic Maintenance	83
Using Medex Service Assistance.....	84
Returning a 3010 or 3010a Pump for Repair	85
MEDEX LIMITED WARRANTY	86
APPENDIX 1: SYRINGE FLOW RATE BY MANUFACTURER & SIZE	87
APPENDIX 2: FLOW DELIVERY CALCULATIONS.....	88
Mass modes	88
Body Weight modes	89
Volume / Time & Intermittent modes.....	89
Custom Dilution Algorithm.....	90
<i>The Results From The Dilution Calculation</i>	90

3010 / 3010a	MEDEX
<i>How the Calculation is Performed</i>	90
<i>Goal of This Dilution Calculation</i>	91
APPENDIX 3: SERIAL COMMUNICATIONS	92
Serial Conversion Box.....	92
Medex Cloning Block.....	92
APPENDIX 4: POLE CLAMP ASSEMBLY & USE	93
Using the 3000 Series Pump Stationary Pole Clamp.....	93
Assembling the 3000 Series Pump Stationary Pole Clamp.....	94
Assembling the 3000 Series Pump Rotating/Detachable Pole Clamp.....	94
APPENDIX 5: MRI ROOM USAGE	97
MRI ROOM USAGE FOR THE 3010 and 3010a.....	97
◆ Proper Placement of Pump.....	97
◆ Pulse Sequences for MRI when using the 3010 and 3010a.....	97

IMPORTANT NOTICES

The notices in the table below contain important information you need to know and understand before beginning to use the **3010 or 3010a** pump. All users of this pump are responsible for knowing this information.

	Before using any 3010 or 3010a , you the operator must be thoroughly familiar with the contents of the operations manual, including all warnings, cautions, and instructions for use. If you use this pump, you are responsible for knowing these things.
Usability	This manual and its contents are valid for use with all software versions starting with 2.0.x ; for example, 2.0.0, 2.0.1, etc.
Warning!	This syringe infusion pump is intended for use only under direction of trained medical professionals.
Caution	United States Federal law restricts this device to sale by or on the order of a physician.

© 1998 – 1999 by MedexMedical -. All Rights Reserved.

Manufacturer: MedexMedical, Duluth, Georgia, USA Tel: 800-848-1757

Authorized EU representative: Medex Medical Ltd., St. Crispin Way, Haslingden

Rossendale, Lancashire, BB4 4PW Great Britain Tel: +44 (0) 1706-233826



INTRODUCTION

The 3010 and 3010a syringe infusion pumps are designed for use in critical care areas for the administration of fluids requiring precisely controlled infusion rates. Because of the pump's simplicity and ease of use, this pump can also be used successfully in the non-critical areas of a clinical setting.

The only people authorized to setup & monitor any infusion are nurses, physicians, or other health-care professionals with training in infusion therapy and operation of the syringe pump.

The 3010 and 3010a Syringe pumps are indicated for use with the following delivery routes:

- Arterial
- Epidural
- Intravenous
- Spinal
- Subcutaneous

The 3010 and 3010a Syringe pumps are indicated for delivering the following fluids:

- Intravenous solutions
- Drug solutions
- Blood or blood products

The 3010 and 3010a Syringe pumps are for use with the following delivery modes

- Continuous
- Volume / Time
- Mass
- Body weight
- Custom dilution
- Intermittent Volume / Time

WARNING! Pump Usage

This syringe infusion pump is intended for use only under direction of trained medical professionals.

Before using any 3010 or 3010a, you must be thoroughly familiar with this manual, including: all Warnings, Cautions, and instructions for use

INTENDED USE, FEATURES & CONTROLS

This chapter defines basic use parameters, features and control options of the **3010 and 3010a** infusion pumps.

CORRECT USE OF THIS PUMP

The correct use of the **3010 and 3010a** infusion pump should be based on the following principles:

1. **This syringe pump is intended for intravenous, subcutaneous, epidural, spinal, and arterial infusions of critical medications or fluids requiring precisely controlled infusion rates.**
2. **Use only syringe manufacturers and sizes listed in the technical specifications of this manual.**
3. **Ensure all medications or fluids are compatible with the syringe, catheters, tubing, and fittings used in the infusion setup.**
4. **Always ensure fluids are compatible with each other when infusing more than one fluid or medication through the same infusion site. If connecting more than one pump to the same infusion site, use one-way check valves to prevent pumps from interfering with each other. Verify that the pumps will operate together without alarming.**

Warning! Failure to strictly adhere to these principles of use can cause *over-infusion* or *under-infusion*, with possibility of serious injury or death.

Warning! ECMO use	This pump is not intended for use on the inlet side of <i>Extracorporeal Membrane Oxygenation (ECMO)</i> systems where high negative pressures can occur.
-----------------------------	---

Warning! Check Magnetic Fields Above 150 Gauss	Never use the pump in magnetic fields above 150 gauss. Always secure the pump to a non-moveable object. In magnetic fields above 150 gauss, the attraction of the pump to the magnet may be a hazard. This pump may be operated in static magnetic fields up to 150 gauss for specific MRI devices identified in Appendix 5.
--	---

3010 AND 3010A FEATURES & CONTROLS

Below is an illustration of the pump in a front view, with callouts identifying major elements:

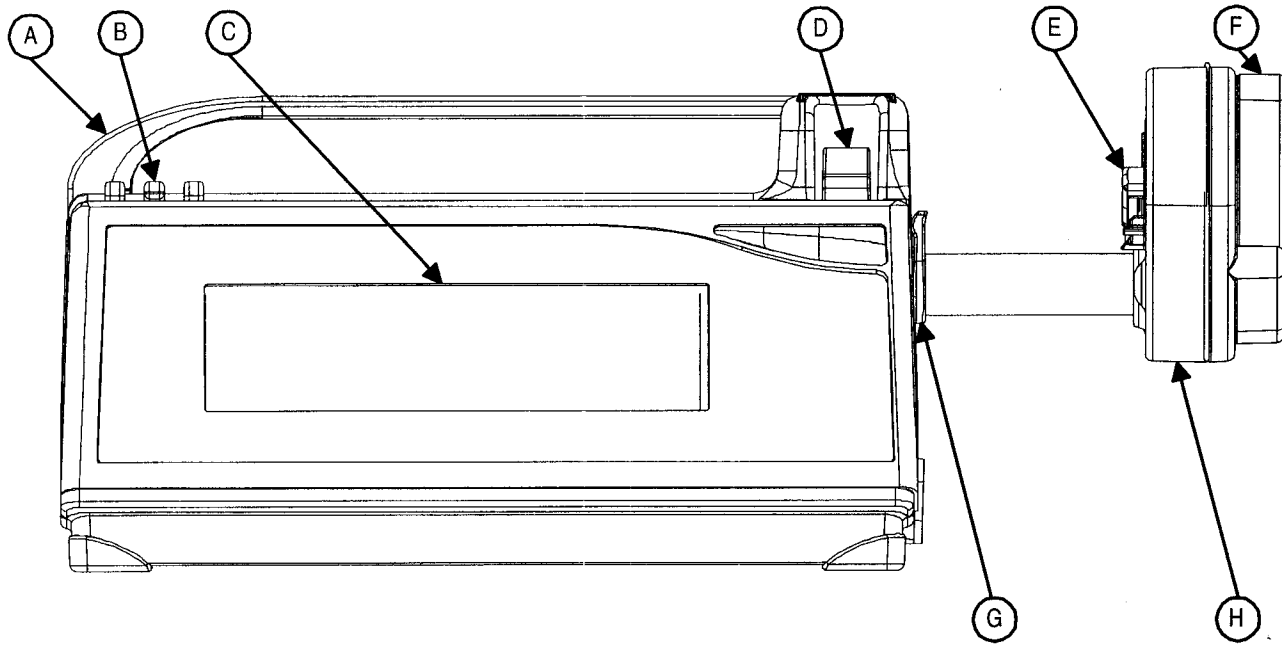

- | | | |
|---------------------------------------|------------------------------------|--|
| A – Handle | B – Tubing Holders | C – Display |
| D – Syringe Barrel Clamp | E – Syringe Plunger Holders | F – Syringe Plunger Release Lever |
| G – Syringe Barrel Flange Clip | H – Syringe Plunger Driver | |

KEYPAD & FUNCTIONS

Below is an illustration of the front panel of the 3010 and 3010a, with tables below identifying functions and effects:

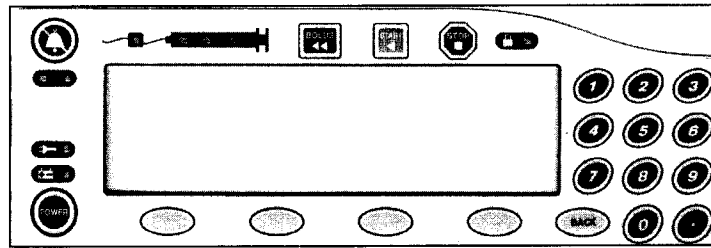

Control Button	When Pump is Paused	When Pump is Delivering
Power	Push and hold to turn OFF pump.	Push & release, then push & hold to turn OFF.
Start	Starts delivery.	N/A
Stop	N/A	Stops delivery.
Bolus	Begins priming after confirmation.	Begins programmed bolus after confirmation.
- Alarm Silence	Silences audible alarm.	Silences audible alarm.
- Lock	N/A	Indicates pump controls are locked.
Numerals & Decimal	Set number values or selects options.	Set number values or selects option.
Back	Reverts to previous step or level.	Reverts to previous level, or step if adjusting settings.
"Menu Buttons 1-4"	Function defined on screen.	Function defined on screen.





USING FRONT PANEL CONTROL BUTTONS

Below is a table of the 3010 and 3010a front panel buttons and their assigned functions:

Button	Function
<p>Power</p>	<p>Push and hold to turn the pump ON. Push and hold to turn the pump OFF. Pressing the power button while the pump is infusing results in a message asking you to press the power button a second time to turn OFF power.</p>
<p>Start</p>	<p>Starts an infusion after settings are made. Press this button to start infusing after all infusion parameters have been set & reviewed.</p>
<p>Stop</p>	<p>Stops an infusion. All delivery (including <i>Keep-Vein-Open</i>) pauses.</p>
<p>Bolus</p>	<p>Starts bolus infusion or primes the pump.</p> <ul style="list-style-type: none"> Press Bolus button when the pump is paused to call the PRIMING screen, then press and hold this button to prime. <p>Press Bolus button when the pump is infusing to call the BOLUS CONFIRM screen, then press the menu button to confirm the bolus dose and start the bolus delivery.</p>
<p>Alarm Silence </p>	<p>Silences an alarm for a programmed delay period. The usual is 2 minutes Any new alarms occurring within the delay period sound immediately. When the delay period expires, any audible portion of the highest priority alarm still present will sound.</p>
<p>Back</p>	<p>Pressing this button exits the current data entry operation and reverts to previous operation screen.</p>
<p>Menu Buttons</p>	<p>The four buttons directly below the display are software-defined buttons, with assigned function varying from screen to screen. The bottom line of the display defines the function for these buttons.</p>





UNDERSTANDING FRONT PANEL INDICATORS

Below is a table of function indicators and their effects while using the pump.

Indicator	Pump Off	Pump Paused	Pump Delivering
 – AC Line Indicator	ON when AC powered.	ON when AC powered.	ON when AC powered.
 – Battery Indicator	ON when charging.	ON when charging. Flashing when battery in use.	ON when charging. Flashing when battery in use.
 – Lock Indicator	OFF	OFF	ON when keypad is locked.
 – Infusing Indicator	OFF	OFF	Flashing from right to left.

WHAT INDICATORS MEAN

Below is a table of front panel indicators and what each of them means:

Indicator	What it means
 – Alarm Indicators	The ALARM indicators (yellow or red) are on whenever the pump is in an alarm condition. The specific details of each alarm are covered in the Alarm section later in this manual.
 – AC Line Indicator	The AC LINE indicator (green) is ON whenever the pump is connected to “mains” line power. It is OFF when the pump is not connected to an active AC line.
 – Battery Indicator	The BATTERY indicator (green) blinks ON&OFF whenever the pump is operating on internal battery power, and remains ON when battery is charging.
 – Lock Indicator	The LOCK indicator () tells you the pump has been locked into its current operational mode. While this indicator is lighted, the keypad is locked and no changes can be made to settings. Attempting to stop or change an infusion while locked will result in an alarm and an advisory message.
 – Infusing Indicator	The Infusing indicators are 3 green lights, which illuminate in sequence right to left when the pump is infusing. During intermittent delivery mode, a single Infusing indicator lights during the time between infusions.





TECHNICAL SPECIFICATIONS & DEFINITIONS

Below are the technical specifications of the **3010 and 3010a** infusion pumps:

Category	Specification	
Dimensions (pump only)	10.5" wide x 5.1" high x 5.5" deep (27 cm x 13 cm x 14 cm)	
Weight (pump only)	3.8 lbs. (1.7 kg)	
Accuracy	Nominal ± 2% excluding syringe variations (for infusion back pressures of -100 mm Hg to +300 mm Hg)	
Flow Rate Range (depends on syringe size)	0.03 ml/hr to 1130 ml/hr for the Protégé 3010 0.01 ml/hr to 1130 ml/hr for the Medfusion 3010a	
Delivery modes (user customized)	ml/hr Volume / Time Mass	Body Weight Custom Dilution Intermittent
Delivery options (user customized)	Volume Limit Bolus Dose Loading Dose	KVO Rate Standby Override Occlusion Limit
AC power source	100-240 VAC, 50/60 Hz, 30VA Safety Class II – Type CF	
External DC power source (Optional)	External DC Input 6 – 14 VDC, 7 Watts Safety Class II – Type CF (must meet IEC 601-1 Medical Equipment Standards)	
Internal Battery Capacity (at 25°C)	Rechargeable. 10 hours at 5.0 ml/hr with 60 ml syringe – (from fully charged battery)	
User-defined Delivery Libraries	Four libraries with 16 profiles per library One library is "E-Plates" for rapid setup	
Normal Operating Conditions	Temperature: 5° to 40° C (40° to 104° F) Relative Humidity: 15 to 95% non-condensing Ambient Pressure: 70 kPa to 106 kPa (10.2 psia to 15.4 psia) Infusion Back Pressure: -100 mmHg to 300 mmHg	

TECHNICAL DEFINITIONS

Below is a table of technical definitions as required per international standards:

Term	Definition
 Class II	Equipment in which protection against electrical shock relies on double or reinforced insulation instead of basic insulation. Accessible metal components of pump enclosure use this higher level of insulation instead of safety grounding.
 Type CF	Equipment in which level of protection from electrical shock is defined by leakage current (C) exposure and insulation by isolated or floating (F) metal of pump enclosure relative to earth grounding. Under normal conditions, users are exposed to no more than 100 microamps – when measured through the pump, and patients to no more than 10 microamps – when measured through IV path.
Infusion Class 4	An infusion pump that combines the functions of continuous infusion flow, intermittent flow, and discrete bolus delivery.
Infusion Class 5	An infusion pump that functions as a profile pump, providing a programmed sequence of delivery rates.
IPX3	Equipment that is ingress protected from fluid spraying at vertical angle from above, and from angles to 60° on either side of vertical.
V ~	Symbol for operating voltage range for alternating current (i.e. AC or mains) power source.
	Symbol for infrared serial communications port on pump.
	Symbol for external DC jack connection. Tip (negative sign) is for power ground and ring (positive sign) is for positive power connection. [See warning below.]

<p>Warning! External Power must be IEC 601-1 Certified</p>	<p>Any external power source connected to the DC jack must be IEC 601-1 certified for medical equipment Type CF and meet Safety Class II. Connecting any external power source to the pump creates a medical system. Therefore, the user is responsible for compliance with IEC 601-1 standards. Refer all questions to the Medex Technical Service Department.</p>
---	--

SYRINGE MANUFACTURERS & STANDARD SIZES

Below is a table of syringe manufacturers for which the 3010 and/or 3010a has been designed, and the specific syringe sizes programmed into the pump database for use with the pump.

Manufacturer	Syringe Sizes
B. Braun	Omnifix® 5, 10, 20, and 50 ml Luer Lock Perfusor® 20 and 50cc Luer Lock
Becton-Dickenson Luer Lok®	B-D 3, 5, 10, 20, 30, and 60 ml Luer Lock B-D 1cc Luer Lock, and 1cc Tuberculin (3010a only)
Becton-Dickenson Glass	2.5, 5 and 10 ml Luer Slip 1cc (3010a only)
Monoject®	3, 6, 12, 20, 35, and 60 ml Luer Lock 1cc (3010a only)
Terumo®	3, 5, 10, 20, 30, and 60 ml Luer Lock 1cc (3010a only)
AstraZeneca®	50 ml pre-filled Diprivan® Luer Lock

<p>Warning! Critical Volume</p>	<p>The critical volume (for <i>volume limit</i>) which could be infused in the event of a single point positional failure in this infusion pump is 1/100th of the syringe fill volume.</p> <p>At <i>any rate</i> the critical volume (for <i>rate</i>) in this infusion pump is 1/400th of the syringe fill volume.</p>
--	---

TRADEMARK INFORMATION

Below is a table of registered trademarks and the manufacturers owning them:

Trademark	Owner / Manufacturer
"Omnifix" and "Perfusor"	B.Braun Medical AG
"B-D"	Becton Dickinson and Co
"Monoject"	Sherwood Medical
"Diprivan"	AstraZeneca Pharmaceutical

OPERATION WARNINGS & CAUTIONS

This chapter contains vital information in the form of warnings and cautions that apply to operation of this infusion pump. As an operator of this pump, you are responsible for knowing and using this information.

WARNINGS

Below is a table of warnings and conditions for operation of the **3010 and 3010a** infusion pumps. Other warnings are posted throughout this manual. A **“Warning”** defines a potentially *serious life-safety hazard*, specific limitations for using this device imposed by the hazard, and the steps for avoiding the hazard.

Operational Warnings	
Avoid Air Emboli	Always purge all air from syringe and infusion lines before connecting to the patient. Air infused into a patient may cause serious injury and/or death..
Flammables	DANGER! Never use pump in presence of flammable anesthetics, oxygen-enriched atmospheres, or explosive gases.
Manufacturer Guidelines	Always read manufacturer precautions and guidelines for medications or fluids infused with this pump. Medications or fluids may interact with the plastic components of the infusion syringe and sets. This interaction may result in serious injury and/or death to the patient.
Priming New Syringes	Always use the Prime function on the pump when loading a new syringe in order to remove any mechanical slack. Failure to prime correctly can delay infusion delivery and cause <i>Total Volume Delivered</i> to read higher than what is actually delivered to the patient.
Don't Prime the Patient	Never operate the Prime function while pump is connected to the patient infusion site. Using the pump in the Prime function may cause over-infusion, with possible serious injury or death to patient.
Confirm All Settings	Before starting ANY delivery, ALWAYS confirm correctness of ALL infusion values you just set.
Syringe Matching	Only use syringe sizes and manufacturers listed in this manual. Use of other syringe manufacturers or sizes may possibly cause an under-infusion or over-infusion to the patient that could result in serious injury and/or death.
Verify Syringe Make & Size	Always confirm syringe manufacturer and syringe size displayed on the pump match the manufacturer and syringe size loaded into the pump. Mismatching syringe make or size may possibly cause an under-infusion or over-infusion to the patient that could result in serious injury and/or death.
Check Magnetic Fields Above 150 Gauss	Never use the pump in magnetic fields above 150 gauss. Always secure the pump to a non-movable object. In magnetic fields above 150 gauss, the attraction of the pump to the magnet may be a hazard. This pump may be operated in static magnetic fields up to 150 gauss for specific MRI devices identified in Appendix 5.

Operational Warnings <small>(continued)</small>	
Vertical Displacement	Once the syringe and tubing system is connected to the patient, raising the system above the patient (even briefly) can cause significant bolusing due to changes in hydrostatic pressure. Lowering the system below the patient (even briefly) can cause significant interruptions in flow due to changes in hydrostatic pressure.
Select right syringe size	Use the smallest syringe size to deliver the fluid or medication. Running a large syringe at very low rates may cause under-delivery, e.g. a long time to occlusion alarm. See the section on guidelines for enhanced performance and review startup curves and time to occlusion information when selecting a syringe.
Trained Users	Only this use pump under direction of trained medical professionals. Before using this pump, you must become thoroughly familiar with this manual, including warnings, cautions, and instructions for use.
Turn Off Fluid Flow When Loading a Syringe	Always turn OFF fluid flow to patient in tubing via clamp or stopcock before loading or unloading syringe onto the pump. Uncontrolled fluid flow can occur when fluid set is not clamped or turned off, and may cause serious injury and/or death.
Secure the Syringe	Always be sure to secure the syringe barrel, flange and plunger, with tubing threaded through holding clamp. Failure to properly secure the syringe and tubing can result in uncontrolled fluid flow into a patient, which can result in serious injury and/or death.
Horizontal Operation Only	Always operate this pump in horizontal position to prevent fluid leakage into the pump. If you suspect fluid has leaked into it, remove pump from service until it can be tested by a trained biomedical technician.
External DC Power must be IEC 601-1 Certified	Any external power source used with this pump must be IEC 601-1 certified for medical equipment Type CF and meet safety class II. Connecting an external power source to the pump creates a medical system. The user is responsible for complying with IEC 601-1 standards. Refer all questions to Medex Technical Service Department.
AC Power	The only means of removing AC power is to disconnect the AC power cord. While the AC power cord is attached to the pump and plugged into an AC outlet, live mains voltage is present inside the pump.
1ccSyringe Occlusion Pressure	When a 1cc syringe is entered into the programming the occlusion pressure setting is fixed at very high - 35psi (3010a only)

Service Warnings	
Pump Maintenance	Only trained biomedical service personnel may service this pump. Service personnel should disconnect the AC power cord before servicing the pump.
Manufacturer Recommended Maintenance	Always maintain this pump following manufacturer recommended instructions in the Service Manual. Improperly maintained pumps may cause either under-infusion or over-infusion to patient.
Never open pump case	Users should never open the pump case or battery compartment for any reason. Service personnel should always disconnect the AC power cord before servicing the pump.
System Failure Alarm	Never use a pump when it has signaled a system failure alarm. Withdraw it from service and send it to a trained biomedical technician for service.

Dropped or Damaged Pumps	Never use a dropped or obviously damaged pump . Withdraw it from service until it can be tested by a trained biomedical service technician.
---------------------------------	--

CAUTIONS

Below is a table of CAUTIONS and conditions related to operation of the **3010 and 3010a** infusion pumps. Other cautions are posted throughout this manual. An operational “CAUTION” defines any special care you must exercise for safe & effective use of this device.

Operational Cautions	
Who Can Buy This Pump	United States of America Federal law restricts this device to sale by or on the order of a physician.
Don't Dunk the Pump	Never immerse the pump in water or other fluids. This pump is not waterproof.
Never Autoclave	NEVER sterilize the pump in a steam autoclave or gas sterilizer. Using an autoclave or gas sterilization can seriously damage the pump and void the warranty.
Avoid Strong Solvents	Never use organic solvents to clean or disinfect the pump. Refer to the CLEAN & CARE section of this manual.
Use Correct Manuals	Always ensure the software version of the pump and operations manual agree. Refer to this manual's front page.
Avoid Sharp Objects	Never use sharp objects to depress control buttons on the pump. They may damage the pump by rendering buttons inoperable.
Check for Leaks	Always periodically check the fluid pathway and connections for leaks. As with any infusion system, leaks may cause patient or infusate fluid loss.
Correct Disposal	Follow your institution's procedures and applicable laws regarding the proper disposal or recycling of device components.

GUIDELINES FOR ENHANCED PUMP PERFORMANCE

The following are guidelines for enhanced syringe pump performance. Review occlusion time and flow delivery graphs in Delivery section. Because of the way syringe pumps operate, clinicians should use appropriate syringe size, tubing, and inline devices for expediting delivery of medication or fluid. Certain factors enhance syringe pump performance, where performance is defined as:

- a) *Time to Detect Occlusion*
- b) *Continuity of Flow*
- c) *Startup Time*

ALWAYS USE SMALLEST SYRINGE FOR VOLUME OF FLUID BEING DELIVERED

It is all too easy to fall into a pattern of using the same syringe size, or sizes to infuse medications or fluids. It is recommended to always using the smallest syringe that can get the job done. This can help avoid a variety of problems.

Friction and compliance of the syringe plunger tip affect delivery startup and flow continuity. The bigger the syringe, the greater the friction and compliance, the slower the startup. Use a smaller syringe when running at a lower rate.

The table below recommends minimum delivery rates by syringe size, when programming flow rates, a limited priority alarm will be activated with an advisory message on the screen if a rate below those recommended here is entered:

Syringe size	Lowest Recommended Rate
60 ml	2.0 ml/hr
30 ml	1.0 ml/hr
20 ml	0.67 ml/hr
10 ml	0.33 ml/hr
5 ml	0.17 ml/hr
3 ml	0.10 ml/hr
1 ml	0.03 ml/hr

Note: this table is only a guideline because syringes and infusion setups vary.

<p>Low-priority</p>	<p>A <i>low-priority alarm</i> indicates any condition not requiring immediate operator intervention. Low-priority alarms are announced with a continuous yellow indicator and a single audible signal. If the front panel controls are <u>locked</u> when a low-priority alarm occurs, the pump controls do not unlock.</p>
<p>Limit Priority</p>	<p>A <i>limit-priority alarm</i> sounds a tone and displays an advisory message onscreen for 3 seconds. If the front panel controls are <u>locked</u> when a low-priority alarm occurs, the pump controls do not unlock.</p>

“NEGLECTED PUMP” ALARM

The “*Neglected Pump*” alarm is a low priority alert. It is simply reminding you to finish what you started. Once you begin programming any infusion delivery, the pump expects you to continue until setup is complete.

If you “forget” and leave the pump paused too long (30 seconds) on a data entry screen, then the pump initiates a medium-priority “user callback” alarm.

There are several basic resolutions:

- ☞ Press the **Alarm Silence** button “” or ANY button to silence the alarm for another 30 seconds.
- ☞ Go to the BEGIN INFUSION screen. There the alarm silence interval is at least 2 minutes or longer – depending on custom configuration.
- ☞ Press the **Start** button to begin the infusion.
- ☞ You can cancel the infusion and return to the SELECT THE MODE screen, where no alarms sound.
- ☞ You can press & hold the **Power** button and turn off the pump.

“SYRINGE NEAR EMPTY” ALARM DURING DELIVERY

The “Near Empty” alarm is a low-priority alarm during delivery telling you the syringe is “just about” empty. The pump beeps, displays the near empty alarm message appears onscreen, and does not stop delivery.

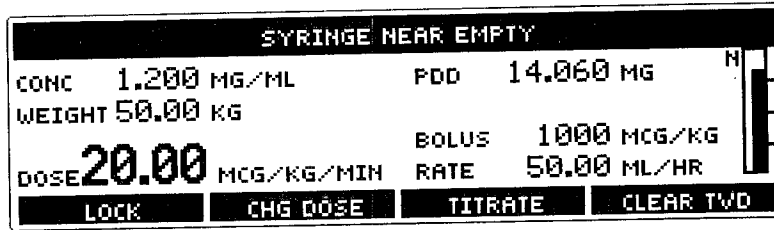

1. Confirm how long you have before the infusion ends.
2. Then be prepared to load a new syringe onto the pump if necessary, and then start a new infusion.

Calculating Near Empty Status	Near empty status is calculated by checking the <i>volume remaining</i> in the syringe against the <i>near empty alarm time setting</i> <u>divided</u> by <i>current delivery rate</i> .
-------------------------------	--

“SYRINGE EMPTY” ALARM DURING DELIVERY

The SYRINGE EMPTY alarm is a *high priority* alarm advising the syringe is empty.

1. The EMPTY alarm stops delivery immediately.
2. Press the **Alarm Silence** button “🔕” to clear the alarm tone & message.
3. Unload the syringe.
4. Either prepare and load another syringe, or turn off the pump.

Calculating Empty Status Caution Monoject 3cc	Empty status is determined by measuring <i>plunger position of syringe</i> <u>against</u> <i>set value for syringe size & manufacturer</i> .
	Because of variations in syringe manufacturing, the Monoject 3cc syringe may in some cases not fully empty. Here, the empty alarm sounds with some fluid left in the syringe.





“SYRINGE EMPTY – MANUAL” ALARM DURING DELIVERY







It is possible to override a “syringe empty” alarm sounded during delivery. There will be times when the pump calculates the syringe is empty ... and yet there remains a residual volume of medication or fluid in the syringes. A common cause is variation in manufacturing of syringes.

1. Press the **Alarm Silence** button. The pump has stopped delivery and is at the BEGIN INFUSION screen.
2. If you do not wish to deliver this remaining fluid, then:
 - a) Unload the syringe.
 - b) Either prepare and load another syringe, or turn off the pump.
3. If you do wish to deliver the remaining fluid, then press the **Start** button.
4. The pump begins delivery, and continues until no fluid remains in the syringe.
5. As soon as the pump senses an *occlusion*, it halts delivery and displays the “Syringe Empty – Manual” message onscreen.
6. Press the **Alarm Silence** button. The pump has stopped delivery and is at the BEGIN INFUSION screen.
7. Either prepare and load another syringe, or turn off the pump.

GENERAL SYSTEM ALARMS & ALERTS

This section contains a table of the general system alarms you may encounter while operating the **3010 or 3010a** infusion pumps. This table identifies the alarm by message and type, then provides

Alarm Message	Priority	Remedy
Battery Communication Timeout	Low	The internal battery is not working. The pump may be used on AC power on a conditional basis. As soon as possible, remove pump from service for repair by a trained biomedical service technician.
Battery Not Charging	Low	The internal battery is not working. The pump may be used on AC power on a conditional basis. As soon as possible, remove pump from service for repair by a trained biomedical service technician.
Battery Not Working	Medium	Press Alarm Silence button "  ". The internal battery is not working. The pump may be used on AC power on a conditional basis. As soon as possible, remove pump from service for repair by a trained biomedical service technician.
Check Clutch / Plunger Lever	High	Press Alarm Silence button "  ". The syringe is not loaded correctly. Check the plunger lever and ensure it is all the way up.
Check Syringe Flange Sensor	High	Press Alarm Silence button "  ". Sensor is active when syringe is not loaded. Check the syringe flange holder. Ensure the flange holder pulls back to the side of the case. If holder does not operate correctly, immediately remove the pump from service for repair.
Check Syringe Plunger Sensor	High	Press Alarm Silence button "  ". Sensor is active when syringe is not loaded. Check the syringe plunger holders. Ensure the holders move freely. If they do not operate correctly, immediately remove the pump from service for repair.
Completing System Initialization	Limit	Allow pump startup to complete self-testing.
Infusion Complete	High	Press Alarm Silence button "  ". Either begin a new infusion, or turn off the pump.

Alarm Message	Priority	Remedy
KVO In Progress	Medium	Press Alarm Silence button  . Advisory message that volume limit has been reached and KVO infusion is in progress.
Low Battery	Low	Plug in the power cord and run pump on AC mains while recharging the battery.
Invalid Rate for Syringe Size	High	Press Alarm Silence button  . Advisory message in custom dilution program. Consult syringe flow delivery tables in appendix to determine appropriate syringe size.
Invalid Syringe Size	High	Press Alarm Silence button  . Syringe size not recognized for the manufacturer selected. Review syringe sizes in the technical specifications section.
Occlusion – Check Infusion Line	High	Press Alarm Silence button  . Check infusion line for blockage. Clear or remedy any discovered occlusion. Press the Start button to begin infusion.
Pump Is Locked	Limit	Keypad has been locked to prevent changes during infusion. Alarm initiated by pressing any button except Power or Unlock . Press Unlock if you need to make changes to delivery settings. Or press Power button <u>twice</u> to end delivery.
Syringe Barrel Not in Place	High	Press Alarm Silence button  . The syringe is not loaded correctly. Make sure the syringe barrel clamp is correctly positioned and is holding the syringe in place. Proceed with the infusion.
Syringe Flange Not in Place	High	Press Alarm Silence button  . The syringe is not loaded correctly. Make sure the syringe flange is properly inserted into the flange clip. Proceed with the infusion.

Alarm Message	Priority	Remedy
Syringe Plunger Not in Place	High	Press Alarm Silence button "🔇". The syringe is not loaded correctly. Make sure the syringe plunger head is properly inserted. Proceed with the infusion.
Syringe Does Not Match Library Entry	Limit	Program the delivery for the type of syringe you are actually using. Then proceed with infusion setup and start it.
Syringe Empty	High	The pump has halted infusion at empty. Press Alarm Silence button "🔇". You may either: a) Prepare and load another syringe, then begin another infusion. b) Turn off the pump.
Syringe Empty – Manual	High	The pump has halted infusion after overriding empty alarm. Press Alarm Silence button "🔇". You may either: a) Prepare and load another syringe, then begin another infusion. b) Turn off the pump.
Syringe Near Empty	Low	The pump is telling you the syringe will soon be empty.
System Advisory – Maintenance Is Recommended	Low	As soon as possible, remove pump from service for testing and checkout by a trained biomedical service technician.
System Advisory – Set Time and Date	Low	As soon as possible, remove pump from service for testing and checkout by a trained biomedical service technician.
System Advisory – xx Data Corrupted	Low	Infusion will continue using backup copy of <i>xx data</i> . As soon as possible, remove pump from service for testing and checkout by a trained biomedical service technician.
System Failure – aa bb cc	High	Press Power button to turn off pump. <u>Immediately remove pump from service for repair</u> by a trained biomedical service technician.
Below Recommended Rate	Limit	Reminds user that the programmed rate is below that recommended for the syringe size - no remedy required

SETUP & LOAD SYRINGES

Pump setup and syringe loading is a multi-step process, based on your daily practice of infusing patients with medication or other fluids.

TURNING ON THE PUMP

Below are an illustration of the startup screen, and a list of basic steps for turning on the infusion pump.



1. Press and hold the **Power** button until the dark screen appears. Verify the screen shows all pixels on, then all pixels off.
2. The pump should “beep” twice, and then the indicators flash for Alarm, Infusing, and Lock as the self-test cycles. The pump ID, if it has one, appears in the upper left corner. In this case, it is called “Jobara”.
3. You should now verify the display indicates successful completion of system startup self-tests.

WHAT IF THE PUMP DOES NOT TURN ON?

If the pump does not turn ON with successful completion of self-tests, remove it from service and have it checked by a trained biomedical technician.

SELECTING DELIVERY MODE

Below are the steps for selecting a delivery mode for programming with infusion settings:

1. After successfully completing its system startup self-tests, the pump displays the SELECT THE MODE screen.
 - The delivery modes on this screen were setup by **Custom Configuration**, which was completed by the person responsible for custom configuration before the pumps were delivered to your work area.
 - Also, if the pump has been configured with “E-Plates” enabled, the first screen is the SELECT THE LIBRARY ENTRY screen (see User Programmable Libraries).

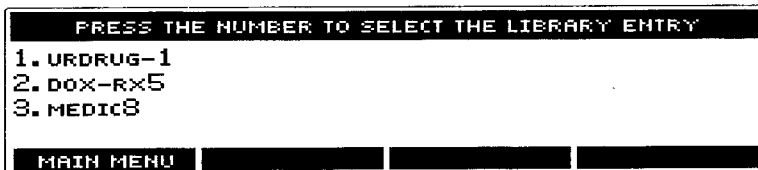

2. If the SELECT THE LIBRARY ENTRY screen appears, press the **Main Menu** button to call the SELECT THE MODE screen.
3. Press any **Number** button to select the desired delivery mode. If you make a mistake use the **Back** button to undo it.
4. If you do not see the mode you need, press the **More** button to display the next page of delivery modes.

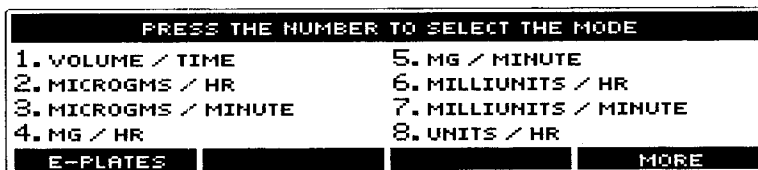

5. At the next menu, either:
 - a) Select an option by pressing its **number**, and continue.
 - b) Or press the **Beginning** button to return to the beginning screen.

SYRINGE MANUFACTURER SETUP

Below is an example for syringe manufacturer setup for use with the **3010 and 3010a** pump:

1. Use your standard protocol for preparing your syringe & tubing and filling the syringe.
2. When delivery mode is chosen, set the syringe information. If more than one manufacturer is configured for the pump then the SELECT SYRINGE MANUFACTURER / TYPE screen appears.
 - The syringe manufacturers on this screen were setup in **Custom Configuration**, which was completed by the person responsible for custom configuration before the pumps were delivered to your work area.



3. Press any **number** button to select the syringe manufacturer. If you make a mistake use the **Back** button to undo it.

WHAT IF ONLY ONE SYRINGE MANUFACTURER IS SETUP?

If only one syringe manufacturer has been setup for use by this pump (through custom configuration), then this entire level, and its screen, is skipped during infusion programming.

LOADING THE SYRINGE ONTO THE PUMP

Below are the steps for loading a syringe onto the infusion pump:

Warning!
Always Turn Off
Fluid Flows

Always turn OFF fluid flow to patient in tubing via clamp or stopcock before loading or unloading syringe onto the pump. Uncontrolled fluid flow can occur when fluid set is not clamped or turned off, and may cause serious injury or death.

After you set the syringe manufacturer information setup in the pump, it is time to install the syringe itself. Load the syringe using to the following steps:

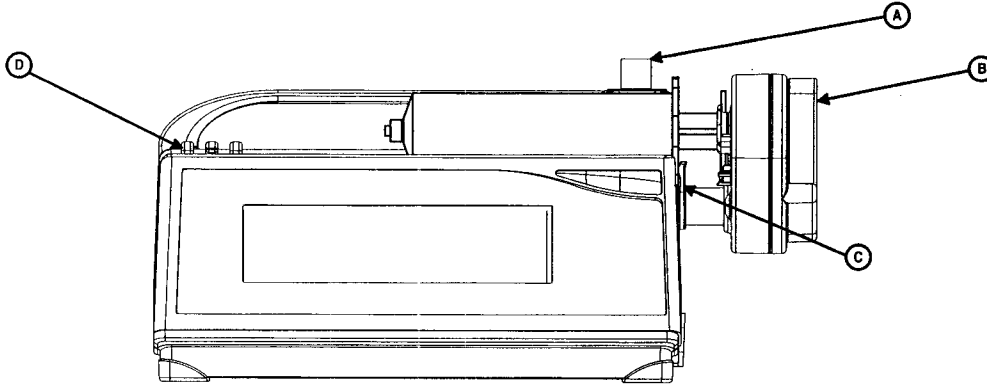

1. Using standard protocol, prepare the syringe by filling it with medication or other fluid, and attaching the tubing.
2. Lift and swivel the syringe *Barrel Clamp* "A" out of the way.
3. Squeeze *Plunger Release Lever* "B" on the syringe plunger driver and pull gently to extend it all the way.
4. Load the syringe onto the pump as illustrated, making sure the flange of syringe barrel is pressed or rolled into *Flange Clip* "C".
5. Squeeze *Plunger Release Lever* "B" on the end of the syringe plunger driver and slip the end of the syringe plunger into place, then release the lever to close it around the syringe. Be sure **both holders** close around the syringe plunger.

Warning!
Capture Plunger

Verify the syringe plunger is securely captured by the plunger holders. Failure to capture the syringe plunger may result in siphoning the syringe.

- 6. Turn and lower *Barrel Clamp* "A" onto the barrel of the syringe. The size should appear in the display. If the syringe is incorrectly loaded, guide arrows appear onscreen to identify the problem.

Down arrow "↓" onscreen means check syringe barrel flange.
Right arrow "←" onscreen means check syringe plunger.
Up arrow "↑" onscreen means check syringe barrel clamp.
- 7. There are no arrows onscreen when the syringe is correctly loaded.
- 8. Make sure the **syringe size** is correctly recognized by the pump, and the syringe **manufacturer** is correct. If not, verify that the manufacturer and size are listed in the technical specifications of this manual.

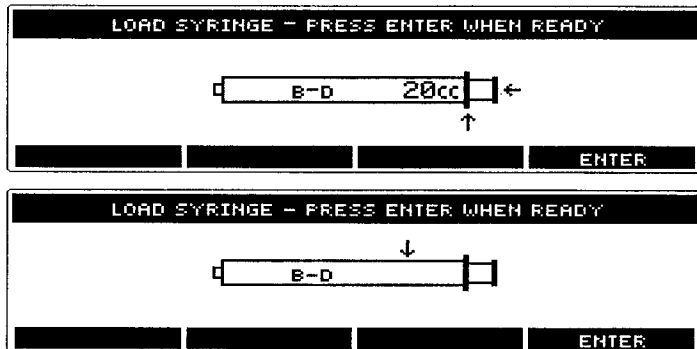

- 9. Thread the tubing through the *3 Tubing Holder* "D" on the top left side of the pump.
- 10. Then press the **Enter** button to confirm this information.

Warning! Match Syringes	The syringe manufacturer & size displayed onscreen must ALWAYS match the actual syringe you are loading. Mismatching syringe manufacturer or size may cause either under-infusion or over-infusion to the patient – with possible serious injury or death.
-----------------------------------	---

PRIMING THE SYSTEM

Priming is accomplished as a secondary function of the **Bolus** button. Always **prime a new syringe after loading it onto the pump**. This removes the *mechanical slack* in the pump and syringe.

Warning! Never Prime the Patient	NEVER prime any syringe while connected to a patient infusion site, as this may cause over-infusion, with possible serious injury or death.
--	--

1. Press the **BOLUS** button to call the priming screen illustrated below.



2. To prime a loaded syringe, press and hold the **BOLUS** button while observing for fluid movement at the patient end of the system.
3. For safety reasons there is a built-in priming cutoff at *15 seconds*. To continue priming after cutoff, release the **BOLUS** button then press & hold again.

Priming Data NOT counted in TVD	The total priming volume accumulates onscreen, but is NOT counted in the Total Volume Delivered display. This is because the prime should never be delivered to the patient. Priming infusion rate is <i>300 ml/hr</i> , or default maximum Bolus rate for the syringe size being used, whichever is lower.
---------------------------------	--

The priming sequence is extremely important to assure the accuracy of the delivery and reduce the start-up time. The priming sequence is performed after the infusion is programmed, and before the delivery is started. The message at the top of the "Begin Infusion" screen will alternate between "Press <START> To Begin Infusion", and "Press <BOLUS> To Prime" to remind the operator of the prime sequence

UNLOADING THE SYRINGE

You unload a syringe exactly the opposite way as you load it. Just use the following steps:

1. Press the **Stop** button to end delivery.
2. Clamp or close infusion line from the syringe to patient.

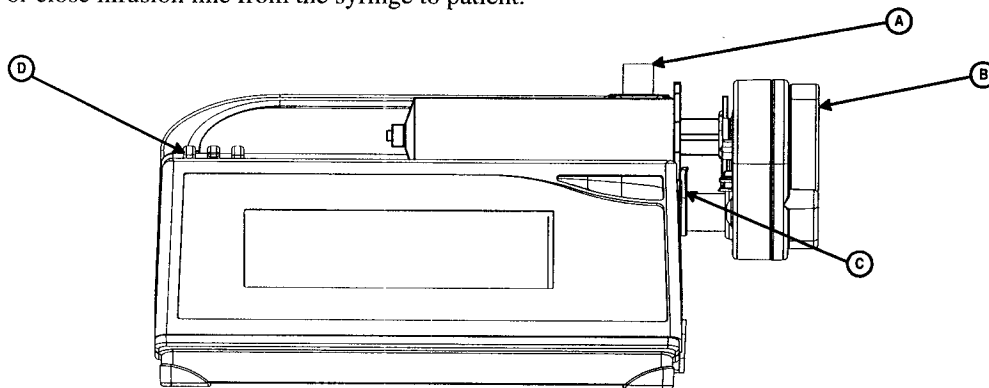

3. Unthread the tubing from the *Tubing Holder* “D” on the top left side of the pump.
4. Lift and swivel the syringe *Barrel Clamp* “A” out of the way.
5. Squeeze the *Plunger Release Lever* “B” on the syringe plunger and remove the syringe.

<p>Warning! Turn Off Fluid Flow</p>	<p>Always turn OFF fluid flow to patient in tubing via clamp or stopcock before loading or unloading syringe onto the pump. Uncontrolled fluid flow can occur when fluid set is not clamped or turned off, and may cause serious injury and/or death.</p>
--	---

STARTING & STOPPING INFUSION DELIVERY

You can start an infusion delivery at any time after you have setup a delivery mode. You can start infusion from a pause or standby screen.

START DELIVERY FROM PAUSE

Whenever you begin an infusion setup and progress all the way through the setup levels, the pump *pauses* at the BEGIN INFUSION screen.

1. Program the delivery mode by setting its variables like rate, volume limit, and so on.
2. When you finish setting the delivery mode, the pump pauses at the BEGIN INFUSION screen.

PRESS <START> TO BEGIN INFUSION			
CONC	250.0 MG/ML	PDD	0.000 MG
WEIGHT	66.50 KG	V LIMIT	60.00 ML
DOSE	150.0 MCG/KG/MIN	BOLUS	2500 MCG/KG
		RATE	2.39 ML/HR
E-PLATES	CHG DOSE	OPTIONS	CLEAR TVD

3. Press the **Start** button on the face of the pump.
4. The pump begins the infusion.

STARTING DELIVERY FROM STANDBY

You can start the infusion at *any time* when the pump is on standby. It is unnecessary to either cancel standby or wait until its period ends.



1. To start infusion from standby or pause, press the **Start** button.
2. Before starting the infusion, you may also:
 - a) Return to the Main menu.
 - b) Change the Rate.
 - c) Change delivery options, such as volume limit or bolus dose.
 - d) Clear TVD

MAKING CHANGES DURING DELIVERY

Below is an illustration of a delivery screen. There are six options available during any standard infusion. While running an infusion, you may:

- *Lock the keypad.*
- *Change the Dosage Rate.*
- *Titrate the Rate.*
- *Clear TVD*
- *Press the Bolus button to set, change, or deliver a bolus.*
- *Press the Stop button to pause or end the infusion delivery.*

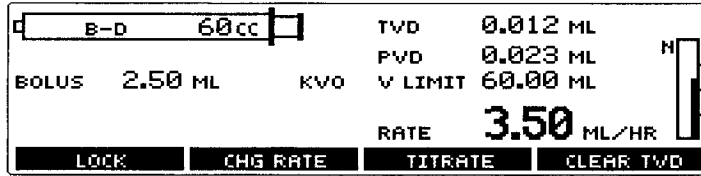

STOPPING DELIVERY

You can stop infusion delivery at **any time**, in any delivery mode.

1. Press the **Stop** button.
2. The infusing indicators turn OFF and the pump pauses. You may restart infusion, or change settings and restart. Or turn OFF the pump.

TURNING OFF THE PUMP

You can turn off the pump at **any time**, in any delivery mode, while the pump is running.

1. Press and hold the **Power** button. This calls the SHUTDOWN OR CONTINUE screen. Infusion has not stopped at this point.

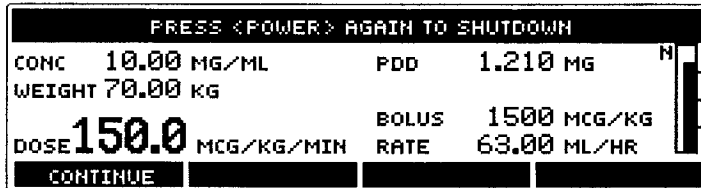

2. Press and hold the **Power** button to turn OFF the pump. To cancel press the **Continue** or **Back** buttons.
3. Infusion stops when you turn OFF the pump.

PROGRAMMING DELIVERY MODES

The **3010 and 3010a** infusion pumps come with a variety of delivery modes ready for you to program to meet your specific patient care needs. In fact, all modes are customizable by the user. The actual modes available in a given pump, and their location on a given screen, depend on the custom setup performed by your in-house technician, or service representative.

The following modes described in this chapter, and the steps given for programming them, are based on general setup parameters.

OVERVIEW OF PROGRAMMING STEPS

This chapter describes the basic steps for programming the different delivery modes. However, there is a difficulty in describing these steps for an “average user”. This is caused by the *extensive customization* available in the **3010 and 3010a** infusion pumps.

APPARENTLY MISSING OR DIFFERENT STEPS

As you learn to program infusion deliveries on your infusion pump, you may find that certain features or screens do not appear when you program a delivery mode in your pump.

In an effort to simplify the use of this manual, all features were not enabled for the writing of this operation manual. What steps you actually pass through in programming a delivery depend entirely on which features have been either “*enabled*” or “*disabled*” in the custom configuration process. So if you are programming and you find a step not included in these directions, it is because the step describes a feature which has been *enabled* for your particular machine.

For a better understanding of the enabled or disabled features of your infusion pump, refer to the Configuration Manual and to the chapter titled “*Tables of Default Settings for Anesthesia, General, and NICU*”.

Both the **3010 and 3010a** are shipped with the standard default settings for “Anesthesia” units or departments. These may be unchanged in your pump. Or they may have been used as a foundation for configuring your pump to meet the specific needs of your unit, department, organization, or hospital.

A REPEATED WARNING

You will see the following warning placed repeatedly throughout the steps for programming and starting all of the infusion delivery modes.

Warning! Confirm All Settings	Before starting ANY delivery, ALWAYS confirm correctness of ALL infusion values you just set.
---	---

It is possible to fall into a pattern of expecting an infusion pump to function in a specific way. But each pump can be configured to be programmed differently. So a pump in one unit or department can be setup quite differently from one in the next unit or department ... or hospital.

You are responsible for always verifying the correctness of any infusion delivery you program and start.

CONTINUOUS MODE: ml/hr

Continuous infusion is programmed by setting a *flow rate in ml/hr*. Actual range limits for flow rate are determined by syringe size (see table in Appendix) or custom configured maximum rate. If needed, a volume limit, loading dose, or bolus dose can be set.

Neglected Pump Alarm	If you stop in the middle of a numerical entry, you will hear the "Neglected Pump" alarm. You can: <ul style="list-style-type: none"> ☞ Press the Alarm Silence button "🔔" to silence the alarm for another 30 seconds. ☞ Finish numerical entries and reach the BEGIN INFUSION screen with the normal alarm silence interval.
----------------------	---

1. Use the **number** buttons to set flow rate and decimal point. Press **Clear** to clear an entry. Press **Backspace** to erase a character. Press the **Enter** button to accept the setting.

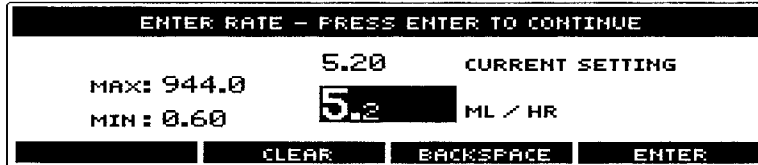

2. After all infusion values are set, the pump pauses at the BEGIN INFUSION screen.

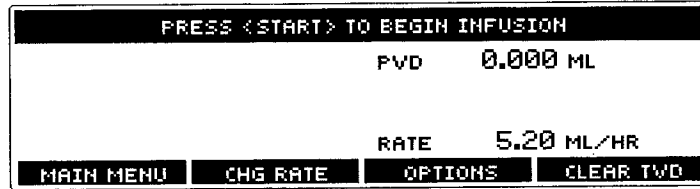

E-PLATES or MAIN MENU – returns you to the beginning of setup.
 CHG RATE – allows modifying the set rate without starting from scratch.
 OPTIONS – lets you select from a list of variables (e.g., bolus, or volume limit).
 CLEAR TVD – lets you clear total volume delivered.

3. You may now accept the settings and start the infusion, or use the four menu buttons to modify the settings.
4. Prior to beginning the infusion, press <BOLUS> to initiate the priming sequence (page 26).
5. When ready, press the **Start** button to begin infusion.

MASS MODES: MG/MIN – MG/HR – MCG/MIN – MCG/HR – MU/MIN – MU/HR – U/MIN – U/HR

This *Mass Mode* is a continuous infusion mode you program by setting:

- Drug concentration (i.e., mg/ml or U/ml).
- Dose rate in mass/hr (e.g., mg/hr or µg/min).
- You can also set volume limit, loading dose, or bolus dose.

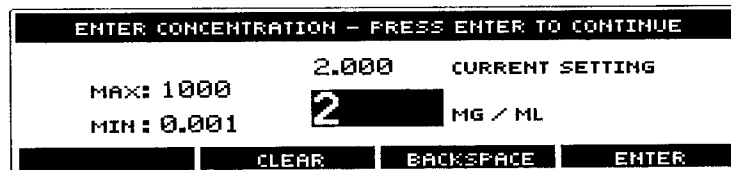

CLEAR – deletes an entry. BACKSPACE – deletes a character backward.

1. Use the number buttons to set the fluid concentration. Concentration is limited to 4 digits.
2. When ready, press the **Enter** button to accept the concentration value and go to the **ENTER DOSE** screen.

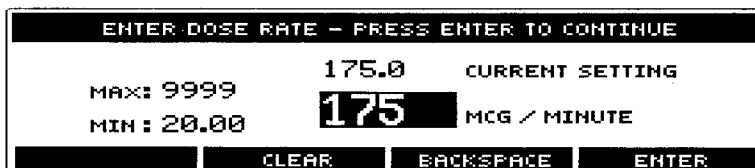

3. Use the number buttons to set **dosage rate**. Range limits for dose rate are determined by syringe size. The maximum and minimum rates display onscreen.
4. When ready, press the **Enter** button to go to the **BEGIN INFUSION** screen.
5. At the **BEGIN INFUSION** screen all values are set and the pump pauses.
6. You may now accept the settings and start the infusion, or use the four menu buttons shown below to modify the settings.
7. Prior to beginning the infusion, press <BOLUS> to initiate the priming sequence (page 26).

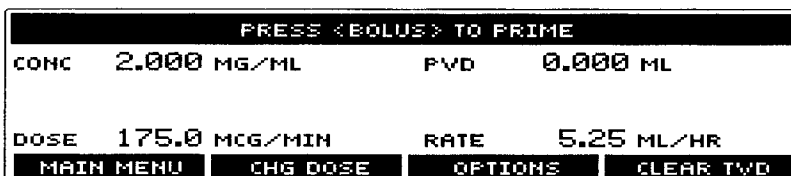

E-PLATES or MAIN MENU – returns you to the beginning of setup.
E-PLATES – When present, indicates E-Plates are enabled & returns you to beginning of setup.
CHG DOSE – allows modifying the set dosage without starting from scratch.
OPTIONS – lets you select from a list of variables (e.g., bolus, or volume limit).
CLEAR TVD – lets you clear total volume delivered.

When all delivery settings are correct, press the **Start** button to begin infusion.

BODY WEIGHT INFUSION DELIVERIES: MCG/KG/MIN – MCG/KG/HR – MG/KG/MIN – MG/KG/HR

The body weight rate calculation allows programming by:

- *Drug Concentration*
- *Patient's Weight*
- *Drug Dosage*

The pump calculates the correct flow rate in ml/hr to achieve the required drug dose. If desired, a volume limit, loading dose, or bolus dose can be set. From the SELECT THE MODE screen select the desired Body Weight Delivery Mode. These directions use select MICROGRAMS / KG / MINUTE as an example. This calls the ENTER CONCENTRATION Screen.

1. Press the **number** buttons to set medication concentration. Concentration is limited to 4 digits.

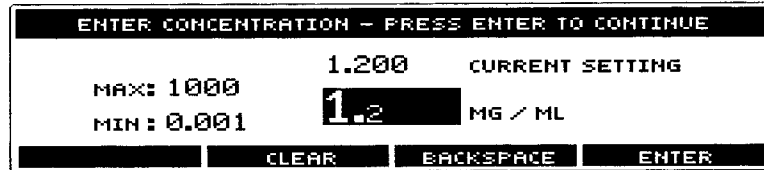

2. Press the **Enter** button to accept the concentration setting and go to the PATIENT WEIGHT screen.

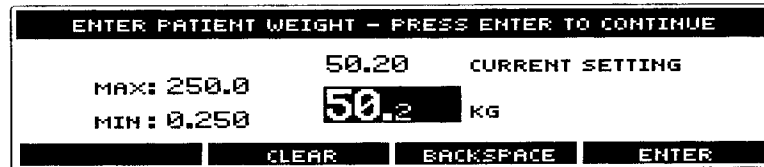

3. At the PATIENT WEIGHT screen, press the **number** buttons to set the patient's weight in kilograms. Weight is limited to indicated range.
4. Press the **Enter** button to accept the patient weight setting and go to the DOSE RATE screen.

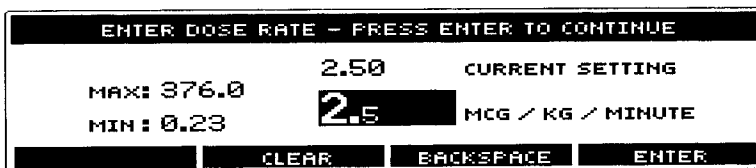

5. At the DOSE RATE screen, press the number buttons to set the dose rate. Range limits here for dose rate are determined by installed syringe size.
6. When ready, press the **Enter** button to accept the dosage rate go to the BEGIN INFUSION screen. Confirm all settings are correct.
7. Prior to beginning the infusion, press <BOLUS> to initiate the priming sequence (page 26).
8. You may now accept the settings and start the infusion, or use the four menu buttons to modify the settings. When ready, press the **Start** button to begin the infusion.

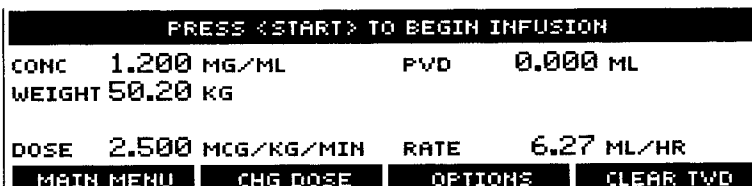

VOLUME / TIME – ml/hr

The volume over time rate calculation allows programming by:

- *Dose Volume*
- *Delivery Time*

The pump calculates the correct flow rate by dividing the volume by the delivery time. Volume limit, loading or bolus dose can **not** be set in this mode. Find and select VOLUME / TIME from the SELECT THE MODE screen. You may have to press the **More** button to find it.

1. When ready, press the **Enter** button to accept the syringe. This calls the VOLUME TO INFUSE Screen.

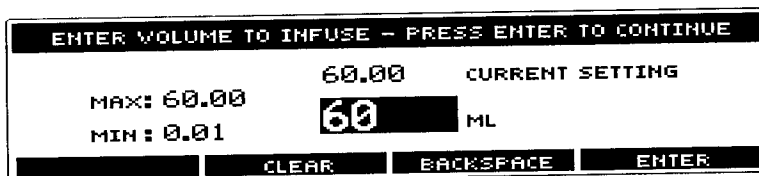

2. At the VOLUME TO INFUSE screen, press the number buttons to program the volume setting. Volume is limited to the *maximum fill volume for the syringe size – and minimum volume is 1/100th of the selected syringe size.*
3. When ready, press the **Enter** button to go to the DELIVERY TIME screen.



4. At the DELIVERY TIME screen press the **number** buttons to set delivery time. Time is always limited by maximum and minimum rates for selected syringe size.

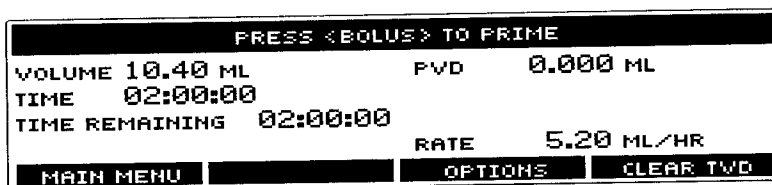

5. When ready, press the **Enter** button to accept the setting to go to the BEGIN INFUSION screen.

6. All settings are made, and the pump pauses at the BEGIN INFUSION screen. Confirm all settings are correct. You may now accept the settings and start the infusion, or use the four menu buttons to modify the settings.
7. Prior to beginning the infusion, press <BOLUS> to initiate the priming sequence (page 26).
8. When ready, press the **Start** button to begin the infusion.

INTERMITTENT VOLUME / TIME

This *Intermittent Volume / Time Mode* lets you specify a delivery volume for a specific delivery time, after which the delivery stops for a programmed interval ... then the pattern recycles. In other words, the pump delivers for a set period, then pauses a set period, then infuses for a set period, and so on.

- The *delivery stop interval* equals “Time Between Starts” minus “Delivery Time.”
- The pattern *repeats* at “Time Between Starts” interval.

Below are the steps for programming an Intermittent Volume / Time infusion. Select INTERMITTENT VOLUME / TIME from the SELECT THE MODE screen. This calls the VOLUME TO INFUSE screen.

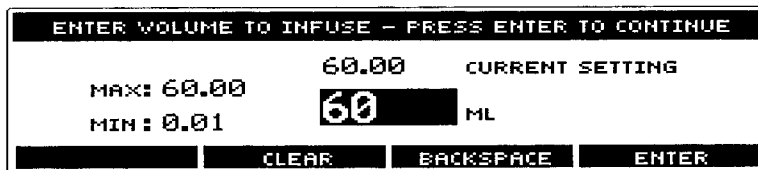

1. Use the **number** buttons to set the volume. Volume here is limited to the maximum fill volume for the syringe size, and minimum volume is 1/100th of syringe size.
2. When ready, press the **Enter** button to accept the VOLUME TO INFUSE setting, and call the DELIVERY TIME screen.



- Use the **number** buttons to type in the DELIVERY TIME setting. Maximum and minimum times are calculated for the syringe you are using. When ready, press the **Enter** button to call the TIME BETWEEN STARTS screen.



- Use the **number** buttons to set the TIME BETWEEN STARTS value. Time must be greater than delivery time and less than or equal to 24 hours. When ready, press the **Enter** button to accept the setting go to the BEGIN INFUSION screen.

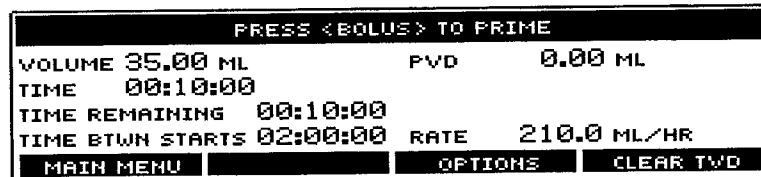

- All settings are made, and the pump pauses at the BEGIN INFUSION screen. Confirm all settings are correct. You may now accept the settings and start the infusion, or use the four menu buttons to modify the settings.
- Prior to beginning the infusion, press <BOLUS> to initiate the priming sequence (page 26).
- After confirming all settings are correct, press **Start** to begin intermittent volume / time infusion.

RECALL LAST SETTINGS

The **3010 and 3010a** remember the settings used to run the last infusion indefinitely (or at least 10 years). This means you can reuse the same delivery settings to repeat an identical dosage of medication or fluids to a patient.

1. You may reuse the last settings by selecting RECALL LAST SETTINGS from the SELECT THE MODE screen. (If you don't see it, press the **More** button and search for it.)

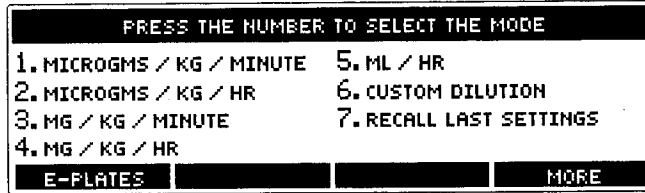

2. When selected, you must then press the **Enter** button to confirm data for each screen that applies for the last infusion. This includes all settings and options. The actual screens that appear depend on how your pump is configured and which features are enabled or disabled.

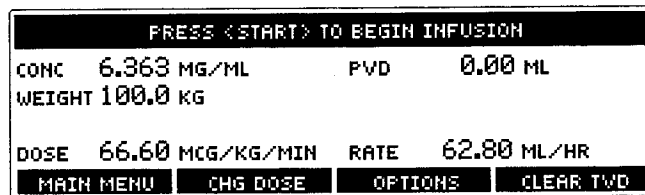

3. After reviewing these previously used settings, the pump pauses.
4. If you wish to clear the TVD, press the <CLEAR TVD> button
5. Prior to beginning the infusion, press <BOLUS> to initiate the priming sequence (page 26).
6. Be sure all pump settings are correct before starting infusion.

TVD and PVD / PDD Retention	The pump also retains TVD and PVD or PDD from the last infusion. If you <u>do not</u> want to use these values, you must manually clear them before beginning a new infusion.
------------------------------------	---

CUSTOM DILUTION

The *Custom Dilution* mode is a form of body weight delivery where you tell the pump a target delivery rate and the pump calculates the custom drug dilution to meet that target. The settings required are:

- a) *Initial (undiluted) drug concentration*
- b) *Patient's weight*
- c) *Target dose rate*
- d) *Target total volume (medication plus diluting fluid).*

From this data, the pump then calculates:

- a) *Amount of fluid required to dilute the initial drug concentration*
- b) *Actual dose rate*
- c) *Actual total volume (as close to target rate & volume as possible by rounding dilution).*

Reasonable Dilution Range	You must use a volume of diluent <i>20 ml or larger</i> to give reasonable range for dilutions.
Enable / Disable Custom Dilution	If you do not see CUSTOM DILUTION, nor any of these listed on the SELECT THE INFUSION UNITS screen for Custom Dilution, you must enable them through custom configuration.

TYPES OF CUSTOM DILUTION AVAILABLE

There are four different types of custom dilution infusion available in the **3010 and 3010a** infusion pumps.

Dilution Mode	What the Pump does
Micrograms / Kilogram / Minute	Calculates <i>micrograms</i> of medication or fluid per <i>kilogram of patient body weight</i> per <i>minute</i> of infusion to determine the mixing formula.
Micrograms / Kilogram / Hour	Calculates <i>micrograms</i> of medication or fluid per <i>kilogram of patient body weight</i> per <i>hour</i> of infusion to determine the mixing formula.
Milligrams / Kilogram / Minute	Calculates <i>milligrams</i> of medication or fluid per <i>kilogram of patient body weight</i> per <i>minute</i> of infusion to determine the mixing formula.
Milligrams / Kilogram / Hour	Calculates <i>milligrams</i> of medication or fluid per <i>kilogram of patient body weight</i> per <i>hour</i> of infusion to determine the mixing formula.

CALCULATING DILUTIONS FOR: MCG/KG/MIN – MCG/KG/HR – MG/KG/MIN – MG/KG/HR

This custom dilution mode calculates a mixing formula for dilutions of drug to reach a target dose rate for a given volume of fluid to be delivered.

1. At the SELECT THE INFUSION screen, use the **number** buttons to select delivery mode **Micrograms/ Kg/ Minute**, **Micrograms/ Kg/ Hour**, **Milligrams/ Kg/ Minute**, or **Milligrams/ Kg/ Hour**. This calls the TARGET RATE screen.

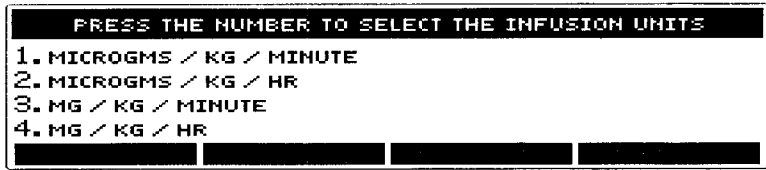

2. Use the **number** buttons to set the desired target infusion rate. The target rate should be based from the desired volume that you wish to give the patient over a given time. Syringe size limits the range of infusion rates.

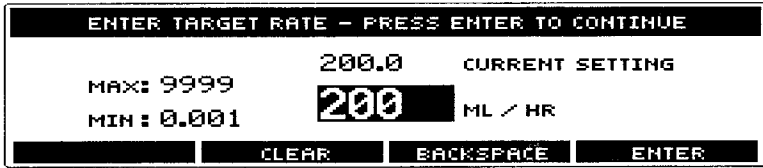

3. When ready, press the **Enter** button to accept the target rate setting, and go to INITIAL CONCENTRATION screen.

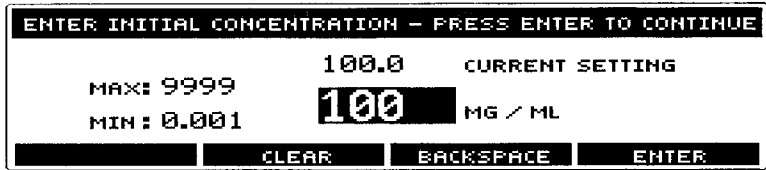

4. At the INITIAL CONCENTRATION screen, set the value for initial or *undiluted* drug concentration. You are limited to 4 digits. When ready, press the **Enter** button to accept this value and go to the PATIENT WEIGHT screen.

- At the PATIENT WEIGHT screen, set the patient's *weight in kilograms* (2.2 lbs/kg). Weight is limited to the range indicated. Press the **Enter** button to accept the value and go to the set target DOSE RATE screen.

ENTER PATIENT WEIGHT - PRESS ENTER TO CONTINUE		
MAX: 250.0	66.60	CURRENT SETTING
MIN: 0.250	66.6	KG
CLEAR	BACKSPACE	ENTER

- Use the **number** buttons to enter the desired target dose rate. The target dose rate is the desired rate for infusion of diluted drug into the patient. Units for this dose rate were set in the SELECT THE INFUSION screen. When ready, press the **Enter** button to accept the value and go to the set FINAL VOLUME screen.

ENTER DOSE RATE - PRESS ENTER TO CONTINUE		
MAX: 9999	100.0	CURRENT SETTING
MIN: 0.001	100	MCG / KG / MINUTE
CLEAR	BACKSPACE	ENTER

- Use the **number** buttons to set the FINAL VOLUME to be infused. This can go to only one decimal place, and final volume must be *equal-to-or-less-than* the maximum fill volume of the syringe being used.

ENTER FINAL VOLUME - PRESS ENTER TO CONTINUE		
MAX: 250.0	60.00	CURRENT SETTING
MIN: 20.00	60	ML
CLEAR	BACKSPACE	ENTER

- When ready, press the **Enter** button. The pump calculates the formula for the Custom Dilution and displays it onscreen.

PRESS CONTINUE WHEN READY		
MIX	1.00	ML OF DRUG
WITH	59.00	ML OF DILUENT
TO ACHIEVE A FINAL VOLUME OF 60.00 ML		
		CONTINUE

- Using aseptic techniques, prepare the dilution with this formula. Fill the syringe. Load syringe onto the infusion pump (see "Syringe Loading").

Warning! Fluids Compatibility	Always confirm compatibility between drug and diluent. Verify that the actual dose & delivery rates are acceptable settings. Actual rate may differ from target rate because of "rounding" of volumes in the dilution formula.
--	---

- When ready, press the **Continue** button to call the SELECT SYRINGE MANUFACTURER screen. Now you will complete setup of the pump and begin infusion.



- At the SELECT SYRINGE MANUFACTURER / TYPE screen, select the syringe you are using, then load the syringe. Step through the remaining levels, pressing the **Enter** button to verify each setting.
- After all values are confirmed, the pump pauses at the BEGIN INFUSION screen.
- Prior to beginning the infusion, press <BOLUS> to initiate the priming sequence (page 26).
- When ready, press the **Start** button to begin infusion.

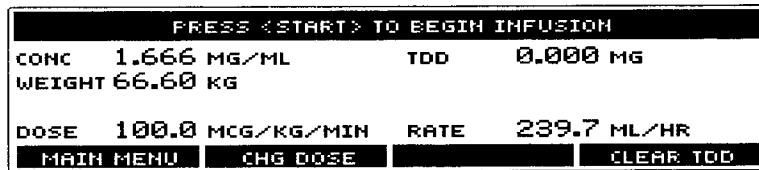

BOLUS DOSING

A *Bolus* dose is an optional parameter of some delivery modes wherein you specify a bolus volume to be delivered over a specified time. You may also configure bolus dose to be automatically “prompted” or called up in the programming steps.

Enable / Disable Bolus	You can permanently disable Bolus programming through pump custom configuration, or temporarily through the BOLUS DOSE screen. .
-------------------------------	--

SETUP BOLUS DOSING

Below are the steps for adding a bolus dosing to an infusion you are about to begin, or to one you have paused to include a bolus:

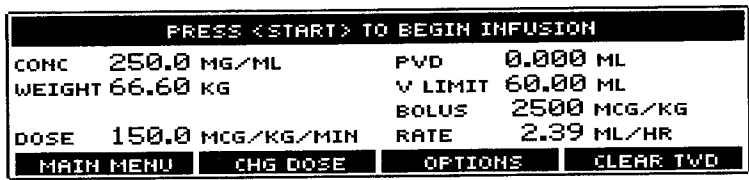

- When paused at the BEGIN INFUSION screen, press the **Options** menu button to find bolus dose programming.

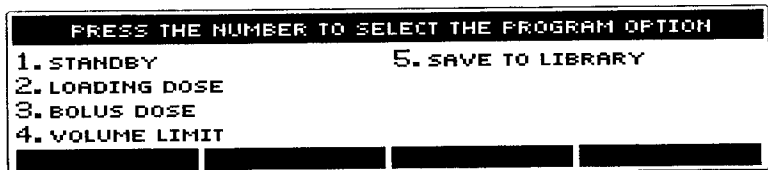

- Select bolus dose programming by pressing its **number** button. This calls the ENTER BOLUS DOSE screen.

- Use the **number** buttons to set the bolus volume desired for this infusion. Volume is limited to the maximum fill volume of the current syringe size, and minimum volume is $1/400^{th}$ the syringe size.

ENTER BOLUS DOSE - PRESS ENTER TO CONTINUE			
MAX: 60.00	2.50	CURRENT SETTING	
MIN: 0.60	2.5	ML	
DISABLE	CLEAR	BACKSPACE	ENTER

Disable - turns Bolus OFF. Clear - deletes an entry. Backspace - erases a character.

- When ready, press the **Enter** button to accept the volume setting (or dose setting if in *body weight* or *mass* mode).
- At the BOLUS TIME screen, use the **number** buttons to set bolus delivery time in *minutes and seconds*. The default value for bolus delivery rate is set in custom configuration. Maximum & minimum time is calculated from the maximum & minimum rate for the syringe size you are currently using.

ENTER BOLUS TIME - PRESS ENTER TO CONTINUE			
MAX: 15:00	05:00	CURRENT SETTING	
MIN: 05:00	05:00	MIN : SEC	
	CLEAR	BACKSPACE	ENTER

- When ready, press the **Enter** button to accept the settings and go to the BEGIN INFUSION screen.
- After the setting bolus, the pump pauses. The Bolus setting now appears on the BEGIN INFUSION screen.

PRESS <START> TO BEGIN INFUSION			
	PVD	0.000 ML	
BOLUS	2.50 ML		
	RATE	3.50 ML/HR	
MAIN MENU	CHG RATE	OPTIONS	CLEAR TWD

Warning! Confirm All Settings	Before starting ANY delivery, ALWAYS confirm correctness of ALL infusion values you just set.
---	---

DELIVERING A BOLUS DOSE

A **bolus** is a specified volume (or dose) to be delivered over a specified, usually short, period of time. You must have started a delivery before you can deliver a bolus dose.

1. Press the **Bolus** button (the “◀” button next to **Start**) to call the BOLUS DELIVERY screen. A bolus delivery cannot be initiated until after you press the **Start** button to begin a programmed delivery.
2. Press **Yes** to begin bolus delivery.
 - Or press **No** to skip the bolus and return to the NORMAL DELIVERY screen.
 - Or press the **Chg Bolus** button to change the bolus settings.
 - *If you don't press ANY button for 30 seconds, the neglected pump alarm will call you back to the pump..*

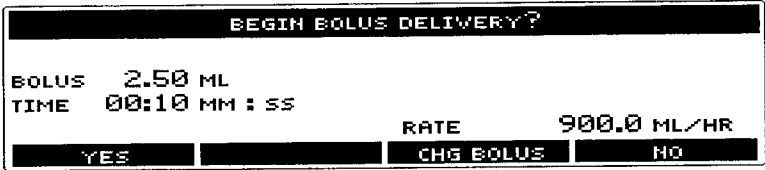

3. Pressing YES calls the BOLUS DELIVERY screen.

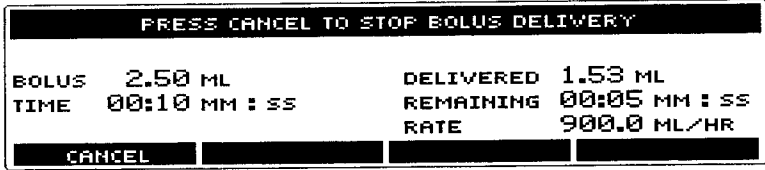

CANCEL – stops the bolus and returns to the normal delivery rate and screen.
 STOP – during a bolus delivery immediately halts all delivery and the pump pauses.

4. The bolus delivery continues at the bolus delivery rate until the bolus volume is delivered. On completion of bolus dosing ... the pump beeps, then resumes the programmed infusion delivery.

- The bolus volume delivered is automatically added to the Total Volume Delivered (TVD) as well as the Programmed Volume Delivered (PVD), or Programmed Dose Delivered (PDD) for that infusion.

LOADING DOSES

A *loading dose* is a specified volume (or dose) of drug infused as a one-time-only bolus prior to the start of normal delivery. You may also configure loading dose to be automatically “prompted” or called up in the programming steps.

Enable / Disable Loading Dose You can permanently enable / disable the *Loading Dose option* through custom pump configuration.

SETTING A LOADING DOSE

- When paused, press the OPTIONS menu button to find the loading dose feature.

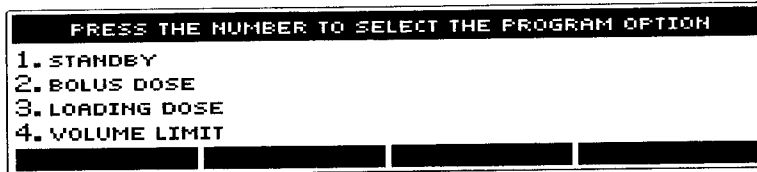

- Use the number buttons to call the ENTER LOADING DOSE screen.

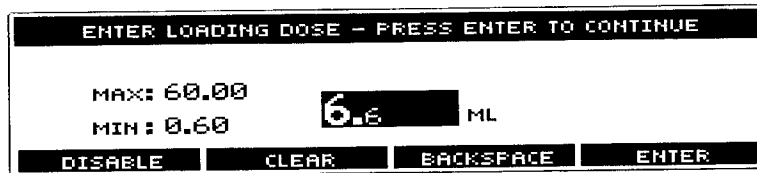

Disable – turns loading dose OFF. Clear – deletes an entry. Backspace – erases a character.

3. At the ENTER LOADING DOSE screen, set the loading dose volume. Here, volume is limited to the maximum fill volume for the current syringe size, and minimum volume is 1/400th of syringe size.
4. When ready, press the **Enter** button to accept the volume setting (or dose setting if in *body weight* or *mass* mode).
5. Use the number buttons to set delivery time in minutes & seconds. The default value for loading (i.e. bolus) delivery rate is set in custom configuration. Maximum & minimum time is calculated from the maximum & minimum rate for the syringe size you are currently using.

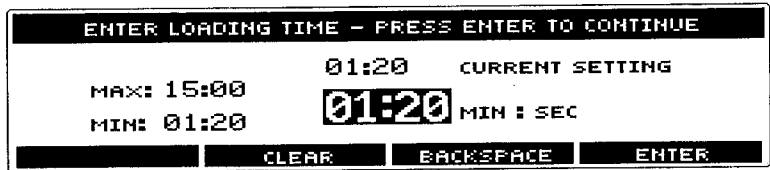

6. After the loading dose is set and accepted, the pump pauses at the BEGIN INFUSION screen. The Loading Dose setting now appears onscreen.



Warning! Confirm All Settings	Before starting ANY delivery, ALWAYS confirm correctness of ALL infusion values you just set.
---	---

DELIVERING A LOADING DOSE

After the loading dose is set, the pump pauses on the BEGIN INFUSION screen. The Loading Dose setting now appears onscreen.

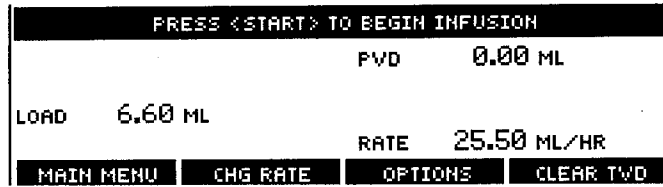

- When ready, press the Start button to begin infusion. The BEGIN LOADING DOSE screen appears.
 - Press **Yes** to confirm and begin loading dose delivery.
 - Press **Chg Dose** button to change the loading dose settings.
 - Press **No** to skip the loading dose and return to the NORMAL DELIVERY screen.
 - If you don't press ANY button for 30 seconds, the neglected pump alarm will call you back to the pump.*

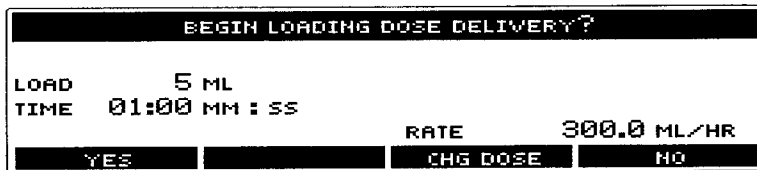

- Pressing **Yes** calls the LOADING DOSE DELIVERY screen and begins the infusion. The pump automatically completes the Loading Dose, then switches to normal delivery rate and screen. The loading dose volume delivered is automatically added to the Total Volume Delivered (TVD) as well as the Programmed Volume Delivered (PVD), or Programmed Dose Delivered (PDD) for that infusion.

CANCEL – stops the loading dose and returns to the normal delivery rate and screen.

PRESS CANCEL TO STOP LOADING DOSE DELIVERY			
LOAD	5.00 ML	DELIVERED	0.14 ML
TIME	01:00 MM : SS	REMAINING	00:59 MM : SS
		RATE	300.0 ML/HR
CANCEL			

STOP – during a loading dose delivery immediately halts all delivery and the pump pauses.

VOLUME LIMIT

A *Volume Limit* is an **Option** available for most delivery modes (except *volume/time* and *intermittent*). On reaching the preset volume limit, the pump stops – or changes to KVO if a keep vein open rate has been programmed.

Volume limit is based on the quantity of programmed volume delivered.

Enable / Disable Volume Limit	If <i>Volume Limit Dosing</i> is not currently available as a dosing option, you can enable it through custom pump configuration.
--	---

SETTING VOLUME LIMIT

You can set a volume limit either before starting an infusion, or by pausing the pump during an infusion. Volume limit is found on the OPTIONS screen, which you select from the BEGIN INFUSION screen.

PRESS <START> TO BEGIN INFUSION			
BOLUS	2.50 ML	PVD	0.021 ML
		V LIMIT	60.00 ML
		RATE	3.50 ML/HR
MAIN MENU	CHG RATE	OPTIONS	CLEAR TWD

1. When pump is paused, press the **Options** button to find the volume limit feature.

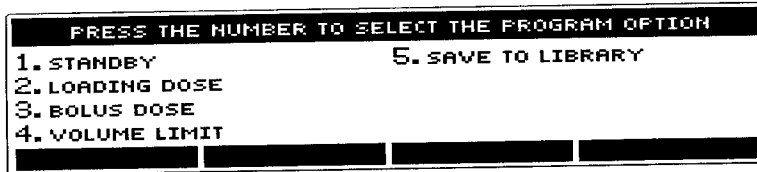

2. Press the **number** button for volume limit to call the ENTER VOLUME LIMIT screen.

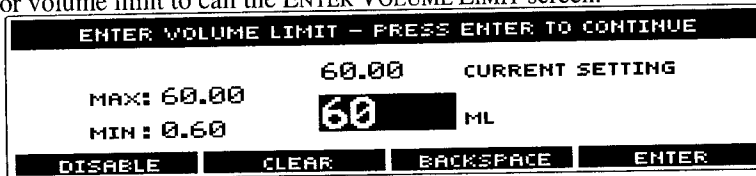

3. Use the **number** buttons to set the volume limit. Volume is limited to the maximum fill volume for the current syringe size, and minimum volume is 1/100th the syringe size. **Disable** – turns Volume Limit OFF. **Clear** – deletes an entry. **Backspace** – erases a character.

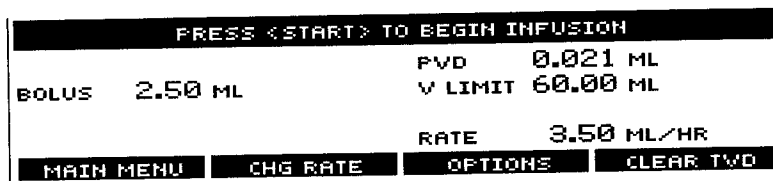

- When ready, press the **Enter** button to accept the settings and call the BEGIN INFUSION screen.
- With the volume limit set, the pump pauses at the BEGIN INFUSION screen. The volume limit setting now appears on the display. Program Volume Delivered (PVD) will appear on the screen directly above the V LIMIT.
- If you are initiating a new infusion, Prior to beginning the infusion, press <BOLUS> to initiate the priming sequence (page 26).
- When ready, press **Start** to begin infusion. The infusion will stop when it reaches the preset volume limit.

Warning! Confirm All Settings	Before starting ANY delivery, ALWAYS confirm correctness of ALL infusion values you just set.
---	---

KEEP VEIN OPEN (KVO) RATE

The *Keep Vein Open (KVO)* rate is an **Option** available for most delivery modes (except *volume/time* and *intermittent volume/time*).

- You must have a *volume limit* programmed for KVO to work. After a volume limit is reached, a low rate (KVO) is set to maintain patency of the infusion site.
- The range of rates available appears on the ENTER KVO RATE screen. KVO rates are calculated by syringe size and its minimum flow rate.
- The programmed KVO rate must be *less than* the normal delivery rate and *greater than or equal to* minimum flow rate for the syringe. **The pump will begin infusing, once the volume limit has been reached, at either the programmed KVO rate or the current infusion rate, which ever is less.**

Enable / Disable KVO dosing	KVO dosing can be enabled or disabled through custom configuration pump.
-----------------------------	--

PROGRAMMING KVO RATE

1. You can set a KVO rate at the BEGIN Infusion screen, either before starting an infusion, or by pausing the pump during an infusion. You can find it by pressing the OPTIONS button on the BEGIN INFUSION screen.

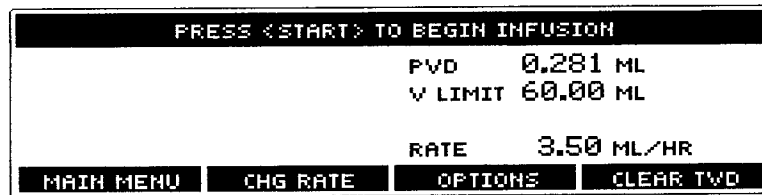

2. When pump is paused, press the **Options** button to call the SELECT THE PROGRAM OPTION screen.

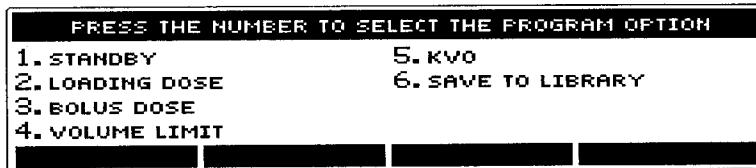

3. Find the KVO option. Press its **number** button call the ENTER KVO RATE screen.

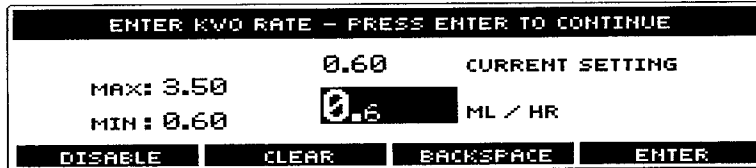

4. Use the **number** buttons to set the KVO rate within the minimum and maximum rates onscreen.

5. When ready, press the **Enter** button. After the KVO setting is complete, the pump pauses. The KVO setting now appears on the BEGIN INFUSION screen

6. If you are initiating a new infusion, Prior to beginning the infusion, press <BOLUS> to initiate the priming sequence (page 26).

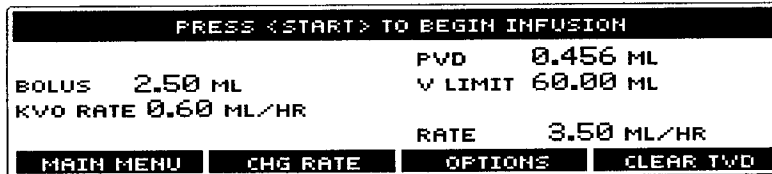

7. When ready, press the Start button to begin the infusion.

Warning! Confirm All Settings	Before starting ANY delivery, ALWAYS confirm correctness of ALL infusion values you just set.
---	---

DELIVERY AT KVO RATE

The *keep vein open* feature is intended for use when you are delivering a series of infusions to a patient, and wish to ensure the delivery site remains patent between the end of one infusion and the beginning of the next.

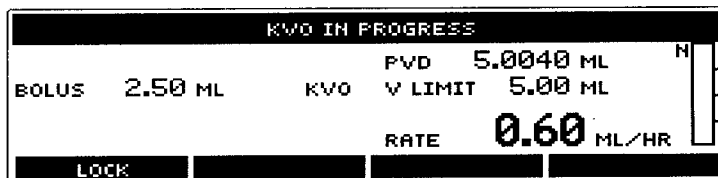

1. Set the delivery mode you want to use for infusion.
2. Select and set the Volume Limit option.
3. Select and set the KVO option.
4. Press **Start** to begin an infusion.
5. Normal delivery ceases when the pump reaches the programmed volume limit. The pump then begins to infuse at the preset keep-vein-open (KVO) delivery rate , or the infusion rate at the time the volume limit is reached, whichever is less.
6. Here, the pump triggers a KVO alarm – informing you the infusion is complete & the pump is infusing at KVO rate.
7. KVO delivery terminates when the syringe is empty, or if you press the **Stop** button. When the pump automatically stops *keep vein open* infusion, it sounds a “syringe empty” alarm.

Stop KVO Infusion	You can stop a KVO infusion at any time by pressing the Stop button.
Silence KVO Alarm	You can silence the alarm by pressing the Alarm Silence button.

STANDBY

STANDBY is an **Option** that allows setting the pump for an infusion, then delaying advisory alarms for a programmed interval of time.

- The pump **does not automatically start** an infusion at the end of the standby.
- Instead, the pump triggers an alarm at the end of the standby period to tell you to either **Start** or **Cancel** the infusion.

Enable / Disable Standby The STANDBY option can be enabled / disabled through custom configuration

PROGRAMMING STANDBY

3. When the pump is paused at the BEGIN INFUSION screen, press the **Options** button to find the STANDBY utility.



4. Select STANDBY mode by pressing its **number** button.

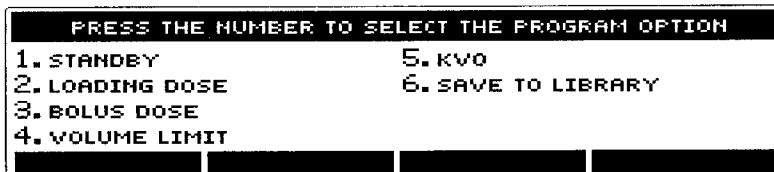

- Set standby time in *hours & minutes*. The maximum STANDBY setting is 24 hours. The default standby time is 1:00 Hr.

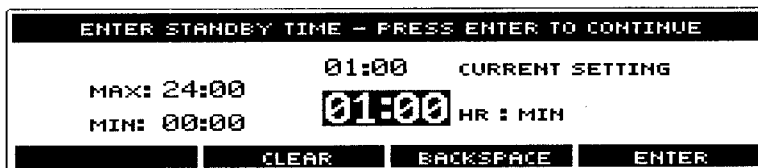

- When ready, press the **Enter** button to accept the standby setting and go to the BEGIN INFUSION screen.

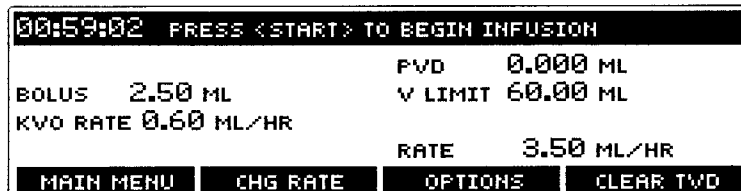

- The standby timer then appears in the upper left corner onscreen "*counting down*". All audible alarms are disabled for this interval. Standby continues until timer has counted to zero. You can discontinue standby mode at any time, by pressing the **Start** button, or by setting standby to zero.
- When the counter reaches zero, the pump sounds an alarm reminding you to begin the infusion.

DELIVERY

In DELIVERY, the pump infuses at the rate setting for the pump. The infusing indicators are illuminated, and the total volume delivered (or total dose delivered) accumulates.

STARTING DELIVERY

You can start the infusion at *any time* when the pump is on STANDBY or paused at BEGIN INFUSION screen.

1. To start infusion from standby or pause, press the **Start** button.
2. While you are running an infusion, you may:
 - a) Lock the keypad.
 - b) Change the Dosage Rate.
 - c) Titrate the Rate
 - d) Clear TVD.

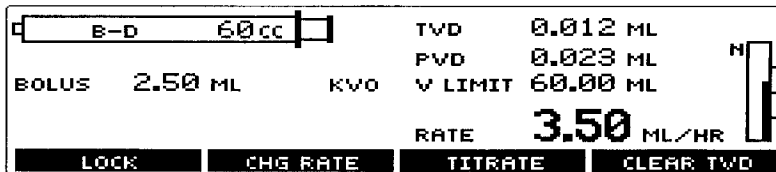

Volume / Time or Intermittent Volume / Time	In <i>Volume / Time Delivery</i> (and <i>Intermittent Volume / Time</i>), the screen indicates the effective delivery rate and time remaining to complete the infusion. Bolus, changing rate, and titrating rate, are <i>not allowed</i> in this delivery mode
---	---

STOPPING DELIVERY

You can stop infusion delivery at any time.

1. Press the **Stop** button.
2. The infusing indicators turn OFF and the pump pauses. You may:
 - a) Restart infusion at any time
 - b) Change settings and restart infusion.
 - c) Cancel the infusion by returning to the Main menu screen.
 - d) Turn off the pump.

OCCUSION TREND GRAPH DURING DELIVERY

The pump automatically monitors *occlusion* or syringe back pressure during any infusion. This trend appears in a *bar graph* on the right side of the display during delivery. The letter at the top of the graph indicates the configured occlusion alarm level:

Code	Meaning	Relative Pressure
VH	Fixed for 1cc syringe at <i>very high</i> (3010a only)	35 psi (248 Kpa)
H	<i>high</i>	16 psi (110 kPa)
N	<i>normal</i>	12 psi (83 kPa)
L	<i>low</i>	8 psi (55 kPa)
VL	<i>very low</i>	4 psi (28 kPa)

Pressures in above table are only approximations. This is because syringe friction affects the actual pressure level.

Occlusion limit default is set in the custom configurations (see Configuration Manual).

The operator may override the default Occlusion limit for a particular infusion from the <OPTIONS> menu if that option is enabled.

This bar graph indicates three pressure reading values:

1. The right side of the bar is the newest reading.
2. The left side of the bar is the oldest reading.
3. The update rate to the graphical readings depends on the flow delivery rate.

Therefore:

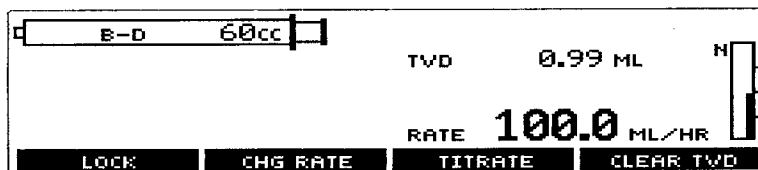

☞ If the graph slopes upward from left to right, then the pump is headed toward occlusion.

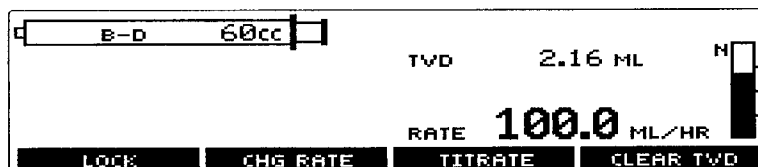

☞ If the graph is level, then back pressure is steady.

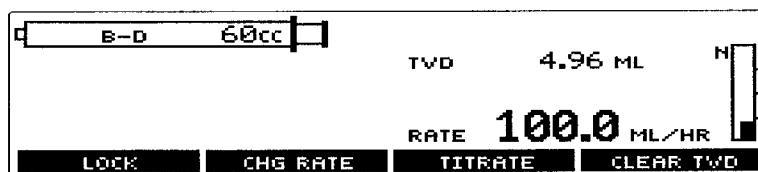

POST OCCLUSION BOLUS REDUCTION

With large syringes, Bolus can accumulate or be “stored” in the syringe tip when an occlusion happens. This pump contains an algorithm for *occlusion bolus reduction*.

Using occlusion bolus reduction, the pump withdraws the plunger a predetermined amount to reduce “stored” bolus in the syringe. However, this feature does not totally eliminate the occlusion bolus. Occlusion bolus will vary greatly with infusion setup and the fluid infused.

The chart below shows *typical* occlusion bolus volumes – *after bolus reduction* – for several syringes at different occlusion pressure settings. (Note: for syringes smaller than 10 cc, the occlusion bolus is very small.)

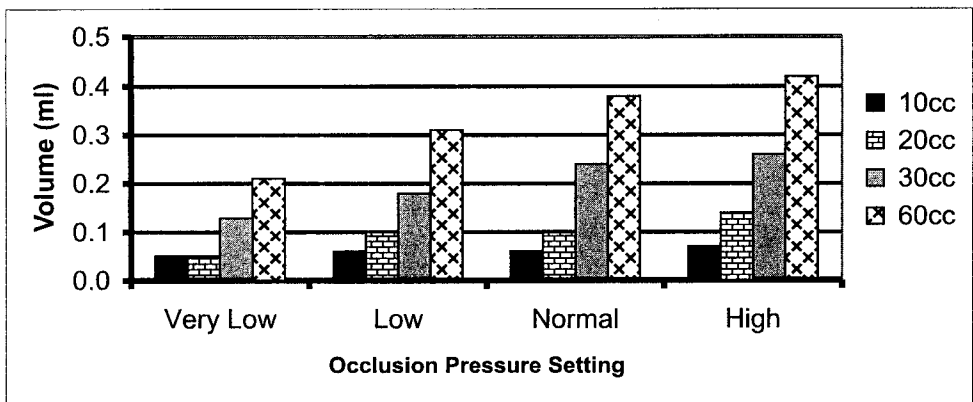

Typical occlusion bolus volumes for Becton-Dickinson 10, 20, 30, and 60 cc syringes.

TIME TO OCCLUSION

The time for the pump to detect an occlusion is affected by three factors:

1. Occlusion Pressure Setting – High (H), Normal (N), Low (L), or Very Low (VL).
2. Flow Rate Setting.
3. Syringe & Tubing Compliance, (i.e., softness of syringe plunger tip or tubing).

Below are typical time to occlusion graphs for several syringes. See guidelines for pump performance on time to occlusion. At lower rates smaller syringes have shorter occlusion times.

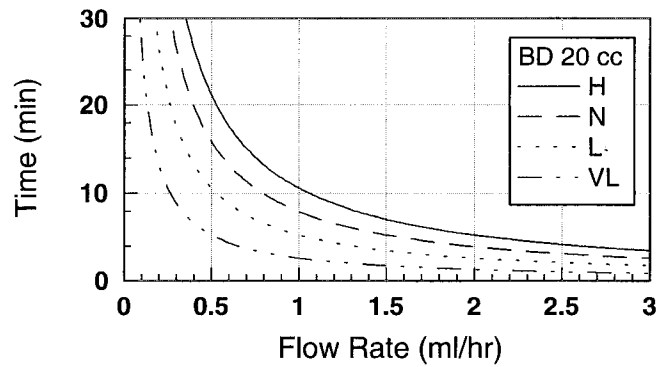
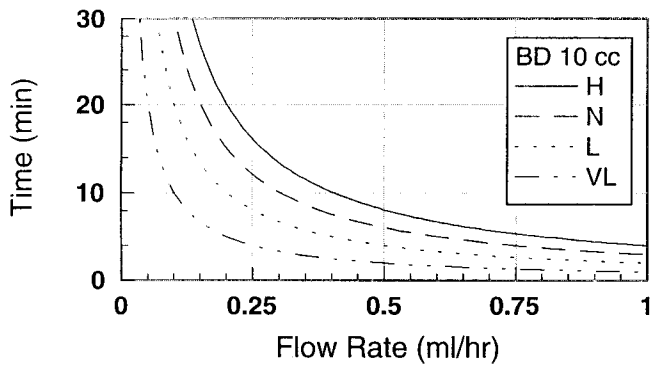
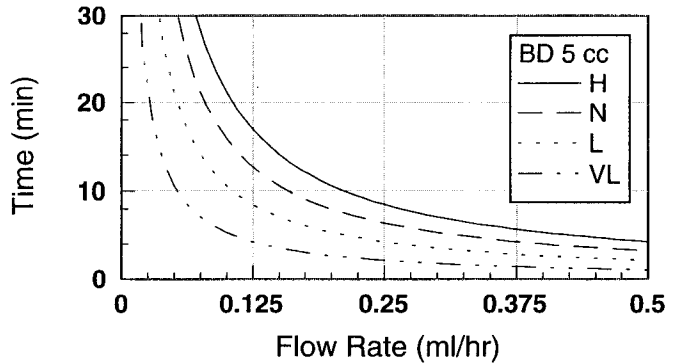
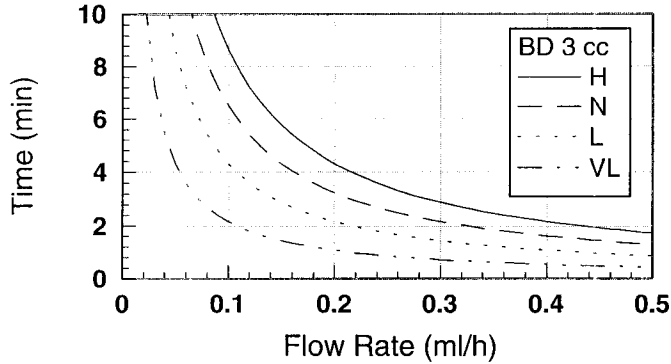

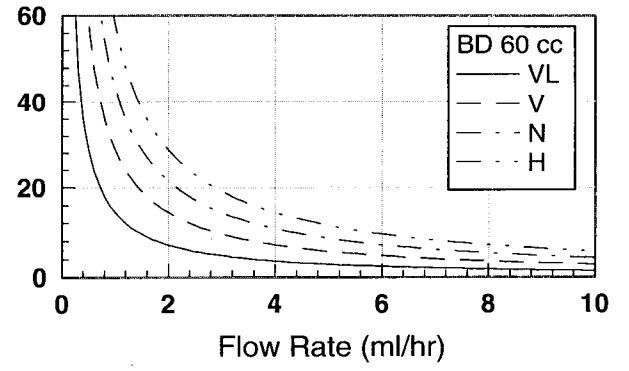
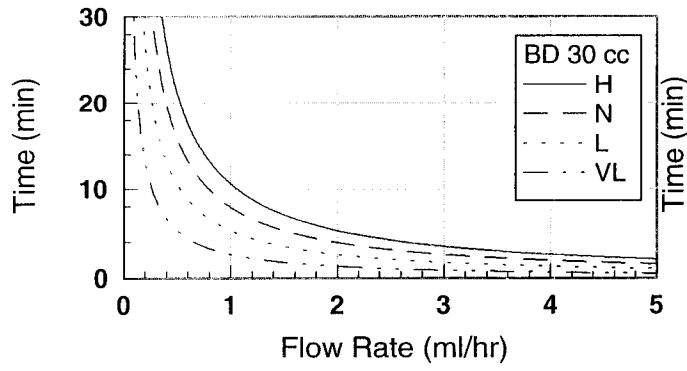

FLOW DELIVERY GRAPHS

This section contains the flow delivery graphs for selected B-D syringes.

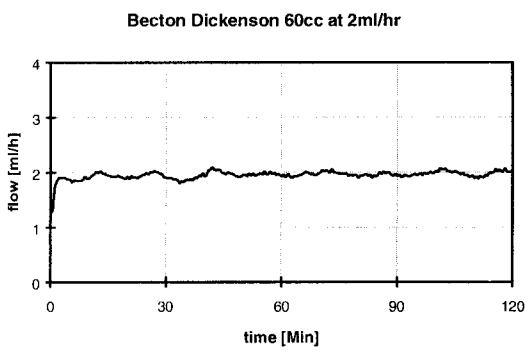

Startup graph for B-D 60 cc.

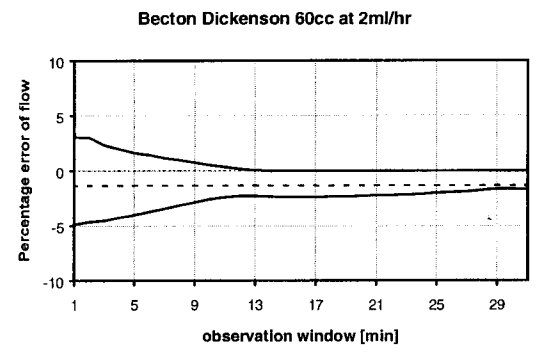

Trumpet curve for B-D 60cc.

Becton Dickenson 30cc at 1ml/hr

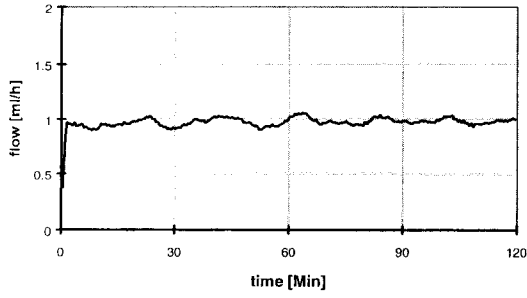

Startup graph for B-D 30 cc.

Becton Dickenson 30cc at 1ml/hr

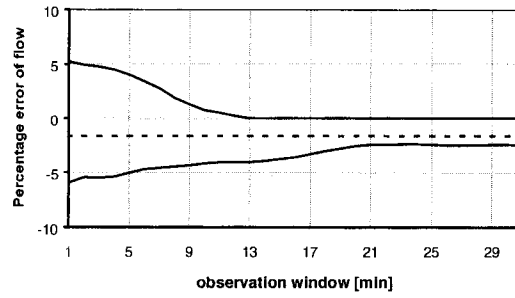

Trumpet curve for B-D 30 cc.

Becton Dickenson 5cc at .17ml/hr

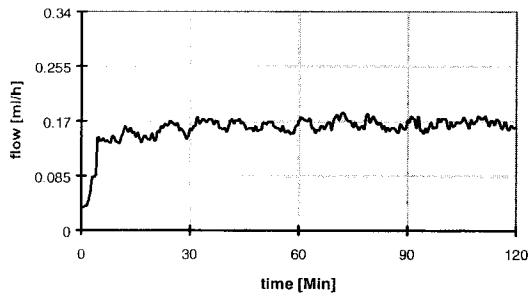

Startup graph for B-D 5 cc.

Becton Dickenson 5cc at .17ml/hr

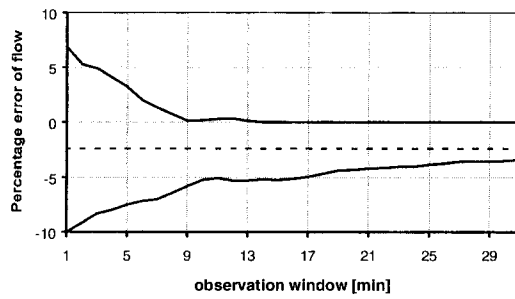

Trumpet curve for B-D 5 cc.

CHANGING DELIVERY RATE

The **3010 and 3010a** infusion pumps offer different ways of changing delivery rate, either before beginning infusion, during delivery, or when paused.

TITRATE RATE DURING DELIVERY

You can change the infusion rate by *titrating* the dosage **Up** or **Down** during infusion. Titration changes infusion rate by increasing or decreasing the current setting. The increments of change depend on syringe size & fluid concentration.

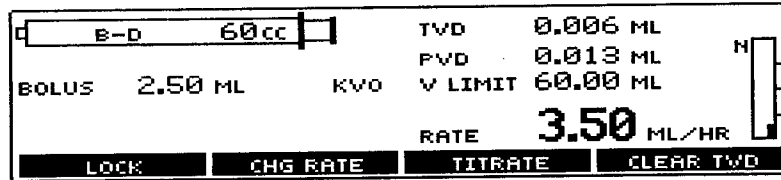

1. Press TITRATE button at DELIVERY screen. This calls the ADJUST THE RATE screen. **Infusion does not stop.**

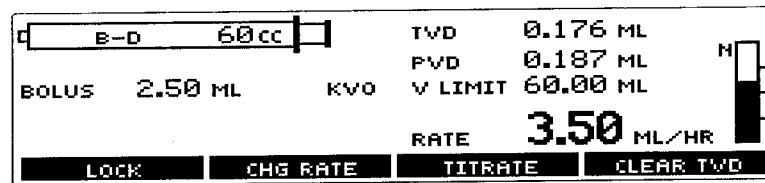

2. Press the “↑ or ↓” menu buttons to increase or decrease the setting.. Or use the **Back** button to escape without titrating.

Increments of Change	Increments of change are based on syringe size. The smaller the syringe installed on the pump, the smaller the available increments. The larger the installed syringe, the larger the increments.
-----------------------------	---

3. The *delivery rate does not change until you press* the **Enter** button. If you change your mind, press **Back** to return to DELIVERY screen without making a change. Rate is limited by the maximum and minimum delivery rate for the syringe size.

- When ready press the **Enter** button to accept the new setting. The new rate is not effective until you press the **Enter** button.

Titration Unavailable	Titration is unavailable for either VOLUME / TIME or INTERMITTENT modes.
-----------------------	---

CHANGING RATE DURING DELIVERY

You can change the infusion rate during any delivery session, except Volume/Time or Intermittent modes.

- To change the rate during delivery, press the **Chg Rate** (or **Chg Dose**) button.

E-D	60cc	TVD	0.334 ML	M	
BOLUS	2.50 ML	PVD	0.345 ML		
		KVO	V LIMIT 60.00 ML		
		RATE	3.50 ML/HR		
LOCK		CHG RATE		TITRATE	CLEAR TVD

- Use the **number** buttons to set the dose rate. Rate is limited by the maximum and minimum delivery rate for syringe size.

ENTER RATE - PRESS ENTER TO CONTINUE			
	3.50	CURRENT SETTING	
MAX: 944.0	3.5	ML / HR	
MIN: 0.60			
CLEAR		BACKSPACE	ENTER

- When ready press the **Enter** button to accept the new setting. The *pump delivery rate does not change until you press the Enter button*. If you change your mind, press **Back** to return to DELIVERY screen without making a change.

CHANGING RATE WHEN PAUSED

You can change the dosage rate at any time the pump is paused:

1. If the pump isn't already paused, then press the **Stop** button to pause the infusion.

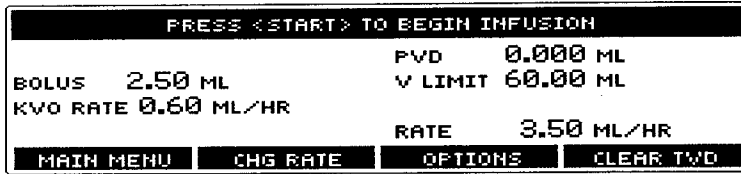

2. To change the rate during any pause, press the CHG RATE (or CHG DOSE) button.

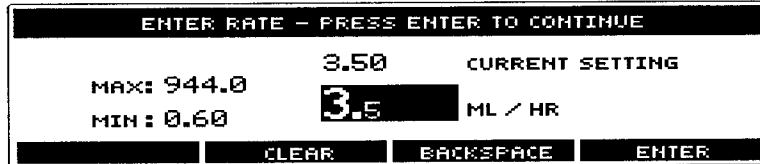

3. Use the **number** buttons to change the delivery rate. Rate is limited by the maximum and minimum delivery rate for syringe size.

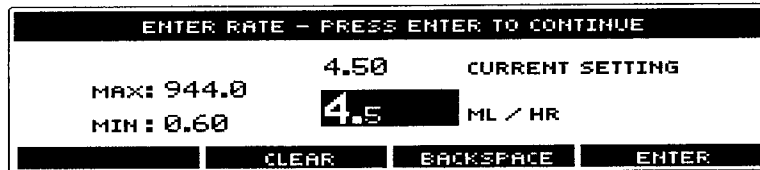

4. When ready press the **Enter** button to accept the new setting.
 - a) The delivery rate entry does not change until you press the **Enter** button.
 - b) You may exit without changing the rate by pressing the **Back** button.
5. The pump is paused at the BEGIN INFUSION screen. When ready, press the **Start** button to begin delivery.

TOTAL VOLUME, PROGRAM VOLUME / DOSE DELIVERED

The **3010 and 3010a** infusion pumps monitor and maintain the total quantity of fluids being delivered during any given session of infusions. Total Volume Delivered (TVD) is displayed at the top of the screen directly above the Program Volume Delivered (PVD) or Program Dose Delivered (PDD). The TVD is the total volume delivered to the patient and it will continue to accumulate until the Clear Totals program key is pressed or the pump is turned off.

DISPLAYING PROGRAM VOLUME DELIVERED / PROGRAM DOSE DELIVERED

In most delivery modes, you have the option of viewing either “*Program Volume Delivered*” or “*Program Dosage Delivered*”.

On the display, PVD or PDD accumulates as the volume or dose delivered to the patient while in the current programmed delivery. This display totals the boluses, loading dose, and normal delivery volumes.

PRESS <START> TO BEGIN INFUSION			
CONC	1.200 MG/ML	PVD	0.000 ML
WEIGHT	50.00 KG		
DOSE	2.500 MCG/KG/MIN	RATE	6.25 ML/HR
MAIN MENU	CHG DOSE	OPTIONS	CLEAR TVD

- ☞ **Priming volume** – which should never be delivered to the patient – **does not accumulate on this display.**
- ☞ **Program volume or dose delivered** – Appears on screen during DELIVERY and while the pump pauses
- ☞ **Toggle between PVD or PDD** – Available through OPTIONS menu when paused (provided this has been set).
- ☞ **Program Dose Delivered** – Only available when *concentration* has been programmed.

PRESS THE NUMBER TO SELECT THE PROGRAM OPTION			
1.	STANDBY		
2.	CHANGE TO TOTAL DOSE		

CLEARING TOTAL VOLUME, PROGRAM VOLUME, OR PROGRAM DOSE DELIVERED DISPLAY

Use the following steps to clear the total volume, and program volume or dosage and reset the counter to zero:

1. From any delivery or pause screen, press the **Clear Totals** program key.

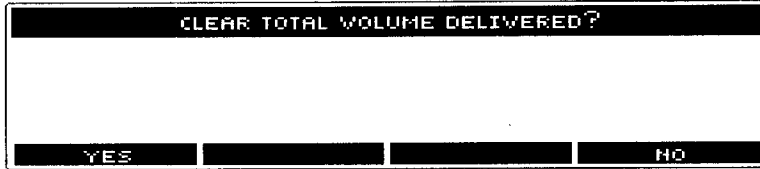

2. Confirmation is required to clear totals delivered.
3. Press **YES** to clear total volume delivered. Or press **NO** to exit without clearing.
4. The *program volume (or dose) delivered is cleared automatically whenever the pump's delivery mode or syringe size is changed.* The Total Volume Delivered does not clear automatically.

Recovering TVD / TDD Information	You can restore total volume delivered display after turning OFF the pump by using the <i>Recall Settings</i> selection from the Main menu. If you have cleared the TVD, then only the quantity infused since clearing will be stored in memory.
---	--

KEYPAD LOCK

The keypad can be locked during delivery. The lock feature is provided to make the delivery settings tamper resistant. Once the system is locked, a setting cannot be modified until the system is unlocked.

☞ Press the **LOCK** button to lock the front panel controls. The **LOCK** indicator lights.

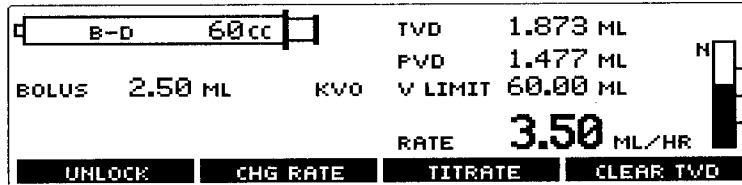

☞ If you press any front panel buttons other than the **UNLOCK** button, a “**PUMP IS LOCKED**” message appears onscreen.

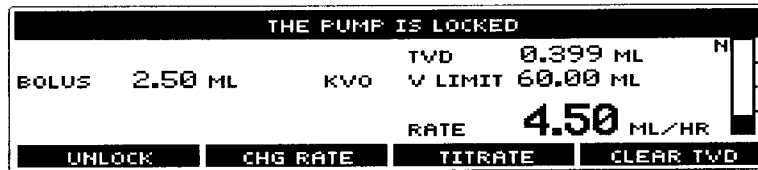

☞ Press the **UNLOCK** menu button to unlock the front panel.

- Any high-priority alarm automatically unlocks the front panel.

USER DEFINED LIBRARIES

This chapter describes the **3010 and 3010a** infusion pump “user defined libraries”, tells you how to use them, create and save them, and enable or disable their availability.

WHAT ARE LIBRARIES?

The pumps have 4 libraries containing as many as 16 entries per library. Each *library* is here defined as an electronic storage place for a group of preset infusion delivery values. Each group of preset values is a *user-programmable* “template”. A *template* is defined here as a stored record of infusion settings that load from memory. These templates are stored in memory indefinitely (over 10 years) or until overwritten.

FOR WHAT ARE LIBRARIES AND TEMPLATES USED?

Every unit, department, organization, or hospital has standard ways of delivering medications or fluids. If you use the pump on a regular basis, you will find yourself typing the same values again and again when preparing the pump for delivery. By using the libraries and templates feature, you can *make these settings once* and then *save those settings to a permanent file or template*.

These templates of *stored presets* are used for administering fluids or medications in standard infusions – without your having to setup individual dosage values each time you need to begin an infusion. So they are a means of automating the pump setup process.

WHO CAN USE THESE LIBRARIES OF TEMPLATES?

Anyone who is authorized to use the infusion pump can use templates in any of the 4 available libraries. Your facility should establish a policy for controlling setup, modification, and recording of libraries.

TYPES OF PROGRAMMABLE LIBRARIES

There are two types of libraries in the **3010 and 3010a** infusion pumps:

Type of Library	What It Does
E-Plates Library	The 1 st is the <i>E-Plates Library</i> . Like the standard libraries, they contain templates with presets necessary for programming an infusion. But they do not pause at each level for you to verify the settings. Instead, <i>the entire set of values is programmed at one step including syringe manufacturer and size</i> . Then the pump pauses at the BEGIN DELIVERY screen and displays all the infusion values. At that point, you merely have to press the Start button to begin delivery.
Standard Libraries	The last 3 are <i>Standard Libraries</i> and contain templates with presets necessary for programming an infusion. These libraries require you to step through and review each setting. This allows modifying standard settings while stepping through preset values.

LIBRARY AND TEMPLATE WARNINGS & CAUTIONS

<p>Warning! Confirm All Settings</p>	<p>Before starting ANY delivery, ALWAYS confirm correctness of ALL infusion values you just set.</p> <p>When using E-Plates, preset values are automatically inserted without pausing to verify each setting. You go directly to the BEGIN INFUSION screen where all the infusion values are displayed at once. Be sure to verify their correctness before starting the delivery.</p> <p>Extra caution should be exercised when using E-Plates. It is recommended each organization, unit, or department maintain a written logbook of the contents of every E-Plate, and have this logbook available as a reference resource for personnel using E-Plates in their daily operations.</p>
<p>Displaying E-Plate Options</p>	<p>The steps in this section are hypothetical. The 3010 and 3010a infusion pumps are shipped with all the libraries both blank and disabled. So the actual E-Plates you have available depend entirely on whatever E-Plates your system operator has programmed into your pump.</p>

USING "STANDARD" LIBRARIES

If a standard library *enabled*, the pump displays this library selection under the Main menu.

1. If you don't see a library listing on the SELECT THE MODE screen, press the **More** button to find it on another screen; otherwise it is necessary to enable that library using the custom configuration.

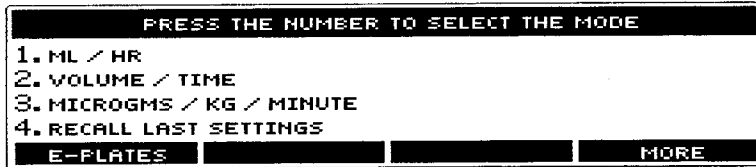

2. Select a library from the menu. For example: If "3" below is selected, then the LIBRARY C screen appears.

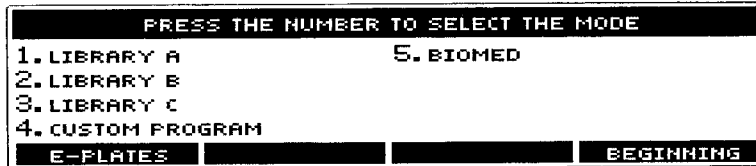

3. Select a LIBRARY ENTRY (template) by pressing its number.

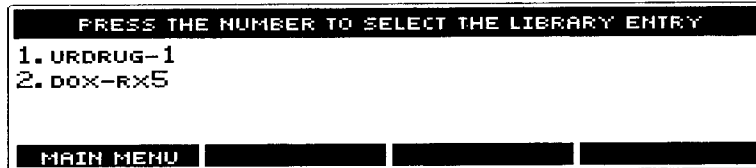

For example: If you select template "1" you get the presets for infusing URDRUG-1.

4. You are next prompted to load a syringe, then *confirm & accept each level of settings* by pressing the **Enter** button.
5. When all settings are confirmed, you go to the BEGIN INFUSION screen. Press **Start** to begin the infusion.

Warning! Confirm All Settings	Before starting ANY delivery, ALWAYS confirm correctness of ALL infusion values you just set.
---	---

HOW TO TELL WHETHER E-PLATES ARE ENABLED FOR USE

Medex ships the infusion pump with all the libraries disabled. Whether they are enabled on the pump you are using depends entirely on its custom configuration.

What actual E-Plates presets you have available depend on the configuration setup by the person responsible for custom configuration before the pumps were delivered to your work area.

You can tell whether E-Plates is enabled for use by *what you see onscreen when you start the pump*, or when you progress to the BEGIN INFUSION screen, or when you *return to the beginning screen*.

E-PLATES IS DISABLED

Below is the rule of thumb for determining whether the E-Plates library is disabled and not available for you to use:

☞ When E-PLATES is *disabled*, or there is no stored template in the library, the SELECT THE MODE menu is what you see onscreen after you turn on the pump and it completes its startup self-check. It will look something like the screen below:

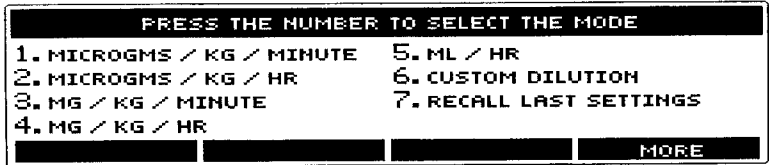

E-PLATES IS ENABLED

The infusion pump gives you visual cues when the E-Plates library is enabled. Below are some rules-of-thumb for determining whether the E-Plates library is enabled and ready for you to use:

☞ Normally ... the SELECT THE MODE screen is the first thing you see on screen after you turn on the pump and it completes its startup self-checks.

☞ But when E-PLATES is *enabled*, and there is a stored template in the E-Plates library, the SELECT THE LIBRARY ENTRY menu is the first thing you see on screen after you turn on the pump and it completes its startup self-checks.

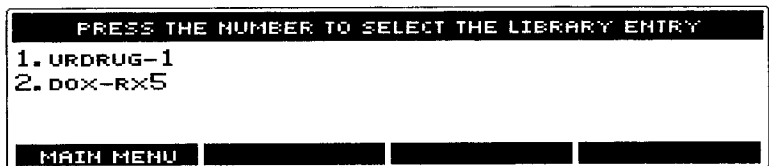

☝ If you then press the **Main Menu** button from the above SELECT THE LIBRARY screen, this toggles the SELECT THE MODE screen or menu. Notice how E-PLATES now appears in the bottom left menu button. If you press the **E-Plates** button, you return to the SELECT THE LIBRARY screen.

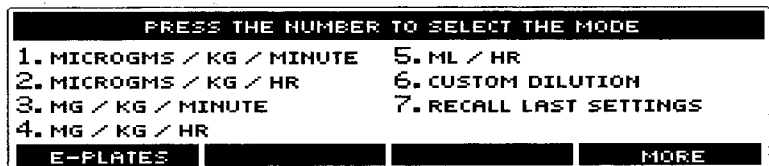

☝ If you press the **E-Plates** button on the above screen, you return to the SELECT THE LIBRARY ENTRY screen.

USING E-PLATES

E-Plates are much easier to use, in fact, than to describe how to use them. If E-Plates are enabled, and there is at least one saved template in the library, you just press a button to select it.

The E-Plate's preset values are loaded automatically into the pump *provided that you have loaded the syringe manufacturer and size programmed for this library entry*. All you have to do then is press the **Start** button to begin the preset infusion after verifying infusion settings.

- To determine enabled or disabled status, see the previous section titled "How to Tell Whether E-Plates Are Enabled For Use".
- To use E-PLATES from the SELECT THE LIBRARY screen.

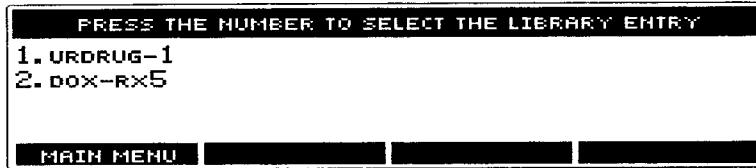

- Use the **number** buttons to select the template you wish to use.

FOR EXAMPLE: If you select "1" above, the pump loads the stored settings for URDRUG-1 infusion and pauses at the BEGIN INFUSION screen.

- All the infusion settings display on the BEGIN INFUSION screen. Always check and verify their correctness. You are responsible for ensuring the safety of any infusion you tell the pump to deliver.

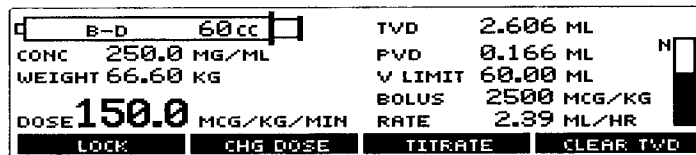

- When ready, press the **Start** button to begin the infusion.

ENABLING E-PLATES & STANDARD LIBRARIES

Depending on the configuration of your pump, E-Plates and libraries *may or may not* be readily available. If you cannot find them as an option in your pump, then they must be **enabled** through custom configuration.

- Refer to the **3010 and 3010a** Syringe Infusion Pump Configuration Manual for setting E-Plate libraries and templates.
- If you have authorization, you may use custom configuration to enable the E-Plates and/or standard libraries. If not, ask the person responsible for custom configuration to make library changes for you.

All such standard dosage templates shall be setup according to the standards & practices of your hospital, unit, or organization.

Displaying E-Plate Options

Even though you may select to enable the E-Plates and standard libraries, the pump display will not offer E-Plates and/or libraries until you actually create and save a template inside a library.

CREATING LIBRARY TEMPLATES

The infusion pump comes with 4 blank libraries built into it. There are 3 Standard Libraries, and 1 E-Plates library. Each library comes with 16 blank entries or templates. These may be filled with presets through custom configuration.

- You are limited to creating 64 templates. This is 16 templates each for the 4 libraries.
- If you have authorization to reconfigure the pump settings, you can delete the contents of library templates, name & rename the templates, and save infusion presets in the templates.

All such standard dosage templates shall be setup according to standards & practices of your hospital, unit, or organization. **3010 and 3010a**

TRANSFERRING LIBRARIES FROM PUMP TO PUMP

Libraries and their stored presets can be copied electronically from one pump to another through the serial communications interface. The process is called “Library Cloning” and involves one pump “Teaching” and the other pump “Learning”.

To learn how to do this, refer to the **3010 and 3010a** Syringe Infusion Pump Configuration Manual.

- If you have authorization, you may use custom configuration to clone libraries. If not, ask the person responsible for custom configuration to make library changes for you.

BATTERY, AC & EXTERNAL DC POWER OPERATION

The infusion pump is normally operated by an AC power supply. This pump may also be operated by an external DC power supply.

Each pump contains a rechargeable battery that is continually charged by the power supply – as long as the pump is connected to AC or external DC power.

If the AC or external DC power is disconnected – while the pump is turned ON – the pump automatically begins drawing power from the internal battery.

ONSCREEN DISPLAY OF INTERNAL BATTERY POWER LEVEL GAUGE

Whenever you turn ON the power, the internal battery charge level briefly appears on the “battery shaped” gauge in the bottom left corner of the display.



When you begin running an infusion on internal battery, this “battery shaped” gauge also appears briefly in the upper right corner of the display at the start of delivery.

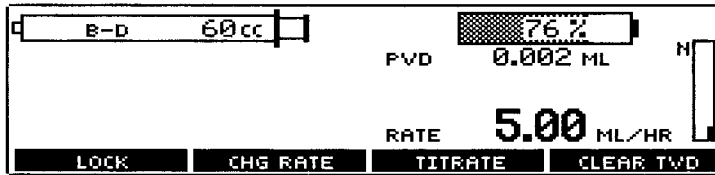

And you can briefly display this “battery shaped” gauge at any time while the pump is infusing on battery by pressing any number button.

BATTERY GUIDELINES

Power & Battery Limits	
When To Charge The Battery	When you see the “Battery Low” message, you should plug the pump into a power outlet for recharging. The battery indicator remains on continuously when charging. If the pump IS plugged into an outlet and fails to charge the battery, withdraw the pump from service for testing by trained biomedical service personnel.
When You Can Run On Battery Alone	The internal battery is intended for allowing you to infuse medications and fluids when an external power outlet is not conveniently available or when the patient is being moved.
When You Cannot Run On Battery	When battery becomes fully depleted, all infusion stops, and a “Battery Depleted” alarm begins sounding. For a fully depleted battery, you must plug in the AC power cord, turn OFF the pump to clear the alarm, and then turn ON the pump.

☞ See “Alarm Priorities & Messages” table to identify battery message status.

EXTERNAL DC POWER OPTION

The infusion pump can also be run by an optional external DC power supply.

The external DC power supply must supply Input 6 – 14 VDC, 7 Watts

This optional DC power supply is connected through a terminal on the rear of the pump.

The connection can be used for either an external battery or other low voltage DC input.

☞ Use only **Medex** approved cabling and power supplies. Refer to Service Manual and pump labeling for this information.

<p align="center">Warning!</p> <p align="center">External Power must be IEC 601-1 Certified</p>	<p>Any external power source connected to the DC jack must be IEC 601-1 certified for medical equipment Type CF and meet Safety Class II requirements. Connecting <u>any</u> external power source to the 3010 and 3010a pumps creates a medical system. Therefore, the user is responsible for compliance with IEC 601-1 standards. Refer all questions to the Medex Technical Service Department.</p>
--	--

CLEANING AND CARE

Below are common methods and cautions relating to cleaning and caring for the infusion pump:

Standard Cleaning of the 3010 and 3010a	<ol style="list-style-type: none"> 1. Follow your institution's guidelines for cleaning and disinfecting of devices. The syringe pump can be safely cleaned with the following agents: <ul style="list-style-type: none"> • <i>Common bleach 10% solution diluted with water.</i> • <i>Mild detergent mixed with water.</i> • <i>Isopropyl alcohol 70% solution.</i> • <i>Surface disinfectants compatible with plastic materials.</i> 2. For best results: Clean by spraying cleanser directly onto a soft cloth and then wiping surfaces dry.
Avoid Using Solvents	NEVER use organic solvents (e.g., acetone), <i>quaternary</i> ammonia compounds, strong acids or bases to clean any portion of the pump.
Spray Resistant	The pump is "spray resistant" from the top and sides but not "water proof". NEVER spray cleaning or other fluids directly into openings on the bottom of the pump.
Not Waterproof	The pump is not certified "water proof". Never immerse the pump in water or other fluids.
Avoid Oil Sprays	NEVER use light oil sprays (e.g., WD40 [™]) to clean or lubricate pump. These oils contain chemicals which can damage the plastic of the pump. No <i>user-added</i> lubrication is necessary.
Never Autoclave	NEVER sterilize the pump in a steam autoclave or gas. Using an autoclave or gas sterilization can seriously damage the infusion pump and void the warranty.

MAINTENANCE & SERVICE

This chapter includes information relating to both standard maintenance and service.

PERIODIC MAINTENANCE

The pump should be tested periodically by trained biomedical service personnel to ensure continued safe operation.

- This testing should be performed at least yearly, or whenever the pump has been damaged or dropped.
- The *occlusion* and *other sensors* must be checked annually to ensure safe operation of the pump.
- Refer to the Service Manual for specific details.

The **3010 and 3010a Configuration Manual**, (PN G6000548) provides information on customizing the settings and features of the pump, which in turn effect the use and operation of the pump on a daily basis.

The **3000 Series Service Manual**, (PN G6000278) provides technical information on this pump, including:

- *Circuit Diagrams*
- *Theory of Operation*
- *Calibration*
- *Functional Descriptions*
- *Diagnosis and Testing*
- *Service Parts*

Service Warnings	
Pump Maintenance	Only trained biomedical service personnel may service this pump. Service personnel should disconnect the AC power cord before servicing the pump.
AC Power	The only means of removing AC power is to disconnect the AC power cord. While the AC power cord is attached to the pump and plugged into an AC outlet, live mains voltage is present within the pump.
Manufacturer Recommended Maintenance	Always maintain this pump following <i>manufacturer recommended instructions</i> in the Service Manual. Improperly maintained pumps may cause either under-infusion or over-infusion to patient.
Never open pump case	Users should never open the pump case or battery compartment for any reason. Service personnel should always disconnect the AC power cord before servicing the pump.
Dropped or Damaged Pumps	Never use a dropped or obviously damaged pump. Withdraw it service until it can be tested by a trained biomedical technician.

USING MEDEX SERVICE ASSISTANCE

Use the following steps to make use of Medex technical service assistance:

1. Contact Medex Technical Service Department at one of the following telephone numbers:

Toll free in continental United States 800-848-1757	Outside continental United States 614-889-2220
Contact via Fax in United States 770-497-0736	In Europe contact Medex Medical Ltd., England +44 (0) 1706-233826

2. When calling any of these numbers, please have the following ready:
 - *Model name / number of pump*
 - *Pump serial number*
 - *Purchase date if pump is within warranty period*
 - *Description of problem in as much detail as possible*
3. The service representative will “talk you through” to a solution if possible.

RETURNING A 3010 OR 3010A PUMP FOR REPAIR

When the service representative cannot solve your problem by talking you through it, then it becomes necessary to return the infusion pump for service.

1. If the problem cannot be resolved through the assistance of the Technical Service Department, then you will be assigned a Return Authorization (RA) number.
2. Clean and decontaminate the pump and accessories prior to returning items to **Medex**. This is required before shipment by United States Occupational Safety & Health Administration (OSHA).
3. Package the infusion pump carefully for shipment.
4. **Medex will not accept returns for service without the assigned RA number clearly printed on the shipping package.** Mark the Return Authorization (RA) number clearly on the outside of the shipping package used to return the pump.
5. Ship the carefully packaged infusion pump to either of the addresses listed below:

United States Service	European Service
<p>Medex 11360 Technology Circle Duluth, Georgia 30097 USA</p> <p>770-623-9809 or 800-848-1757</p>	<p>Medex Medical Ltd. St. Crispin Way Haslingden, Rossendale, Lancashire BB4 4PW Great Britain</p> <p>+44 (0) 1706-233826</p>

MEDEX LIMITED WARRANTY

THIS WARRANTY IS GIVEN IN LIEU OF ANY EXPRESS OR IMPLIED WARRANTIES, INCLUDING WARRANTY OF MERCHANTABILITY, OR FITNESS FOR A PARTICULAR PURPOSE.

Medex warrants to the purchaser that the **3010 and 3010a** Syringe Infusion Pumps shall be free from defects in material and workmanship for the period of one (1) year from the date of purchase. **Medex'** sole obligation with respect to any such defect is limited to the repair, or at **Medex'** option, replacement of the Syringe Infusion Pump. The Purchaser shall pay return freight charges.

This limited warranty is made on the condition that prompt notification of a defect be given to **Medex**, within the warranty period, and that **Medex** shall have the sole right to determine whether a defect exists.

This limited warranty does not apply to Syringe Infusion Pumps that have been partially or completely disassembled, altered, subjected to misuse, negligence, or accident; or operated other than in accordance to the instructions provided within this manual.

While under this limited warranty, **Medex** recommends that the pump **shall not** be opened by personnel other than **Medex** service personnel. Service by unauthorized personnel shall void this limited warranty.

This limited warranty represents the exclusive obligation of **Medex**, and the exclusive remedy of the purchaser regarding defects in a Syringe Infusion Pump.

No person is authorized to modify, in any manner, **Medex'** obligation as described above.

Medex reserves the right to make changes in or additions to pumps manufactured and/or sold by **Medex** at any time, without incurring any obligation to make the same or similar changes on pumps previously manufactured or sold by **Medex**.

Appendix 1: Syringe Flow Rate By Manufacturer & Size

Manufacturer	Size	Min. Rate	Max. Rate
	ml	ml/hr	ml/hr
B. Braun: Luer Lock			
Perfusor	20cc	0.10	481.0
	50cc	0.10	1042
Omnifix	5cc	0.030	207.0
	10cc	0.07	338.0
	20cc	0.10	537.0
	50cc	0.10	1042
Becton-Dickinson: Luer Lock			
WWD	1cc	0.01	35.0
	3cc	0.020	98.00
	5cc	0.030	192.0
	10cc	0.07	278.0
	20cc	0.10	484.0
	30cc	0.10	622.0
	60cc	0.10	944.0
Becton-Dickinson: Glass			
Glass Slip	1cc	0.01	35.0
	2.5cc	0.020	100.0
	5cc	0.030	187.0
	10cc	0.07	271.0

Manufacturer	Size	Min. Rate	Max. Rate
	ml	ml/hr	ml/hr
Sherwood Medical: Luer Lock			
Monoject	1cc	0.01	35.0
	3cc	0.020	105.0
	6cc	0.030	213.0
	12cc	0.07	325.0
	20cc	0.10	536.0
	35cc	0.10	735.0
	60cc	0.10	944.0
Terumo Medical: Luer Lock			
Luer Lock	1cc	0.01	35.0
	3cc	0.020	106.0
	5cc	0.030	225.0
	10cc	0.07	333.0
	20cc	0.10	541.0
	30cc	0.10	712.0
	60cc	0.10	1130
AstraZeneca: Diprivan			
Prefilled Glass	50cc	0.40	952.0

Appendix 2: Flow Delivery Calculations

Rate calculations used by different delivery modes in the syringe infusion pump. Here, the maximum rate is limited by syringe size or the custom configured maximum rate limit. The minimum rate is limited by the syringe size.

MASS MODES

Below is a table of mass modes and the formulae used to calculate them:

Type of Mode	How it is Figured
mcg/min	Rate is calculated as mass delivery rate (microgram/min) times 60 min/hr divided by concentration (mg/ml) divided by 1000.
mcg/hr	Rate is calculated as mass delivery rate (microgram/hr) divided by concentration (mg/ml) divide by 1000.
mg/min	Rate is calculated as mass delivery rate (milligram/min) times 60 min/hr divided by concentration (mg/ml).
mg/hr	Rate is calculated as mass delivery rate (milligram/hr) divided by concentration (mg/ml).
mU/min	Rate is calculated as mass delivery rate (milliUnits/min) times 60 min/hr divided by concentration (U/ml) divided by 1000.
mU/hr	Rate is calculated as mass delivery rate (milliUnits/hr) divided by concentration (U/ml) divided by 1000.
U/min	Rate is calculated as mass delivery rate (Units/min) times 60 min/hr divided by concentration (U/ml).
U/hr	Rate is calculated as mass delivery rate (Units/hr) divided by concentration (U/ml).

BODY WEIGHT MODES

Below is a table of *body weight* modes and the formulae used to calculate them:

Type of Mode	How it is Figured
mg/kg/min	Rate is calculated as patient weight (kg) times dose delivery rate (milligram/kg/min) times 60 min/hr divided by concentration (mg/ml).
mg/kg/hr	Rate is calculated as patient weight (kg) times dose delivery rate (milligram/kg/hr) divided by concentration (mg/ml).
mcg/kg/min	Rate is calculated as patient weight (kg) times dose delivery rate (microgram/kg/min) times 60 min/hr divided by concentration (mg/ml) divided by 1000.
mcg/kg/hr	Rate is calculated as patient weight (kg) times dose delivery rate (microgram/kg/hr) divide by concentration (mg/ml) divided by 1000.

VOLUME / TIME & INTERMITTENT MODES

Below is a table of *volume / time* and *intermittent* modes and the formulae used to calculate them:

Type of Mode	How it is Figured
volume / time	Rate is calculated as volume (ml) divided by time (hours:minutes) where time is rationalized as hours plus minutes divided by 60.
intermittent mode	Rate is calculated as volume (ml) divided by time (hours:minutes) where time is rationalized as hours plus minutes divided by 60; here, there is a time between deliveries with no flow.

CUSTOM DILUTION ALGORITHM

Below is a table of parameters needed to generate the custom dilution formula:

Parameter	Units	Abbreviation
Initial drug concentration	mg/ml	IC
target (volumetric) rate	ml/hr	TVR
patient weight	kg	W
target dose rate	mcg/kg/min*	TDR
final (diluted) volume	ml	FV

* Dose rate is chosen from list of: mg/kg/min, mg/kg/hr, mcg/kg/min, mcg/kg/hr.

THE RESULTS FROM THE DILUTION CALCULATION

Result	Unit	Type
Volume of drug	ml	VDR
Volume of diluent	ml	VDL
Final (delivery) concentration	mg/ml	C
Final (delivery) volumetric rate	ml/hr	R

HOW THE CALCULATION IS PERFORMED

The custom dilution calculation performed is as follows:

1. Find target mass delivery rate = TDR times W times 60 min/hr ; result is in mg/hr units.

[Note: for body weight modes in "/hr", the "times 60 min/hr" is omitted in the equation].

2. Find target concentration = target mass delivery rate / TVR ; result is in mg/ml units.

3. Calculate dilution ratio = target concentration / IC. Result is ratio, unitless.
4. Calculate *Volume of Drug*: $VDR = \text{Dilution ratio} * FV$. Round result to nearest *ml*.
5. Calculate *Volume of Diluent*: $VDL = FV - VDR$. Result is in *ml*.
6. Calculate *Final Concentration*: $C = VDR / FV * IC$. Result is in *mg/ml*.
7. Given that **Target Dose Rate = Final Delivery Dose Rate**.
8. Calculate *Final Volumetric Rate*: $R = \text{Final Dose Rate} * W / C$. Result is in *ml/hr*.

GOAL OF THIS DILUTION CALCULATION

The goal of this calculation is providing a dilution which makes the target dose rate = the final dose rate, while trying to stay as close as possible to the target (volumetric) rate.

In the result of the dilution calculation, the final volumetric rate may be different from the target (volumetric) rate. This is caused by the “round to nearest ml” occurring in step 4 above.

Appendix 3: Serial Communications

This pump contains an optically isolated (Infrared) serial communications interface. With an optional Medex conversion box, this pump can be connected to a standard computer RS-232 serial interface.

This process is called *Configuration Cloning*, and it allows pump setting information to be copied from one pump to another (see *Configuration Manual*). The interface provides capability for a remote computer to collect:

- *Pump Settings*
- *Pump Libraries*
- *Current Delivery Information*

SERIAL CONVERSION BOX

Another option is the Medex Serial Conversion Box, which allows direct connection between the Series 3000 pumps and a PC running the PC Cloning software. This software provides a full-featured simulation of the functioning of the Series 3000 pumps. This can be used as both a training tool and a configuration utility.

As a configuration utility, the simulated pump can be setup exactly as a unit or department needs to use it. Then these configuration settings may be transferred *en masse* from the PC to actual pumps.

Specific details on the serial interface protocol are provided with the conversion box, (P/N 3000RS232).

MEDEX CLONING BLOCK

Two pumps can be interfaced without the use of the conversion box. Depending on your working surface, it may be difficult to perfectly align the infrared serial ports by hand.

Instead use an optional, *Medex Cloning Block*, (P/N **G6000200**) to physically align the two pumps. This is a specially designed plastic plug which fits into the serial port notches on the backs of both pumps – providing simple alignment for both pumps every time.

Appendix 4: Pole Clamp Assembly & Use

This appendix contains the instructions for assembling and using the Pole Clamp options available for the **3000 Series** infusion pumps.

The 3000 Series stationary pole clamp is packed in a bag in pieces, which must be assembled before it, can be used:

- The Pole Clamp assembly – with 4 “*pan head*” screws & 4 lock washers already inserted.
- The “L” Bracket – which must be attached for mounting on either a *vertical* or *horizontal pole*.
- 2 “*flathead*” screws and 2 “*conical*” lock washers – in a small plastic bag.

The 3000 Series rotating/detachable pole clamp is packaged in two pieces that must be clipped together before it can be used:

- The “L” Bracket and clamp anchor with release lever - is pre-attached to the pump base with 2 “flathead” screws
- The Rotating pole clamp - which must be slid onto the clamp anchor at the back of the pump

USING THE 3000 SERIES PUMP STATIONARY POLE CLAMP

With the “L” bracket, you can align the pole clamp for mounting on any *vertical* or *horizontal* pole, bed rail, or similar solid structure small enough to fit within the clamp’s jaws. The light weight of the pump makes this convenient.

1. Open the clamp jaws wide enough to easily slip around the pole.
2. Tighten the clamp until it is securely fastened so the pump cannot be moved.

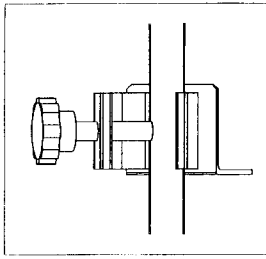

Clamp with "L" bracket aligned for *vertical* pole mounting.

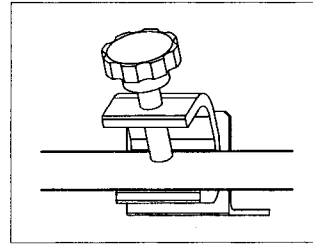

Clamp with "L" bracket aligned for *horizontal* pole mounting.

ASSEMBLING THE 3000 SERIES PUMP STATIONARY POLE CLAMP

You need a "Philips" head screwdriver. The steps for assembling the pole clamp are given below:

1. Unpack the pole clamp assembly from the shipping container.
2. The "L" bracket attaches the pole clamp to the pump. When you receive the pole clamp assembly, it is configured for use with a vertical pole. If you wish to change this assembly for use with a horizontal pole (e.g. bed rail), then you must reconfigure the "L" bracket using the following steps:
 - Remove the 4 "pan head" screws and their lock washers from the rear of the pole clamp.
 - Align the "L" bracket for *horizontal* mounting (see previous page). Install the 4 washers and pan head screws to mount the "L" bracket to the clamp. Tighten them to at least 10 in-lb (1.1 Nm) torque.
3. Use the small "flathead" screws and "star" lock washers to attach the pole clamp to the bottom of the pump. Tighten them to at least 10 in-lb (1.1 Nm) torque.

ASSEMBLING THE 3000 SERIES PUMP ROTATING/DETACHABLE POLE CLAMP

1. Unpack the pump and pole clamp assembly from the shipping container
2. Slide the rotating pole clamp onto the pole clamp anchor at the rear of the pump until the retainer lock button audibly clicks into place
3. Pull the round lock button at the top of the clamp assembly up and rotate the clamp to fit either a vertical or horizontal pole

4. To remove the pump from the pole clamp, pull the release lever toward the pump and slide the pump off the pole clamp
Using the 3000 Series Pump Rotating/Detachable Pole Clamp Pole Clamp

With the Rotating Clamp, you can align the pole clamp for mounting on any *vertical* or *horizontal* pole, bed rail, or similar solid structure small enough to fit within the clamp's jaws. The light weight of the pump makes this convenient.

1. Open the clamp jaws wide enough to easily slip around the pole.
2. Tighten the clamp until it is securely fastened so the pump cannot be moved.

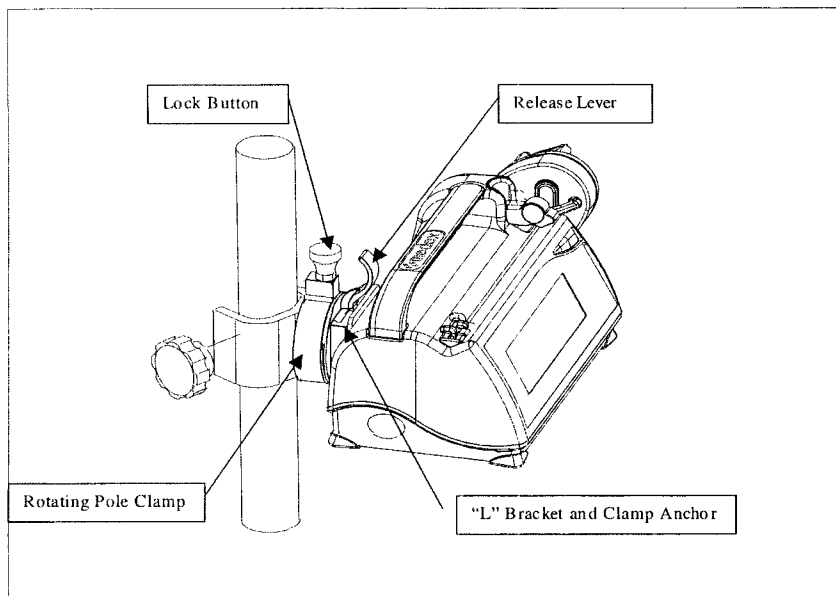

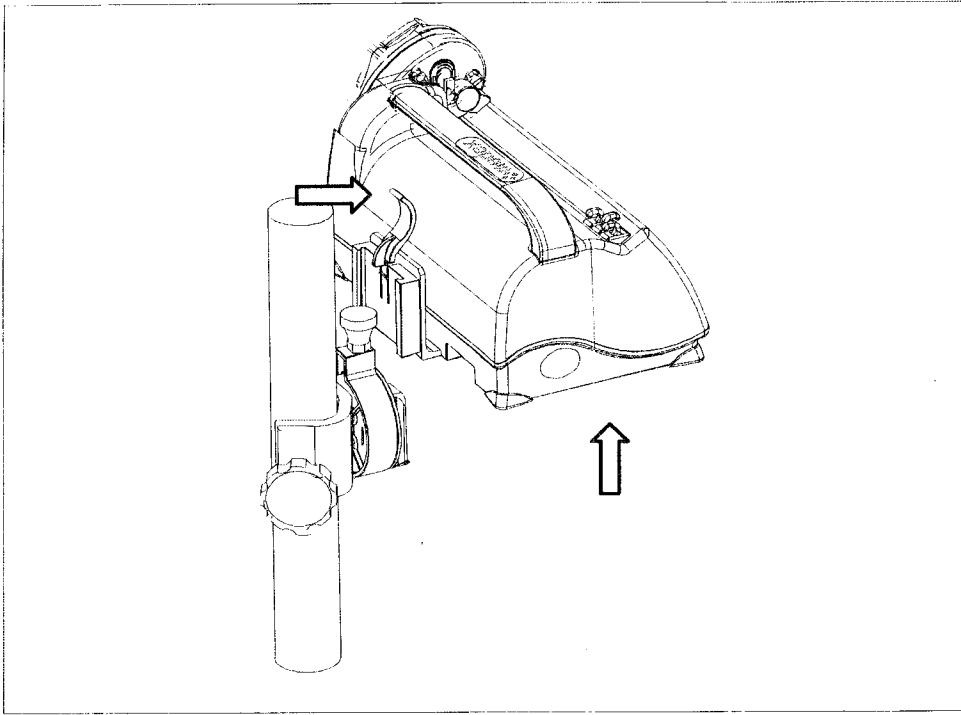

APPENDIX 5: MRI ROOM USAGE

MRI ROOM USAGE FOR THE 3010 AND 3010A

The magnetic resonance imaging (MRI) room usage information for MRI procedures (i.e., imaging, angiography, functional imaging, and spectroscopy) refers to the use of a shielded MRI system operating at a static magnetic field of 1.5 Tesla with radio frequency transmission and reception at 64 MHz. The effects of using other MRI systems have not been determined for this infusion pump.

The 3010 and 3010a syringe infusion pumps have been determined to be acceptable for use in MRI rooms based upon the specific operating criteria indicated below. The pump, when correctly placed and operated within this 1.5 T/64 MHz MR environment, will not present an additional hazard or risk to the patient or MR user, and the pump will not affect the image quality of the MRI examination.

MRI procedures using the pumps must only be performed according to the specific operating guidelines as follows:

◆ PROPER PLACEMENT OF PUMP

The pump must be positioned in the MR environment of a 1.5 Tesla MRI system in a magnetic fringe field that does not exceed 150 gauss.

WARNING! Placement of the pump in a magnetic fringe field greater than 150 gauss may present a projectile hazard to the patient or MRI user because of magnetic field interactions. In addition, the operation of the pump may be affected and/or degrade or alter the quality of the MR images that are obtained.

WARNING! The pump must be securely fastened to a non-moveable object while positioned in the MR environment.

◆ PULSE SEQUENCES FOR MRI WHEN USING THE 3010 AND 3010A

With the pump operating in a proper position relative to the 1.5 Tesla MRI system (i.e. a magnetic fringe field of 150 gauss or less), the use of standard spin echo, fast spin echo, and gradient echo pulse sequences for MRI examinations has been determined to produce no substantial alteration in image quality. The use of unconventional or non-standard MRI techniques has not been assessed and must be avoided.

Note: Since the interface between the pump and the patient does not involve any thermally conductive material, there is no concern with respect to possible heating of this device during an MRI procedure.