

Operator's Manual

Colleague

VOLUMETRIC INFUSION PUMP

PRODUCT CODE: 2M8151, 2M8151K

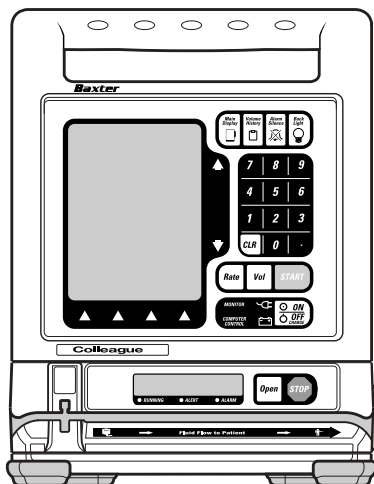

Baxter

Prior to using this pump, read this manual carefully to fully understand the pump's functionality and to ensure safe and proper operation.

Warning

There are risks associated with using anything other than the recommended sets with this device. Sets designated for use with this device are identified in Chapter 3, Administration Sets. Baxter's warranty on this device will be null and void and Baxter will assume no responsibility for incidents which may occur if the product is not used in accordance with product labelling. See Chapter 1 for a complete list of warnings and cautions.

Computer Software Copyrights

©Copyright 1996 – 2000, Baxter Healthcare Corporation. All rights reserved.

For use only by Baxter Healthcare Corporation. The software contains proprietary information belonging to Baxter Healthcare Corporation. The software must not be reproduced or disclosed to others without prior written approval. Any unauthorized use of this information may subject the user to substantial liability.

Documentation Copyrights

Duplication or distribution of this manual and any information contained within is strictly prohibited without the express written permission of Baxter. This manual and any information contained within, may not be reproduced, distributed, or transmitted in any form, or by any means, for any purpose, without the express written permission of Baxter. To order additional copies of this manual, or other related manuals, contact your local Baxter Service Center.

Disclaimer

The information in this document has been carefully examined and is believed to be entirely reliable. However, no responsibility is assumed for inaccuracies. Furthermore, Baxter reserves the right to make changes to any products herein to improve readability, function, or design. Baxter does not assume any liability arising out of the application or use of any product or circuit described herein; neither does it cover any license under its patent rights nor the rights of others.

Trademark Information

Baxter, the Baxter wordmark, **Colleague**, **Personality**, **Personalities**, **Pump Personality**, **Pump Personalities**, **Interlink**, **Buretrol**, **Continu-Flo**, and the shape of the On/Off Clamp are trademarks of Baxter International Inc. in the U.S. Other trademark applications pending. TOR and Hi-Tor Plus are trademarks of Huntington Professional Products. LpH is a trademark of Steris Corporation. Cidex 7 is a trademark of Johnson & Johnson. Super Edisonite is a trademark of Brand GmbH. Bafix is a trademark of Hysan Corporation. Other product names appearing in this manual are the property of their respective owners.

Year 2000 Compliance

This product is Year 2000 Compliant and will function as designed through 2035 without interruption or failure by the occurrence of dates prior to, during or after year 2000.

Patent Information

This device is protected under one or more of the following U.S. and Foreign Patents: **United States:** 5,151,019; 5,764,034; 5,782,805; 5,799,207; 5,842,841; 5,843,035; 6,013,057; 6,068,612; 6,129,517; D390,654. **Foreign:** Australia: 130,693; 706,742; 710,286; 712,859; 713,132; 721,076; 723,365; 727,479; 730,132; 736,366; 740,655; Benelux: 27657; Canada: Des. 80218 (BII); Denmark: 165/97; Germany: M9608875.3; GB: 2,059,861; 2,224,239; 2,312,049; 2,312,055; 2,319,079; 2,338,753; 2,338,756; 2,338,757; 2,338,758; 2,338,992; 2,342,188; Japan: 1002447; Korea: 207012; New Zealand: 329316; 329317; 329318; 329320; 333087; 333088; 333089; 333090; 333091; 333092; 333093; Des. 28022; R.O.C.: 098653; 096216; 090525; 092501; 101,347; 102,585; Des. 058282; Singapore: 47257; 54666; 75193; 83175; Sweden: 61479; South Africa: 2000/5266; other U.S. and Foreign patents pending.

Table of Contents

Material Specifications	vi
Meaning of the CE Mark Symbol	vii
Chapter 1 Introduction	1-1
Overview	1-1
Safety Summary	1-5
General	1-5
Warnings	1-7
Cautions	1-8
Notes	1-10
Chapter 2 Pump Description	2-1
Overview	2-1
Main Body	2-2
Main Display	2-5
Pump Module	2-6
Rear Panel	2-8
Display Reference Guide	2-9
Main Display Screen	2-9
Programming Screens	2-10
Main Display Icons	2-11
Label Location	2-12

Chapter 3 Basic Operation	3-1
Setting Up the Pump	3-1
Initial Installation	3-1
Mounting Clamp Overview	3-1
Mounting the Pump on an IV Pole	3-2
Mounting the Pump on a Headboard	3-2
Changing the Mounting Bracket Orientation.....	3-3
Recommended Administration Sets.....	3-4
In EEC Countries	3-4
In Latin America.....	3-4
In the United States.....	3-4
Preparing the Primary Infusion Container and Set	3-5
Powering On the Pump	3-6
Powering Off the Pump	3-8
Loading the Administration Set	3-9
Unloading the Administration Set	3-10
Using the Manual Tube Release	3-11
Resetting the Manual Tube Release.....	3-12
Programming a Primary Rate-Volume Infusion.....	3-13
Completing or Stopping a Primary Infusion.....	3-15
Completing an Infusion	3-15
Stopping an Infusion Before Completion	3-15
Programming a Piggyback Infusion	3-16
Piggyback Infusion Overview	3-16
Piggyback Callback Alert Option	3-16
Preparing a Piggyback Infusion Set.....	3-17
Programming a Piggyback Infusion	3-17
Stopping a Piggyback Infusion Before Completion	3-18
Changing the Flow Rate During an Infusion	3-19
Volume History.....	3-20
Volume History Overview	3-20
Using and Clearing Volume History	3-20
Panel Lockout	3-21
Panel Lockout Overview	3-21
Using Panel Lockout.....	3-21

Chapter 4 Using the Options Menu	4-1
Overview	4-1
Using Flow Check Display	4-2
Viewing Current Pump Personality Feature Set	4-3
Overriding the Downstream Occlusion Values.....	4-4
Auto Restart	4-5
Checking Battery Charge Level	4-5
Using the Configuration/Service Function	4-6
Chapter 5 Advanced Features	5-1
Overview	5-1
Label Library.....	5-2
Overview	5-2
Selecting a Label.....	5-3
Optional Dose Programming Functions.....	5-4
Overview	5-4
Programming a Dose Independent of Patient Parameters.....	5-5
Programming a Dose Based on Patient Weight	5-11
Discontinuing a Dose Program	5-14
Using the Optional Volume-Time Programming Function	5-15
Overview	5-15
Using Volume-Time Programming	5-15
Using the Optional Prime Function	5-17
Overview	5-17
Priming the Administration Set.....	5-17

Standby Mode	5-19
Standby Overview	5-19
Program Parameter Retention	5-19
Enabling Standby	5-20
Preprogramming the Pump for Future Use	5-21
Exiting Standby Mode	5-21
Using the Optional Accessories	5-22
Nurse Call	5-22
Syringe Adapter	5-22
Configuration Transfer Cable	5-22
Event History Download Kit	5-23
Personality Feature Sets	5-23
Overview	5-23
Selecting a Pump Personality Feature Set	5-24
Chapter 6 Troubleshooting	6-1
Alert, Alarm, and Failure Messages	6-1
Troubleshooting Alerts	6-1
Overview	6-1
Troubleshooting Advance Air Alerts	6-2
Troubleshooting Other Alerts	6-4
Troubleshooting Alarms	6-5
Overview	6-5
Troubleshooting Air Detected Alarms	6-5
Troubleshooting Other Alarms	6-8
Troubleshooting Failures	6-10
Overview	6-10
Acknowledging Channel Failures	6-10
Unloading the Administration Set after Channel Failure	6-12
Resetting Manual Tube Release after Channel Failure	6-12

Chapter 7 Maintenance and Storage	7-1
Cleaning Overview	7-1
Recommended Cleaners.....	7-1
Preventive Maintenance	7-2
Battery Operation Overview	7-3
Battery Charging.....	7-3
Battery Disposal.....	7-3
Storage	7-4
Chapter 8 Technical Specifications	8-1
Recommended Practices	8-3
Volumetric Accuracy of the System	8-4
Startup Graph Description	8-4
How Trumpet Curve Graphs are Interpreted	8-5
How Trumpet Curve Graphs are Created.....	8-5
How Trumpet Curves can be Used	8-6
Accuracy Test per Sub-Clause 50.4 of IEC 60601-2-24 Part 2 at 1 mL/hr	8-6
Accuracy Test per Sub-Clause 50.4 of IEC 60601-2-24 Part 2 at 25 mL/hr	8-7
Chapter 9 Configurable Options	9-1
Overview	9-1
Configurable Options List.....	9-1
Pump Configurable Items	9-1
Personality Feature Set Configurable Settings.....	9-2
Label Library.....	9-5
Predefined Label List	9-5
Application Labels	9-8
Custom Labels.....	9-8
Chapter 10 Warranty and Service Information	10-1
Warranty.....	10-1
Service Information.....	10-2
Authorized Service Centers	10-2
Index	Index-1

Material Specifications

The pump contains the plastics and alloys listed below.

Note: No natural latex was used in the manufacture of this pump.

- Acrylonitrile Butadiene Styrene (ABS)
- Acetal
- Acetal 25% Glass Fiber (GF) Reinforced
- Acetal + Polytetrafluoroethylene (PTFE)
- Acrylic
- Aluminum A380.0
- 13% GF Nylon
- 30% GF Nylon
- 33% GF Nylon
- 30% GF Reinforced Polybutylene Terephthalate (PBT)
- 30% GF PBT + PTFE
- 40% GF Polyphenylene Sulfide (PPS)
- PBT
- Polycarbonate (PC)/ABS¹
- Polyetheretherketone (PEEK)
- Polyester PBT
- Polypropylene
- Thermoplastic Synthetic Rubber

1. Pump housing components may be made of PC/ABS or Acetal.
Some pumps may contain PC/ABS and Acetal components.



Meaning of the CE Mark Symbol

This symbol represents adherence to Council Directive 93/42/EEC (14 June 1993) of the European Communities concerning medical devices.

The electromagnetic compatibility (EMC) requirements are part of the essential requirements of the Medical Device Directive.

Device:	Colleague Volumetric Infusion Pump
Catalogue Number:	2M8151K
Manufacturer:	Manufactured by an affiliate of: Baxter Healthcare Corporation Deerfield, IL 60015 USA Made in Singapore
Authorised Representative:	Baxter S.A. B-7860 Lessines, Belgium

Introduction

Overview

The Colleague Volumetric Infusion Pump is designed to meet the fluid delivery needs of today's evolving healthcare environment. The Colleague Pump can be utilized for continuous or intermittent delivery through clinically acceptable routes of administration such as, intravenous (IV), intra-arterial (IA), subcutaneous, epidural, or irrigation of fluid spaces applications.

Fluid delivery applications include:

- parenteral fluids, drugs and electrolytes
- total parenteral nutrition solutions
- solutions for irrigation procedures
- whole blood and blood products.

The Colleague Volumetric Infusion Pump is designed to follow the patient through the continuum of care and is suitable for use in a variety of care areas, including but not limited to:

- | | |
|--------------------------------|-------------------------|
| ■ Hospitals | ■ Mobile Intensive Care |
| •General Floor | ■ Homecare |
| •Medical/Surgical | ■ Blood Centers |
| •Critical/Intensive Care Areas | ■ Nuclear Medicine |
| •Pediatrics/Neonatal | ■ Hospice |
| •Labour/Delivery/Post Partum | ■ Subacute Facilities |
| •OR/Anesthesia | ■ Long Term Care |
| •Post Anesthesia/Recovery | ■ Nursing Homes |
| •Cardiac Catheter Lab | |
| •Emergency Room | |
| •Burn Unit/Trauma | |
| •Oncology | |

The Colleague Pump feature spectrum includes:

- Micro and Macro Rate Range
- Basic Delivery Programming
- Piggybacking Secondary Medications
- Special Programming Functions for Dosing

The following pump features help provide safe, efficacious, and reliable therapy:

- Automatic tube loading with misloading detection
- A keyed On/Off Clamp to minimize potential errors attributed to installing or removing the administration set
- A panel lockout function which minimizes the potential for tampering or inadvertent removal of the administration set
- Programmable air sensor with detection sensitivity ranging from 25 to 150 micro liters
- Automatic restart functions if occlusions are corrected within 60 seconds after detection
- Programmable occlusion detection settings ranging from 2 psig to 15 psig (103 mmHg to 775 mmHg)
- A flow check graphic displaying in-line resistance to flow
- A label library displaying the fluid or line being administered. Custom labels can be programmed if desired.
- A battery charge level display to indicate level of battery charge for transport applications

The pump has a flexible, graphical interface that can be used to configure the available features. As many as eight custom Personality feature sets can be created by selecting the operating functions which are needed to meet the needs of an individual care area or for specific therapies. This flexible platform allows the pump to be used for simple infusions or medication therapies requiring complex dose calculations for each care setting. See “Technical Specifications,” 8-1 for configurable features and default settings.

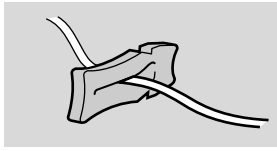

U.S.: Uses Baxter standard administration sets equipped with keyed On/Off Clamps.

EEC COUNTRIES: Uses Baxter Green Label C96XX administration sets equipped with keyed On/Off Clamps.

See “Recommended Administration Sets,” 3-4.

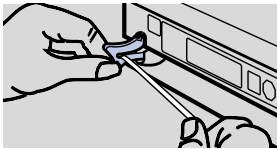

Automatic Tube Loading

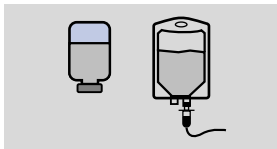

Variety of Source Containers

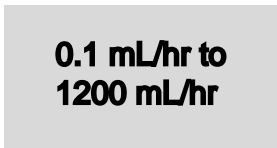

Micro and Macro Rate Range

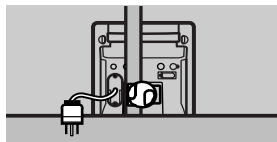

Mounting Clamp and Headboard Mounting Provisions

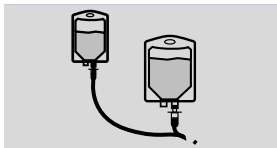

Piggybacking Secondary Medications with Configurable Callback Option



Dose Programming Modes



Configurable Air Sensor Settings

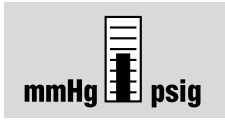

User Selectable Downstream Occlusion Pressure Settings (mmHg and psig)

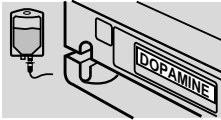

Label Library



Flow Check Display Indicating Downstream In-line Resistance to Flow



Panel Lockout with Optional Auto Lock Function to Minimize Potential for Tampering and Set Removal



Configurable Pump Personality Feature Sets

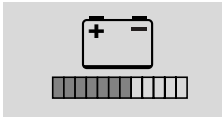

Battery Charge Level Indicator



Nurse Call

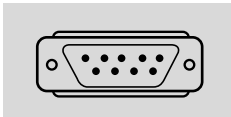

Communications Port

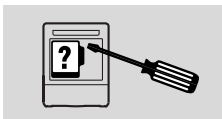

Diagnostics Functions

Safety Summary

General

1

- **BEFORE INITIALLY POWERING ON THE PUMP, CHARGE THE BATTERY FOR AT LEAST 12 HOURS. A COMPLETE CHARGE MAY TAKE LONGER THAN 12 HOURS.**

- Prior to operating this pump, the user should carefully read this manual to fully understand the functionality and to ensure safe and proper operation.

- Although the Colleague Pump has been designed and manufactured to exacting specifications, it is not intended to replace trained personnel in the supervision of IV infusions.

Note: U.S. only: lay users should always have access to a trained professional when using this pump. In addition, lay users should read and follow the appropriate instructions in the Colleague Volumetric Infusion Pump Home Care User Guide available through their clinician.

Note: Outside the U.S.: read document VDE0753-5 when performing parallel infusions.

- In accordance with UL 2601-1, Second edition, and CAN/CSA C22.2 No. 601.1, this pump is classified as:
 - Class 1
 - Type CF
 - Drip-proof (IPX1)
 - Not suitable for use with flammable anesthetic mixtures with air, oxygen or nitrous oxide
 - Continuous operation
- This manual has been developed with consideration to the requirements in the International Standard, IEC 60601-2-24 (1998-02) Medical Electrical Equipment — Part 2-24: Particular Requirements for Safety of Infusion Pumps and Controllers. Data presented in the Technical Specifications reflect specific test conditions defined in this standard. Other external factors such as varying back pressure, temperature, head height, set usage, fluid restrictions, solution viscosity, or combinations of these factors, may result in deviations from the performance data enclosed.
- When disposing of this device or the administration sets designed for use with the device, adhere to local regulations and guidelines.

■ Definitions:

Warning messages indicate a possible hazard which, if not avoided, could result in severe personal injury or death.

Caution messages indicate a problem or unsafe practice which, if not avoided, could result in minor or moderate personal injury, product or property damage.

Note messages provide supplemental information to the accompanying text.

■ Labeling symbol definitions:

IPX1 Drip-proof equipment: enclosed equipment protected against dripping fluids.

~ Alternating current or equipment intended to be connected to an alternating current (AC) source.



Fuse.



Attention, consult accompanying documents.



Type CF equipment in accordance with UL2601-1.



Recyclable, dispose of properly.



This product is classified by Underwriters Laboratories Inc. with respect to electric shock, fire, and mechanical hazards only in accordance with UL 2601-1, Second edition, and CAN/CSA C22.2 No. 601.1.

■ Labeling abbreviations:

COMM. PORT Communications Port

VOL. Volume

CONT. Contrast

■ Serial Number Format:

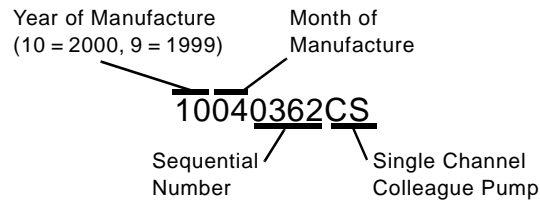

Examples:

8060517CS manufactured June 1998
 9081234CS manufactured August 1999
 10025678CS manufactured February 2000

1

Warnings

! WARNING !

To ensure safe and proper operation, read the manual and any instructions accompanying disposables or accessories before operating this device.

! WARNING !

EEC COUNTRIES: Use only Baxter “Green Label” C96XX administration sets equipped with keyed On/Off Clamps. There are risks associated with using anything other than the recommended administration sets with this device.

! WARNING !

LATIN AMERICA: Use only the following administration sets: Baxter “Green Label” C96XX administration sets equipped with keyed On/Off Clamps, or Baxter standard administration sets equipped with keyed On/Off Clamps that have an “s” after the code number, or are labeled as pump compatible. If you have questions about administration set compatibility, contact the Baxter Product Information Center at the number shown on the administration set labeling. There are risks associated with using anything other than the recommended administration sets with this device.

! WARNING !

U.S.: Use only Baxter standard administration sets equipped with keyed On/Off Clamps that have an “s” after the code number, or are labeled as pump compatible. If you have questions about administration set compatibility, contact the Baxter Product Information Center at the number shown on the administration set labeling. There are risks associated with using anything other than the recommended administration sets with this device.

! WARNING !

EEC COUNTRIES: Use only Continu-Flo “Green Label” C96XX administration sets as the primary fluid line when administering a secondary medication. **ELSEWHERE:** Use only Continu-Flo standard administration sets equipped with keyed On/Off Clamps as the primary fluid line when administering a secondary medication. See “Recommended Administration Sets,” 3-4. Carefully follow the directions on the primary and secondary administration set labels.

! WARNING !

The administration sets should be disposed of in an appropriate manner, considering the nature of the residual fluid that may be contained within, in accordance with the hospital disposal practices.

! WARNING !

This pump should be used only with Baxter accessories specified in “Using the Optional Accessories,” 5-22. There are risks associated with using anything other than the recommended accessories with this pump.

! WARNING !

Always read and follow the instructions which accompany the source container and administration sets you are using. Carefully follow the instructions for loading, removing, and reloading the set, as well as the recommended set change interval. Set use should not exceed the label set change interval or 72 hours, whichever is less.

- ! WARNING !** While the Colleague Pump automatically closes the keyed On/Off Clamp, always close the regulating clamp on the administration set before removing the administration set from the pump.
- ! WARNING !** DO NOT CONNECT THE ADMINISTRATION SET TO THE PATIENT WHEN PRIMING.
- ! WARNING !** Prior to starting an infusion, verify that no drops are falling in the drip chamber and the programmed information is correct.
- ! WARNING !** If the pump has been dropped or appears to be damaged, it should be taken out of service and inspected by qualified service personnel only.
- ! WARNING !** Epidural administration of drugs other than those indicated for epidural use could result in serious injury to the patient.
- Epidural administration of anesthetics is limited to short term infusion (not to exceed 96 hours) with indwelling catheters specifically indicated for short term anesthetic epidural drug delivery.
 - Epidural administration of analgesics is limited to use with indwelling catheters specifically indicated for either short term or long term analgesic epidural drug delivery.
 - To prevent infusion of drugs not indicated for epidural use, do not use administration sets incorporating injection sites during epidural delivery.
 - Clearly distinguish pumps used for epidural drug delivery from pumps used for other routes of administration.

Cautions

- Caution** In the U.S., use of device is restricted by Federal Law (USA) to sale or use by, on the order of, or under the supervision of a physician or other licensed healthcare professional.
- Caution** Use only accessory equipment complying with the device's safety requirements; failure to do so may lead to reduced safety levels of the resulting system. Consideration relating to accessory choice shall also include:
- use of the accessory in the patient vicinity
 - evidence the safety certification of the accessory has been performed in accordance with the appropriate UL2601-1 or IEC 60601-1 and/or IEC 601-1-1 harmonized national standard.
- Caution** The power cord must be connected to a 100-120 VAC 50/60 Hz or 220-240 VAC 50/60 Hz, properly grounded 3-wire receptacle.
- Caution** As with all medical electronic equipment, care must be exercised to avoid exposing this device to powerful sources of electromagnetic interference. This device design has been tested to current U.S. and European standards and guidelines for medical devices. The device was not found to be affected adversely by these susceptibility tests and will perform safely. The device's emissions also were found to be acceptable. Using the pump near operating equipment which radiate high energy radio frequencies (such as electrosurgical/cauterising equipment, two-way radios, or cellular telephones) may cause false alarm conditions. If this happens, reposition the pump away from the source of interference; or turn off the pump and, if clinically necessary, manually regulate the flow with the regulating clamp according to your institution's guidelines.

Caution

When infusing through a central line catheter, Baxter recommends using sets with a Luer lock adapter.

Caution

Follow the cleaning schedule and methods defined under “Cleaning Overview,” 7-1 to ensure proper maintenance of the device.

Caution

Do not clean, disinfect, or sterilize any part of the pump by autoclaving or with ethylene oxide gas. Doing so may damage the pump and void the warranty. Only external parts of the pump should be disinfected.

Caution

Do not use the following chemicals on the pump, as they will damage the front panel: acetone, acetoaldehyde, ammonia, benzene, hydroxytoluene, methylene chloride, and ozone. Do not use cleaners containing n-alkyl dimethyl ethylbenzyl ammonium chloride unless they are listed in Chapter 7.

Caution

When attaching this pump to an IV pole or other mounting locations, ensure it has been securely clamped.

Caution

Ensure pump is mounted where main body is easily accessible and administration set can be loaded without being stretched or kinked.

Caution

Ensure that the headboard or footboard is stable, secure, and has a depth greater than 1.91 cm (3/4 inches) and height of at least 5 cm (2 inches).

Caution

To avoid personal injury, ensure that the IV pole is stable and secure. Ensure that the pole is able to support the pump, along with any other devices, without tipping or falling. The pole diameter should be between 0.95 and 3.81 cm (3/8 inch and 1-1/2 inches).

Caution

The pump should never be placed on the bed alongside the patient.

Caution

This pump may interact with some ECG equipment during infusions. Proper set-up of ECG should eliminate any difficulties. Consult the ECG instruction manual for more information.

Caution

Grounding reliability can only be achieved when the pump is connected to an earth-grounded receptacle. (When grounding reliability is in doubt, the pump shall be powered by its battery).

Caution

If flow is observed when tubing is loaded but the pump is not running, close the regulating clamp immediately. Ensure that all steps have been properly performed. If flow is still observed, remove the pump from service and contact a Baxter authorized service person.

Notes

Note: No natural latex was used in the manufacture of this pump.

Note: The pump's user interface language is selected at the time of manufacture and corresponds to the language used on the external labeling and keypad. Certain combinations of error codes can result in default to the English language. If this should occur, discontinue using the pump and contact your authorized Baxter Service Center for assistance.

Note: U.S. Law requires tracking of this device. Parties acquiring this device must:

- Promptly report the receipt of this device to the manufacturer;
- Report the device's purchases, receipt in trade, return after sale, loss, destruction, or retirement.
- If this is an initial purchase from the manufacturer, you may return a signed copy of the packing list to the manufacturer in order to comply with these requirements. Call 1-800-THE-PUMP for additional information.

Pump Description

Overview

This chapter describes the operator controls and indicators on the pump.

Main Body

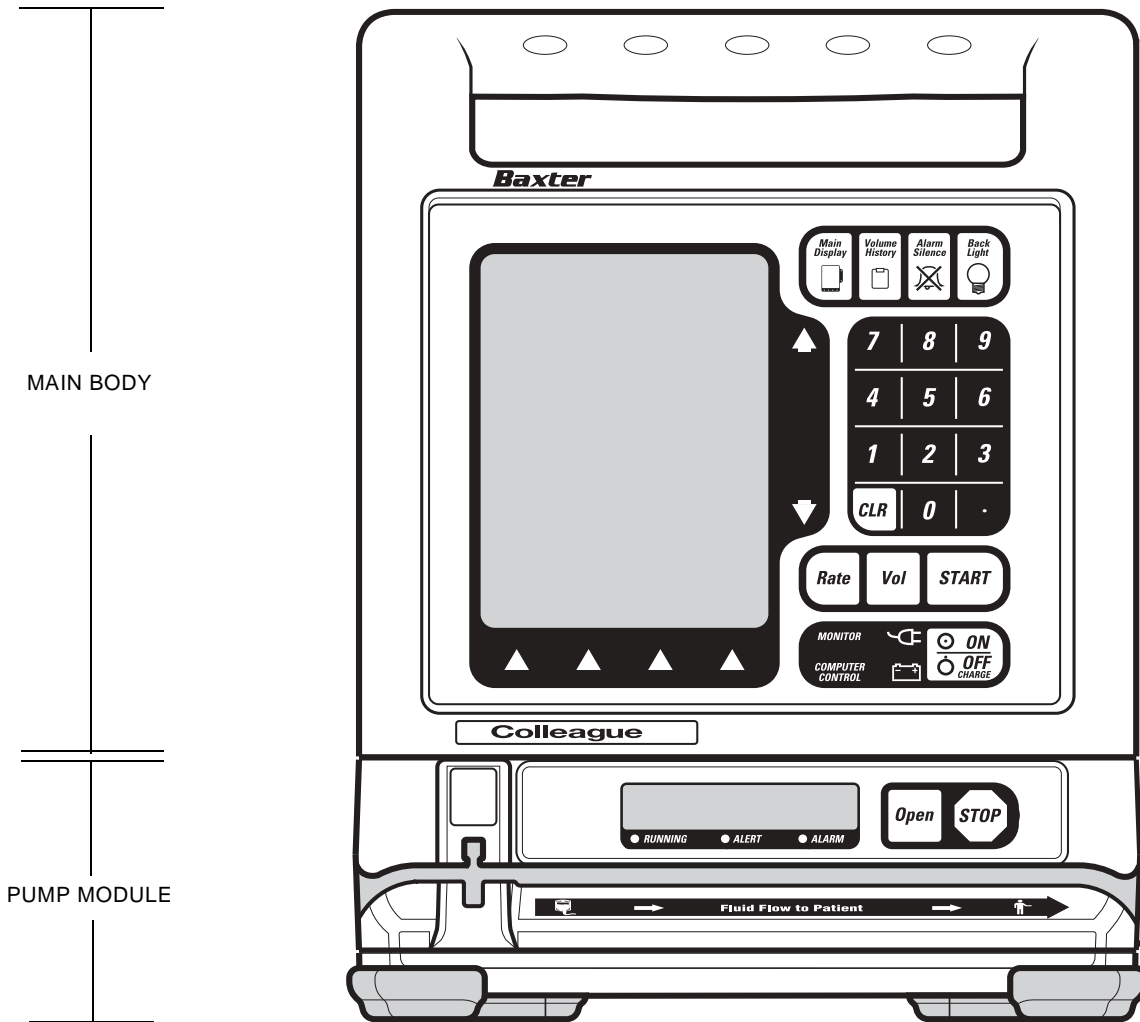
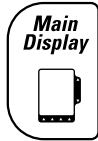







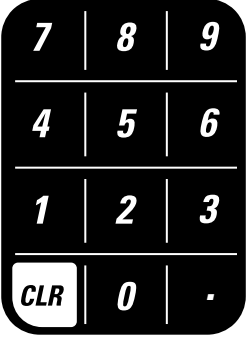





Figure 2-1 Front View

Item	Description
Function Keys	
	<p>This key accesses the Main Display screen from all other operating screens, except screens with pop-up windows or passcode service functions.</p>
	<p>This key accesses the Volume History screen.</p>
	<p>This key silences alarms and alerts for two minutes.</p>
	<p>This key turns the back lights for the displays on and off. During battery-powered operation, this key illuminates the back lights for one minute following the last key press.</p>
Action Keys	
	<p>This key selects the Rate field.</p>
	<p>This key selects the Vol (Volume to be Infused) field.</p>
	<p>This key initiates infusion from any programming screen if all the required programming values have been entered. After the resolution of an alarm, pressing the START key cancels the alarm notification and starts the infusion.</p>
	<p>This key powers on the pump. If the pump is on, pressing this key powers down all parts of the pump except memory and circuits that monitor information such as battery charge level.</p>

Item	Description
Numeric Keypad	
	<p>The numeric keys and decimal point key are used to enter programming values.</p>
	<p>This key clears the values from the field highlighted on the display. Pressing the key a second time restores the last value saved. If multiple fields were cleared, the pump attempts to restore values whenever possible.</p> <p>This key can also be used to clear a label if the label field is highlighted and the infusion is stopped.</p>
Icons	
	<p>This green icon is lit whenever the pump is plugged into AC power. Illumination of this icon also indicates the battery is being charged.</p>
	<p>This yellow icon is lit only when the pump is operating on battery power.</p>
<p>MONITOR</p>	<p>The pump can be monitored by a computer connected to the COMM port on the rear.</p>
<p>COMPUTER CONTROL</p>	<p>FOR FUTURE USE.</p>

Main Display

The display has six main areas for information and manipulation:

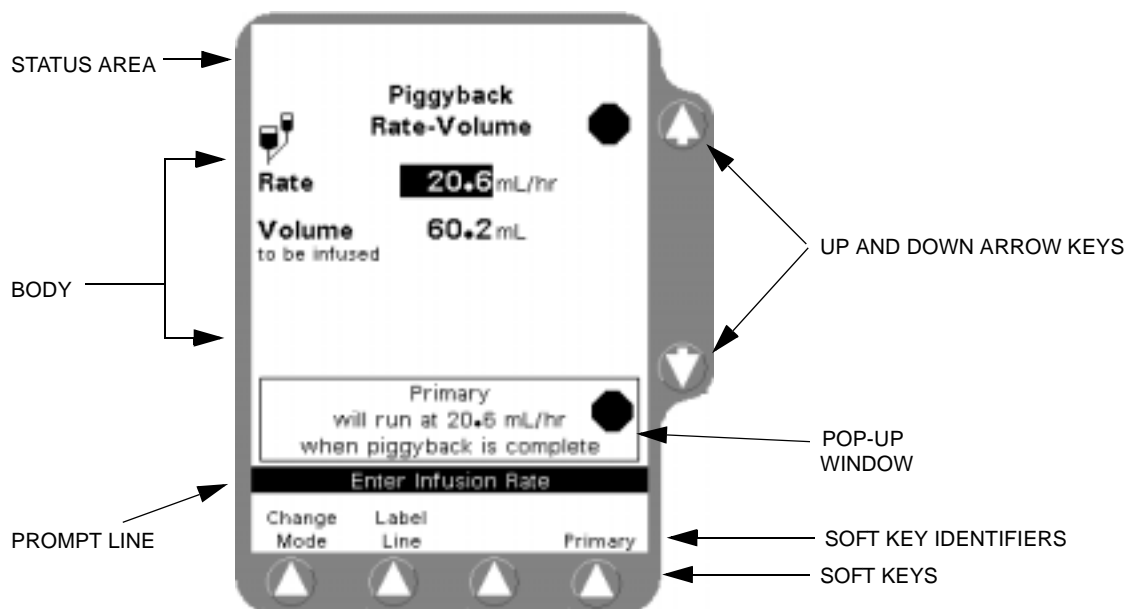

2

Figure 2-2 Main Display

Area	Function
Status Area	This highlighted area at the top of the display shows alert, alarm, and failure conditions.
Body	The middle of the display area is used for selecting, programming, and displaying running conditions.
Prompt Line	The single line of highlighted type just below the body provides prompts for user action.
Soft Keys	The four keys located below the display screen are referred to as soft keys. Only the key labels applicable to the current activity are displayed.
↑↓ (Up and Down) Arrow Keys	These keys are used to select programming fields or to perform actions.
Pop-Up Window	This message box is used to provide additional information that does not require user response.

Pump Module

The Pump Module is located below the Main Body.

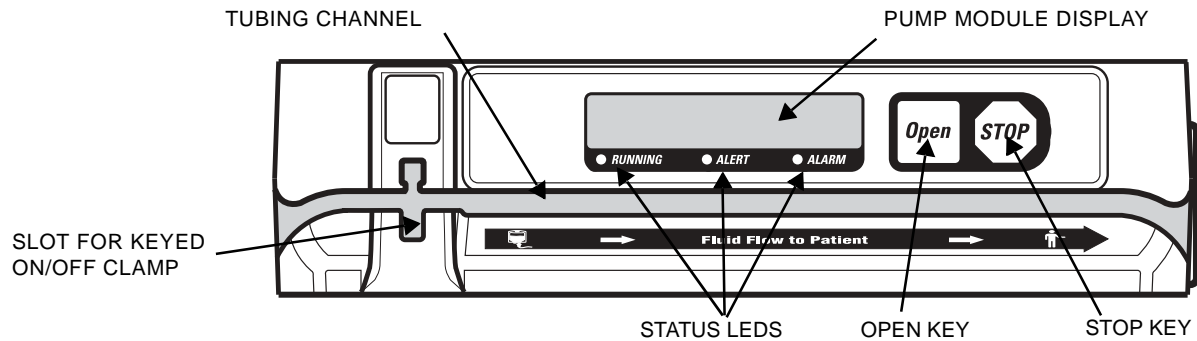











Figure 2-3 Pump Module

The eight character display is used for status information messages. The message displayed during normal pumping depends upon the specific options selected by your care site.

Note: If the pump is running on battery power with no alarm or alert, the pump module display is blank to conserve energy.

Message Display	Description
Pump Module Display	
	<p>Four message options are available for display during routine infusion. Your pump will display one of the following:</p> <ul style="list-style-type: none"> • Rate • Time Remaining • Volume Infused, or • Label
	<p>Displays the activity of the pump module during specific operations such as tube loading.</p>
	<p>Displays alarm or alert conditions when they occur.</p>

Key	Description
	When there is no administration set in the pump, pressing this key opens the loading mechanism so you can load the administration set. When there is an administration set in the pump, pressing this key opens the loading mechanism so you can remove the administration set.
	With the pump running, pressing this key stops the infusion.
Fluid Flow Symbol	Description
	
	This symbol is located below the left side of the tubing channel to indicate the upstream side of the pump. When loaded correctly, the tubing from the container must enter the left side of the pump.
	This symbol is located below the right side of the tubing channel to indicate the downstream side of the pump. When loaded correctly, the tubing going to the patient must exit the right side of the pump.
	These arrows indicate the direction of fluid flow.
LEDs	Description
	<p>RUNNING LED</p> This green LED remains on continuously during an infusion.
	<p>ALERT LED</p> This yellow LED remains on continuously during an alert condition, if there are no active alarms.
	<p>ALARM LED</p> This red LED flashes on and off during an alarm condition and remains on continuously during a failure condition.

2

Rear Panel

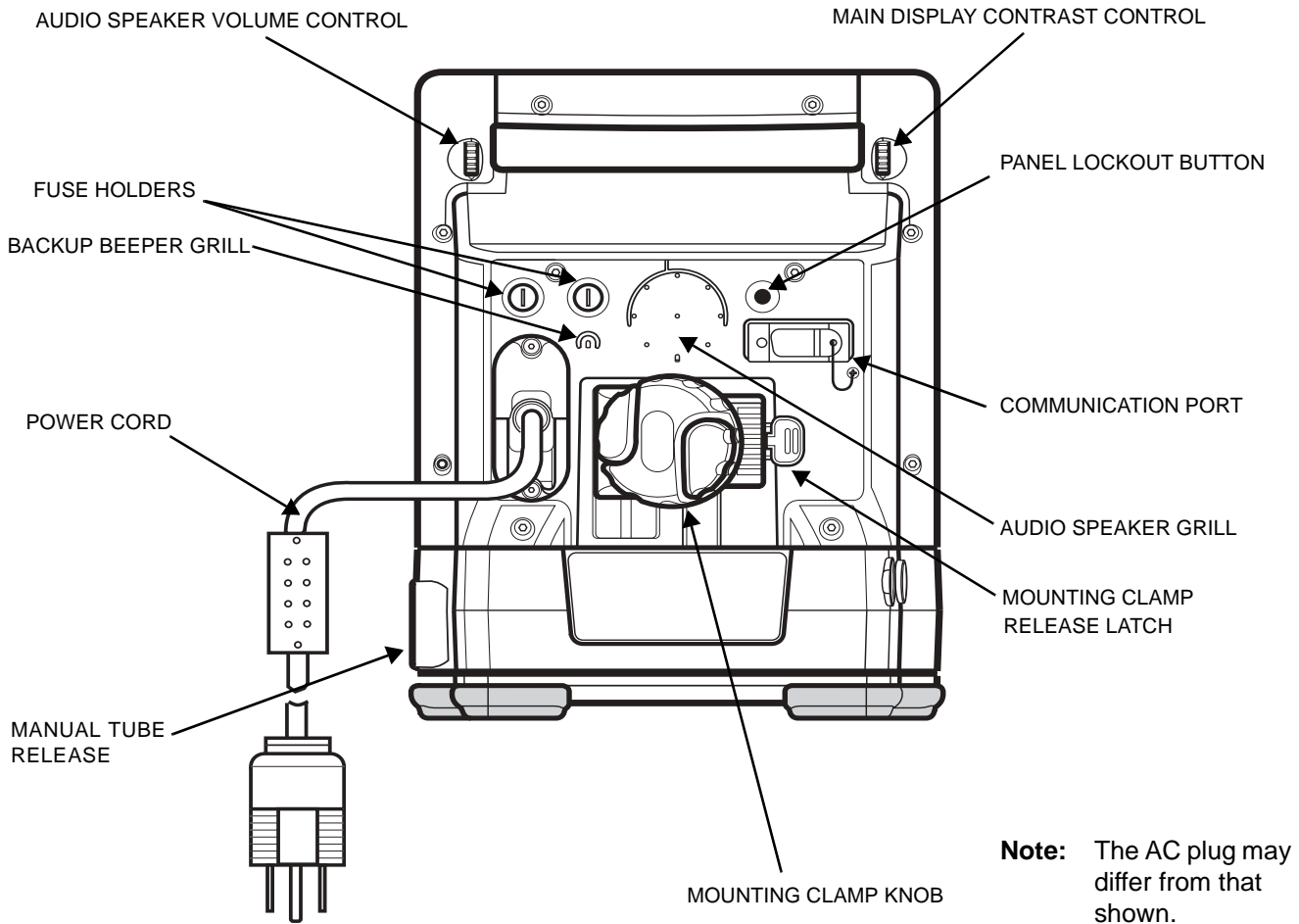

Figure 2-4 Rear View

Item	Description
Communication port	An RS232/RS423 interface enables optional nurse call and communication functions. The pump can be monitored by a computer. Refer to the <i>Colleague Pump Computer Monitoring Guide</i> , available from your Baxter customer representative, for information on computer monitoring.
Fuse holders	The pump's fuses are located inside.
Volume and Contrast Controls	Thumbwheels for increasing and decreasing the audio volume and display contrast settings.
Audio speakers	Speakers that generate alert and alarm tones.
Mounting clamp and knob	Secures the pump to a pole, bed, or other suitable object.
Manual tube release	Flip-out knob for manual tube unloading.
PANEL LOCKOUT button	Disables/enables front panel keys.

Programming Screens

Programming screens have fields where you enter infusion program values. The programming screens for each pump mode are different because each mode requires you to program different information.

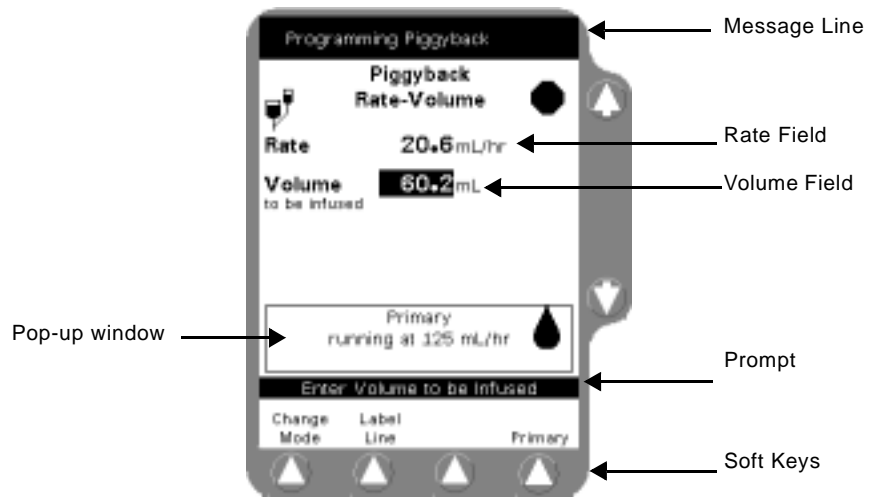

Figure 2-6 Programming Screen Information

Pop-Up Windows

Pop-up windows are message boxes containing information that does not require user response (Figure 2-6).

Menus



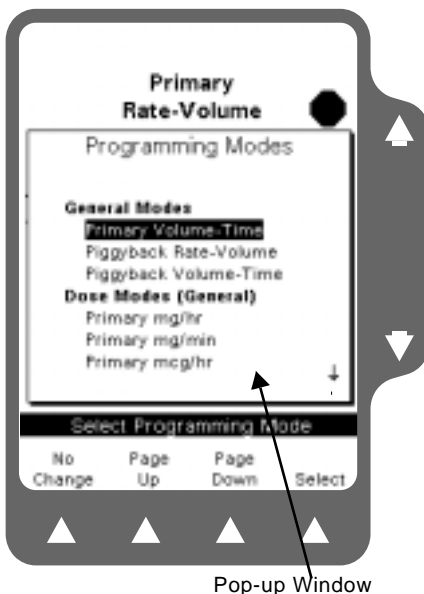





In some situations, a menu containing additional selections is provided (Figure 2-7). To select a menu item, use the $\uparrow\downarrow$ keys to highlight the desired selection, then press the **Select** soft key.



Pop-up Window

Figure 2-7 Programming Modes Menu

Main Display Icons

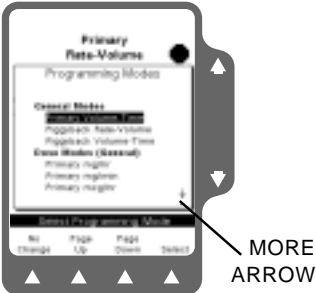
Icon	Description
	<p>This icon indicates that air has been detected by the air sensor.</p>
	<p>This icon indicates that air has exited from the air sensor area and fluid is now detected.</p>
	<p>This icon is displayed during power-on self test and when requested from the Options Menu. The number of filled boxes below the battery is an approximate indication of the charge remaining in the battery. As the battery discharges, the number of filled boxes decreases. Two or fewer filled boxes are displayed when battery charge is depleted to the Battery Low alert level. No boxes are filled when the charge is depleted to the Battery Depleted alarm level.</p>
	<p>The solid drop icon is displayed when the pump is running. On the Main Display screen, the drop moves and is displayed as an outline.</p>
	<p>The flow check icon indicates approximate level of downstream occlusion. The greater the restriction of fluid flow, the greater the number of solid arrows displayed.</p>
	<p>This icon is displayed when the screen is displaying piggyback information.</p>
	<p>This icon is displayed on the Programming screen when the pump is stopped.</p>
	<p>This icon is displayed on the Main Display screen when the pump is stopped.</p>
	<p>When the keypad is locked, the Lock icon is displayed between the second and third soft keys. The following keys remain available when the keypad is locked so you can view infusion status information: Main Display, Back Light, Volume History, Primary, Piggyback and Options.</p>
	<p>When a list contains more information than can be displayed on a single screen, an arrow is displayed in the lower right and/or the upper right corner. Use the Page Up and Page Down soft keys to page through the list.</p>

Label Location

The pump's labels provide additional information about the pump. Figure 2-8 shows the location of the pump's labels. If any labels are missing or damaged, contact your local Baxter Service Center for replacement information.

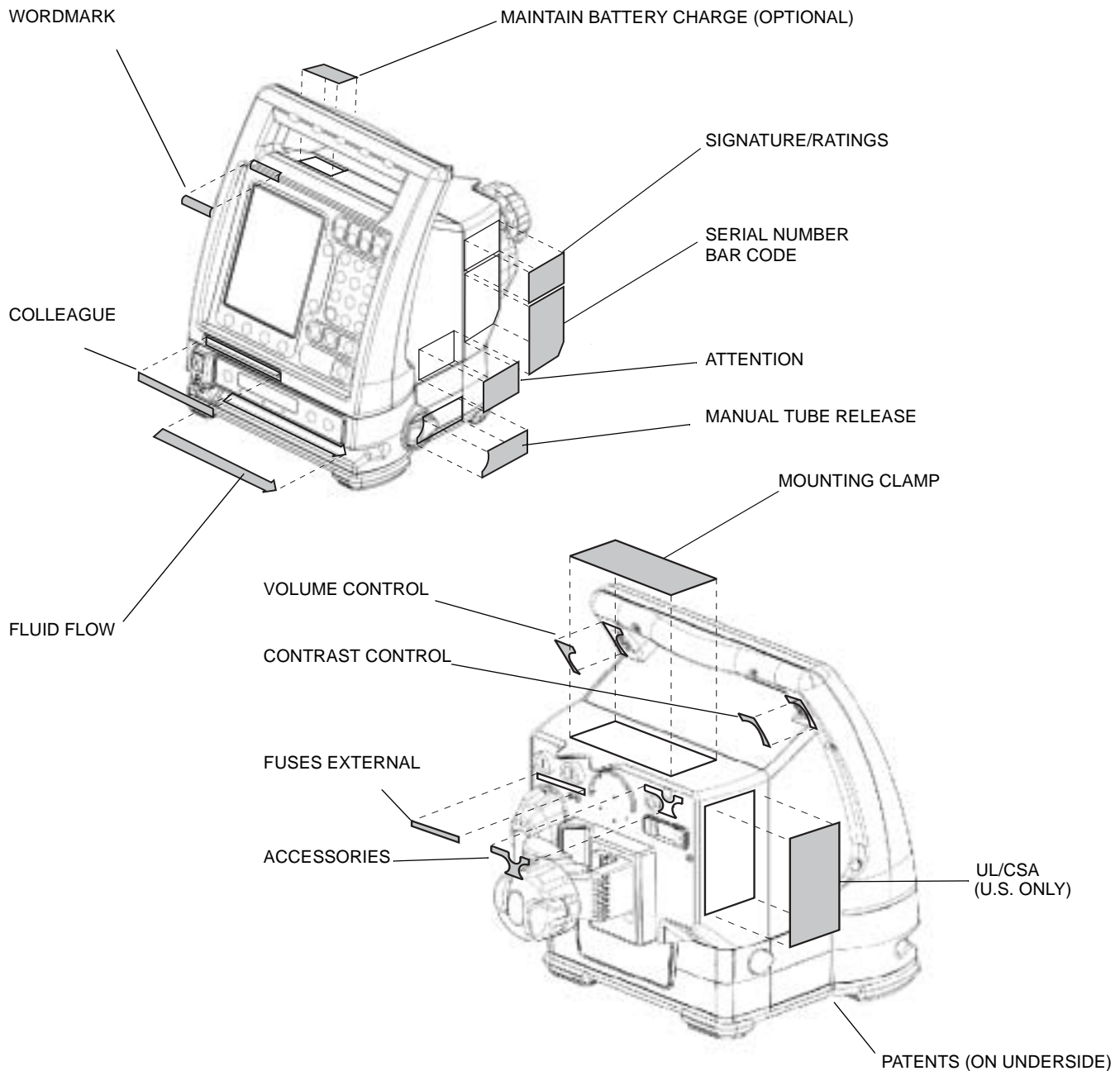

Figure 2-8 Location of Pump Labeling

Basic Operation

Setting Up the Pump

Initial Installation

! WARNING !

To ensure safe and proper operation, read the manual and any instructions accompanying disposables or accessories before operating this device.

Note: BEFORE INITIALLY POWERING ON THE PUMP, CHARGE THE BATTERY FOR AT LEAST 12 HOURS. A COMPLETE CHARGE MAY TAKE LONGER THAN 12 HOURS.

1. Plug the power cord into a 100-120 VAC 50/60 Hz or 220-240 VAC 50/60 Hz outlet, unless temporary battery operation is required.

Note: The plug icon illuminates when the pump is plugged into the outlet, indicating that the battery is charging.

Note: If the pump is not plugged into an outlet and the pump is powered on, the battery icon illuminates, indicating that the pump is operating on battery power.

3

Mounting Clamp Overview

The Colleague Pump is equipped with a multi-position mounting clamp. This design provides maximum flexibility when using the pump during transport or in situations where standard pole mounting is difficult or undesirable. The mounting clamp can be attached to an IV pole, headboard or footboard.

Caution

Ensure pump is mounted where main body is easily accessible and administration set can be loaded without being stretched or kinked.

Caution

Ensure that the headboard or footboard is stable, secure, and has a depth greater than 1.91 cm (3/4 inches) and height of at least 5 cm (2 inches).

Caution

To avoid personal injury, ensure that the IV pole is stable and secure. Ensure that the pole is able to support the pump, along with any other devices, without tipping or falling. The pole diameter should be between 0.95 and 3.81 cm (3/8 inch and 1-1/2 inches).

Caution

The pump should never be placed on the bed alongside the patient.

Mounting the Pump on an IV Pole

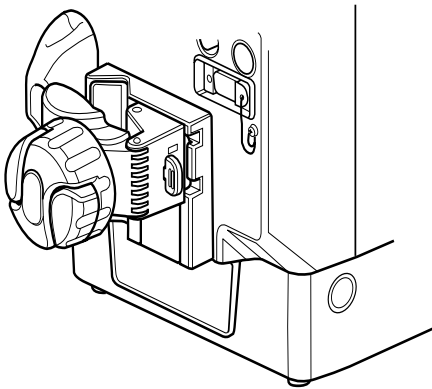

Figure 3-1 Pole (vertical) Mount

Note: To help loosen the mounting clamp knob, flip open and use the two wing-shaped extensions on the knob.

1. Check to see if the clamp bracket is positioned for pole mounting or other vertical applications as in Figure 3-1.

If so, continue with Step 2; otherwise, see “Changing the Mounting Bracket Orientation,” 3-3.

2. Attach mounting clamp by positioning the hinged clamp arm over the chosen fixture. See “Mounting Clamp Overview,” 3-1.
3. Turn the mounting clamp knob clockwise to close the clamp arm. Tighten until secure.

Mounting the Pump on a Headboard

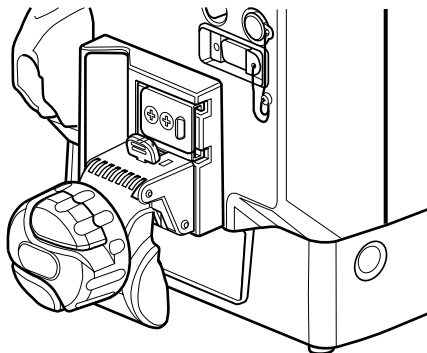

Figure 3-2 Headboard (horizontal) Mount

Note: To help loosen the mounting clamp knob, flip open and use the two wing-shaped extensions on the knob.

1. Check to see if the clamp bracket is positioned for headboard mounting or other horizontal applications as in Figure 3-2.

If so, continue with Step 2; otherwise, see “Changing the Mounting Bracket Orientation,” 3-3.

2. Attach mounting clamp by positioning the hinged clamp arm over the chosen fixture.
3. Turn the mounting clamp knob clockwise to close the clamp arm. Tighten until secure.

Changing the Mounting Bracket Orientation

The instructions and Figure 3-3 illustrate how to change the orientation from a pole mount (vertical) to a headboard (horizontal) mount. The procedure for changing from a horizontal mount to a vertical mount is similar, except that the positions of the clamp and plate cover are the reverse of what is shown in the figures.

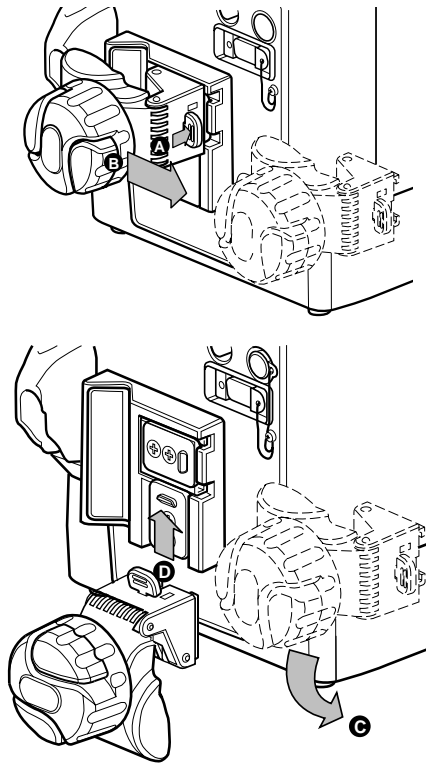

1. Press down and hold the latch (A in Figure 3-3) to release the mounting clamp from the plate.
2. Grasp the mounting clamp knob and slide the clamp off of the bracket (B in Figure 3-3).
3. Rotate the clamp counter-clockwise 90° (C in Figure 3-3) until the open end of the clamp is towards the floor (see clamp in Figure 3-2).
4. Slide the clamp up onto the plate until you hear the clamp lock into place (D in Figure 3-3). The clamp should now be positioned as in Figure 3-2. Test to make sure it is secure.
5. Continue with Steps 2 and 3 of the appropriate mounting procedure.

Figure 3-3 Changing the Mounting Bracket Orientation

Recommended Administration Sets

In EEC Countries

! WARNING !

EEC COUNTRIES: Use only Baxter “Green Label” C96XX administration sets equipped with keyed On/Off Clamps. There are risks associated with using anything other than the recommended administration sets with this device.

Use only C96XX administration sets (where XX = set identifiers) with batch codes 97H and newer, where 97 is the year and H is the month (August) of manufacture.

Example:

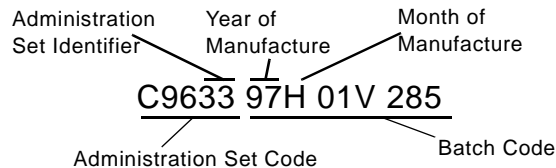

Note: Administration sets' maximum pressure is 3000 mmHg (58.25 psig).

In Latin America

! WARNING !

LATIN AMERICA: Use only the following administration sets:

Baxter “Green Label” C96XX administration sets equipped with keyed On/Off Clamps, or

Baxter standard administration sets equipped with keyed On/Off Clamps that have an "s" after the code number, or are labeled as pump compatible. If you have questions about administration set compatibility, contact the Baxter Product Information Center at the number shown on the administration set labeling. There are risks associated with using anything other than the recommended administration sets with this device.

In the United States

! WARNING !

U.S.: Use only Baxter standard administration sets equipped with keyed On/Off Clamps that have an "s" after the code number, or are labeled as pump compatible. If you have questions about administration set compatibility, contact the Baxter Product Information Center at the number shown on the administration set labeling. There are risks associated with using anything other than the recommended administration sets with this device.

Preparing the Primary Infusion Container and Set

! WARNING !

Always read and follow the instructions which accompany the source container and administration sets you are using. Carefully follow the instructions for loading, removing, and reloading the set, as well as the recommended set change interval. Set use should not exceed the label set change interval or 72 hours, whichever is less.

1. Prepare the primary infusion container following the manufacturer's directions for use.
2. Attach an appropriate Baxter administration set to the solution container and prime the administration set following the directions for use.
3. Ensure all air is expelled from the administration set.
4. Close the regulating clamp.

OR

1. Use the optional Prime function.

Powering On the Pump

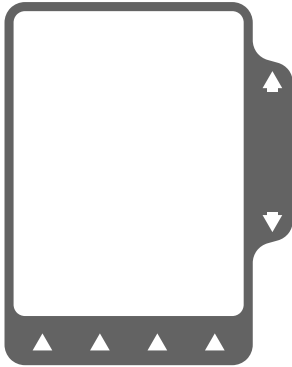

Figure 3-4 All Light Screen

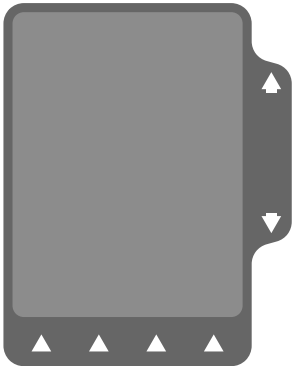

Figure 3-5 All Dark Screen

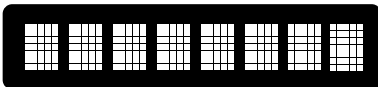

Figure 3-6 Pump Module Display



Figure 3-7 LEDs

Note: Self-diagnostic testing occurs whenever the pump is powered ON.

1. With the pump plugged in, press the **ON/OFF CHARGE** key. Self-diagnostic tests begin.
 - a. First, the Main Display and pump module display turn on.
 - b. The entire Main Display becomes light (Figure 3-4).
 - c. The entire Main Display becomes dark (Figure 3-5).
 - d. All 8 digits of the pump module display light fully, then turn off completely, then display the word **CLOSED** (Figure 3-6).
 - e. All the LEDs and icons light briefly (Figure 3-7). The plug icon lights and remains lit.
 - f. The backup beeper sounds twice.
 - g. The speaker sounds once.

Note: If any of the following occur during self-diagnostic testing, the pump must be removed from service and inspected by authorized personnel:

Dark spots or lines on Main Display while display is all white.

Light spots or lines on Main Display while display is all dark.

Portions of pump module display do not light.

LEDs or the plug icon are not lit, or the battery icon is lit.

Backup beeper is not heard twice during self-diagnostic test.

Audible speaker is not heard during self-diagnostic test.



Figure 3-8 Power On Screen During Self-Test

2. When the main body display, pump module LED, and speaker tests are complete, the Power On screen (Figure 3-8) is displayed during the remaining self-diagnostic tests.
3. On completion of all self-diagnostic tests, the Power On screen changes to the display shown in Figure 3-9, Power On Screen After Self-Test.
4. The soft keys available on this screen depend on the configuration options selected for the pump:
 - If the **New Patient** soft key is present, information from a previous program is still retained in memory. To clear all programming memory and volume history, press the **New Patient** soft key.
 - Pressing the **Change Personality** soft key changes the display to the Pump Personality selection screen where available preconfigured pump parameters can be selected. See “Personality Feature Sets,” 5-23 for additional information.

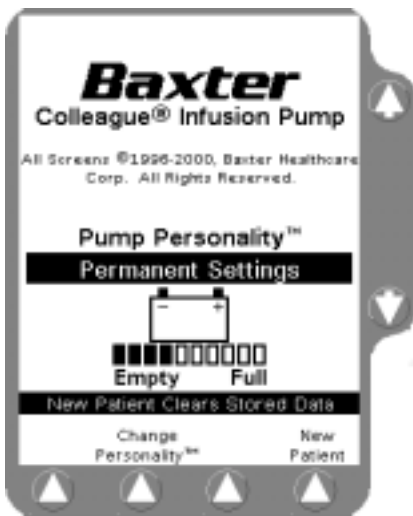

Figure 3-9 Power On Screen After Self-Test

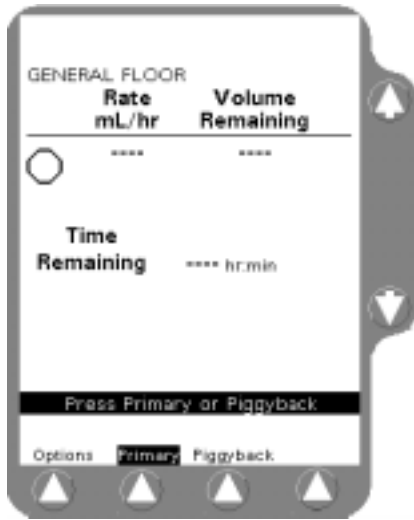

Figure 3-10 Main Display After Self-Test

- From the Power On Screen After Self-Test (Figure 3-9), press the **Main Display** key (top right of front panel) to view the Main Display screen (Figure 3-10).

Note: If no keys are pressed, the pump will automatically display the Main Display screen after approximately 10 seconds.

Note: Following a pump failure, the Manual Tube Release mechanism must be reset (see “Using the Manual Tube Release,” 3-11) before the pump can be powered off. For instructions on resetting the Manual Tube Release, see “Resetting the Manual Tube Release,” 3-12.

Powering Off the Pump

! WARNING !

While the Colleague Pump automatically closes the keyed On/Off Clamp, always close the regulating clamp on the administration set before removing the administration set from the pump. See “Unloading the Administration Set,” 3-10 for detailed instructions.

- Press the **ON/OFF CHARGE** key to power off the pump.

Note: The **ON/OFF CHARGE** key is disabled if the front panel is locked. Press the PANEL LOCKOUT button on the back of the pump to unlock the panel. Then press the **ON/OFF CHARGE** key again to power off the pump.

Note: The pump cannot be powered off if a Tube Misload alarm is active. This alarm occurs if the **ON/OFF CHARGE** key is pressed before the pump finishes the loading or unloading process.

Loading the Administration Set



Figure 3-11 Pump Module Keys

1. Press the **Open** key (Figure 3-11). The automatic tube loading mechanism opens so the administration set can be loaded.

Note: If the administration set is not loaded after the **Open** key has been pressed, the mechanism closes automatically after 60 seconds.

Note: The pump must be powered on to load the administration set (see “Powering On the Pump,” 3-6).

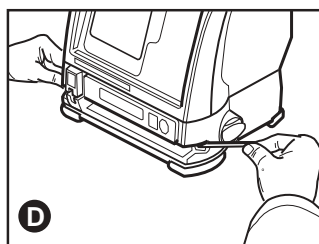
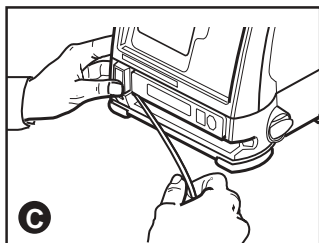
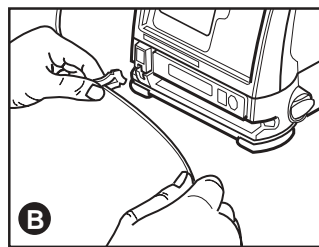
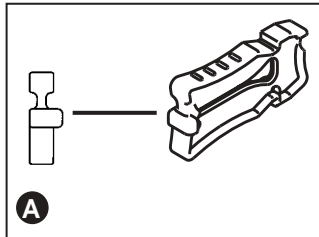

Figure 3-12 Loading the Administration Set

2. Ensure that the keyed On/Off Clamp occludes the administration set and is positioned so that the projection on the clamp end extends to the right (Figure 3-12A). When the mechanism is fully opened and **STOPPED** is displayed on the pump module, insert the keyed On/Off clamp into the slot (Figure 3-12B).
3. Pull the administration set taut and slide it all the way into and along the tubing channel (Figure 3-12C).
4. When the pump detects the administration set, the mechanism automatically pulls in the keyed On/Off Clamp, then closes and loads the administration set into the pumping mechanism (Figure 3-12D).
5. After the administration set is loaded, confirm that the tubing entering the pump module on the left side is going to the source container. The proper patient and source container orientation and the direction of fluid flow are shown on the Fluid Flow label below the tubing channel.
6. Open the regulating clamp. Verify that no solution is flowing (no drops falling in the drip chamber and/or no flow from the end of the administration set).
7. Attach the administration set to the patient access site.

3

Caution

If flow is observed when tubing is loaded but the pump is not running, close the regulating clamp immediately. Ensure that all steps have been properly performed. If flow is still observed, remove the pump from service and contact a Baxter authorized service person.

Unloading the Administration Set



1. If the pump is running, press the **STOP** key on the pump module to stop the pump.
2. Close the regulating clamp on the administration set.
3. Press the **Open** key.

The mechanism automatically closes the keyed On/Off Clamp and opens the tubing channel so you can remove the administration set. Ensure the tubing channel is completely open (arrow displayed on the pump module display) before performing step 4.

! WARNING !

While the Colleague pump automatically closes the keyed On/Off Clamp, always close the regulating clamp on the administration set before removing the administration set from the pump.

Note: If the pump is powered off, you must first power on the pump. See "Powering On the Pump," 3-6.

4. When the mechanism has opened completely, (arrow displayed on the pump module display) grasp the administration set on both sides of the pump and remove the administration set from the tubing channel. The mechanism closes automatically 60 seconds after the administration set has been removed.

! WARNING !

The administration sets should be disposed of in an appropriate manner, considering the nature of the residual fluid that may be contained within, in accordance with the hospital disposal practices.

Note: If the loading mechanism is disabled (for example, the battery has depleted), see "Using the Manual Tube Release," 3-11 for instructions on unloading the administration set manually.

Using the Manual Tube Release

Note: Use Manual Tube Release only when the Tube Loading Mechanism is NOT functioning, or if a channel failure occurs.

Note: Never use the Manual Tube Release to load the administration set.

1. Close the regulating clamp on the administration set.
2. Locate the Manual Tube Release mechanism on the right side of the pump, as you face the front panel.
3. Push and grasp the release tab (see Figure 3-13A), turning it out (see Figure 3-13B).
4. Rotate the tab counterclockwise to its stop (see Figure 3-13C). This closes the On/Off clamp and opens the pump mechanism.
5. Remove the administration set from the pump.

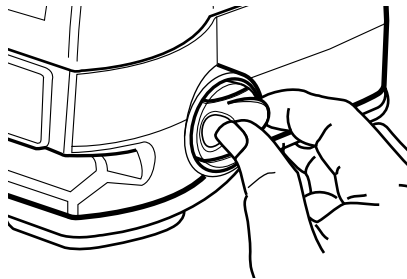

A

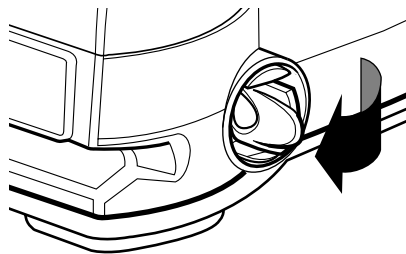

B

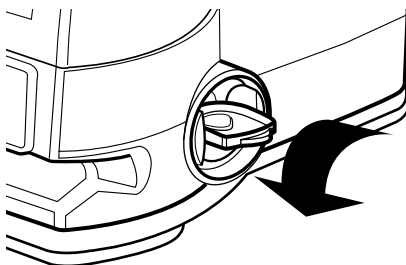

C

Note: The Reset Manual Tube Release screen may not display if a pump failure has occurred.

If the pump is on with no administration set in the tubing channel, a Reset Manual Tube Release alarm occurs and the Reset Manual Tube Release screen is displayed (Figure 3-14).

If the pump is on and the administration set remains in the tubing channel, a Close Regulating Clamp alarm occurs first. Close the regulating clamp, remove the administration set and then reset the mechanism.

3

Figure 3-13 Using the Manual Tube Release

Resetting the Manual Tube Release

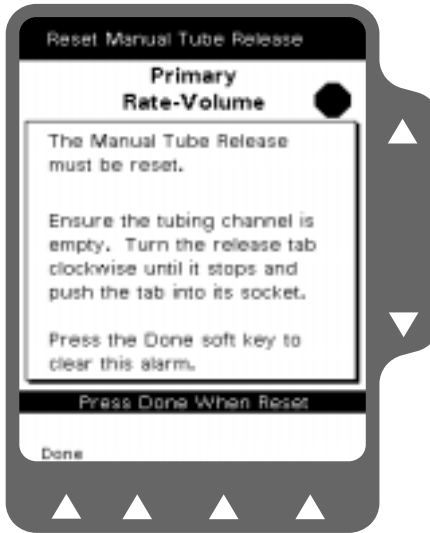

Figure 3-14 Reset Manual Tube Release Screen

If a channel failure occurs and you attempt to power off the pump without first resetting the Manual Tube Release, the Reset Manual Tube Release pop-up is displayed.

Reset the Manual Tube Release as follows:

1. Ensure there is no administration set or foreign object in the tubing channel.
2. Turn the release tab (Figure 3-13A) clockwise to its stop and push the tab into its socket.
3. The **Done** soft key is displayed when the Manual Tube Release is reset. Press the **Done** soft key to clear the alarm.

Note: If you use the Manual Tube Release following a channel failure to remove the administration set, the pump cannot be powered off until the Manual Tube Release has been reset. A Reset Manual Tube Release pop-up message will be displayed.

Note: If three unsuccessful attempts to reset the Manual Tube Release are made, a channel failure occurs. You cannot use the pump until the Manual Tube Release is reset and the pump is powered off and back on.

Programming a Primary Rate-Volume Infusion

1. When the Main Display screen is shown, press the **Rate** key (Figure 3-15).



Figure 3-15 Main Display Screen

The display then changes to the Rate-Volume programming screen and the Rate field is highlighted (Figure 3-16).

2. Program the desired flow rate (in mL/hr) using the keypad (Figure 3-16).

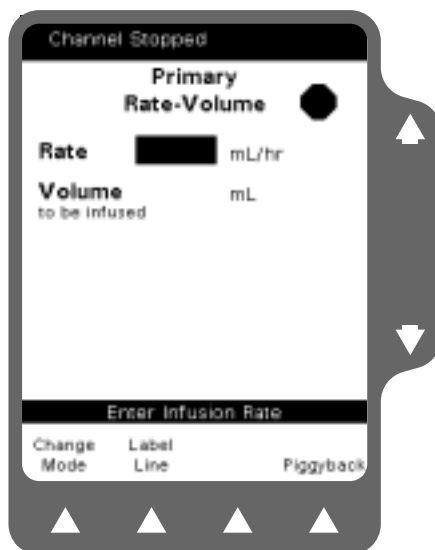

Figure 3-16 Rate-Volume Programming Screen

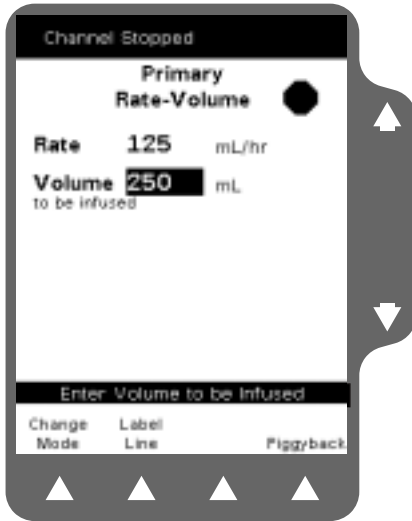

Figure 3-17 Enter Volume to be Infused

3. Press the **Vol** key or use the $\uparrow\downarrow$ keys to highlight the Volume to be Infused field for programming (Figure 3-17).
4. Program the desired Volume to be Infused using the keypad.
5. When all programming steps have been completed, always verify programmed information prior to starting the pump.



Figure 3-18 Main Display, Primary Running

6. To start the infusion, press the **START** key.

The RUNNING LED on the Pump Module lights and a moving drop icon is shown on the Main Display (Figure 3-18).

Note: If you enter an incorrect value during programming, press the **CLR** key to clear the field, then enter the correct value.

If you program values that exceed the allowable range available, HIGH or LOW will be displayed and an Out of Range alarm will occur when the **START** key is pressed.

If the rate and volume entered results in a time duration exceeding 99:59, the time duration will be displayed as **:**.

Note: Programming values for each field are not stored until the $\uparrow\downarrow$, **Rate**, **Vol**, **Main Display**, **Change Mode**, **Label Line**, **Primary**, **Piggyback**, **Confirm Settings**, **START** key, or **Volume History** key (if pump is stopped) is pressed.

Note: Programming values for each field are also stored when the pump is in stop mode and then powered off.

Completing or Stopping a Primary Infusion

Completing an Infusion



Figure 3-19 KVO Display

1. When the volume remaining reaches zero, the pump automatically enters a KVO (Keep Vein Open) alert mode (Figure 3-19).

During this alert mode, the pump continues infusing at a preconfigured KVO rate or at the programmed rate, whichever is less. See “Configurable Options,” 9-1.

2. To exit the alert, press the **STOP** key and program the pump for the next infusion if appropriate, or power off the pump.

Stopping an Infusion Before Completion



Figure 3-20 Infusion Stopped

1. To stop an infusion before completion, press the **STOP** key on the Pump Module.

A stop icon will be displayed on the Main Display and the RUNNING LED will no longer be illuminated (Figure 3-20).

Note: If the pump is not restarted within two minutes, or no keys are pressed for 30 seconds, a Channel Stopped Alert will sound.

Note: The infusion stops if an alarm occurs while the pump is running or if the **ON/OFF CHARGE** key is pressed while running.

2. To restart the infusion, press the **Primary** or **Piggyback** soft key to access the appropriate programming screen. Press the **START** key.

Programming a Piggyback Infusion

Piggyback Infusion Overview

This optional programming function allows the pump to deliver fluid from a second source container at a rate and volume that is independent of the primary infusion. When the piggyback is complete, the pump automatically switches to the programmed primary rate if a primary infusion exists.

! WARNING !

EEC COUNTRIES: Use only Continu-Flo “Green Label” C96XX administration sets as the primary fluid line when administering a secondary medication.

ELSEWHERE: Use only Continu-Flo standard administration sets equipped with keyed On/Off Clamps as the primary fluid line when administering a secondary medication.

See “Recommended Administration Sets,” 3-4. Carefully follow the directions on the primary and secondary administration set labels.

Piggyback Callback Alert Option

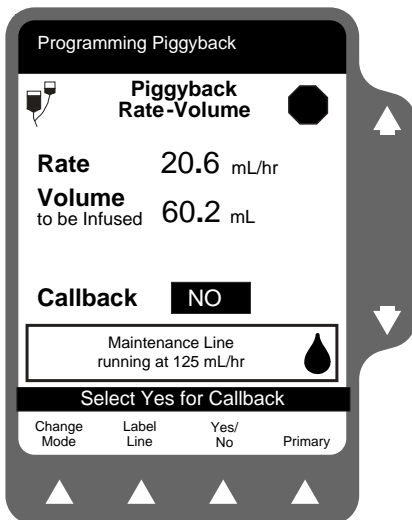

Figure 3-21 Select Callback Yes or No

This optional feature notifies the clinician that the piggyback infusion has been completed. When configured, an alert message can be displayed with an audible alert tone. On the piggyback programming screen, the clinician selects Yes or No for using the callback option (Figure 3-21). To cancel this alert, press the **Alarm Silence** key or any of the programming keys.

Note: You can program a piggyback infusion while a primary infusion is running. A Programming Piggyback alert message will be displayed with an audible alert tone.

Note: Piggyback infusions can be programmed and started if the primary rate and volume are blank or if the primary rate is valid and the volume remaining is zero. In this case, the pump reverts to KVO alert mode after the piggyback infusion has been completed.

Preparing a Piggyback Infusion Set

1. Prepare solution containers and administration sets.
2. Lower primary container using the hanger provided with the secondary set.
3. Load the Continu-Flo administration set into the pump as described in “Loading the Administration Set,” 3-9.
4. If desired, program the primary infusion as described earlier.

Programming a Piggyback Infusion

1. To program the piggyback infusion, press the **Piggyback** soft key on the Primary Programming screen (Figure 3-22).



Figure 3-22 Select Piggyback

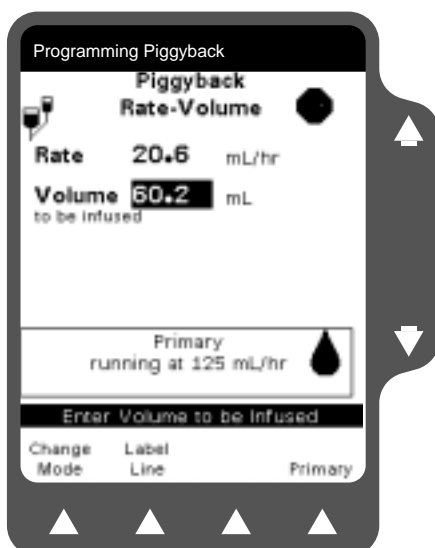

Figure 3-23 Enter Piggyback VTBI

2. Enter the piggyback rate and volume to be infused in the same manner as the primary (Figure 3-23).
3. After verifying the programming values, open the On/Off clamp on the secondary medication set and press the **START** key to begin the piggyback infusion.
4. Confirm that flow is occurring from the piggyback solution container by observing drops falling in the secondary drip chamber. Delivery from the primary container will occur when the piggyback container empties.
5. After the piggyback volume remaining reaches zero, the program automatically reverts to the primary rate or to a KVO rate if no primary infusion exists.

Stopping a Piggyback Infusion Before Completion

1. Close the On/Off clamp on the piggyback set.
2. Press the **STOP** key on the pump module (Figure 3-24).

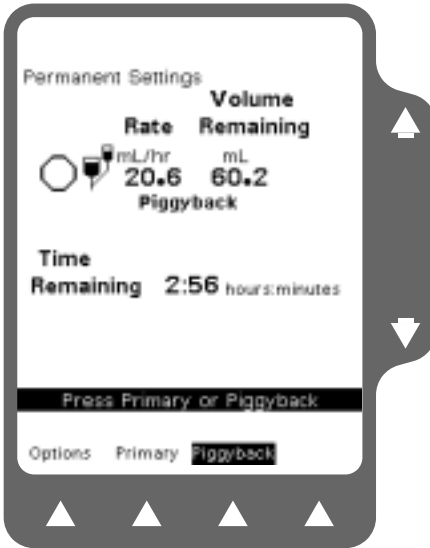

Figure 3-24 Piggyback Stopped

3. The primary infusion can be started by pressing the **Primary** soft key, then pressing the **START** key (Figure 3-25).

Note: To restart the piggyback infusion, press the **Piggyback** soft key followed by the **START** key.

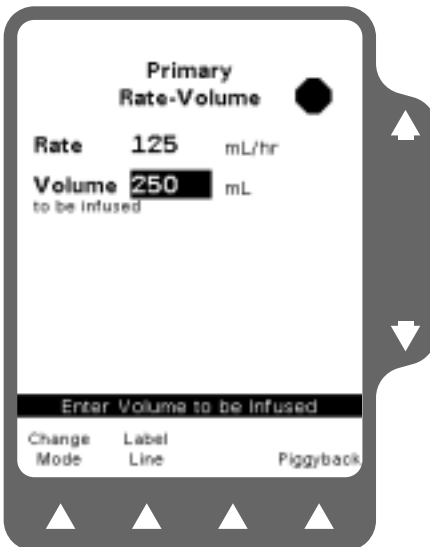

Figure 3-25 Press START

Changing the Flow Rate During an Infusion

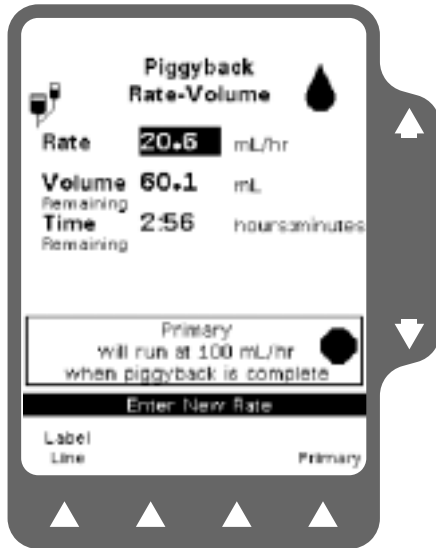

Figure 3-26 Enter New Rate

1. To change the primary or piggyback flow rate while infusing, press the **Rate** key. The Rate field is highlighted (Figure 3-26).
2. Enter a new value using the keypad.

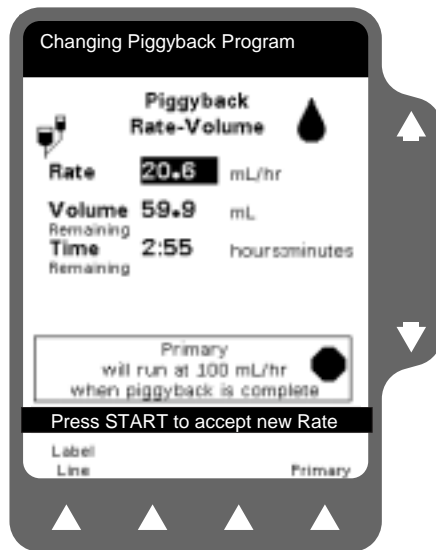

Figure 3-27 New Rate Running

3. Press the **START** key to save the change and begin infusing at the new rate (Figure 3-27).

Note: This procedure only changes the flow rate of the infusion currently shown on the display.

Note: Primary infusion programs cannot be altered when a piggyback infusion is running.

Volume History

Volume History Overview

This feature provides individual and combined volume infused information for the primary and piggyback. The volume(s) infused is retained until cleared, even if the pump is powered off. The current time and date are displayed at the top of the screen. The Volume History screen can be accessed from any screen, except configuration or service-related screens.

The last date and time the history was cleared and the total volume cleared are also displayed in the Last Volume Cleared field.

Using and Clearing Volume History

1. Press the **Volume History** key to display the Volume History screen.
2. Press the **Clear Volume** soft key to clear volume history, if desired.
OR

Press the **Done** soft key to return to the previous screen (Figure 3-28).

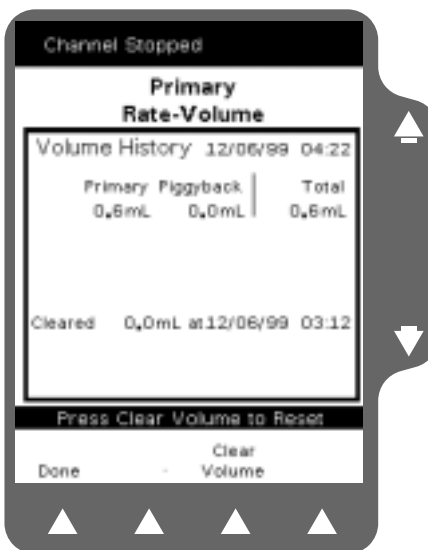

Figure 3-28 Volume History Screen

Note: The Volume History screen reverts to the previously displayed screen if no keys are pressed for 30 seconds.

Note: Volume history data is automatically cleared when you select a new patient at power on.

Note: Volume history data can be cleared while an infusion is running.

Note: Volume history data cannot be retrieved after it has been cleared. However, the last date, time and total volume cleared will still be displayed in the Last Volume Cleared field.

Panel Lockout

Panel Lockout Overview

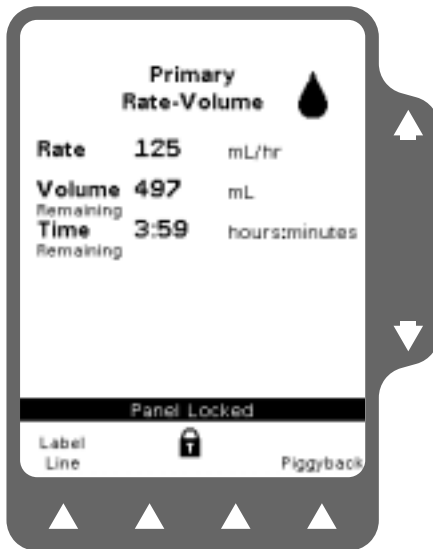

Figure 3-29 Primary Running, No Alarm or Alert

The Panel Lockout feature minimizes the potential for keypad tampering. It disables all the front panel keys except the **Main Display**, **Volume History**, and **Back Light** keys, and the **Options**, **Primary**, and **Piggyback** soft keys for viewing.

Panel Lockout can only be enabled from the Main Display or the Programming screen during an infusion with no alert conditions present (Figure 3-29).

Using Panel Lockout

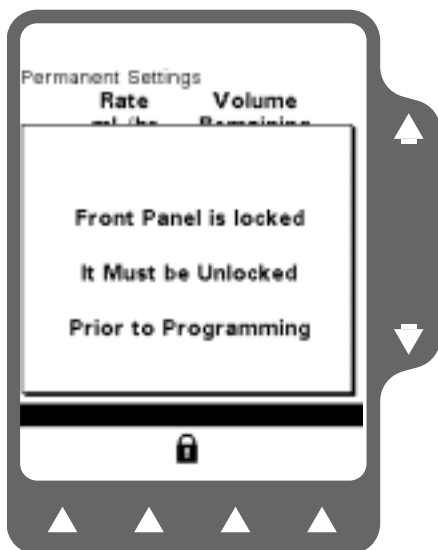

Figure 3-30 Front Panel Locked Invalid Key Pressed

To enable the manual panel lockout function, press the PANEL LOCKOUT button located on the back of the pump. The Lock icon is displayed between the second and third soft keys on the main display.

There is also an Auto Lock option available as a configurable option. This option automatically locks the front panel keys when the following conditions are true:

- an infusion is running
- no alarms or alerts are present
- no key presses have occurred in the last 2 minutes

To unlock the front panel, press the PANEL LOCKOUT button again.

Note: If disabled keys are pressed when the keypad is locked, the Panel Locked Pop-up is displayed (Figure 3-30).

Using the Options Menu

Overview

The Options Menu allows selection of the following functions:

- Flow check display
- View Current Personality Feature set
- Clinician override of downstream occlusion values
- View battery charge level
- Configuration/service functions (password required)

Pressing the **Options** soft key from the Main Display (Figure 4-1) accesses a menu as shown in Figure 4-2.

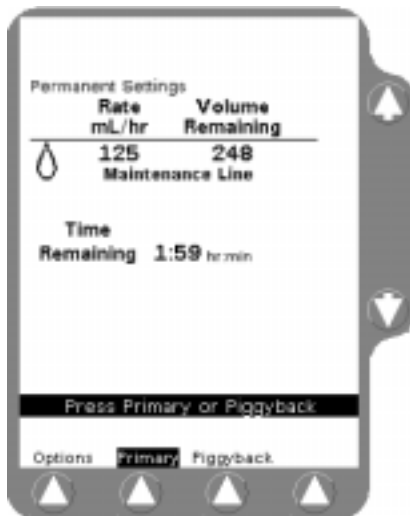

Figure 4-1 Main Display

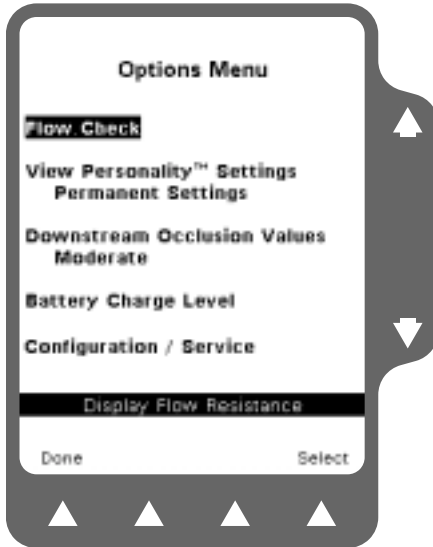

Figure 4-2 Options Menu

Use the $\uparrow\downarrow$ keys to highlight a function and then press the **Select** soft key to access it (Figure 4-2).

To exit the Options menu and return to the Main Display screen, press the **Done** soft key or the **Main Display** key.

Note: A password is required to access Configuration/Service.

Using Flow Check Display

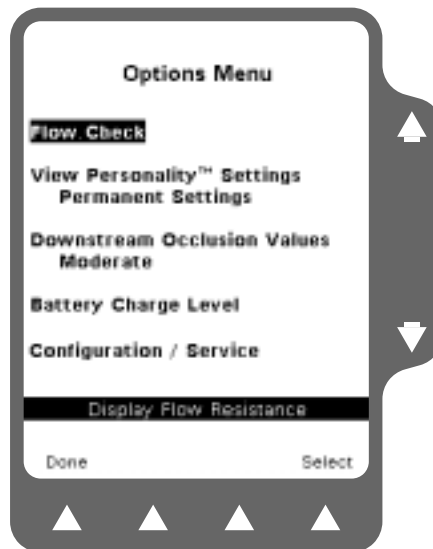

Figure 4-3 Options Menu

The flow check display feature provides a visual indication of downstream resistance to flow.

1. Press the **Options** soft key from the Main Display to access the Options Menu shown in Figure 4-3.
2. To exit the Options Menu, press the **Done** soft key, or the **Main Display** key to return to the Main Display screen.
3. Use the $\uparrow\downarrow$ keys to highlight Flow Check and then press the **Select** soft key.

The Flow Check display appears on the Main Display screen. Resistance to flow is indicated by the number of filled triangles. One filled triangle indicates normal conditions. When all of the triangles are filled, the resistance to flow has reached the pump occlusion alarm setting.

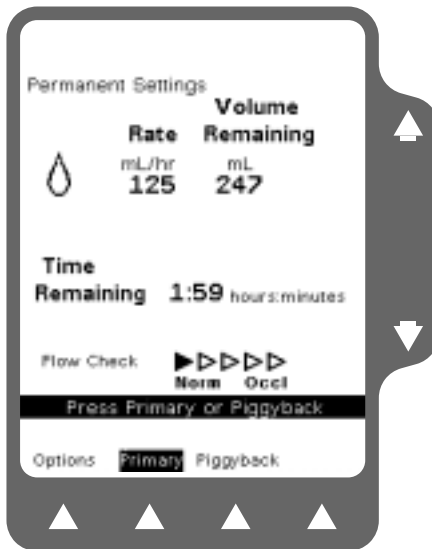

Figure 4-4 Flow Check Main Display

Note: When Flow Check is selected from the Options Menu, the status is displayed on the Main Display for 10 seconds (Figure 4-4).

Note: If Flow Check is enabled in the Configuration Utility, the Flow Check display appears on the Main Display screen whenever the pump is running.

Note: To check whether the back pressure from a downstream occlusion has decreased, view the Flow Check display when the pump is stopped. If all five triangles are filled, the downstream occlusion condition remains.

Viewing Current Pump Personality Feature Set

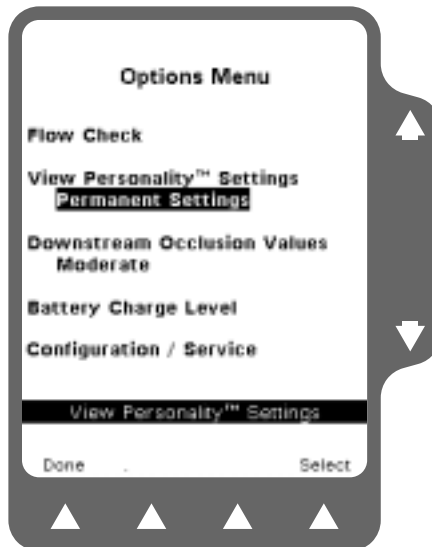

Figure 4-5 Highlight Name of Current Personality Feature Set

From the Options Menu, use the $\uparrow\downarrow$ keys to highlight the name of the current Personality feature set and press the **Select** soft key (Figure 4-5).

The resulting screens allow you to view all the configuration settings for the current Personality feature set.

See “Advanced Features,” 5-1 for additional information on selecting a Personality feature set.

If the current Personality feature set shown is Permanent Settings, custom configurations are not selected. See “Configurable Options,” 9-1 for factory settings.

Overriding the Downstream Occlusion Values

When enabled, the clinician can temporarily override the downstream occlusion values using the Options Menu.

1. Press the **Options** soft key from the Main Display to access the Options Menu.
2. To exit the Options Menu, press the **Done** soft key, or the **Main Display** key to return to the Main Display Screen.
3. Use the $\uparrow\downarrow$ keys to highlight the Downstream Occlusion Values setting and then press the **Select** soft key (Figure 4-6).

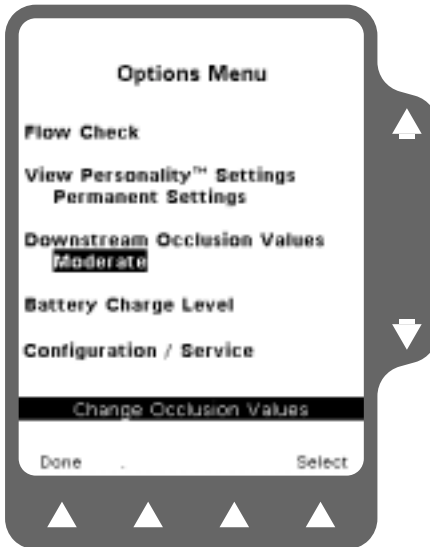

Figure 4-6 Downstream Occlusion Values Setting

If the Override option is enabled, the Downstream Occlusion Values pop-up is displayed (Figure 4-7). Downstream occlusion pressure alarm points for specific rate ranges are displayed, and the present setting is highlighted.

4. To display values in mmHg, press the **psig/mmHg** soft key. Press this key again to return the values to psig.
5. The occlusion values can be modified by using the $\uparrow\downarrow$ keys to highlight the new value range, then press the **Select** soft key to choose your selection.

Note: If the clinician uses the Options Menu to override the Downstream Occlusion values, the override values are not permanently saved. When the pump is powered off, the downstream occlusion values revert to the configuration defined by your care site.

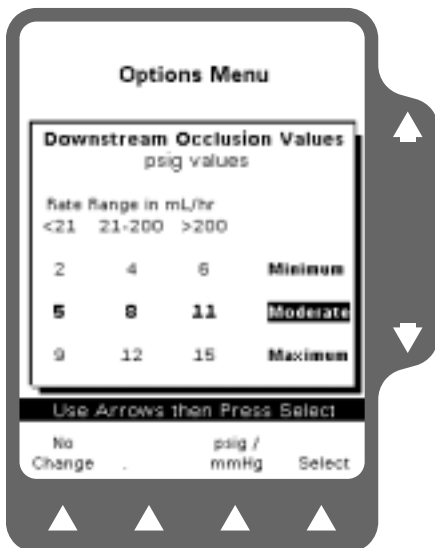

Figure 4-7 Downstream Occlusion Values Pop-Up

Auto Restart

When configured, the Auto Restart option enables the pump to automatically restart itself when a downstream occlusion has been corrected within approximately one minute after detection. The pump will continue to restart for up to nine occurrences (or as configured) before manual intervention is required.

Note: Selecting different downstream occlusion alarm values does not affect the Auto Restart feature.

Note: Pressing any key during a Downstream Occlusion alarm disables Auto Restart.

Checking Battery Charge Level

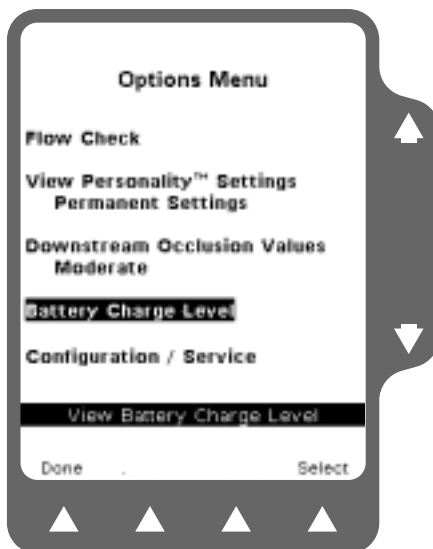

Figure 4-8 Options Menu

The Battery Charge Level display can be accessed through the Options Menu.

1. Press the **Options** soft key from the Main Display to access the Options Menu (Figure 4-8).
2. Use the $\uparrow\downarrow$ keys to highlight Battery Charge Level, then press the **Select** soft key to access it.

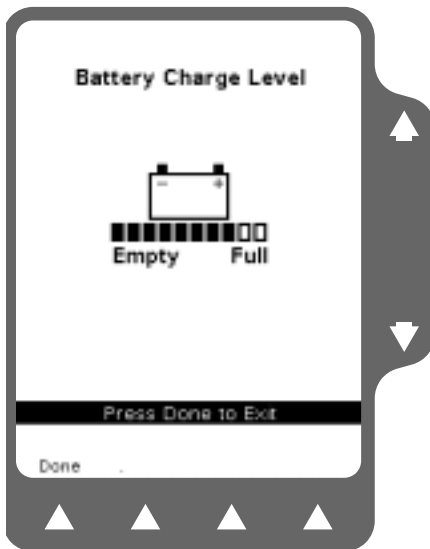

Figure 4-9 Battery Charge Level Indicator

A row of boxes is displayed below the battery icon (Figure 4-9). The number of filled boxes provides an approximate indication of the battery's charge level.

3. To exit the Options Menu, press the **Done** soft key, or the **Main Display** key to return to the Main Display screen.

Note: Ten filled boxes indicate that the battery is fully charged. As the battery discharges, the number of filled boxes decreases. Two or fewer filled boxes are displayed when the battery charge is depleted to the Battery Low alert level and none of the boxes are filled when the charge is depleted to the Battery Depleted alarm level.

Note: For additional information about battery care and maintenance, see "Maintenance and Storage," 7-1.

Using the Configuration/Service Function

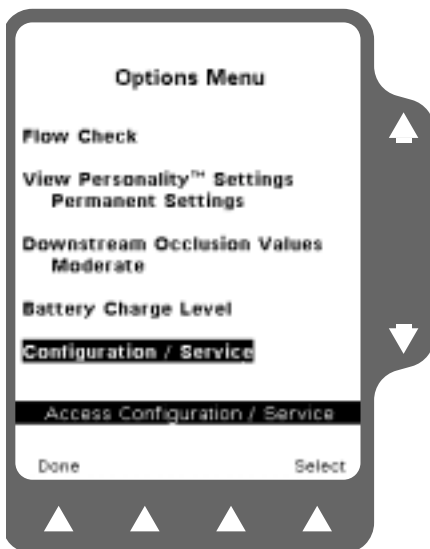

Figure 4-10 Options Menu Select Configuration/Service

Because this function is for use by authorized service personnel only, accessing this function requires a passcode (Figure 4-10). See the *Colleague Global Service Manual* for details.

Advanced Features

Overview

This chapter describes how to use the pump's advanced features available as configurable options. The actual availability of these features depends on the configuration used at your care site.

Advanced features include:

- Label Library
- Additional programming functions and utilities
- Using optional accessories
- Pump Personality Feature Sets

Label Library

Overview

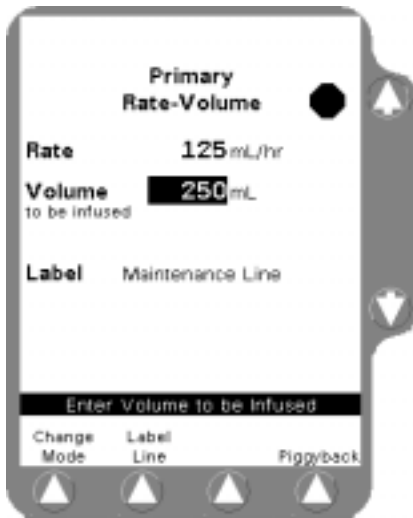

Figure 5-1 Programming Screen

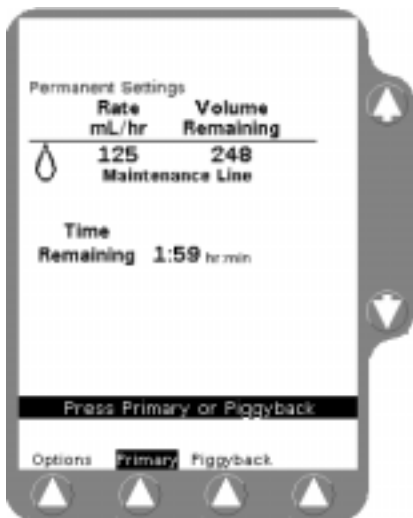

Figure 5-2 Main Display

This configurable feature allows you to display informational labels on the Programming screen (Figure 5-1) and Main Display screen (Figure 5-2), and an eight-character abbreviation of the label on the Pump Module display.

Labels are chosen from a list of pre-configured labels (if configured by the authorized personnel at your care site). When the feature is enabled, the user can select from the list of available informational medication and solution labels.

Up to 32 custom labels can also be programmed by authorized personnel if desired. The user can then select from the custom labels as well as the pre-configured labels. The custom labels appear in alphabetical order in the label list. Refer to the *Colleague Global Service Manual* for instructions on configuring custom labels.

Note: The Configuration/Service menu is not used for selecting a label for display. This menu is used by authorized personnel for enabling and disabling this feature and controlling label availability. See “Selecting a Label,” 5-3 for selecting labels for display.

Selecting a Label

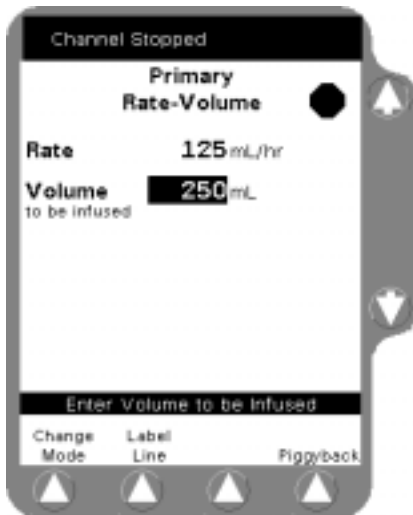

Figure 5-3 Label Line Soft Key on Programming Screen

If the pump is stopped or a label has not been previously selected and the feature has been enabled, a **Label Line** soft key is displayed on the Programming screen (Figure 5-3).

To select a label:

1. Press the **Primary** or **Piggyback** soft key to access the desired Programming screen (Figure 5-3).
2. Press the **Label Line** soft key. A list of labels and their abbreviations is displayed as shown in Figure 5-4.

Note: When the list consists of more than one page, use the **Page Up** and **Page Down** soft keys to view other pages.

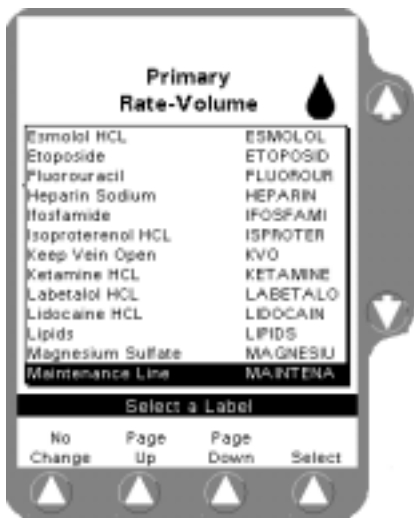

Figure 5-4 Label List

3. Highlight the label you want to select using the $\uparrow\downarrow$ keys, then press the **Select** soft key. When the **Select** soft key is pressed, the Programming screen is displayed, showing the label you selected (Figure 5-1).

Figure 5-4 shows the label Maintenance Line highlighted from one of the pages of available labels.

Note: To clear a label, use the same procedure, but select No Label from the label list.

Optional Dose Programming Functions

Overview

The configurable dose programming option lets you program a primary infusion using dose parameters. The dose can be programmed independent of patient parameters or based on body weight. The following dose parameters are allowed:

- Independent of patient parameters
 - mg/hr
 - mg/min
 - mcg/hr
 - mcg/min
 - units/hr
- Based on patient body weight
 - mg/kg/hr
 - mg/kg/min
 - mcg/kg/hr
 - mcg/kg/min
 - units/kg/hr

Note: The available programming functions depend on the configuration selected by your care site.

How Doses are Calculated

After the dose is entered, the pump calculates and displays the rate when the concentration has been entered or calculated. Similarly, after the rate is entered, the pump calculates and displays the dose when the concentration has been entered or calculated.

How Concentration is Determined

Concentration is a required infusion parameter. Concentration is determined by dividing the drug amount into the diluent volume. If you know the concentration, you can enter it directly into the pump. If concentration is the first parameter you enter, the Drug Amount and Diluent Volume fields are cleared.

Changing a Parameter After All Parameters Have Been Entered

If all parameters have been entered and calculated and one of the parameters is changed, the program automatically performs one or more of the following:

- If the actual Dose is changed, the Rate will be automatically recalculated, or vice versa.
- If the Drug Amount or Diluent Volume is changed, the Concentration will be recalculated.
- If the Concentration is changed, both the Drug Amount and Diluent Volume will be cleared.
- If a parameter that could indirectly affect the Dose or Rate (such as patient weight) is changed, the Rate will change but the Dose will remain constant.

Changing Units of Measure

Units of measure can be changed for the Drug Amount and Concentration values. Whenever a unit of measure is changed, the program automatically clears the program values of any parameters associated with the changed units.

Programming a Dose Independent of Patient Parameters

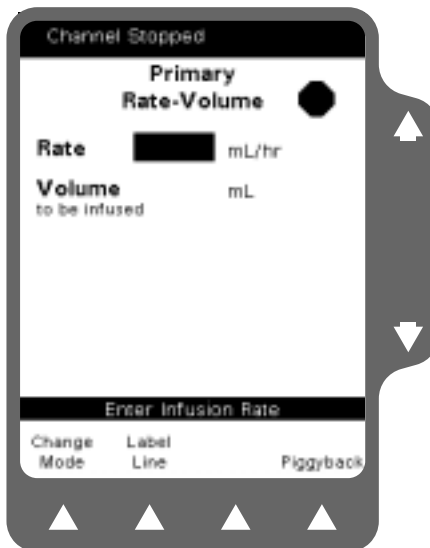

Figure 5-5 Primary Programming Screen

1. If the pump is running, press the **STOP** key to stop the pump. Press the **Primary** soft key to access the Primary Programming screen (Figure 5-5).
2. From the Programming screen, press the **Change Mode** soft key (Figure 5-5) to display the available modes (Figure 5-6).

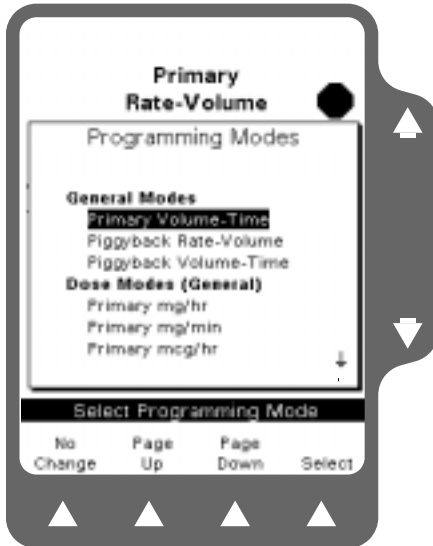

Figure 5-6 Programming Modes

3. Use the $\uparrow\downarrow$ and/or **Page Up, Page Down** soft keys to highlight the appropriate dose formula selection, if configured. Some or all of the following formulas may be available depending on your care site's settings:
 - mg/hr
 - mg/min
 - mcg/hr
 - mcg/min
 - units/hr
4. Press the **Select** soft key to display the Dose Programming screen (Figure 5-7).

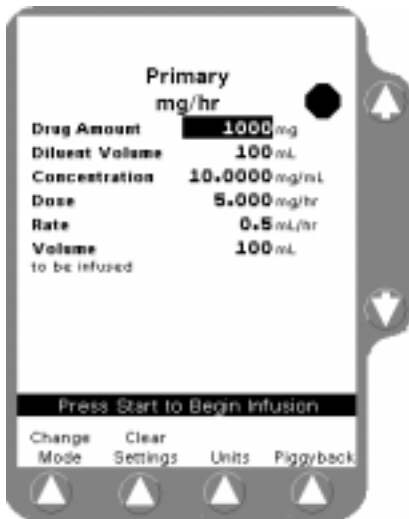

Figure 5-7 Clear Old Settings

Note: Any dose parameters retained in program memory are displayed. To clear the parameters, press the **Clear Settings** soft key (Figure 5-7).

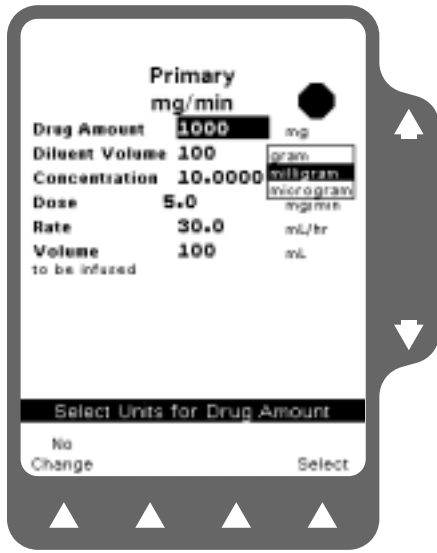

Figure 5-8 Units Change List

5. Check the measuring units displayed for the Drug Amount. If you want the amount measured in units other than the one displayed:
 - a. Press the **Units** soft key to display the Units Change list (Figure 5-8).
 - b. Use the $\uparrow\downarrow$ keys to highlight the desired measuring unit.
 - c. Press the **Select** soft key to change to the highlighted measuring unit.

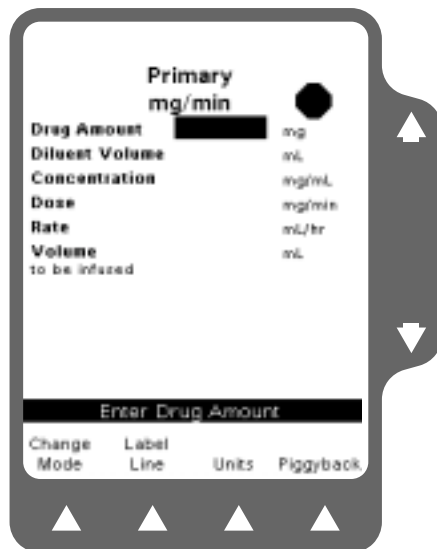

Figure 5-9 Enter Drug Amount

6. Enter the desired Drug Amount using the numeric keypad (Figure 5-9) and use the \downarrow key to highlight the Diluent Volume field.

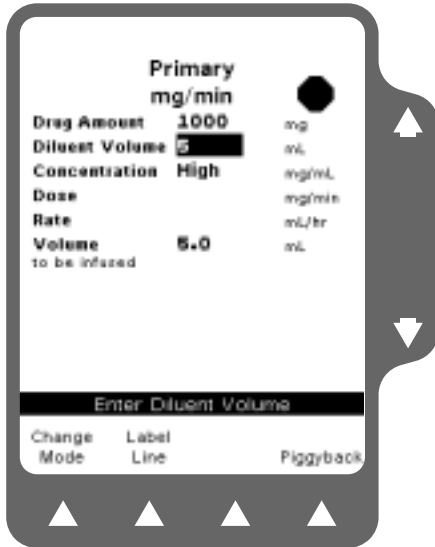

Figure 5-10 Value High Prompt

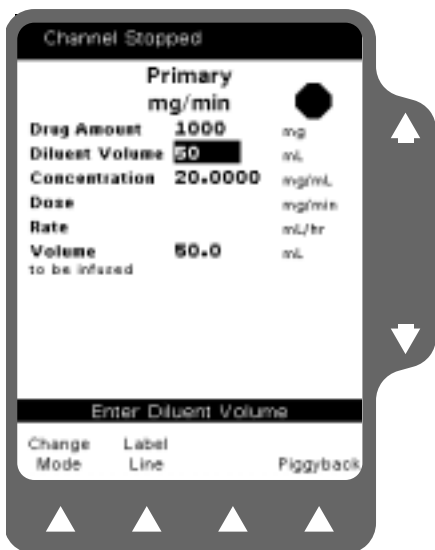

Figure 5-11 Value "HIGH" Relieved

- Enter the desired Diluent Volume (Figure 5-10).

Note: If you know the concentration value, enter it first. This eliminates the need to enter the Drug Amount and Diluent Volume parameters.

Note: The pump calculates the concentration as you enter diluent volume. In Figure 5-10, the concentration is too high because the pump is calculating as the numbers are being entered.

This HIGH condition is cleared after the rest of the digits are entered and the pump recalculates the concentration (Figure 5-11).

- Press the \downarrow key twice to highlight the DOSE field.
- Enter the desired dose using the numeric keypad (Figure 5-12).

Note: If desired, you can bypass the DOSE field using the \downarrow key and enter the Rate value first. The pump will then calculate the Dose.

The **Confirm Settings** soft key is displayed when the calculated value is in range (Figure 5-12).

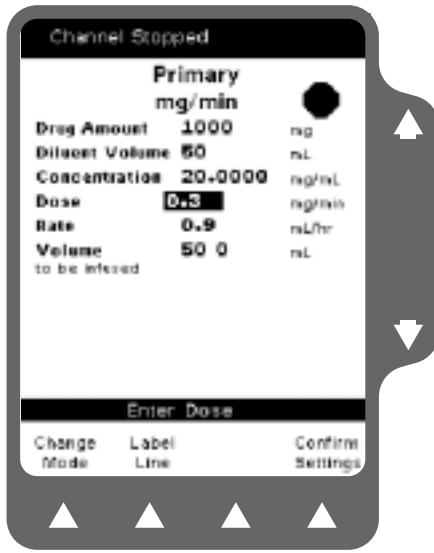

Figure 5-12 Enter the Dose

10. Use the ↓ key to highlight the Volume to be Infused field (Figure 5-13).

Note: The Volume to be Infused field defaults to the Diluent Volume. The Volume to be Infused may be less than the Diluent Volume, but cannot be greater than the Diluent Volume.

11. If appropriate, change the Volume to be Infused value.
12. For any of the dose programming functions, an optional label may also be selected. See “Label Library,” 5-2 for details.

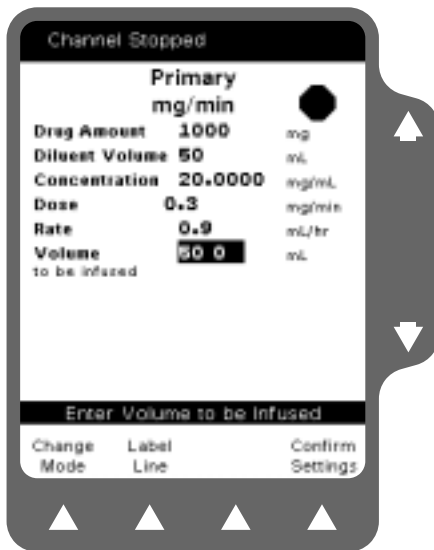

Figure 5-13 Enter Volume to be Infused

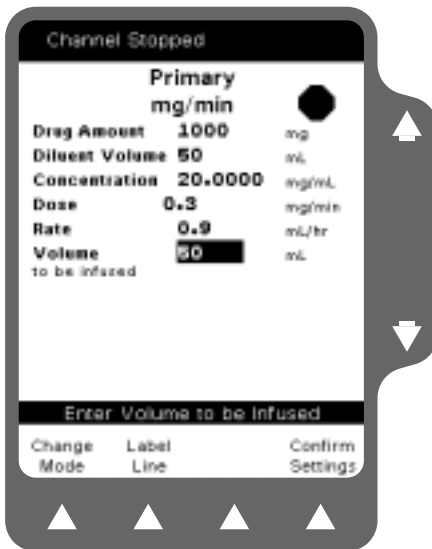

Figure 5-14 Confirm Settings

13. Verify that the displayed values are appropriate and press the **Confirm Settings** soft key (Figure 5-14).

Note: The **Confirm Settings** soft key is displayed as soon as valid Rate and Dose values are entered or calculated. The key can be pressed at any time before starting the infusion.

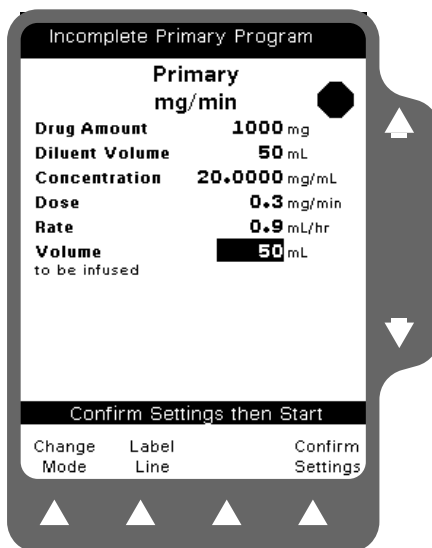

Figure 5-15 Confirm Settings Prompt

Note: If the **START** key is pressed before pressing the **Confirm Settings** soft key to verify the parameters, an Incomplete Primary Program alarm occurs and a message is displayed on the prompt line (Figure 5-15).

14. Press the **START** key to begin the infusion. The Main Display screen, showing the rate and the dose, is displayed (Figure 5-16).



Figure 5-16 Main Display

Programming a Dose Based on Patient Weight

1. If the pump is running, press the **STOP** key to stop the pump. Press the **Primary** soft key to access the Primary Programming screen (Figure 5-17).
2. Press the **Change Mode** soft key. The Programming Modes screen is displayed (Figure 5-18).

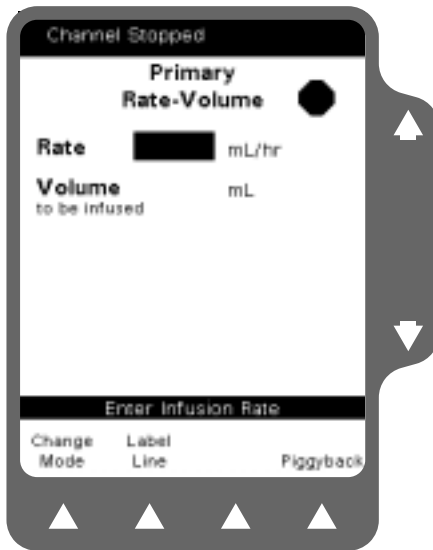

Figure 5-17 Primary Programming Screen

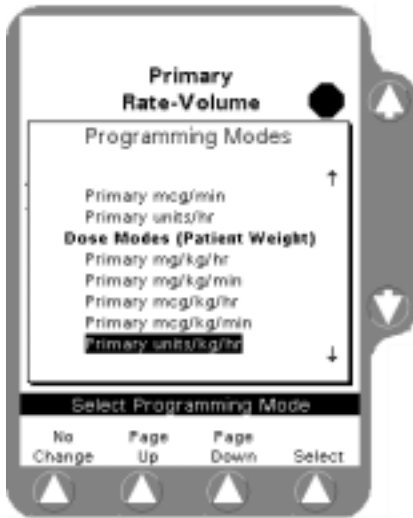

Figure 5-18 Programming Modes

3. Use the $\uparrow\downarrow$ and/or **Page Up, Page Down** soft keys to highlight the appropriate dose formula selection. Some or all of the following formulas may be available depending on your care site's configuration:

- mg/kg/hr
- mg/kg/min
- mcg/kg/hr
- mcg/kg/min
- units/kg/hr

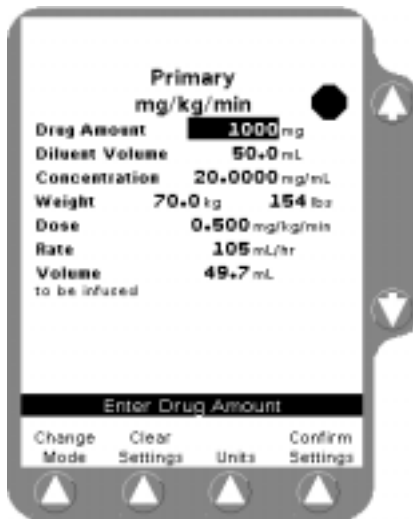

Figure 5-19 Clear Stored Settings

4. Press the **Select** soft key to display the Dose Programming screen (Figure 5-19), which allows you to enter patient weight.

Any previous dose parameters stored in memory are displayed. To clear the parameters, press the **Clear Settings** soft key.

5. Program each field as described in “Programming a Dose Independent of Patient Parameters,” 5-5.

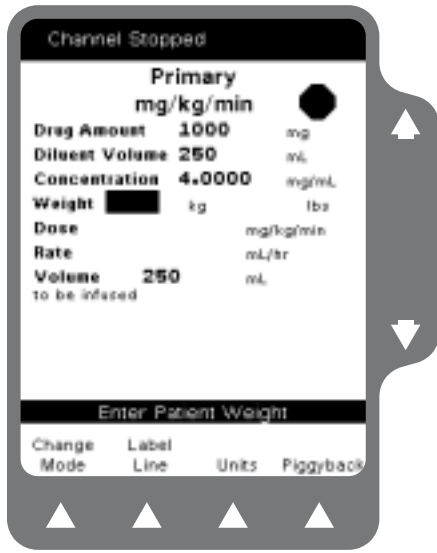

Figure 5-20 Enter Weight

- Highlight the Weight field and enter the patient’s weight using the numeric keypad (Figure 5-20).

The value can be entered in kilograms, pounds, grams, or ounces. To change the weight units, press the **Units** soft key to display the weight units list, highlight the desired weight unit, then press the **Select** soft key.

Note: The pump accepts patient weights within the range 0.2 to 600 kg (0.44 to 1322 lb).

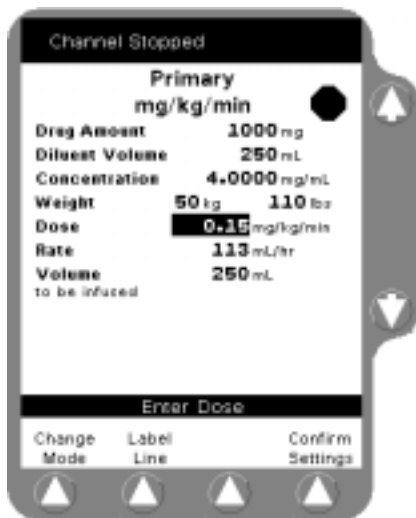

Figure 5-21 Confirm Settings

- After completing all required entries, verify that all displayed values are appropriate and press the **Confirm Settings** soft key (Figure 5-21).
- Press the **START** key to begin the infusion.

Discontinuing a Dose Program

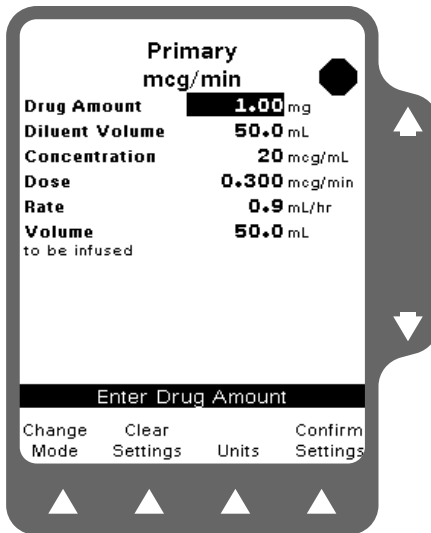

Figure 5-22 Clear Settings

1. Press the **STOP** key on the pump module.
2. Select the dose program to be discontinued by pressing either the **Primary** or **Piggyback** soft key.
3. If new values for the dose program are to be entered, press the **Clear Settings** soft key and enter new values using the procedure described earlier (Figure 5-22).

Note: If the **Clear Settings** soft key is pressed inadvertently, press the **Restore Settings** soft key to restore the programmed values.

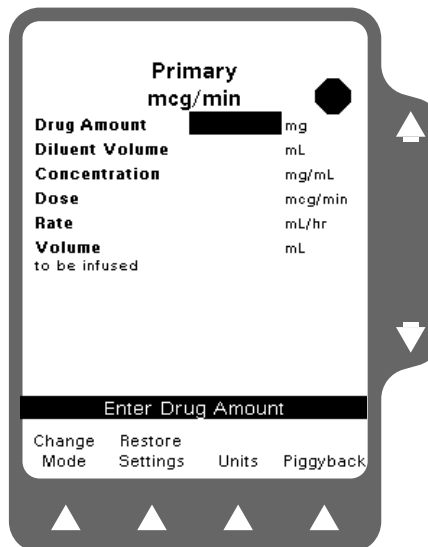

Figure 5-23 Restore Settings

4. To use other programming functions, press the **Change Mode** soft key (Figure 5-23).

Using the Optional Volume-Time Programming Function

Overview

This optional feature lets you program the pump by entering the Volume to be Infused and Time Duration parameters. The pump then calculates and displays the flow rate.

This feature is available in Primary and Piggyback modes. Piggyback infusions can be programmed in Volume-Time without stopping the primary infusion.

Using Volume-Time Programming

1. Press the appropriate programming soft key (**Primary** or **Piggyback**).
2. From the Programming screen, press the **Change Mode** soft key.
3. From the Change Mode screen (Figure 5-24), highlight the Primary Volume-Time or Piggyback Volume-Time, then press the **Select** soft key.



Figure 5-24 Change Mode Screen

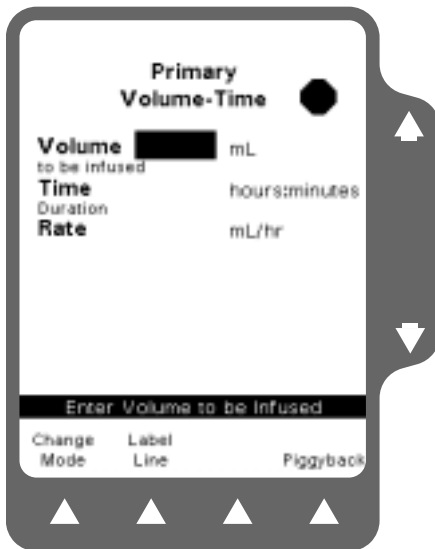

Figure 5-25 Volume-Time Programming Screen

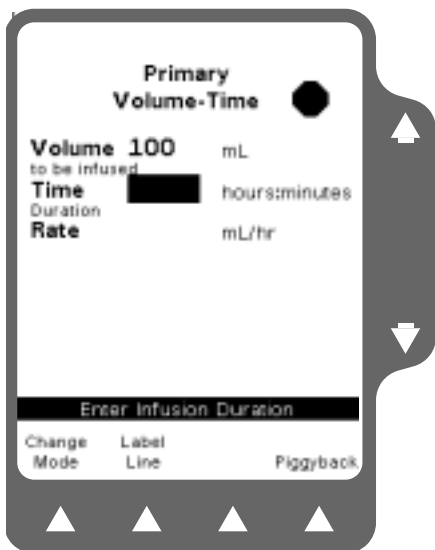

Figure 5-26 Enter Time Duration

The Volume-Time Programming screen is displayed (Figure 5-25).

4. Enter the Volume to be infused using the keypad.

5. Highlight Time Duration using the $\uparrow\downarrow$ keys. Use the key pad to enter the time period for the infusion in hours and minutes. The pump automatically calculates the flow rate (Figure 5-26).

Note: You must enter a time duration less than or equal to 99:59. If you enter a time greater than 99:59, **:*** is displayed.

Note: Depending on the time duration you enter, the pump may round off the calculated rate. If this occurs, the pump then calculates the time duration based on the rounded rate. When the **Confirm Settings** soft key is pressed, the calculated time is displayed as Time Remaining instead of the time duration you entered.

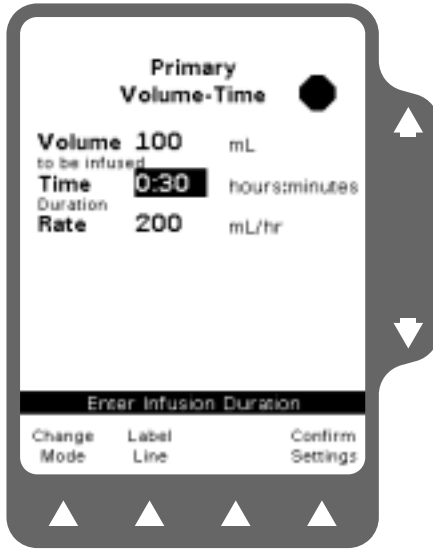

Figure 5-27 Confirm Settings

6. Verify that the displayed values are appropriate.

Note: After the time duration is programmed, you can change the Volume to be Infused or Rate fields. The pump then calculates the new time duration automatically.

Note: An optional label may also be selected. See “Label Library,” 5-2 for details.

7. Press the **Confirm Settings** soft key, then press the **START** key to begin the infusion (Figure 5-27).

Using the Optional Prime Function

Overview

The optional Prime function can be used to assist clinicians in preparing a primary administration set for infusion. This is especially useful for administration sets with microbore tubing that are difficult to manually prime using gravity.

Note: The pump will only operate in this mode while the **Prime** soft key is being pressed.

Priming the Administration Set

1. Load the administration set as described in “Loading the Administration Set,” 3-9.
2. Press the **Primary** soft key to access the Programming screen.
3. From the Programming screen, press the **Change Mode** soft key.

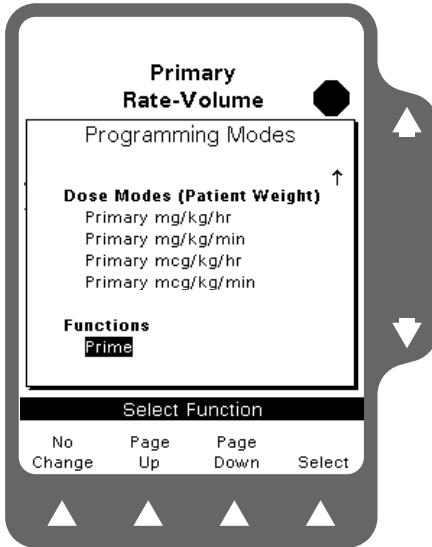

Figure 5-28 Programming Modes Menu

- Use the $\uparrow\downarrow$ keys to highlight Prime (under Functions), then press the **Select** soft key (Figure 5-28).

The PRIME WARNING Pop-up (Figure 5-29) is displayed.

Note: The administration set's drip chamber should be at least one third full prior to using the prime function to ensure that fluid will enter the administration set.

Note: Prime cannot be selected if an Air alarm is active.

! WARNING !

DO NOT CONNECT THE ADMINISTRATION SET TO THE PATIENT WHEN PRIMING.

- Press and hold the **Prime** soft key until all the air is expelled from the administration set. The PRIME ACTIVE pop-up (Figure 5-30) is displayed while you press the **Prime** soft key.



Figure 5-29 Ready to Prime



Figure 5-30 Prime Active

- When priming has been completed, press the **Done** soft key to exit the priming function and return to the primary infusion program (Figure 5-30).

Note: Priming volume is limited to 30 mLs.

Standby Mode

Standby Overview

The Standby mode allows you to place the pump module in Standby while the rest of the pump remains on. If you want to pre-program the pump without starting the infusion, or leave the pump powered on without a Channel Stopped alert, you should use the Standby mode. The pump can then remain on and the Channel Stopped alert will not occur. Standby is available for primary and piggyback infusion programs.

The **Open** key is not available when the pump is in Standby.

To exit Standby, press the **Primary** soft key, the **Rate** key, or the **Vol** key. The pump reverts to the programming mode in effect when the pump was placed into Standby.

Program Parameter Retention

The retention period for infusion parameters programmed into the pump is dependent on whether or not the pump remains powered on.

- If the pump remains powered on or in Standby, program information is retained indefinitely.
- If the pump is powered off, program information is retained for 5 hours.

Enabling Standby

1. To place the pump into Standby mode, from the Programming screen, press the **Change Mode** soft key. The Programming Modes menu is displayed (Figure 5-31).
2. From the Programming Modes screen, use the $\uparrow\downarrow$ keys to select Standby, then press the **Select** soft key.

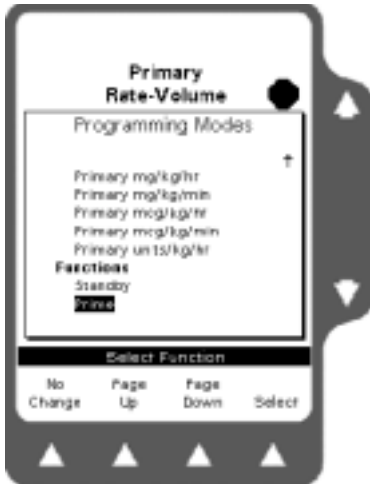

Figure 5-31 Programming Modes Menu



Figure 5-32 Standby Pop-Up

3. The Standby pop-up (Figure 5-32) is displayed.
4. Press the \uparrow key next to the YES shown on the pop-up to place the pump into Standby mode.

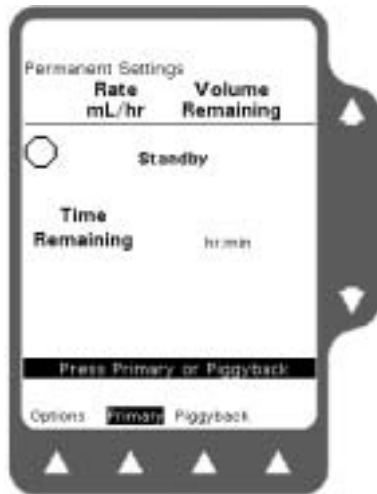

Figure 5-33 Standby Main Display

The display changes to the Main Display and shows Standby where the program status information is normally displayed (Figure 5-33).

Preprogramming the Pump for Future Use

1. With the pump stopped, access the Programming screen.
2. Program the desired infusion information as described in Chapter 3.
3. Press the **Change Mode** soft key. The Programming Modes menu is displayed (Figure 5-18).
4. Move the highlight to **Standby** and press the **Select** soft key. The Standby pop-up window is displayed (Figure 5-32).
5. Press the \hat{u} key next to the YES shown on the pop-up to place the pump into Standby mode. The programmed infusion information is retained.
6. When you wish to start the infusion, take the pump out of Standby mode as described below and start the infusion according to the instructions in Chapter 3.

Exiting Standby Mode

To exit Standby mode, press the **Primary** soft key, the **Rate** key, or the **Vol** key from the Main Display. The pump exits Standby and reverts to the programming mode in effect when the pump was placed into Standby.

Using the Optional Accessories

! WARNING !

This pump should be used only with Baxter accessories specified in “Using the Optional Accessories,” 5-22. There are risks associated with using anything other than the recommended accessories with this pump.

Nurse Call

Note: Ensure that the connector locking screws are tightened before use.

The optional Nurse Call feature allows the pump to be connected to a care site’s nurse call system. Authorized service personnel must first construct a cable equipped with a 9-pin D connector as described in the *Colleague Global Service Manual*. The cable’s 9-pin D connector is connected to the Communications Port on the rear of the pump (Figure 2-4) and the other end of the cable is connected to the nurse call system. The nurse call cable can be disconnected at any time.

Caution

Use only accessory equipment complying with the device’s safety requirements; failure to do so may lead to reduced safety levels of the resulting system. Consideration relating to accessory choice shall also include:

- use of the accessory in the patient vicinity
- evidence the safety certification of the accessory has been performed in accordance with the appropriate UL2601-1 or IEC 60601-1 and/or IEC 601-1-1 harmonized national standard.

Syringe Adapter

The Syringe Adapter (product code: 2D0300) and syringe adapter administration set allow the pump to pump fluid from a syringe. Follow the directions provided with the Syringe Adapter and syringe adapter administration set.

Configuration Transfer Cable

Configuration data can be copied from one Colleague pump to another using a Configuration Transfer cable (product code 2M8155).

Caution

Use only accessory equipment complying with the device’s safety requirements; failure to do so may lead to reduced safety levels of the resulting system. Consideration relating to accessory choice shall also include:

- use of the accessory in the patient vicinity
- evidence the safety certification of the accessory has been performed in accordance with the appropriate UL2601-1 or IEC 60601-1 and/or IEC 601-1-1 harmonized national standard.

The connector is attached to the Communications Port located on the rear of the pump (Figure 2-4). Configuration data transfers must be performed by an authorized healthcare professional. See the *Colleague Global Service Manual* for detailed instructions and precautions for using this accessory.

Event History Download Kit

For pumps with UIM master software versions from 3.04 to 5.0X, event history can be downloaded from the pump to a PC using the Colleague DL Event History Download Kit (product code 2M8317, U.S. only).

Personality Feature Sets

Overview

To meet our customers' needs, Baxter designed the Colleague Pump to be highly adaptable to each care setting. Throughout this manual, references are made to specific programming functions described as configurable options.

The Pump Personality feature enables authorized personnel to create up to eight different custom Personalities. Each Personality can be programmed to contain infusion settings specific to a particular application. An additional feature set, called Permanent Settings, cannot be changed but its settings can be copied to another feature set.

Note: Factory default settings are programmed by Baxter during the pump's manufacture. See "Configurable Options," 9-1 for the default settings.

Note: The desired Personality can only be selected at power on.

Note: Personality feature sets should be created only by authorized personnel based upon clinical protocols. An access code is required to program Personality feature sets. See the *Colleague Global Service Manual* for more information.

Note: If Clinician Override of Downstream Occlusion Values is enabled, the settings within the current Personality feature set can be temporarily changed. When the pump is powered off, the default settings are reactivated.

Selecting a Pump Personality Feature Set



Figure 5-34 Examples of Custom Personality Feature Sets

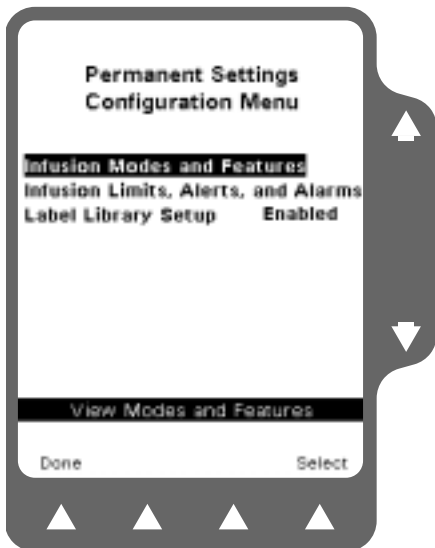

Figure 5-35 Configuration Screen Example

The current Personality feature set can only be changed during the Power On sequence. See “Powering On the Pump,” 3-6 for complete instructions.

1. Press the **Change Personality** soft key from the Power On Screen after Self Test (Figure 3-9).
2. Use the $\uparrow\downarrow$ keys to highlight the desired Personality feature set (Figure 5-34).

Note: Changing the Personality feature set also clears the volume history and the programming parameter settings such as Rate and Volume to be Infused.

To view a specific Personality feature set:

1. Use the $\uparrow\downarrow$ keys to highlight the desired Personality feature set, then press the **View Personality** soft key to view the Personality Configuration menu (Figure 5-35).
2. Use the $\uparrow\downarrow$ keys to highlight the desired configuration item. Press the **Select** soft key to view the details for the selected configuration setting.

Troubleshooting

Alert, Alarm, and Failure Messages

This chapter lists all alert and alarm messages in alphabetical order.

Active alert, alarm, and failure messages are displayed on the status line at the top of the Main Display (Figure 6-1). An abbreviated form of the message is also shown on the pump module display.

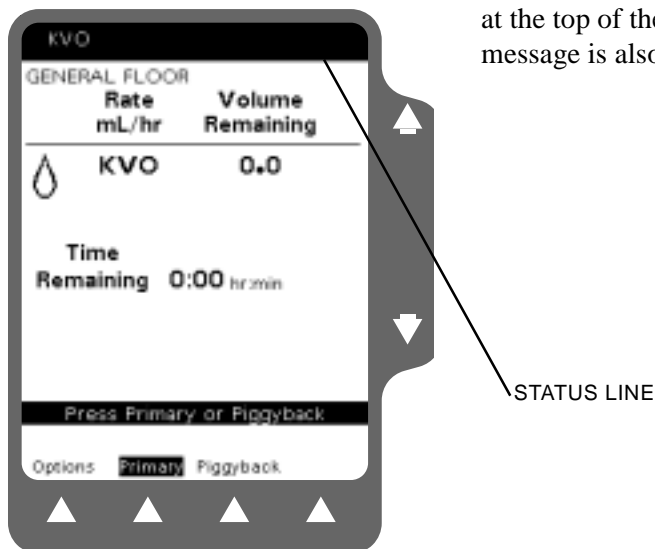

Figure 6-1 Main Display Status Line

Troubleshooting Alerts

Overview

Alerts call attention to conditions that may require user intervention without stopping the infusion. During an alert condition, the pump displays a message in the Main Display's status line and on the pump module display. In addition, the yellow ALERT LED lights and an alert tone sounds.

To silence the alert tone for two minutes, press the **Alarm Silence** key.

Note: Selected label information may alternate with an abbreviation of the alert message shown in the status line on the pump module display. This alternating message condition is shown in the text by using a “ / ” mark between the pump module message and the label.

For example:

KVO/label indicates that the KVO alert message alternates with the selected label on the pump module display.

Troubleshooting Advance Air Alerts

Status Line Message: Advance Air

Pump module Display Message: ADV AIR

Indication: The pump is in Advance Air mode. The Advancing Air screen is displayed (Figure 6-2).

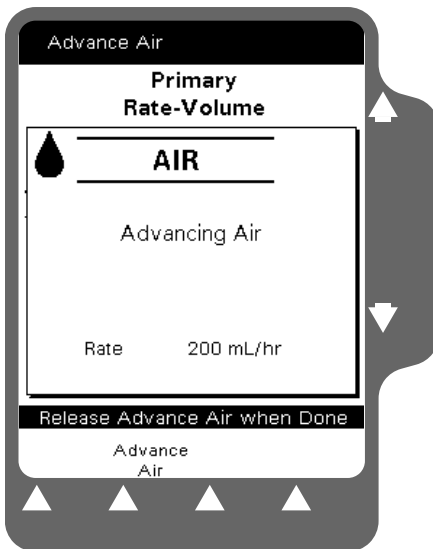

Figure 6-2 Advancing Air

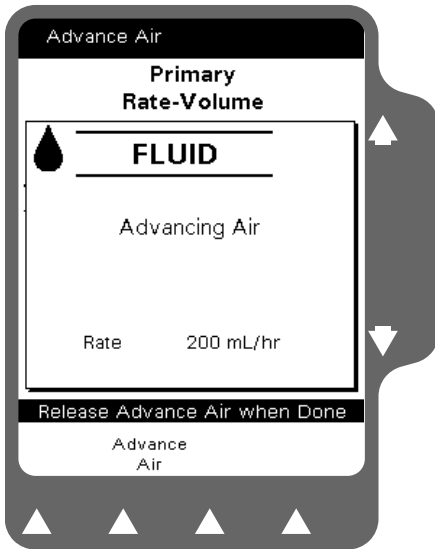

Figure 6-3 Fluid Detected

Recommended Action:

1. Release the **Advance Air** soft key when the bubble can be seen or fluid is detected (Figure 6-3).

! WARNING !

While the Colleague Pump automatically closes the keyed On/Off Clamp, always close the regulating clamp on the administration set before removing the administration set from the pump.

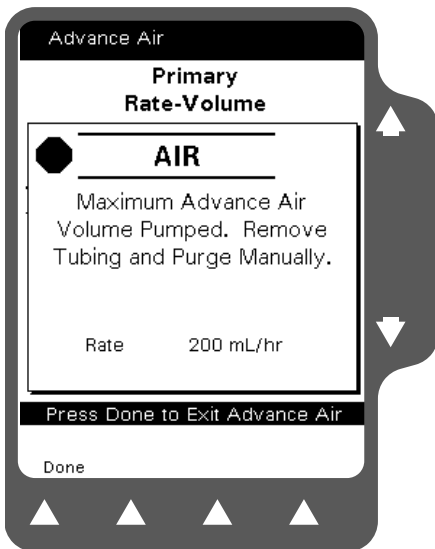

Figure 6-4 Advance Air Volume Limit

If 0.4 mL of fluid has been pumped, the Advance Air Volume Limit screen will be displayed and the **Advance Air** soft key will be disabled (Figure 6-4).

2. Follow your care site's procedures for manually removing the air bubble.

Note: When the maximum advance air volume has been pumped, the AIR alarm will not recur until the **START** key has been pressed.

Table 6-1 shows you how to troubleshoot all other pump alert messages. The left column of the table shows the alert messages displayed on the Main Display and on the pump module display. The middle column describes the cause of the alert, and the right column recommends the action to take to correct the alert.

Troubleshooting Other Alerts

Table 6-1 Troubleshooting Pump Alert Messages

Alert Message	Cause	Recommended Action
Battery Low BATT LOW	The charge remaining in the battery has approximately 30 minutes of infusion time left. This alert occurs before the Battery Depleted alarm.	Plug the pump into an AC power source.
Changing Piggyback Program (xx.x or xxx) mL/hr (where xx.x or xxx = infusion rate)	The piggyback rate is being changed during a piggyback infusion.	Finish the piggyback data entry and press START key.
Changing Primary Program (xx.x or xxx) mL/hr (where xx.x or xxx = infusion rate)	A primary rate or dose is being changed during an infusion.	Finish the primary data entry and press START key.
Channel Stopped STOPPED	The pump is powered on and the infusion is not running.	Complete remaining programming steps and press the START key or power off the pump.
Lithium Battery Low BATT LOW	The charge remaining in the lithium battery is low.	Remove the pump from service and have authorized service personnel replace the lithium battery.
KVO KVO=x.x/label (where x.x = infusion rate)	The Volume to be Infused has decremented to zero and the pump is infusing at the KVO rate (or the programmed rate, whichever is lower).	Prepare a new infusion or power off the pump.
Piggyback Callback at HH:MM CALLBACK	The piggyback infusion has been completed and the pump has switched over to the primary rate or KVO. The callback feature was enabled.	Press the Alarm Silence key or any programming key if appropriate.
Priming PRIMING	The Prime soft key is being pressed.	Release the Prime soft key after the set is primed.
Programming Piggyback (xx.x or xxx) mL/hr (where xx.x or xxx = primary infusion rate)	Programming of the piggyback function is occurring during the primary infusion. The alert is intended as a reminder to complete the piggyback program and start the piggyback infusion, if appropriate.	Complete the piggyback program and press the START key.

Troubleshooting Alarms

Overview

Alarm conditions automatically stop the infusion and require immediate attention before the infusion can be restarted. An alarm condition displays a message in the Main Display's status line and on the pump module display. In addition, the red ALARM LED flashes and the alarm tone sounds.

6

An alarm will override an existing alert condition.

To silence the alarm tone for two minutes, press the **Alarm Silence** key.

Note: Selected label information may alternate with an abbreviation of the alarm message shown in the status line on the pump module display. This alternating message condition is shown in the text by using a "/" mark between the pump module message and the label.

For example:

AIR/label indicates that the AIR alarm message alternates with the selected label on the pump module display.

Troubleshooting Air Detected Alarms

Status Line Message: Air Detected

Pump module Display Message: AIR/label

Indication: The pump has detected an air bubble based on a configured setting.

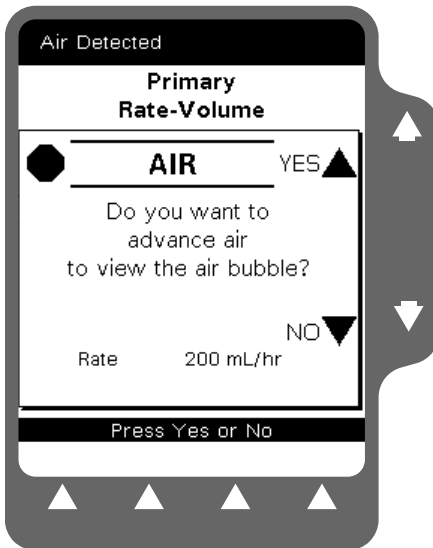

Figure 6-5 Advance Air Pop-Up

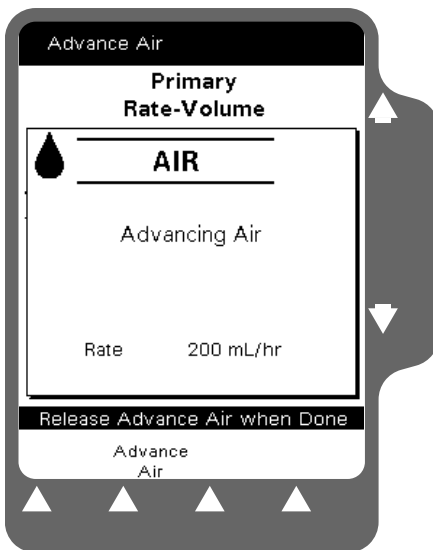

Figure 6-6 Advancing Air

Recommended Action:

1. When an air alarm occurs, the Advance Air pop-up window is displayed (Figure 6-5). Press the \uparrow key next to the YES label for pump-assisted viewing of the detected air.

Note: If the Volume to be Infused is less than 0.4 mL when air is detected, the pop-up also displays the message Switchover may occur during Air Advance.

If pump assisted viewing of the detected air is not desired, press the \downarrow key (NO) to manually purge the air. Remove the administration set as described in “Unloading the Administration Set,” 3-10 and remove the air from the tubing in accordance with the recommended practices of your care site. When manual purge has been completed, go to Step 4 of these instructions.

Note: Pressing the **No** key and then unloading the set to manually purge the air causes the pump to exit the Advance Air screen.

2. Press and hold the **Advance Air** soft key. The pump pumps at the currently programmed rate until you release the **Advance Air** soft key (Figure 6-6).

Note: An Advance Air alert will occur while using the advance air mode.

When the pump detects fluid, a fluid detected icon is displayed (Figure 6-7).

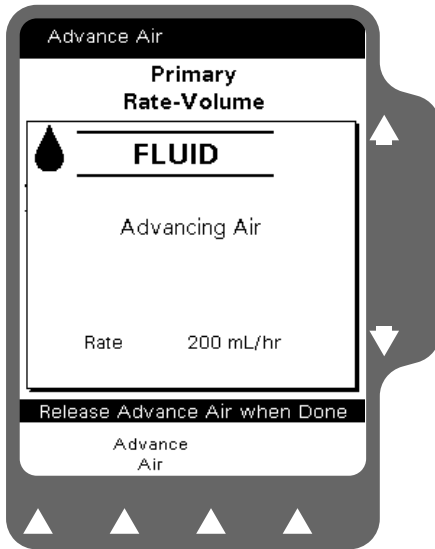

Figure 6-7 Fluid Detected

3. When the fluid detected icon is displayed, the alarm condition is reset. Visually inspect the air bubble and follow your care site's procedures for manually removing the air bubble.
4. When the air has been removed, the infusion may be restarted. Press the **Primary** or **Piggyback** soft key to access the appropriate programming screen and then press the **START** key.

6

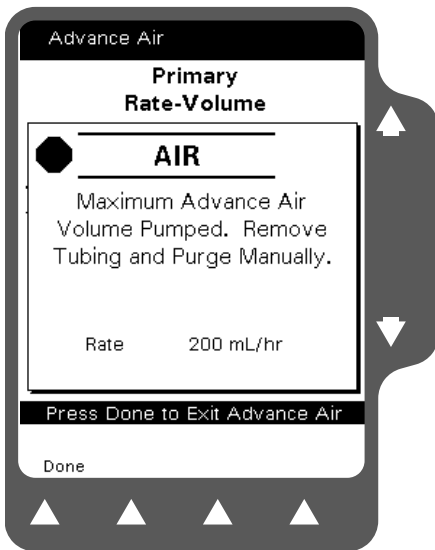

Figure 6-8 Maximum Volume Pumped

Note: If 0.4 mL of fluid has been pumped, the Advance Air Limit screen is displayed (Figure 6-8).

! WARNING !

While the Colleague Pump automatically closes the keyed On/Off Clamp, always close the regulating clamp on the administration set before removing the administration set from the pump.

Troubleshooting Other Alarms

Table 6-2 shows you how to troubleshoot all other pump alarms. The left column of the table shows the alarm messages displayed on the Main Display and on the pump module display. The middle column describes the cause of the alarm, and the right column recommends the action to take to correct the alarm.

Table 6-2 Troubleshooting Alarm Messages

Alarm Message	Indication	Recommended Action
Battery Depleted BATTERY	The pump has approximately 3 minutes of power left before the battery is depleted. After 3 minutes in this alarm, the pump will turn off all displays to conserve power. The backup beeper will continue to sound.	To stop the alarm, power off the pump by pressing the ON/OFF CHARGE key. Plug into an AC power source immediately. Power on the pump. To resume an infusion, press the Primary or Piggyback soft key, then press START .
Close Regulating Clamp PATIENT---->>>>	The Open key was pressed when a set was loaded.	<ul style="list-style-type: none"> • Close the regulating clamp and remove the keyed On/Off Clamp from the slot. • Reload the set, if desired.
Downstream Occlusion DWN OCCL/label	The pump has detected a closed distal clamp, stopcock, clogged filter or other occlusion downstream.	<ul style="list-style-type: none"> • Clear the problem causing the occlusion. • Restart the infusion. Press the Primary or Piggyback soft key to access the appropriate programming screen and then press the START key. <p>Note: When the pump is configured with the Auto Restart feature on, the pump can automatically restart if the occlusion is removed within one minute after detection. If any pump key is pressed during a Downstream Occlusion alarm, Auto Restart will be disabled.</p>
Incomplete Piggyback Program Incomplete Primary Program STOPPED	The START key was pressed prior to entering or confirming programming information.	Enter the missing parameter value(s) and press the Confirm Settings soft key, if required, followed by the START key.
Piggyback Out of Range Primary Out of Range STOPPED	A programming value outside the programmable range allowed has been entered. This alarm occurs as soon as the Confirm Settings soft key or START key is pressed.	<ul style="list-style-type: none"> • Verify the appropriate values have been entered. • Press the Confirm Settings soft key, if required, and the START key to begin the infusion. • If alarm recurs, the value range available in the current Personality setting may not be broad enough to accommodate your entries. Check the current Personality feature set configuration.

Table 6-2 Troubleshooting Alarm Messages — continued

Alarm Message	Indication	Recommended Action
Reset Manual Tube Release RESET	The Manual Tube Release was activated.	Remove the administration set and reset the Manual Tube Release. See “Using the Manual Tube Release,” 3-11 for details.
Temperature Too High TEMP HGH/label	Operating or administration set temperature is outside the design limits	Move the pump, administration set, and solution to a suitable temperature environment.
Temperature Too Low TEMP LOW/label	Operating or administration set temperature is outside the design limits.	<ul style="list-style-type: none"> • Move the pump, administration set, and solution to a suitable temperature environment. • Allow cold solutions or sets to warm to the operating temperatures before use.
Tube Loading in Progress LOADING/label	The administration set was not fully loaded in the tubing channel when the START key was pressed.	Wait for the loading action to complete, then press the START key.
Tube Misloaded CHK TUBE	<ul style="list-style-type: none"> • The administration set is improperly loaded. • The administration set was not fully removed from the tubing channel. • A hardware problem may have occurred. 	<ul style="list-style-type: none"> • Close the regulating clamp on the administration set and remove the administration set. See “Loading the Administration Set,” 3-9. • If alarm occurs again, a hardware problem may exist. Take the pump out of service and have it inspected by a Baxter authorized service person.
Tube Not Loaded NO TUBE	The administration set was not loaded prior to pressing the START key.	<ul style="list-style-type: none"> • Press the Open key to reset the alarm. • Load the administration set, then press the START key.
Upstream Occlusion UPOCCL/label	A closed clamp, obstruction, or kink in the administration set is preventing fluid flow between the source container and the pump.	<ul style="list-style-type: none"> • Ensure the source container has been adequately pierced by the spike on the administration set. • Inspect the administration set above the pump for closed clamps or kinks. • Ensure that Buretrol administration sets or source containers are vented. • Restart the infusion. Press the Primary or Piggyback soft key to access the appropriate programming screen and then press the START key.

Troubleshooting Failures

Overview

A failure overrides all alerts and alarms and indicates a potential problem was detected with the pump. A failure automatically stops any infusion. When a failure is detected, a Failure XXX:YY...Y message (where XXX = failure code and YY...Y = additional diagnostic data) is displayed in the status line of the Main Display. FAILURE is displayed on the pump module, the ALARM LED continuously lights, and a failure tone sounds. The pump should be taken out of service immediately and inspected by authorized service personnel.

Channel Failure mode allows retrieval of volume and infusion history from the pump in the event of a pump module failure.

Acknowledging Channel Failures



1. If a channel failure (Figure 6-9) occurs, access the programming screen from the Main Display if necessary by pressing the **Primary** or **Piggyback** soft key.

Figure 6-9 Channel Failure Status Line Display



Figure 6-10 Channel Failure Pop-up Message

2. The pop-up message shown in Figure 6-10 is displayed. Remove the administration set from the tubing channel and press the **Done** soft key to acknowledge the pop-up message.



Figure 6-11 Channel Failure Display

3. The Main Display shows that the pump is out of service (Figure 6-11). The pump cannot be used to deliver infusions, but you can still use the **Volume History** key to retrieve history information.
4. Remove the pump from service and have it inspected by qualified service personnel as soon as possible.

Note: If the pump is running on battery power and a channel failure occurs, the failure message may not be displayed on the pump module display. The failure will be displayed on the Main Display, the Alarm LED will light, and the audible tone will occur.

Unloading the Administration Set after Channel Failure

! WARNING !

While the Colleague Pump automatically closes the keyed On/Off Clamp, always close the regulating clamp on the administration set before removing the administration set from the pump.

If the pump has failed with the tube loading mechanism in the “open” position:

1. Close the regulating clamp and remove the set.
2. Continue with step 4 below.

OR

If the pump has failed with the tube loading mechanism in the “closed” position,

1. Close the regulating clamp.
2. Power the pump off and back on (see “Powering On the Pump,” 3-6).
3. Press the **Open** key. If the mechanism opens, remove the set.

If the **Open** key fails, close the regulating clamp and use the Manual Tube Release to remove the set (see “Using the Manual Tube Release,” 3-11).

4. Reset the Manual Tube Release, then power off the pump (see “Powering Off the Pump,” 3-8).

Resetting Manual Tube Release after Channel Failure

If you attempt to power off the pump without first resetting the MTR in this situation, the Reset Manual Tube Release pop-up is displayed.

Reset the MTR as described on page 3-12, then power off the pump.

Note: If you use the Manual Tube Release following a channel failure to remove the administration set, the pump cannot be powered off until the Manual Tube Release has been reset. A Reset Manual Tube Release pop-up message will be displayed.

Note: If three unsuccessful attempts are made to reset the Manual Tube Release, a channel failure will occur and the pump will be unavailable for use until the Manual Tube Release is reset and the pump is powered off and back on.

Maintenance and Storage

Cleaning Overview

The exterior of the pump may be cleaned with a soft cloth, sparingly dampened with any of the cleaners listed below. **Do not spray cleaners directly into the tubing channel or the area where the power cord enters the pump. Do not use hard instruments for cleaning.** Follow the manufacturer's dilution instructions for concentrated cleaners. Always clean/disinfect the pump after each use. For a pump that has been in an Isolation Area, select those agents from the list below that both clean and disinfect.

The pump's design safeguards against fluid spillage into the pump module. Contact your Baxter Service Center for assistance immediately if fluid enters the tubing channel. The tubing channel should be cleaned as soon as possible by authorized service personnel to minimize potential difficulties caused by fluid pooling and drying on the mechanism. See "Authorized Service Centers," 10-2.

7

Recommended Cleaners

The following cleaners were tested on the pump:

- Soapy water
- A solution of 10% bleach and water
- Isopropyl alcohol up to 95%
- **LpH**, by Vestal Labs
- **Septisol**, by Vestal Labs
- **Cidex 7**, by Surgikos
- **Super Edisonite**, by Brand GmbH
- **TOR, Hi-Tor Plus**, Huntington Professional Products
- **Bafix**, Hysan Corporation

Caution

Do not clean, disinfect, or sterilize any part of the pump by autoclaving or with ethylene oxide gas. Doing so may damage the pump and void the warranty. Only external parts of the pump should be disinfected.

Caution

Do not use the following chemicals on the pump, as they will damage the front panel: acetone, acetoaldehyde, ammonia, benzene, hydroxytoluene, methylene chloride, and ozone. Do not use cleaners containing n-alkyl dimethyl ethylbenzyl ammonium chloride unless they appear in the list of recommended cleaners above.

Preventive Maintenance

The table below contains a schedule of basic maintenance tasks that should be performed on the pump. If the pump cannot be cleaned using the basic methods described earlier or components are missing or damaged, discontinue use and notify the appropriate authorized service personnel. To contact Baxter for authorized service or repair, see “Service Information,” 10-2.

Check	Action
Perform as required but recommended after every use.	
Housings	Clean housing and front panel as recommended in the cleaning instructions in this section. Check for cracks and large dents.
Labels	Clean as recommended in the cleaning instructions. Check for scratches, cuts or obliterated words.
Power cord	Verify that the power cord is undamaged over the entire length of the cord and the moulded plug.
Feet	Verify that the feet are free of cuts or deterioration and that they are securely fastened.
Rear housing	Verify that there are no loose or missing parts and that connectors and accessories are undamaged.
Contrast and Volume controls	Verify that both controls are undamaged and rotate freely.
Pole clamp knob and mechanism	Verify that knob operates freely throughout range of motion. Ensure that pads are present; check that the pump remains attached to IV pole.

Check	Action
Main Batteries	Recharge by plugging into 100-120 VAC 50/60 Hz or 220-240 VAC 50/60 Hz power outlet for at least 12 hours. Check that the plug icon is illuminated during this time.
Perform as required but recommended monthly.	
Main Batteries	Recharge by plugging into 100-120 VAC 50/60 Hz or 220-240 VAC 50/60 Hz power outlet for at least 12 hours. Check that the plug icon is illuminated during this time.
Perform as required but recommended every 12 months.	
Entire pump	Schedule operational checkout by qualified biomedical personnel or authorized service representative.

Battery Operation Overview

The pump can be battery-powered in emergency situations and while transporting patients. When battery-powered, the Battery icon is lit. To check the battery charge level, access the Battery Charge Level display via the Options Menu. See “Checking Battery Charge Level,” 4-5 for details.

Battery Charging

The batteries are charging whenever the pump is plugged into a 100-120 VAC, 50/60 Hz or 220-240 VAC 50/60 Hz outlet, regardless of whether the pump is on or off. Whenever the batteries are charging, the Plug icon is lit. The batteries should be charged at least once a month. See “Storage,” 7-4 and the *Colleague Global Service Manual* for more battery information.

In general, the more often batteries are discharged and recharged, the sooner they will need to be replaced. Notify a Baxter authorized service person for replacement. **Batteries should only be replaced by authorized service personnel.** Replacement batteries (Baxter part number 5009480001) can be obtained by calling your authorized Baxter Service Center (see “Warranty and Service Information,” 10-1).

Battery Disposal

The pump contains sealed lead acid batteries which should not be disposed of in the trash. They may be returned to your authorized Baxter Service Center marked “FOR DISPOSAL.”

Storage

It is recommended that the pump remain plugged in during storage to maintain the batteries at full charge. Do not store the pump with the **ON/OFF CHARGE** key ON and the pump unplugged. The batteries may discharge completely, permanently damaging them. If the pump is to be stored for longer than 90 days, the batteries should be removed by a Baxter authorized service person and stored in appropriate environmental conditions. See the table below for details.

	Storage Temperature					
	10°C (50° F)	20°C (68° F)	30°C (86° F)	40°C (104° F)	50°C (122° F)	57°C (135° F)
Maximum pump storage time with batteries installed	90 days ¹	90 days ¹	90 days ¹	70 days	46 days	27 days
Maximum battery storage time (batteries removed from pump)	450 days	360 days	270 days	135 days	68 days	34 days

1. Baxter recommends removing the batteries if the pump is to be stored for more than 90 days.

Storage of the pump at temperatures greater than 24°C (75°F) will hasten battery discharge which may shorten the batteries' overall operating life.

When unpackaged, ensure the pump is stored in a clean and dry (20-95% RH, non-condensing) environment to safeguard against prolonged exposure to dust and moisture. In conditions falling outside the Environmental Operating Limits (see "Technical Specifications," 8-1), Baxter recommends that the pump be repackaged in the original shipping materials.

Technical Specifications

Component	Description
Device Type	<p>U.S.: 2M8151 U.K.: 2M8151K Single Channel Shuttle Volumetric Infusion Pump</p>
Administration Sets	<p>U.S.: Standard Baxter administration sets equipped with keyed On/Off Clamps Latin America: Baxter “Green Label” C96XX administration sets equipped with keyed On/Off Clamps or Standard Baxter administration sets equipped with keyed On/Off Clamps EEC Countries: Baxter “Green Label” C96XX administration sets equipped with keyed On/Off Clamps See “Recommended Administration Sets,” 3-4.</p>
AC Power Requirements	100/120 VAC 50/60 Hz or 220-240 VAC 50/60 Hz
Leakage Current	Less than 300 μ amps earth leakage (tested per UL 2601)
External Fuses	1.6 amp Type T (time delay) 250V
Power Cord	Approximately 2.7 m (9 feet) long with integrally moulded plug
Battery Supply System	<p>7 hours operating time at 100 mL/hr (fully charged new batteries) 12 hours to recharge to 80% of capacity Internal charge system recharges batteries whenever pump is connected to an AC outlet.</p>

Component	Description																				
Range of Programmable Flow Rates	Primary Infusion <ul style="list-style-type: none"> • 0.1 to 99.9 mL/hr in 0.1 mL/hr increments • 1 to 1200 mL/hr in 1 mL/hr increments Piggyback Infusion <ul style="list-style-type: none"> • 0.1 to 99.9 mL/hr in 0.1 mL/hr increments • 1 to 500 mL/hr in 1 mL/hr increments Note: Rate limits can be configured for values less than those stated above.																				
Volume to be Infused	<ul style="list-style-type: none"> • 0.1 to 99.9 mL in 0.1 mL increments (micro) • 1 to 9999 mL in 1 mL increments (macro) Note: Volume to be infused limits can be configured for values less than those stated above.																				
Patient Weight Range (for dose modes based on patient weight)	Programmable from 0.2 to 99.9 kg in 0.1 kg increments Programmable from 100 to 600 kg in 1 kg increments (Programmable from 0.44 to 99.99 lb in 0.01 lb increments Programmable from 100 lb to 1322 lb in 1 lb increments)																				
KVO	0.1 to 5 mL/hr in 0.1 mL increments (configurable option) or programmed rate, whichever is less																				
Priming Rate	500 mL/hr Note: To be used only when not connected to patient.																				
Advance Air Rate to Advance an Air Bubble	At the same rate programmed for the current primary or piggyback infusion																				
Air Bubble Setting	The air bubble setting is a configurable option. The air sensor measures the accumulated amount of air detected over an amount of solution delivered. The amount of delivered solution depends on the programmed bubble size. The air alarm is triggered for a single air bubble greater than the set threshold or an accumulation of air greater than the threshold. The alarm threshold and accumulation volumes are given in the table below. <table border="1" data-bbox="592 1499 1138 1675" style="margin-left: auto; margin-right: auto;"> <thead> <tr> <th style="text-align: left;">Air Bubble Setting</th> <th style="text-align: left;">Accumulation Volume</th> </tr> </thead> <tbody> <tr> <td>25 microliters</td> <td>0.83 mL</td> </tr> <tr> <td>50 microliters</td> <td>1.67 mL</td> </tr> <tr> <td>100 microliters</td> <td>3.33 mL</td> </tr> <tr> <td>150 microliters</td> <td>5.00 mL</td> </tr> </tbody> </table>	Air Bubble Setting	Accumulation Volume	25 microliters	0.83 mL	50 microliters	1.67 mL	100 microliters	3.33 mL	150 microliters	5.00 mL										
Air Bubble Setting	Accumulation Volume																				
25 microliters	0.83 mL																				
50 microliters	1.67 mL																				
100 microliters	3.33 mL																				
150 microliters	5.00 mL																				
Nominal Downstream Occlusion Values for Alarm	Downstream Occlusion Alarm sensitivity is a configurable option. <table border="1" data-bbox="540 1745 1386 1953" style="margin-left: auto; margin-right: auto;"> <thead> <tr> <th colspan="4" style="text-align: center;">Rate range in mL/hr</th> </tr> <tr> <th style="text-align: center;"><21</th> <th style="text-align: center;">21-200</th> <th style="text-align: center;">>200</th> <th></th> </tr> </thead> <tbody> <tr> <td style="text-align: center;">103 mmHg (2 psig)</td> <td style="text-align: center;">206 mmHg (4 psig)</td> <td style="text-align: center;">310 mmHg (6 psig)</td> <td style="text-align: center;">Minimum</td> </tr> <tr> <td style="text-align: center;">258 mmHg (5 psig)</td> <td style="text-align: center;">413 mmHg (8 psig)</td> <td style="text-align: center;">568 mmHg (11 psig)</td> <td style="text-align: center;">Moderate</td> </tr> <tr> <td style="text-align: center;">465 mmHg (9 psig)</td> <td style="text-align: center;">620 mmHg (12 psig)</td> <td style="text-align: center;">775 mmHg (15 psig)</td> <td style="text-align: center;">Maximum</td> </tr> </tbody> </table>	Rate range in mL/hr				<21	21-200	>200		103 mmHg (2 psig)	206 mmHg (4 psig)	310 mmHg (6 psig)	Minimum	258 mmHg (5 psig)	413 mmHg (8 psig)	568 mmHg (11 psig)	Moderate	465 mmHg (9 psig)	620 mmHg (12 psig)	775 mmHg (15 psig)	Maximum
Rate range in mL/hr																					
<21	21-200	>200																			
103 mmHg (2 psig)	206 mmHg (4 psig)	310 mmHg (6 psig)	Minimum																		
258 mmHg (5 psig)	413 mmHg (8 psig)	568 mmHg (11 psig)	Moderate																		
465 mmHg (9 psig)	620 mmHg (12 psig)	775 mmHg (15 psig)	Maximum																		

Technical Specifications

Component	Description
Auto Restart	Allows the pump to automatically restart if an occlusion is relieved within approximately one minute after detection. This configuration option allows 0 to 9 restarts before manual intervention is required.
Size	Approximately 259 x 197 x 203 mm (10.2" H x 7.75" W x 8.0" D) Does not include mounting clamp knob or power cord.
Weight	Approximately 5.5 kg (12.1 lbs) including mounting clamp
Environmental Operating Limits	15°C to 38°C (59°F to 100°F), 20 to 95% Relative Humidity non-condensing, 700 – 1060 hPa Barometric Pressure
Environmental Storage and Transport Limits	-29°C to 57°C (-20°F to 135°F), 10 to 100% Relative Humidity including condensation 500 - 1060 hPa Barometric Pressure See “Storage,” 7-4 for additional information.
Accessories	U.S. only: Colleague DL Event History Download Kit (for pumps with UIM master software versions from 3.04 to 5.0X, product code 2M8317) Configuration Transfer Cable (Product code 2M8155) Syringe Adapter (Product code 2D0300)
Ground Impedance	Less than 0.2 ohms (tested per UL-2601)
Solution Container Height	Pump will operate at all programmable flow rates with a solution container height ranging from -914 to +1219 mm (-36 to +48 inches). Container height is measured from the tubing channel to the top of the fluid level in the source container.
Interfaces	Attachment to a remote nurse call system A variety of systems exist which enable alert and alarm conditions to be transmitted to a remote location via the communications port on the rear panel of the pump. See the <i>Colleague Global Service Manual</i> for additional information.

Recommended Practices

- Connections of this pump to the same patient line with other infusion systems or accessories may alter the system performance. Consult the infusion system or accessory manufacturer’s instructions for use before proceeding.

- To ensure that pump performance is maintained, annual inspections should be performed by authorized service personnel in accordance with the *Colleague Global Service Manual*.

In the U.S., annual inspections should be performed in accordance with the JCAHO (Joint Commission on Accreditation of Healthcare Organizations) procedure.

Volumetric Accuracy of the System

The Colleague Volumetric Infusion Pump, using the administration sets identified in Chapter 3, maintains a volumetric accuracy with delivery errors not exceeding $\pm 5\%$ for any one hour period over 72 hours at 100 mL/hr. At very low flow rates (0.1 mL/hr to 0.9 mL/hr), the delivery errors do not exceed $\pm 10\%$ for any one hour period or for 0.5 mLs of delivery, whichever is greater.

Note that flow fluctuations can be caused by unusual conditions or combinations of conditions that may involve, but are not limited to, the following: position of the infusion container, fluid density, positive and negative pressure and the environment. Flow fluctuations are most likely to occur when the conditions mentioned above are exacerbated or when the pump is operated in conditions outside of its normal limits. See the Component Description Table on page 8-1 for details.

The accuracy figures as stated are based upon operation at a room temperature of 22°C (72°F) with a source container height of 50.8 cm (20 inches). Note that container height is measured from the tubing channel to the top of the fluid level in the source container.

Startup Graph Description

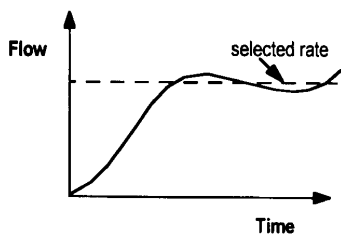

Figure 8-1 Startup Graph Example

The startup graph was developed in accordance with IEC 60601-2-24. The startup data shown in the graph illustrates the startup performance of the Colleague Pump during the first 120 minutes of operation with a sampling period of 30 seconds.

A startup graph of flow versus time (Figure 8-1) illustrates initial stability with time. Even with the proper components and set up, the flow of any manufacturer's pump may be erratic during the 120-minute startup period. Therefore, we have included the startup, or stabilization data. It should be noted that as the time interval over which accuracy is measured is lengthened, all pumps show considerable improvement in flow accuracy.

How Trumpet Curve Graphs are Interpreted

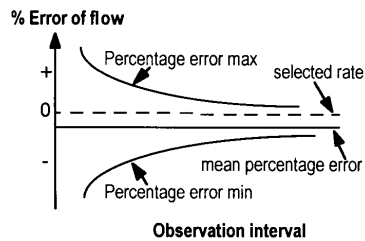

Figure 8-2 Trumpet Graph Example

The trumpet curve (Figure 8-2) provides a graphical view of the maximum deviation in flow rate from the programmed delivery rate for specific segments of delivery time. The horizontal axis does **not** represent elapsed delivery time, but rather acts as a graphical reference for selecting specific observation time intervals. The widest area of the trumpet curve (greatest deviation) reflects the smallest sampling intervals or observation windows. As the sizes of the sampling intervals increase (in minutes), the deviations in flow from the programmed delivery rate are reduced as the deviations are spread out over the longer periods of time. This results in the narrowing of the trumpet curve giving a more realistic representation of the pump's average flow rate accuracy over longer intervals of time.

For example, if you were to look at the maximum and minimum percentage error points corresponding to the 5-minute interval point on the Observation Interval axis, you would be looking at the average flow variance for any 5-minute period throughout the infusion.

Similarly, if you were to look at the 60-minute interval point on the Observation Interval axis, you would be looking at the average flow variance for any 60-minute period throughout the infusion.

How Trumpet Curve Graphs are Created

The trumpet curve graphs were developed in accordance with data collection and manipulation methods defined in IEC 60601-2-24.

The trumpet curve graphs were created in the following manner:

- Fluid from the pump is collected at the set flow rates over 72 hours.
- Every 30 seconds, the cumulative weight of the fluid is recorded.
- The data from the collection period are divided into observation or time windows and the flow rate accuracy is determined for each window.
- The maximum and minimum deviations from the set flow rate for various window sizes (2, 5, 11, 19, and 31 minutes) are plotted on a graph.
- These plotted points are connected to form the trumpet-shaped lines.
- Lines are then drawn to connect the plotted points to create the trumpet curve.

How Trumpet Curves can be Used

Trumpet curves can be important sources of information for the medical professional who must decide whether a certain infusion pump can be used with a particular drug. For example, when delivering a drug with a short half-life, very small deviations in flow over the course of an infusion would be desirable to ensure that the deviations in plasma level also remained small. The pump's ability to deliver very closely to the programmed rate would ensure that the drug's efficacy was being maintained. In this example, the medical professional would be wise to select a pump whose trumpet curve indicated a small or narrow range of deviations in flow rate.

Accuracy Test per Sub-Clause 50.4 of IEC 60601-2-24 Part 2 at 1 mL/hr

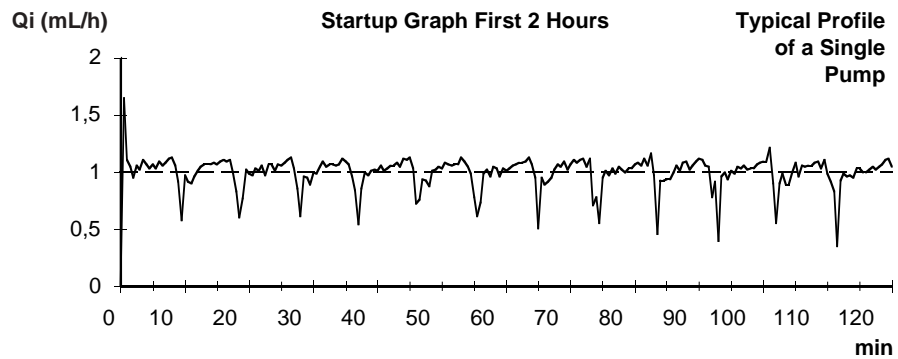

Figure 8-3 Delivery Startup, First Two Hours, 1 mL/hr

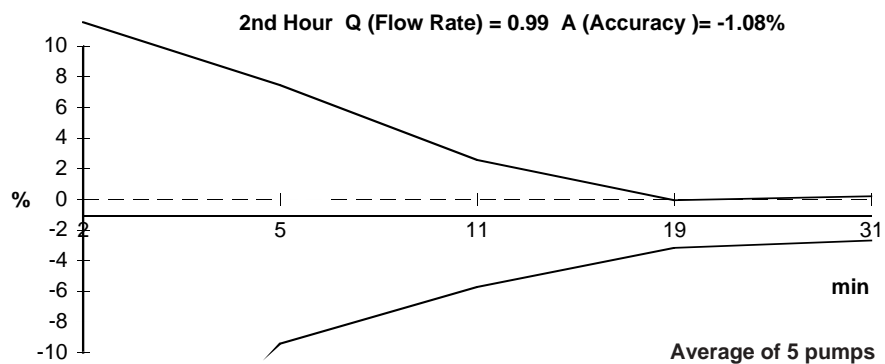

Figure 8-4 Trumpet Graph, 2nd Hour of Delivery, 1 mL/hr

Technical Specifications

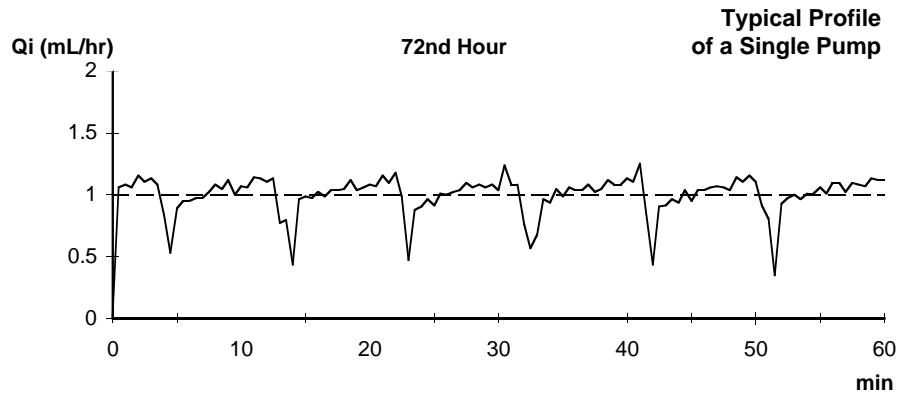

Figure 8-5 Flow Accuracy, 72nd Hour, 1 mL/hr

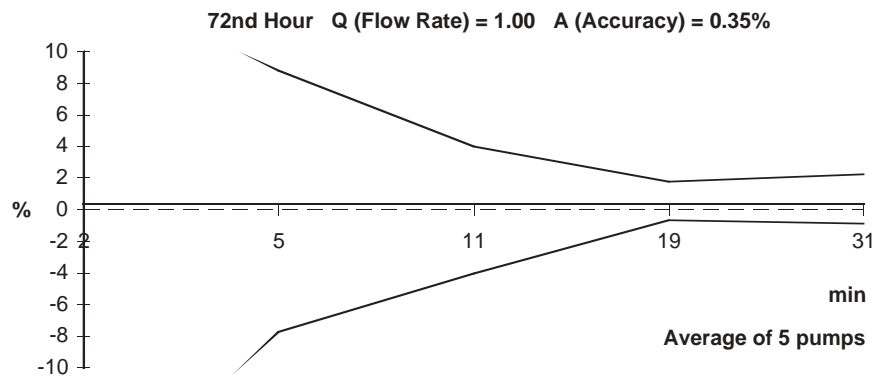

Figure 8-6 Trumpet Graph, 72nd Hour of Delivery, 1 mL/hr

8

Accuracy Test per Sub-Clause 50.4 of IEC 60601-2-24 Part 2 at 25 mL/hr

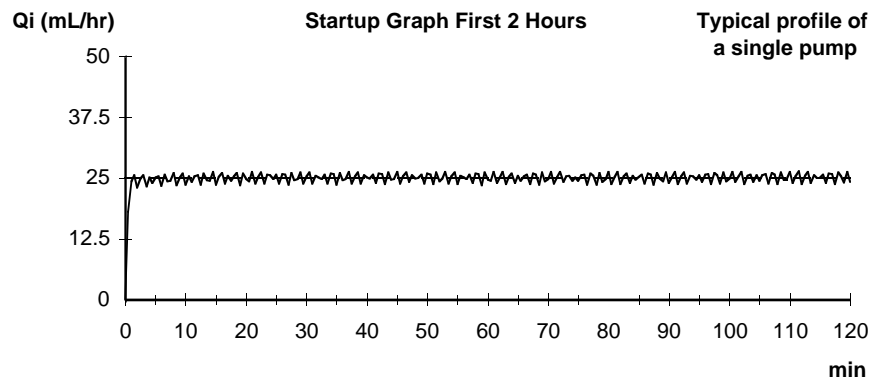

Figure 8-7 Delivery Startup, First Two Hours, 25 mL/hr

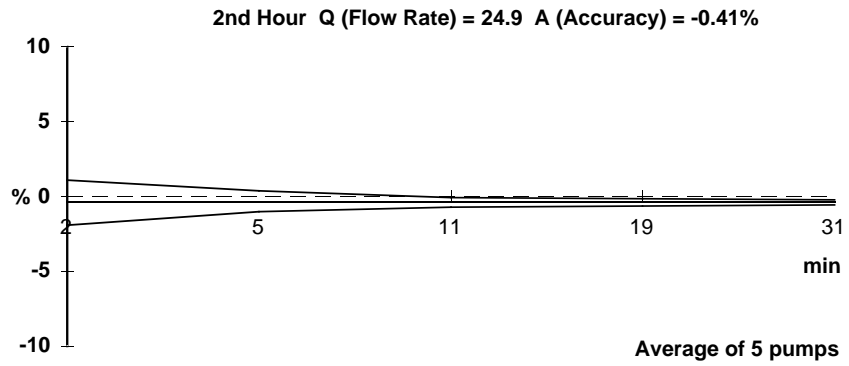

Figure 8-8 Trumpet Graph, 2nd Hour of Delivery, 25 mL/hr

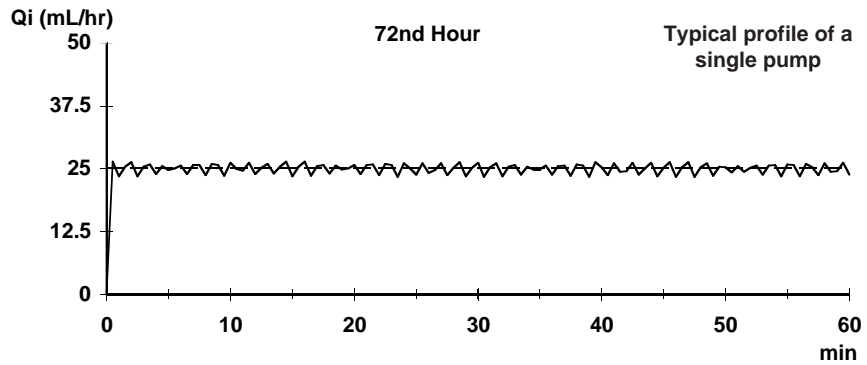

Figure 8-9 Flow Accuracy, 72nd Hour, 25 mL/hr

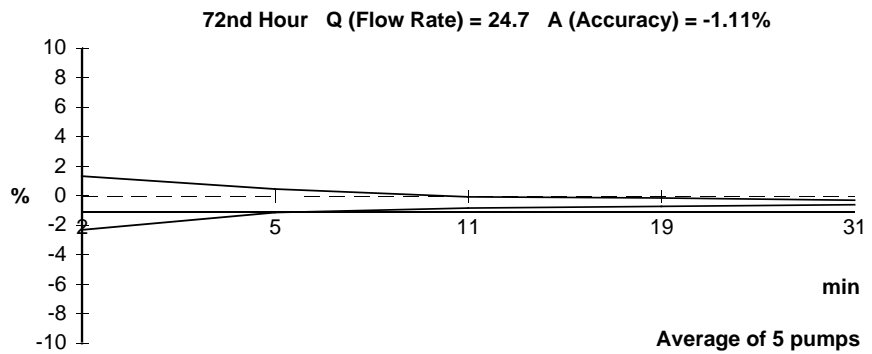

Figure 8-10 Trumpet Graph, 72nd Hour of Delivery, 25 mL/hr

1. Influences of Back Pressure at 25mL/hr

A maximum deviation of up to 5%* may result when the back pressure is increased from 0 to +100 mmHg when tested per Sub-Clause 50.4 of IEC 60601-2-24 Part 2. A typical deviation under these conditions is 1.2%.

A maximum deviation of up to 6.4%* may result when the back pressure is decreased from 0 to -100 mmHg when tested per Sub-Clause 50.4 of IEC 60601-2-24 Part 2. A typical deviation under these conditions is 4.0%.

*At least 90% of the observed values (95% confidence) will lie below the limits shown for the indicated settings.

2. Influences of Source Container Position at 25mL/hr

A maximum deviation of up to -4.4%* may result when the source container is repositioned from 50cm above the pump to -50 cm below the pump when tested per Sub-Clause 50.4 of IEC 60601-2-24 Part 2. A typical deviation under these conditions is -2.5%.

*At least 90% of the observed values (95% confidence) will lie below the limits shown for the indicated settings.

3. Maximum Infusion Pressure Generated

The maximum infusion pressure prior to alarm activation is 931 mmHg (18 psi) at 25 mL/hr when tested per Sub-Clause 51.6a of IEC 60601-2-24 Part 2.

*At least 90% of the observed values (95% confidence) will lie below the limits shown for the indicated settings.

The information in the following tables represents laboratory testing conducted per Sub-Clause 51.6b of IEC 60601-2-24 Part 2.

4. Time to Detect Downstream Occlusions

Rate	Occlusion Alarm Pressure Setting	Typical Time to Alarm Activation	Maximum Time to Alarm Activation*
1 mL/hr	Minimum 103 mmHg (2 psig)	4 min 6 sec	7 min 59 sec
	Moderate 258 mmHg (5 psig)	6 min 47 sec	13 min 44 sec
	Maximum 465 mmHg (9 psig)	12 min 55 sec	26 min 58 sec
25 mL/hr	Minimum 206 mmHg (4 psig)	0 min 17 sec	0 min 27 sec
	Moderate 413 mmHg (8 psig)	0 min 32 sec	0 min 52 sec
	Maximum 620 mmHg (12 psig)	0 min 47 sec	1 min 12 sec

*At least 90% of the observed values (95% confidence) will lie below the limits shown for the indicated settings.

5. Bolus Volume Released After Downstream Occlusions Are Corrected

Rate	Occlusion Alarm Pressure Setting	Typical Bolus Volume	Maximum Bolus Volume*
1 mL/hr	Minimum 103 mmHg (2 psig)	0.057 mLs	0.16 mLs
	Moderate 258 mmHg (5 psig)	0.110 mLs	0.20 mLs
	Maximum 465 mmHg (9 psig)	0.177 mLs	0.26 mLs
25 mL/hr	Minimum 206 mmHg (4 psig)	0.079 mLs	0.20 mLs
	Moderate 413 mmHg (8 psig)	0.178 mLs	0.55 mLs
	Maximum 620 mmHg (12 psig)	0.245 mLs	0.72 mLs

*At least 90% of the observed values (95% confidence) will lie below the limits shown for the indicated settings.

6. Maximum Volume Under Single Fault Condition

For flow rate ≥ 1.0 mL/hr, worst case volume is 20% of set VTBI.

For flow rate < 1.0 mL/hr, worst case volume is 25% of set VTBI or 1.33 mL, whichever is greater.

Configurable Options

Overview

This chapter lists the pump's configurable features and their initial factory settings.

As described earlier, specific features or settings can be varied based upon your care site's clinical needs. See Chapter 5 for a description of the Pump Personality Feature Sets for more information.

Note: To create a custom Personality feature set or to change initial factory settings, see the *Colleague Global Service Manual*. The setting named Permanent Settings cannot be changed.

Note: Authorized healthcare professionals should establish the settings appropriate for each custom Personality feature set based upon the care site's clinical needs.

Note: Changes to the configurable settings can only be made by authorized personnel. To change settings, an access code is required.

Note: Program Memory Retention Time is set to 5 hours. This is the amount of time the pump retains infusion parameters and the Personality feature set selection when the pump is turned off.

Note: Nurse Call is always available and produces constant output.

Configurable Options List

Pump Configurable Items

When enabled, the following items affect the entire pump:

- Personality Names and Configuration Settings
- Set Time and Date

Personality Feature Set Configurable Settings

When enabled, the following items affect each Personality feature set:

Infusion Modes

- Rate-Volume (This mode is always available and cannot be disabled.)
- Enable/Disable Volume-Time
- Enable/Disable Piggyback
- Enable/Disable Dose - If Dose is enabled, the following formulas can be selected:
 - mg/min, mg/hr
 - mcg/min, mcg/hr
 - units/hr, units/kg/hr
 - mg/kg/min, mg/kg/hr
 - mcg/kg/min, mcg/kg/hr

Features

- Set Pump Channel display option
- Enable/Disable Prime
- Enable/Disable Flow Check display availability

Infusion Limits, Alerts and Alarms

- Set Flow Rate limits
- Set VTBI limits
- Set KVO rates
- Set Air Alarm Sensitivity
- Set Downstream Occlusion limits
- Enable/Disable Clinician Override of Occlusion limits
- Set number of Auto restarts after Downstream Occlusion
- Enable/Disable Piggyback Callback alert
- Set Alert off interval
- Set Alarm off interval
- Enable/Disable Auto Lock

Label Library

- Enable/Disable Label Library Feature - If the Label Library is enabled, labels can be selected for use from the predefined list. Custom labels can also be programmed if desired. (See “Label Library,” 9-5.)

Option	Available Settings	Factory Settings																				
Prime Feature (Enables priming for administration sets difficult to gravity-prime.)	Available (Enable) Unavailable (Disable)	Enabled																				
Flow Check Display (Provides visual indication of distal resistance to flow.)	Always displayed when the pump is running (Enable) Display on demand (Disable)	Disabled																				
Infusion Flow Rate Limits (Piggyback limited to 500 mL/hr or the rate, whichever is less.)	0.1 mL/hr to 1200 mL/hr	1200 mL/hr																				
Volume To Be Infused Limit	0.1 mL to 9999 mL	9999 mL																				
KVO Rate Limit	0.1 mL/hr to 5 mL/hr (Pump infuses at the preselected KVO rate or the programmed rate, whichever is lower.)	5 mL/hr																				
Air Bubble Setting	Measured accumulations of approximately <ul style="list-style-type: none"> • 25 Microliters • 50 Microliters • 100 Microliters • 150 Microliters 	150 Microlitres																				
Nominal Downstream Occlusion Values Power On	<table border="0" style="width: 100%; text-align: center;"> <thead> <tr> <th colspan="4">Rate Range in mL/hr</th> </tr> <tr> <th><21</th> <th>21-200</th> <th>>200</th> <th></th> </tr> </thead> <tbody> <tr> <td>103 mmHg (2 psig)</td> <td>206 mmHg (4 psig)</td> <td>310 mmHg (6 psig)</td> <td>Minimum</td> </tr> <tr> <td>258 mmHg (5 psig)</td> <td>413 mmHg (8 psig)</td> <td>568 mmHg (11 psig)</td> <td>Moderate</td> </tr> <tr> <td>465 mmHg (9 psig)</td> <td>620 mmHg (12 psig)</td> <td>775 mmHg (15 psig)</td> <td>Maximum</td> </tr> </tbody> </table>	Rate Range in mL/hr				<21	21-200	>200		103 mmHg (2 psig)	206 mmHg (4 psig)	310 mmHg (6 psig)	Minimum	258 mmHg (5 psig)	413 mmHg (8 psig)	568 mmHg (11 psig)	Moderate	465 mmHg (9 psig)	620 mmHg (12 psig)	775 mmHg (15 psig)	Maximum	Moderate
Rate Range in mL/hr																						
<21	21-200	>200																				
103 mmHg (2 psig)	206 mmHg (4 psig)	310 mmHg (6 psig)	Minimum																			
258 mmHg (5 psig)	413 mmHg (8 psig)	568 mmHg (11 psig)	Moderate																			
465 mmHg (9 psig)	620 mmHg (12 psig)	775 mmHg (15 psig)	Maximum																			
Occlusion Override of Downstream Occlusion Pressure Settings (When enabled, clinicians can change the occlusion limit settings. Setting remains in effect until the pump is powered off.)	Available (Enable) Unable (Disable)	Enabled																				
Number of Auto Restarts after a Downstream Occlusion	0 to 9	5																				

Option	Available Settings	Factory Settings
Piggyback Callback Alert	Available (Enable) Unavailable (Disable)	Disabled
Alert Off Interval (Allows adjustment of time between audible tones.)	1 second to 7 seconds	4 seconds
Alarm Off Interval (Allows adjustment of time between audible tones.)	1 second to 7 seconds	1 second
Auto Lock	Available (Enable) Unavailable (Disable)	Disabled
Label Library Feature	Available (Enable) Unavailable (Disable)	Enabled
Select Available Labels	(YES) Enable (NO) Disable Note: Individual labels can be enabled or disabled using the Label Library Set Up soft key.	All Predefined Labels Enabled (YES) Custom Labels Disabled (NO)

Label Library

Predefined Label List

Following is a list of the predefined drug labels and abbreviations available within the label library configuration setup. The labels are categorized to assist the clinician in selecting IV line labels. The labels are not necessarily aligned with their pharmacologic category.

Name	Abbreviation
Analgesics / Anesthetics	
Alfentanil HCL	ALFENTAN
Atracurium Besylate	ATRACURI
Doxapram HCL	DOXAPRAM
Droperidol	DROPERID

Name	Abbreviation
Ketamine HCL	KETAMINE
Methohexital Sodium	METHOHEX
Mivacurium Chloride	MIVACURI
Morphine Sulfate	MORPHINE
Naloxone HCL	NALOXONE
Propofol	PROPOFOL
Rocuronium Bromide	ROCURONI
Succinylcholine Chloride	SUCCINYL
Sufentanil Citrate	SUFENTANI
Vecuronium Bromide	VECURONI
Antibiotics	
Cefazolin Sodium	CEFAZOLI
Anticoagulants	
Alteplase	ALTEPLAS
Heparin Sodium	HEPARIN
Streptokinase	STREPTOK
Urokinase	UROKINAS
Antineoplastic Agents	
Carboplatin	CARBOPLA
Carmustine	CARMUSTI
Cisplatin	CISPLATI
Cyclophosphamide	CYCLOPHO
Doxorubicin HCL	DOXORUBI
Etoposide	ETOPOSID
Fluorouracil	FLUOROUR
Ifosfamide	IFOSFAMI
Methotrexate Sodium	METHOTRE
Plicamycin	PLICAMYC

Name	Abbreviation
Cardiovascular Drugs	
Aminophylline	AMINOPHY
Amrinone Lactate	AMRINONE
Bretylium Tosylate	BRETyliU
Diltiazem HCL	DILTIAZE
Lidocaine HCL	LIDOCAIN
Methyldopate HCL	METHYLDO
Nitroglycerin	NITROGLY
Nitroprusside	NITROPRU
Procainamide HCL	PROCAINA
Prostaglandin E1	PROSTAGL
Tolazoline HCL	TOLAZOLI
Trimethaphan Camsylate	TRIMETHA
Labor and Delivery	
Magnesium Sulfate	MAGNESIU
Oxytocin	OXYTOCIN
Ritodrine HCL	RITODRIN
Vasoactive Drugs	
Dobutamine HCL	DOBUTAMI
Dopamine HCL	DOPAMINE
Esmolol HCL	ESMOLOL
Isoproterenol HCL	ISPROTER
Labetalol HCL	LABETALO
Metaraminol Bitartrate	METARAMI
Milrinone Lactate	MILRINON
Norepinephrine Bitartrate	NOREPINE
Phenylephrine HCL	PHENYLEP

Application Labels

Name	Abbreviation
Antibiotic	ANTIBIOT
Arterial Line	ARTERIAL
Blood	BLOOD
Central Line	CENTRALL
Epidural	EPIDURAL
Keep Vein Open	KVO
Lipids	LIPIDS
Maintenance Line	MAINTENA
Total Parenteral Nutrition	TPN
Umbilical Arterial Catheter	UAC
Umbilical Venous Catheter	UVC

Custom Labels

The pump allows programming of up to 32 custom labels in addition to the pre-configured label library. When the Label Library feature is enabled, the user can select from the pre-configured and custom labels. Custom labels appear in the list in alphabetical order.

See the *Colleague Global Service Manual* for instructions on configuring custom labels.

Warranty and Service Information

Warranty

Baxter warrants that the equipment shall be free from defects in material and workmanship when delivered to the original purchaser. Baxter's sole obligation shall be to repair or replace the product (excluding batteries), at Baxter's option and expense, for a period of one year following the date of initial delivery. The warranty period for batteries is limited to a period of six months following the date of initial delivery.

The warranty extends only to the original purchaser and is not assignable or transferable, and shall not apply to auxiliary equipment or disposable accessories. There are risks associated with using anything other than the recommended Baxter designated IV administration sets with this device. Baxter's warranty to repair or replace the product will be null and void if this product is used contrary to the directions for use contained in the labeling or if used with non-recommended sets. Baxter will assume no responsibility for incidents which may occur if the product is not used in accordance with product labelling.

THERE ARE NO OTHER WARRANTIES INCLUDING ANY IMPLIED WARRANTY AND ANY WARRANTY OF MERCHANTABILITY OR FITNESS FOR A PARTICULAR PURPOSE WHICH EXTEND BEYOND THE DESCRIPTION OF THE PRODUCT AND THOSE EXPRESSLY SET FORTH IN ITS LABELLING. In no event shall Baxter be responsible for incidental, consequential or exemplary damages. Modification, alteration, recalibration, or abuse, and service by other than a Baxter authorized representative may void the warranty.

Service Information

While under Baxter's warranty, Service Agreement (optional), or lease agreement, the instrument must not be opened by unauthorized personnel.

Use only an authorized Baxter service provider for service and repair. For service and repair information for this product, call the authorized service center.

In the event that your pump needs to be returned for service, obtain a Return Authorization by calling 1-800-THE-PUMP or your local service center. Shipping costs for all pumps returned to Baxter shall be paid for by the customer. The pump must be packed in its original container or in another Baxter approved container that will provide adequate protection during shipment. To ensure prompt return, a Baxter authorized service representative must be notified before shipping any pump for repair. When calling for service, please be prepared to provide code number and serial number of the pump. A brief written description of the problem should be attached to the pump when it is returned for service.

Baxter will not be responsible for unauthorized returns or for pumps damaged in shipment due to improper packing.

Authorized Service Centers

In North America, call 1-800-THE-PUMP for service and repair information.

Elsewhere, visit www.baxter.com/customers/cust_svc/index.html or call your Baxter Customer Service representative to locate the nearest service center.

Index

A

- accessories 1-8, 5-22
 - configuration transfer cable 5-22
 - event history download kit 5-23
 - syringe adapter 5-22
- accuracy
 - data 8-4
 - influences of back pressure 8-9
 - influences of source container position 8-9
 - tests 8-6
- administration sets
 - change interval 3-5
 - for use in EEC countries 3-4
 - for use in Latin America 3-4
 - for use in United States 3-4
 - preparation 3-5
 - preparing piggyback 3-17
 - unloading after pump failure 6-12
- advance air alert message 6-2
- advance air volume limit screen 6-3
- air bubble setting 8-2
- air detected alarm 6-5
- air removal
 - manual 6-6
 - pump-assisted 6-6
- air sensor 8-2
- alarm messages
 - air detected 6-5
 - battery depleted 6-8
 - close regulating clamp 6-8
 - downstream occlusion 6-8
 - incomplete primary program 5-10
 - incomplete program 6-8
 - out of range 6-8
 - reset manual tube release 6-9
 - temperature too low 6-9
 - troubleshooting 6-5
 - tube loading 6-9
 - tube misloaded 6-9
 - tube not loaded 6-9
 - upstream occlusion 6-9
- alarm silence key 2-3
- alert messages
 - advance air 6-2
 - changing primary program 6-4
 - channel stopped 6-4
 - description 6-1
 - lithium battery low 6-4
 - piggyback callback 3-16, 6-4
 - prime 6-4
 - programming piggyback 6-4
 - troubleshooting 6-1
- application labels 9-8
- auto restart 4-5
 - description 8-3

B

- back light key 2-3
- battery
 - charge level indicator 4-5
 - charging 7-3
 - disposal 7-3
 - icon 2-4
 - initial charging time 1-5, 3-1
 - operation 7-3
- battery charge 2-11
- battery charge icon 2-11
- battery depleted alarm 6-8
- bolus volume after clearing occlusions 8-10

C

- care sites 1-1
- caution statements 1-8
- caution summary 1-8
- CE mark
 - meaning of vii
- changing flow rate during an infusion 3-19
- changing mounting clamp position 3-3
- changing primary program alert 6-4
- channel failure 6-10
- channel failure pop-up 6-11
- channel stopped alert 6-4
- charging the battery 7-3

- cleaning
 - overview 7-1
 - solutions 7-1
- clear key 2-4
- clearing volume history 3-20
- clinician override 4-4
- close regulating clamp alarm 6-8
- communication port 2-8, 5-23
- completing a primary infusion 3-15
- computer control icon 2-4
- configurable options
 - callback alert 3-16
 - listing of 9-1
- configuration transfer cable 5-22
- container preparation 3-5
- contrast control 2-8

D

- delivery accuracy 8-4
- description
 - icons 2-4
 - keys 2-3
 - LEDs 2-7
 - main display 2-5, 2-9
 - main display icons 2-11
 - menus 2-10
 - numeric keypad 2-4
 - pop-up
 - defined 2-10
 - programming screens 2-10
 - pump labels 2-12
 - pump module 2-6
 - pump module display 2-6
 - pump module keys 2-7
 - rear panel features 2-8
 - serial number 1-7
- diluent volume 5-8
- display
 - illustration 2-5
 - main 2-5
 - more than one screen 2-11
 - pop-up window 2-5
 - pump module 2-6
- disposing of batteries 7-3
- dose programming
 - available formulas 5-12
 - based on patient weight 5-11
 - entering diluent volume 5-8
 - entering dose 5-8

- entering VTBI 5-9
- stopping an infusion 5-14
- downstream occlusion
 - alarm values 4-4, 8-2
- drop icon 2-11
- drug labels 9-5

E

- EEC administration sets 3-4
- enabling standby mode 5-20
- entering diluent volume 5-8
- entering dose 5-8
- entering volume to be infused 3-14
- environmental operating limits 8-3
- epidural infusion warning 1-8
- event history download kit 5-23
- exiting standby mode 5-21

F

- failure
 - channel 6-10
 - messages 6-10
 - troubleshooting 6-10
- features
 - fluid delivery applications 1-1
 - overview 1-3
- flow check
 - description 2-11
 - display 4-2
 - icon 2-11
- flow rate
 - changing 3-19
- fluid detected screen 6-3
- fluid icon 2-11
- formulas for dose programming 5-12
- front panel illustration 2-2
- fuse holders 2-8

G

- graphs
 - startup 8-4
 - trumpet curve 8-5

H

- headboard mounting of pump 3-2
- history 3-20

I

- icons 2-4
 - air 2-11
 - battery 2-4
 - computer control 2-4
 - description 2-4
 - flow check 4-2
 - lock 3-21
 - main display 2-11
 - monitor 2-4
 - plug 3-1
- IEC 60601-1 1-5
- IEC 60601-1-1 5-22
- IEC 60601-2-24 1-5, 8-4, 8-5
- illustration
 - changing mounting clamp orientation 3-3
 - front of pump 2-2
 - label locations 2-12
 - programming modes menu 2-10
 - programming screen 2-10
 - pump module 2-6
 - rear panel 2-8
 - using manual tube release 3-11
- incomplete primary programming alarm 5-10
- incomplete programming alarm 6-8
- infusion
 - piggyback 3-16
 - stopping 3-15
 - stopping before completion 3-15
- installation 3-1
- international standards 1-5
- IV pole mounting 3-2

K

- keypad
 - description 2-4
 - locking 3-21
- keys
 - alarm silence 2-3
 - back light 2-3
 - clear 2-4
 - description 2-3
 - main display 2-3
 - on/off 2-3
 - pump module 2-7
 - rate 2-3
 - silence key 6-1
 - soft 2-5
 - start 2-3

- stop 2-7
- volume history 2-3, 3-20

KVO

- display, defined 3-15
- piggyback 3-17

L

- label library
 - definition 9-2
 - predefined label list 9-5
- labeling
 - information and locations 2-12
 - label part numbers 2-12
 - symbol definitions 1-6
- labels
 - application 9-8
- Latin American administration sets 3-4
- LEDs 2-7
- list of recommended cleaners 7-1
- list of service centers 10-2
- lithium battery low alert 6-4
- location of pump labels 2-12
- location of speakers 2-8
- lock icon 2-11, 3-21
- locking the keypad 3-21

M

- main display
 - description 2-9
 - icons 2-11
 - key 2-3
- maintenance 7-2
- manual tube release
 - location 2-8
 - resetting 3-12
 - resetting after channel failure 6-12
 - screen 3-12
 - using 3-11
- manually purging air in tubing 6-6
- maximum infusion pressure 8-9
- menus 2-10
- monitor icon 2-4
- mounting clamp
 - changing orientation 3-3
 - headboard mount 3-2
 - IV pole mounting 3-2
 - location 2-8
 - overview 3-1

-
- N**
- nurse call 5-22
- O**
- occlusion
 - bolus volume released following 8-10
 - maximum pressure 8-9
 - time to detect 8-10
 - on/off key 2-3
 - open key 2-7
 - operating temperature 6-9
 - options
 - accessories 5-22
 - auto restart 4-5
 - battery charge level 4-5
 - clinician override 4-4
 - prime function 5-17
 - volume-time programming 5-15
 - options menu
 - exiting 4-2
 - using 4-1
 - out of range alarm 6-8
- P**
- panel lock 3-21
 - panel lockout button 2-8
 - panel, rear. See rear panel.
 - parameter retention period 5-19
 - Personality feature sets
 - overview 5-23
 - selecting 5-24
 - settings 9-1
 - viewing current 4-3
 - piggyback 2-11
 - callback alert 3-16
 - icon 2-11
 - preparing administration set 3-17
 - programming 3-16
 - select screen 3-17
 - stopping 3-18
 - VTBI 3-17
 - plug icon 3-1
 - pop-up
 - advance air 6-6
 - channel failure 6-11
 - defined 2-5
 - panel locked 3-21
 - prime active 5-18
 - prime warning 5-18
 - standby 5-20
 - pop-up window 2-10
 - predefined label list 9-5
 - preparing piggyback infusions 3-17
 - preparing the infusion container 3-5
 - pressure maximum 8-9
 - preventive maintenance 7-2
 - primary infusion 3-13
 - prime alert 6-4
 - priming 5-17
 - programming 3-17
 - dose based on patient weight 5-11
 - for future use 5-21
 - piggyback infusion 3-16
 - primary rate-volume infusion 3-13
 - volume-time 5-15
 - programming modes menu
 - illustration 2-10
 - programming piggyback alert 6-4
 - programming screen description 2-10
 - pump
 - accessories 5-22
 - configurable options 9-1
 - failure 6-10
 - icon 2-4
 - labeling locations 2-12
 - labels 2-12
 - setup 3-1
 - specifications 8-1
 - pump assisted air removal 6-6
 - pump module
 - description 2-6
 - illustration 2-6
 - keys 2-7
 - LEDs 2-7
 - symbols 2-7
- R**
- rate key 2-3
 - rate-volume programming screen 3-13
 - rear panel
 - description 2-8
 - illustration 2-8
 - recommended administration sets 3-4
 - releasing tubing manually 3-11
 - reset manual tube release
 - alarm 6-9
 - procedure 3-12

resetting manual tube release after channel failure 6-12
return shipping information 10-2

S

safety
definition of warnings and cautions 1-6
summary 1-5

screens
advance air pop-up 6-6
advance air volume limit 6-3
advancing air 6-2, 6-6
battery charge level indicator 4-6
clear stored settings 5-12
confirm settings prompt 5-10
enter new rate 3-19
enter piggyback VTBI 3-17
enter time duration 5-16
enter volume to be infused 3-14
entering dose 5-9
entering VTBI 5-9
fluid detected 6-3, 6-7
front panel locked pop-up 3-21
infusion stopped 3-15
KVO display 3-15
main display with primary running 3-14
maximum advance air volume pumped 6-7
new rate running 3-19
occlusion alarm values 4-4
piggyback stopped 3-18
prime active 5-19
rate-volume programming 3-13
ready to prime 5-18
reset manual tube release 3-12
restore settings soft key 5-14
select piggyback 3-17
select piggyback callback 3-16
value high prompt 5-8
value HIGH relieved 5-8
volume history 3-20
volume-time programming 5-16

selecting a feature set 5-24

serial number 1-7

service information 10-2

setting up the pump 3-1

silence key 6-1

soft key 2-5

specifications 8-1
environmental 8-3

standards
IEC 60601-1 1-5, 5-22
IEC 60601-2-24 1-5, 8-4, 8-5

standby
enabling 5-20
exiting 5-21
overview 5-19
pop-up 5-20
program parameter retention 5-19
programming for future use 5-21

start key 2-3

starting an infusion 3-14

startup graphs 8-4

stop icon 2-11

stop key 2-7

stopping
dose program 5-14
infusion 3-15
infusions before completion 3-15
piggyback infusions 3-18
primary infusion 3-15

storage 7-4

summary
cautions 1-8
warnings 1-7

symbols
CE mark vii
shown on labeling 1-6

syringe adapter 5-22

T

tamper prevention 3-21

technical specifications 8-1

temperature too low alarm 6-9

tracking requirements, U.S. 1-10

transferring configurable settings from one pump to another 5-22

troubleshooting
air detected alarm 6-5
alarms 6-5
alerts 6-1
battery depleted alarm 6-8
changing primary program alert 6-4
channel stopped alert 6-4
close regulating clamp alarm 6-8
downstream occlusion alarm 6-8
failures 6-10
incomplete program alarm 6-8
lithium battery low alert 6-4

out of range alarm 6-8
overview 6-1
piggyback callback alert 6-4
prime alert 6-4
programming piggyback alert 6-4
pump failures 6-10
reset manual tube release alarm 6-9
temperature too low alarm 6-9
tube loading alarm 6-9
tube misloaded alarm 6-9
tube not loaded alarm 6-9
upstream occlusion alarm 6-9
trumpet curves 8-5
tube loading alarm 6-9
tube misloaded alarm 6-9
tube not loaded alarm 6-9

U

U.S. administration sets 3-4
UL2601-1 5-22
unlocking the keypad 3-21
upstream occlusion alarm 6-9
using accessories with the pump 5-22

using the configuration transfer cable 5-22
using the options menu 4-1
using the pump's prime function 5-17

V

viewing selected Personality 4-3
volume control 2-8
volume history
 clearing 3-20
 key 2-3, 3-20
 overview 3-20
 viewing 3-20
volume key 2-3
volume-time programming 5-15
volumetric accuracy 8-4
VTBI
 piggyback 3-17

W

warning
 epidural infusions 1-8
 summary 1-7
warranty 10-1

This manual was printed on paper stock created with 20% de-inked post-consumer waste fiber and a total of 100% recycled fiber.



Baxter

Authorized Representative:
Baxter S.A.
Lessines, B7860, BELGIUM



Baxter Healthcare Corporation
Deerfield, IL 60015 USA
© Copyright 1998 - 2002, Baxter Healthcare Corporation. All Rights Reserved.

Revision E
July 2002