

Medley[™]

Medication Safety System

Syringe Module, Model 8110

Directions for Use

TABLE OF CONTENTS

INTRODUCTION

ABOUT THE SYSTEM	1
FEATURES AND DEFINITIONS	3
SYMBOLS	7

GETTING STARTED

WARNINGS AND CAUTIONS	9
CONTROLS AND INDICATORS	16
INSTALLATION	17
Unpacking Syringe Module	17

ATTACHING AND DETACHING CHANNELS	17
--	----

DISPLAYS	18
Main Display	18
Dynamic Pressure Display	19

START-UP	19
Powering On System	19
Responding to Maintenance Reminder	19
Selecting New Patient and Profile Options	19
Entering Patient ID	19
Modifying Patient ID	19

PREPARING INFUSION	20
Preparing Syringe and Administration Set	20
Loading Syringe and Administration Set	20
Selecting Syringe Type and Size	24
Priming	26

BASIC INFUSION	31
Starting Rate / Volume Infusion	32
Starting Volume / Duration Infusion	33
Possible End of Infusion Messages and Alerts	35
Pausing Infusion	36
Restarting Infusion Following Infusion Complete	37
Changing Rate or VTBI During Infusion	38
Stopping Infusion	38
Selecting Pressure Limit	38
Viewing and Clearing Volume Infused	40
Changing Syringe During Infusion	41

CHANNEL LABELS	42
Selecting Channel Label	42
Removing Channel Label	43

POWERING OFF	43
Powering Off System	43
Powering Off Channel	43

SETTING UP DRUG CALCULATION	44
Drug Calculation Parameters	44
Using Guardrails® Drug Library	45
Using Non-Library Drug	50

INTRODUCTION

GETTING STARTED

ALARMS, ERRORS,
MESSAGES

MAINTENANCE

APPENDIX

GETTING STARTED (Continued)	
PROGRAMMING BOLUS DOSE	56
Using Guardrails® Drug Library Calculation	56
Using Non-Library Drug Calculation	62
Stopping Bolus Dose	64
Restoring Bolus Dose	65
ANESTHESIA MODE	68
Enabling Anesthesia Mode	68
Disabling Anesthesia Mode	69
DELAY OPTIONS	71
Delaying Infusion	71
Scheduling a Callback	75
Pausing Infusion	77
MULTIDOSE MODE	78
Programming with Volume/Duration Enabled	78
Programming with Volume/Duration Disabled	82
REVIEWING SERIAL NUMBER	85
REVIEWING SOFTWARE VERSION	85
ALARMS, ERRORS, MESSAGES	
DEFINITIONS	87
AUDIO CHARACTERISTICS	88
ALARMS	89
Syringe Adjustment Alarms	90
ERRORS	91
MESSAGES	91
MAINTENANCE	
SPECIFICATIONS	93
CONFIGURABLE SETTINGS	96
System Settings	96
Shared Infusion Settings (Pump Module and Syringe Module)	96
Syringe Module Settings	97
COMPATIBLE SYRINGES	97
CLEANING	98
INSPECTION REQUIREMENTS	98
SERVICE INFORMATION	98
WARRANTY	99
APPENDIX	
TRUMPET AND START-UP CURVES	101

GENERAL CONTACT INFORMATION

Customer Advocacy

For clinical and technical questions, feedback, and troubleshooting assistance.

Phone, toll-free, within the United States and Canada: (800) 854-7128, Ext. 7812

E-Mail: CustomerFeedback@alarismed.com

Technical Support

For technical information related to maintenance procedures and service manual support.

United States:

Phone:

(858) 458-6003

Toll-free: (800) 854-7128, Ext. 6003

Canada:

Phone, Toll-free:

Eastern: (800) 908-9918

Western: (800) 908-9919

For more detailed information, refer to the "Service Information" section of this document.

THIS PAGE
INTENTIONALLY
LEFT BLANK

About the System

The Medley™ Medication Safety System is a modular infusion and monitoring system intended for use in today's growing professional healthcare environment, for use in adult, pediatric and neonatal care.

The Medley™ Medication Safety System consists of the Programming Module (8000 Series), the Guardrails® Safety Software, and up to four detachable modules (or "channels"), which provide infusion or monitoring capabilities.

NOTE: *The Medley™ Programming Module name will be changing in the near future to Medley™ Point-of-Care Unit.*

The Medley™ Syringe Module (Model 8110) is intended for facilities that utilize infusion pumps for the delivery of fluids, medications, blood, and blood products using continuous or intermittent delivery through clinically acceptable routes of administration; such as, intravenous (IV), intra-arterial (IA), subcutaneous, epidural, enteral, or irrigation of fluid spaces.

Guardrails® Safety Software for the Medley™ System brings a new level of medication error prevention to the point of patient care. The Guardrails® Safety Software features medication dosing guidelines for up to ten patient-specific care areas, referred to as profiles. Each profile contains a specific drug library and channel labels, as well as instrument configurations appropriate for the care area. Optional drug-specific Guardrails® Clinical Advisories provide visual messages. Dosing limits for each drug entry may be either Guardrails® Hard Limits that cannot be overridden during infusion programming or Guardrails® Soft Limits that can be overridden, based on clinical requirements.

A data set is developed and approved by the facility's own multi-disciplinary team using the Guardrails® Editor, the PC-based authoring tool. A data set is then electronically transferred to the Medley™ System by qualified personnel. The approved data sets are maintained by the Guardrails® Editor for future updates and reference.

Information about Guardrails® Alerts that occur during use is stored within the Medley™ Programming Module, and can be accessed using the Guardrails® Continuous Quality Improvement (CQI) Event Tracker and Guardrails® CQI Event Reporter.

About the System (Continued)

This document provides directions for use for the Medley™ Syringe Module. Read all instructions, for both the Syringe Module and Programming Module, before using the Medley™ System.

The Medley™ Syringe Module uses standard, single-use, disposable syringes (with luer-lock connectors) and administration sets, designed for use on syringe pumps. For specific administration set instructions, refer to the directions for use provided with the set. For set priming and loading instructions, refer to the “Preparing Infusion” section in the “Getting Started” chapter of this document.

Contraindications: None known.

Features and Definitions

Refer to the “Alarms, Errors, Messages” chapter of this Directions for Use for the definitions of various alerts. Refer to the Medley™ Programming Module Directions for Use for system features and definitions.

ALL Mode	When ALL is selected as the volume to be infused (VTBI), the entire contents of the syringe will be delivered.
Auto Pressure	When enabled and a pressure sensing disc is in use, the Auto Pressure option is displayed in the Pressure Limit screen. Auto Pressure automatically sets the alarm limit for a shorter time to alarm, as follows: <ul style="list-style-type: none">• If current pressure is 100 mmHg or less, system adds 30 mmHg to current pressure, to create a new alarm limit.• If current pressure is greater than 100 mmHg, system adds 30% to current pressure, to create a new alarm limit.
Auto Pressure Limit Adjustment	When a bolus is delivered, the pressure alarm limits are temporarily raised to the maximum limit.
Auto Syringe Size Identification	The system automatically detects the syringe size and narrows down the syringe selection list.
Back Off	This feature is only available when the administration set in use has a pressure sensing disc. When enabled, the motor reverses plunger movement during an occlusion until the pressure returns to preocclusion levels, automatically reducing bolus flow.
Bolus Dose	The Bolus Dose mode allows a bolus infusion to be programmed using either the Guardrails® Drug Library or the drug calculation feature. The bolus infusion can be programmed with or without a continuous infusion following the bolus.
Channel Labels	The Channel Labels feature is available when the Profiles feature is enabled. It provides a hospital-defined list of labels, displayed in the Channel Message Display, and identifying the channel with the solution being infused, the catheter location, or other helpful information.
Delay Options	The Delay Options feature allows the system to be programmed to delay the start of an infusion a) for up to 120 minutes or b) for a specific time up to 23 hours 59 minutes. A callback for a programmed delay can be scheduled to give an alert Before an infusion is to be initiated, After an infusion is completed, Before and After an infusion, or no alert (None).

Features and Definitions (Continued)

Drug Calculation	<p>The Drug Calculation mode allows:</p> <ul style="list-style-type: none">• entry of drug dose (Medley™ System calculates correct flow rate to achieve desired dose), <p>OR</p> <ul style="list-style-type: none">• entry of flow rate (Medley™ System calculates corresponding drug dose).
Dynamic Pressure Display	<p>The Dynamic Pressure Display appears on the Main Display. If enabled, it graphically displays the current patient-side occlusion pressure set point and the current patient-side operating pressure for that module. (Reference “Displays” section in “Getting Started” chapter for additional “Dynamic Pressure Display” information.)</p>
Event Logging	<p>Event Logging records instrument operations.</p>
Fast Start	<p>When Fast Start is enabled and an administration set having a pressure sensing disc is used, the instrument runs at an increased rate when an infusion is first started, taking-up any slack in the drive mechanism.</p>
Guardrails® Clinical Advisory	<p>A Guardrails® Clinical Advisory is a visual message that appears when a designated drug is selected, to remind a clinician of specific hospital standards of practice when programming an IV medication. A specific clinical advisory can be associated with a selected drug within any of the patient care profiles.</p>
Guardrails® Drug Library	<p>The Guardrails® Drug Library feature is a drug calculation mode available when the Profiles feature is enabled. It provides a hospital-defined list of drugs and concentrations appropriate for use in as many as 10 profiles. Using the Drug Library automates programming steps, including the drug name, drug amount and diluent volume, and activates the hospital-established best-practice Guardrails® Limits.</p>
Guardrails® Limit	<p>A Guardrails® Limit is a programming limit or best-practice guideline determined by the hospital/health system and entered into the system’s data set. Profile-specific limits are defined for flow rate, patient weight, and maximum and minimum continuous dose for each drug in a Guardrails® Drug Library. Dose limits can be defined by the hospital/health system as either “hard” or “soft” limits.</p> <ul style="list-style-type: none">• A Guardrails® Hard Limit is a programmed limit that cannot be overridden.• A Guardrails® Soft Limit is a programmed limit that can be overridden.

Features and Definitions (Continued)

Multidose Mode	The Multidose Mode option allows 2 - 24 doses to be programmed at equally spaced intervals on the same Syringe Module over a 24-hour period. This mode is designed to allow delivery of multiple, equal doses from the same syringe at regularly scheduled intervals.
Near End of Infusion (NEOI)	The NEOI option allows an alert to be configured to sound anywhere from 1 to 60 minutes before the infusion is complete. The alert will occur at the configured time or when 25% of the VTBI remains, whichever comes later.
Occlusion Pressure	<p>A complete range of downstream occlusion detection options is provided.</p> <ul style="list-style-type: none">• With pressure sensing disc: Downstream occlusion alarm threshold is selectable between 25 and 1000 mmHg, in 1 mmHg increments.• Without pressure sensing disc: Downstream occlusion alarm threshold can be set to low, medium, or high.
Pressure Sensing Disc	<p>When installed, the pressure sensing disc significantly improves the instrument's pressure sensing capabilities for a faster occlusion detection time, and makes the following features available:</p> <p>Auto Pressure Back-Off Customizable Pressure Alarm Settings (see "Occlusion Pressure") Fast Start Pressure Tracking</p>
Pressure Tracking	The dynamic current pressure display is only available when the pressure sensing disc is inserted.
Priming	The Priming option allows a limited volume of fluid to be delivered in order to prime the administration set prior to being connected to a patient or after changing a syringe. When priming, a single continuous press of the PRIME soft key delivers up to 2 mL of priming fluid.
Restore	To simplify programming, the Restore feature can be used to recall previous rate and volume settings for the same patient. This option is only available if the patient is not new and the system is powered up within 8 hours of last usage.

Features and Definitions (Continued)

Selectable KVO	The Selectable KVO option allows some infusions to automatically switch into KVO mode upon completion. The KVO option setting cannot be changed after the instrument is powered on and a profile selected.
Syringe Empty	The instrument gives an alert and stops when an empty syringe is detected.
Syringe Volume Detection	The system automatically detects the fluid volume in a syringe when it is inserted.
Volume/Duration	The Volume/Duration infusion option allows a volume-to-be-infused (VTBI) and duration (infusion time) to be programmed. The flow rate is automatically calculated.

Symbols



Canadian and U.S. Certification Mark: Products bearing this mark have been tested and certified in accordance with applicable U.S. and Canadian electrical safety and performance standards (CSA C22.2 No. 601.1, UL 2601-1 and IEC 60601-2-24).



Electrical Shock Protection Rating: Type CF, Defibrillation-proof

IPX1

Protection against fluid ingress: Drip Proof



Attention: Refer to accompanying documentation.



IUI Connector: Inter-Unit Interface connector used to establish power and communications between the Programming Module and attached modules.



Manufacturing Date: Number adjacent to symbol indicates the month and year of manufacture.



Consult operating instructions.

Rx Only

CAUTION: Federal (U.S.A.) law restricts this device to sale by or on the order of a physician.

Single-Use



Single-Use. Do not re-use.



Product contains a particular element; such as, = DEHP in fluid pathway.



Product DOES NOT contain a particular element; such as, = administration set is latex-free.



Approximate administration set priming volume.



Expiration date for product will be identified near hour glass symbol.



Do not use if package is damaged.

THIS PAGE
INTENTIONALLY
LEFT BLANK

NOTE: Although the Medley™ Medication Safety System is built and tested to exacting specifications, it is not intended to replace the supervision of IV infusions by medical personnel. The user should become thoroughly familiar with the features and operation of the Medley™ System and exercise vigilance in its utilization.

Rx Only

WARNING

A warning is an alert to potential serious outcomes (death, injury or serious adverse events) to the patient or user.

CAUTION

A caution is an alert to take special care for the safe and effective use of the device.

Warnings and Cautions

For WARNINGS and CAUTIONS for the Programming Module, refer to its Directions for Use.

To ensure proper performance of the Medley™ System and to reduce potential injury, observe the following precautions:

Epidural Administration

The Medley™ System can be used for epidural administration of anesthetic and analgesic drugs. This application is only appropriate when using analgesics and anesthetics labeled for continuous epidural administration and catheters intended specifically for epidural use. Use only standard, single-use, disposable syringes (with luer-lock connectors) and administration sets, designed for use on syringe pumps and **without** a 'Y' connector or injection port, for epidural infusions.

- Epidural administration of anesthetic drugs: Use indwelling catheters specifically indicated for short-term (96 hours or less) anesthetic epidural drug delivery.
- Epidural administration of analgesic drugs: Use indwelling catheters specifically indicated for either short-term or long-term analgesic epidural drug delivery.

WARNING

Epidural administration of drugs other than those indicated for epidural use could result in serious injury to the patient.

WARNING

It is strongly recommended that the syringe, administration set, and Syringe Module used for epidural drug delivery be clearly differentiated from those used for other types of administration.

Warnings and Cautions (Continued)

WARNING

This instrument is designed to stop fluid flow under alarm conditions. Periodic patient monitoring must be performed to ensure the infusion is proceeding as expected.

WARNING

The Guardrails® Safety Software incorporates dosing limits and instrument configuration parameters based on hospital protocol. The software adds a test of reasonableness to drug programming based on the limits defined by the hospital. Qualified personnel must ensure the appropriateness of the drug dosing limits, the compatibility of the drugs, and the performance of each instrument, as part of the overall infusion. Potential hazards include drug interactions, and inappropriate delivery rates and pressure alarms.

WARNING

When loading a data set with the Guardrails® Safety Software, ensure the correct profile (for patient care area) is selected prior to starting an infusion. Failure to use the appropriate profile could cause serious consequences.

WARNING

The Medley™ Syringe Module is a positive displacement delivery system, capable of developing positive fluid pressures to overcome widely varying resistances to flow encountered in practice, including resistances to flow imposed by small gauge catheters, filters and intra-arterial infusion. It is neither designed nor intended to detect infiltrations and will not alarm under infiltration conditions.

WARNING

Hospital/facility personnel must ensure the compatibility of the drugs as well as the performance of each module as part of the overall infusion. Potential hazards include drug interactions, inaccurate delivery rates, inaccurate pressure alarms and nuisance alarms.

WARNING

Do not use the Medley™ System in close proximity of Magnetic Resonance Imaging (MRI).

Warnings and Cautions (Continued)

WARNING

Use only standard, single-use, disposable syringes (with luer-lock connectors) and administration sets, designed for use on syringe pumps. The use of any other syringe or administration set may cause improper instrument operation, resulting in inaccurate fluid delivery or pressure sensing, or other potential hazards. For a list of compatible syringes, refer to the “Compatible Syringes” section in the “Maintenance” chapter. For a list of compatible administration sets, refer to the Set Compatibility Card (provided separately).

WARNING

Before loading or unloading the syringe, always turn off fluid flow to the patient, using the tubing clamp or stopcock. Uncontrolled fluid flow can occur when the administration set is not clamped or turned off, and may cause serious injury or death.

WARNING

When the pressure sensing disc is not being used and an occlusion occurs, there is a risk of infusing pressurized buildup of infusates upon correction of the occlusion. To avoid an inadvertent bolus, relieve the pressure before restarting the infusion.

WARNING

When priming:

- Ensure patient is not connected.
- Ensure air is expelled from line prior to beginning infusion (unexpelled air in line could have serious consequences).

Failure to prime correctly can delay infusion delivery and cause the total volume to be infused to read higher than the actual total delivered to the patient.

WARNING

Ensure the syringe manufacturer and syringe size displayed matches the syringe manufacturer and syringe size installed in the Medley™ Syringe Module. Mismatches may cause an under-infusion or over-infusion to the patient that could result in serious injury and/or death. For a list of compatible syringes, refer to the “Compatible Syringes” section in the “Maintenance” chapter.

Warnings and Cautions (Continued)

WARNING

Installing a pressure sensing disc after an infusion has started can result in a bolus to the patient.

WARNING

The use of positive displacement infusion devices ported together with gravity flow infusion systems into a common IV site may impede the flow of common "gravity only" systems, affecting their performance. Hospital/facility personnel must ensure the performance of the common IV site is satisfactory under these circumstances.

WARNING

Each time the Medley™ System is turned on, verify and/or set the monitoring mode, resistance alert, and/or pressure alarm limit. If the monitoring mode, resistance alert, and/or pressure alarm limit are not verified, the instrument may not operate within the desired occlusion detection parameter(s).

WARNING

References in this document to specific drugs and drug doses are for illustration purposes only. Refer to specific drug product labeling for information concerning appropriate administration techniques and dosages.

Parallel Infusions

There are no contraindications regarding the use of the Medley™ System with any other positive displacement infusion device when ported together into a common IV site location.

Warnings and Cautions (Continued)

User Precautions

To ensure proper performance of the Medley™ System and to reduce potential injury to the operator, observe the following precautions:

- Disconnect from main (AC) power when performing maintenance.
- The instrument case should only be opened by qualified service personnel using proper grounding techniques.

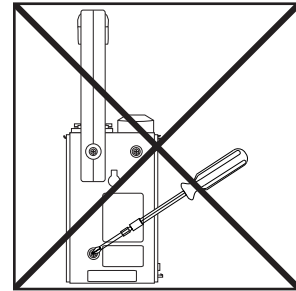

Administration Sets and Syringes

- For a list of compatible syringes, refer to “Compatible Syringes” section in “Maintenance” chapter.
- For a list of compatible administration sets, refer to Set Compatibility Card (provided separately).
- For specific administration set instructions, refer to directions for use provided with set. For set priming and loading instructions, refer to “Preparing Infusion” section of this document.
- Before operating instrument, verify that administration set is free from kinks and installed correctly in instrument.
- Syringe Module administration sets are supplied with a sterile fluid path for one-time use. Do not resterilize.
- Fluid path is STERILE and NONPYROGENIC.
- Discard if packaging is not intact or protector caps are unattached.
- For administration set replacement interval, refer to facility protocol and/or government standards (such as, CDC guidelines in the United States).
- For IV push medication (put instrument on hold), clamp tubing above the port.
- Flush port(s) per facility protocol.
- Discard administration set per facility protocol.

WARNING

Use only standard, single-use, disposable syringes (with luer-lock connectors) and administration sets, designed for use on syringe pumps. The use of any other syringe or administration set may cause improper instrument operation, resulting in inaccurate fluid delivery or pressure sensing, or other potential hazards. For a list of compatible syringes, refer to the “Compatible Syringes” section in the “Maintenance” chapter. For a list of compatible administration sets, refer to the Set Compatibility Card (provided separately).

Warnings and Cautions (Continued)

User Precautions (Continued)

Artifacts

It is normal for an infusion device to produce nonhazardous currents when infusing electrolytes. These currents vary proportional to the infusion device flow rate. When the ECG monitoring system is not functioning under optimal conditions, these currents may appear as artifacts, simulating actual ECG readings. To determine if ECG abnormalities are caused by patient condition or the ECG equipment, place the infusion device on hold. If the ECG readings become normal, the ECG equipment requires attention. Proper setup of the ECG equipment should eliminate these artifacts. Reference the appropriate ECG monitoring system documentation for instructions on setup and maintenance.

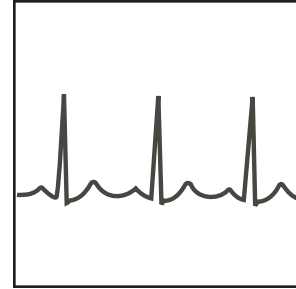

Dropping/Jarring

Should an instrument be dropped or severely jarred, it should be immediately taken out of use and inspected by qualified service personnel, to ensure its proper function prior to reuse.

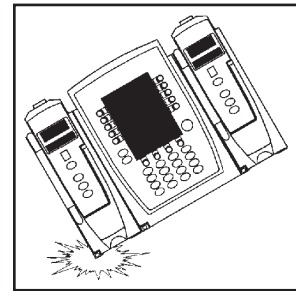

Electromagnetic Compatibility (EMC)

When using the Syringe Module in combination with a Programming Module which is interconnected to hospital data communications equipment and/or nurse call systems (signal input and signal output ports), the external systems must be certified to applicable standards to ensure correct operation and electromagnetic compliance integrity.

Interconnected data communications systems must be certified to IEC 950 (data processing equipment) or IEC 60601-1 electromedical equipment. Nurse call systems must be certified to UL 1069 (hospital signaling and nurse call equipment) or comply with the requirements specified in IEC 60601-1.

Compliance with the electromagnetic compatibility standard (IEC 60601-1-2) is a function of all interconnected equipment including cabling and, as such, it is the responsibility of the hospital/facility to ensure external equipment complies with the applicable EMC standards. Failure to verify that external equipment meets applicable EMC standards may result in degraded electromagnetic compatibility (refer to "Radio Frequency Interference" warning for additional information).

Warnings and Cautions (Continued)

User Precautions (Continued)

Operating Environment

Not for use in the presence of flammable anesthetics.

Radio Frequency Interference

Operating the system near equipment which radiates high-energy radio frequencies (electrosurgical/cauterizing equipment, portable radios, cellular telephones, etc.) may cause false alarm conditions. If this happens, reposition the device away from the source of interference or turn off the device and manually regulate the flow with the clamp and/or monitor the vital parameters using an appropriate clinical alternative.

◀ DANGER ▶

Explosion risk if used in the presence of flammable anesthetics.



WARNING

Use of accessories or cables other than those specified may result in degraded electromagnetic compatibility performance of this device.

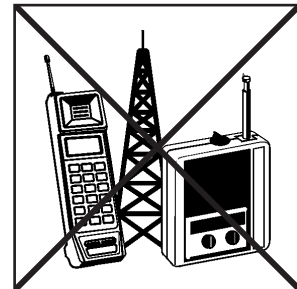

Controls and Indicators

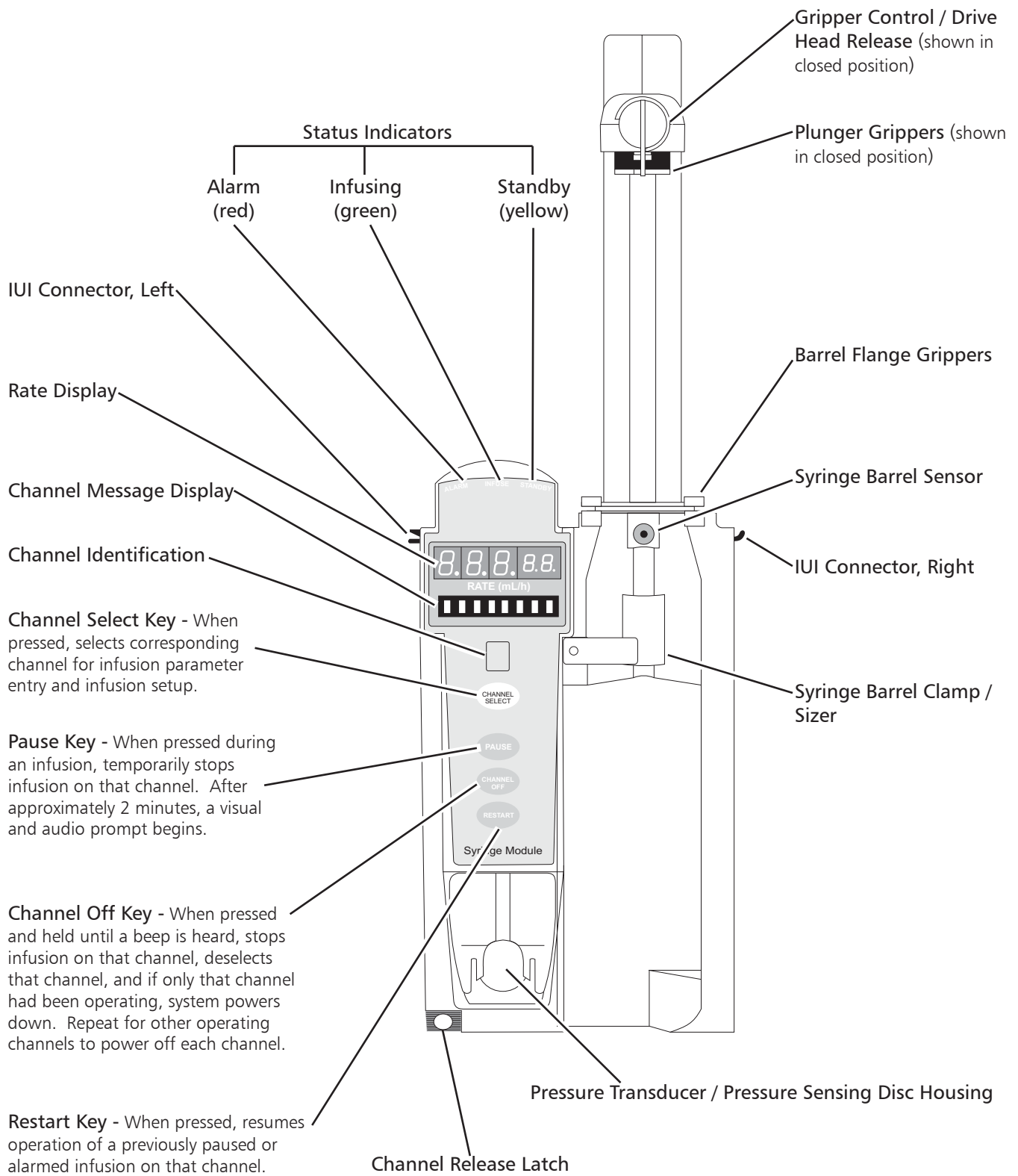

Installation

Instruments are tested and calibrated before they are packaged for shipment. To ensure proper operation after shipment, it is recommended that an incoming inspection be performed before placing the instrument into use.

Unpacking Syringe Module

1. Remove Syringe Module from its carton.
2. Verify gripper control/drive head release, plunger grippers, and syringe barrel clamp/sizer operate freely and correctly.
3. Verify pressure transducer membrane covering is not cut or torn.
4. Verify control surface and instrument housing is not damaged.
5. Check for loose parts.
6. Perform Periodic Inspections (see "Inspection Requirements" section in "Maintenance" chapter).
7. Perform check-in procedure [reference Medley™ Maintenance Software User Manual (included with 8970C, or later) for details].

If the Syringe Module is damaged, contact ALARIS Medical Systems for authorization to return the instrument for repair.

Attaching and Detaching Channels

Refer to the Medley™ Programming Module Directions for Use.

Displays

The displays illustrated throughout this document are for illustration purposes only. The display content will vary, depending on configuration settings, type of syringe and administration set in use, hospital-defined data set uploaded using the Guardrails® Safety Software, programmed drug calculation parameters, and many other variables.

Main Display

Title Bar

Channel Status

- A solid channel letter display indicates channel is operating.
- An outlined channel letter display indicates channel is attached and ready for use.

Soft Keys

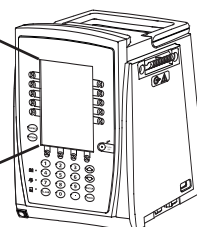
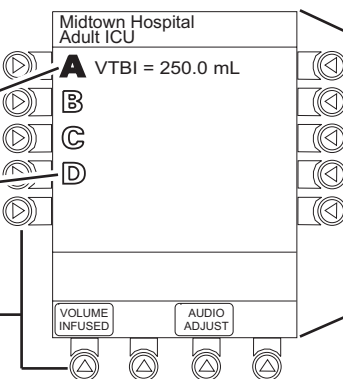

Channel Selected Indicator

"Inactive" Soft Key

Nonhighlighted indicates a nonselected soft key.

"Active" Soft Key

Highlighted indicates a selected soft key.

Prompt Bar

Look here for user prompts.

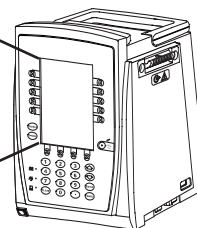
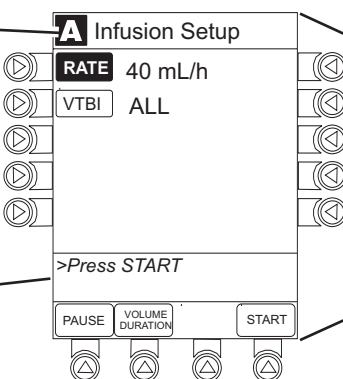

Displays (Continued)

Dynamic Pressure Display

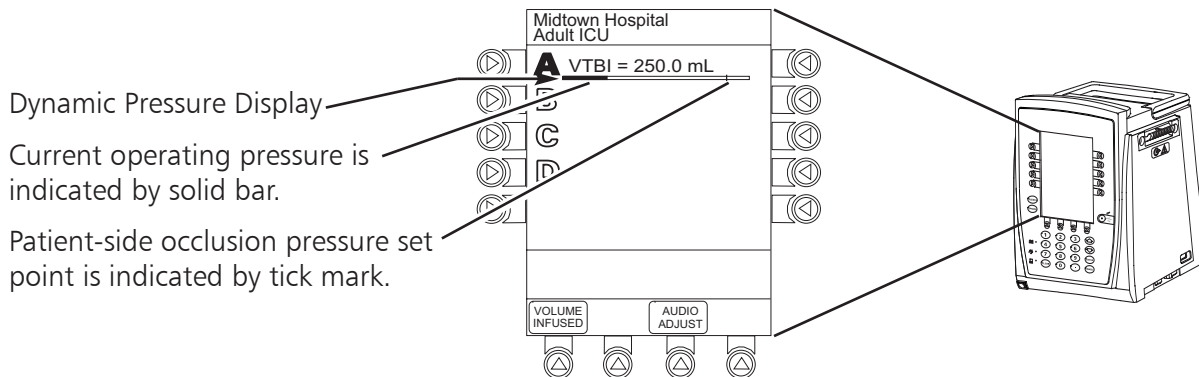

CAUTION

Although the dynamic pressure display bars for the Medley™ Syringe Module and Pump Module both use the full width of the screen for display, they each represent different ranges. The Syringe Module's range is 0 mmHg to 1000 mmHg.

Start-Up

Refer to the Medley™ Programming Module Directions for Use for the following procedures:

- Powering On System
- Responding to Maintenance Reminder
- Selecting New Patient and Profile Options
- Entering Patient ID
- Modifying Patient ID

Preparing Infusion

Preparing Syringe and Administration Set

1. Prepare syringe (reference “Compatible Syringes” section in “Maintenance” chapter) in accordance with manufacturer’s directions for use.
2. Prepare administration set (reference Set Compatibility Card, provided separately) in accordance with manufacturer’s directions for use.
3. Attach upper fitting of administration set to syringe tip.

WARNING

Use only standard, single-use, disposable syringes (with luer-lock connectors) and administration sets, designed for use on syringe pumps. The use of any other syringe or administration set may cause improper instrument operation, resulting in inaccurate fluid delivery or pressure sensing, or other potential hazards. For a list of compatible syringes, refer to the “Compatible Syringes” section in the “Maintenance” chapter. For a list of compatible administration sets, refer to the Set Compatibility Card (provided separately).

Loading Syringe and Administration Set

WARNINGS

- Before loading the syringe, check it for damage or defects.
- Ensure syringe barrel, flange, and plunger are installed and secured correctly. Failure to install syringe correctly can result in uncontrolled fluid flow to the patient, and may cause serious injury or death.
- Before loading or unloading the syringe, always turn off fluid flow to the patient, using the tubing clamp or stopcock. Uncontrolled fluid flow can occur when the administration set is not clamped or turned off, and may cause serious injury or death.

CAUTION

When initially loading the syringe, allow for the volume of fluid contained in the administration set and retained in the syringe at the end of an infusion, as this “dead space” will not be infused.

Preparing Infusion (Continued)

Loading Syringe and Administration Set (Continued)

1. Open syringe barrel clamp.
 - a. Pull syringe barrel clamp out and hold.
 - b. Rotate clamp to left (clockwise or counter clockwise) until it clears syringe chamber.
 - c. Gently release clamp.

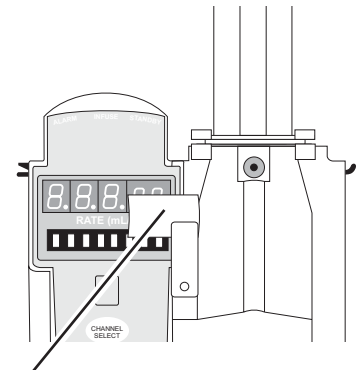

Syringe Barrel Clamp Open

2. Raise drive head to its fully extended position.
 - a. Twist gripper control clockwise and hold in position.

NOTE: The gripper control is spring loaded. When twisted to the open position and then released, it (and the plunger grippers) will return to the closed position.

- b. While holding gripper control in open position, raise drive head to full extension.
 - c. Gently release gripper control.

Drive Head Fully Extended

Gripper Control / Drive Head Release in Open Position

Plunger Grippers Open

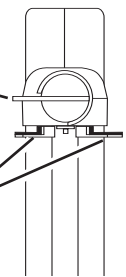

3. Insert syringe (from front of instrument) by sliding flat edge of syringe barrel flange between barrel flange grippers.

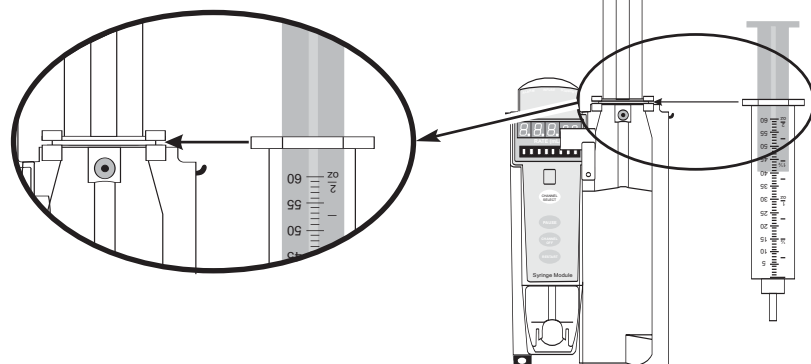

Preparing Infusion (Continued)

Loading Syringe and Administration Set (Continued)

4. Lock syringe in place.
 - a. Pull syringe barrel clamp out and hold.
 - b. Rotate clamp to right (clockwise or counter clockwise) until it lines up with syringe.
 - c. Gently release clamp against syringe.

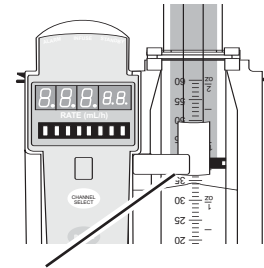

Syringe Barrel Clamp Closed

5. Lower drive head and lock plunger in place with plunger grippers.
 - a. Twist gripper control clockwise and hold in position.

NOTE: The gripper control is spring loaded. When twisted to the open position and then released, it (and the plunger grippers) will return to the closed position.
 - b. While holding gripper control in open position, gently lower drive head until it makes contact with plunger flange.
 - c. Gently release gripper control.
 - d. Ensure plunger grippers lock and hold plunger in place.

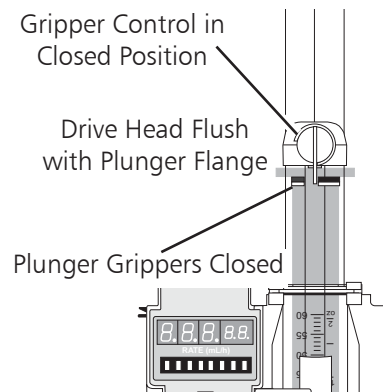

CAUTIONS

- To avoid an occlusion when loading a smaller size syringe, use extra care to close off administration set tubing and gently lower drive head against syringe plunger.
- For smaller syringes (such as; 1, 3, or 5 cc), stabilize the syringe plunger with thumb and index finger while carefully lowering the drive head. Ensure the syringe plunger head makes contact with the small black sensor, located on the bottom of the drive head (between the plunger grippers).

Preparing Infusion (Continued)

Loading Syringe and Administration Set (Continued)

6. Insert pressure sensing disc (if used), as follows:

NOTE: The following are special Syringe Module features available only with extension sets fitted with a pressure sensing disc: (Refer to the "Features and Definitions" section in the "Introduction" chapter for definitions.)

Auto Pressure

Back Off (Upon Occlusion)

Customizable Pressure Alarm Settings (see "Occlusion Pressure" feature definition)

Dynamic Pressure Display (see "Pressure Tracking" feature definition)

Fast Start

- a. Orient pressure sensing disc, as follows:
- fluid side up (patient side down)
 - cavity forward (membrane toward instrument)
- b. Gently slide pressure sensing disc up into slot in pressure sensing disc housing.
- c. Apply firm upward pressure on pressure sensing disc (not tubing) until disc snaps into place.

WARNING

When the pressure sensing disc is not being used and an occlusion occurs, there is a risk of infusing pressurized buildup of infusates upon correction of the occlusion. To avoid an inadvertent bolus, relieve the pressure before restarting the infusion.

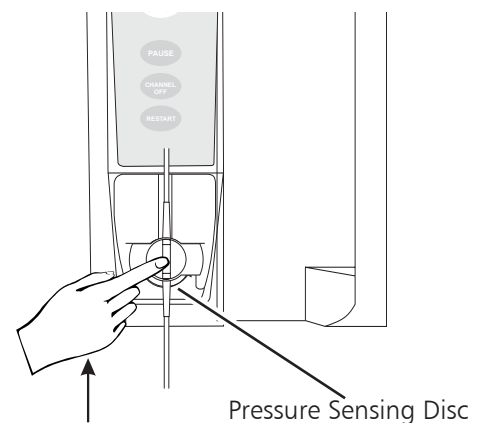
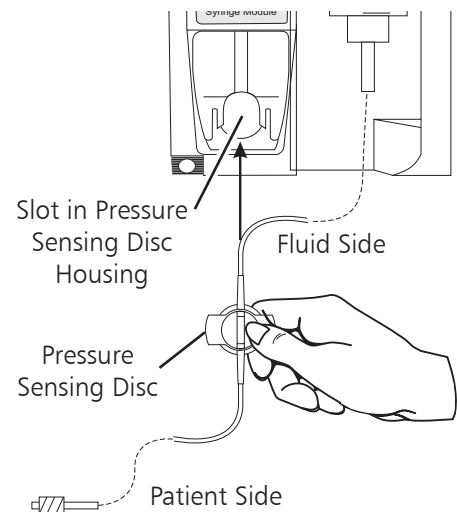

Preparing Infusion (Continued)

Selecting Syringe Type and Size

At the start of an infusion program, the system prompts to select and confirm the syringe type and size.

NOTE: The system automatically detects the syringe size, and lists syringe types and sizes that most closely match the installed syringe. If the syringe is not recognized, "Syringe not recognized" displays. Use a syringe that is recognized and accepted by the system.

WARNING

Ensure the displayed syringe manufacturer and size correctly identifies the installed syringe. Mismatches may cause an under-infusion or over-infusion to the patient that could result in serious injury and/or death. For a list of compatible syringes, refer to the "Compatible Syringes" section in the "Maintenance" chapter. If the installed syringe is displayed and selected, but is not recognized, servicing is required (refer to "Service Information" section in "Maintenance" chapter).

1. Press CHANNEL SELECT key.

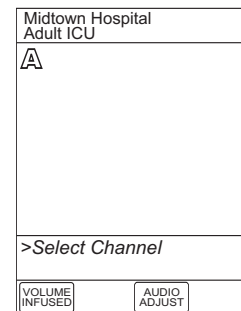

2. Press soft key next to installed syringe type and size.
 - Selection is highlighted.

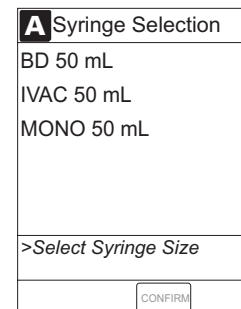

Preparing Infusion (Continued)

Selecting Syringe Type and Size (Continued)

3. To accept, press **CONFIRM** soft key.

A Syringe Selection
BD 50 mL
IVAC 50 mL
MONO 50 mL
>Confirm Syringe Size
CONFIRM

4. Press soft key next to applicable infusion type, **Basic Infusion** or **Guardrails Drug Library**.

NOTE: The **RESTORE** soft key appears only if there had been a previous infusion programmed for the same patient.

A Infusion Menu
Guardrails Drug Library
Basic infusion
>Select an Option or EXIT
RESTORE EXIT

- If **Basic Infusion** was selected, **Infusion Setup** screen displays and title alternates between **Infusion Setup** and identifying syringe model and size.

A Infusion Setup
RATE ___ mL/h
VTBI ALL
>Select RATE
VOLUME DURATION

- If **Guardrails Drug Library** was selected, **Guardrails Drug Library** screen displays.

A Guardrails Drug Library	Adult ICU
Aminophylline 50mg/50mL	A-E
Bretylium 50 mg/25mL	F-J
Dobutamine ___mg/___mL	K-O
Dopamine 40mg/50mL	P-T
Dopamine 8mg/25mL	U-Z
>Select Drug/Concentration	
EXIT	DRUG CALC PAGE DOWN

Preparing Infusion (Continued)

Priming

The Priming option can be enabled at the time the Medley™ System is configured for use. The Priming selection (**PRIME** soft key) is available only after the syringe and infusion type have been selected, and prior to beginning an infusion.

If a pressure sensing disc is in use, it must be removed from instrument before priming. Refer to the applicable section, as follows, depending on whether or not a pressure sensing disc is used.

NOTE: When manually priming (per hospital protocol) and an administration set having a pressure sensing disc is in use, depress the disc between two fingers while priming and prime uphill (distal end of pressure sensing disc/tubing pointing upward).

Pressure Sensing Disc Used/Installed

1. Remove pressure sensing disc from instrument.
 - Using a finger, apply firm downward pressure on pressure sensing disc (not tubing) until disc snaps loose from slot in pressure sensing disc housing.

WARNING

When priming:

- Ensure patient is not connected.
- Ensure air is expelled from line prior to beginning infusion (unexpelled air in line could have serious consequences).

Failure to prime correctly can delay infusion delivery and cause the total volume to be infused to read higher than the actual total delivered to the patient.

CAUTION

During priming, the pressure limit alarms are temporarily increased to their maximum level.

CAUTION

The pressure sensing disc, if left installed during priming, can trap air that may not be totally expelled. To ensure entrapped air is eliminated, it is recommended that the pressure sensing disc be removed prior to priming and the membrane massaged with a finger while priming. After priming is completed, reinstall the pressure sensing disc.

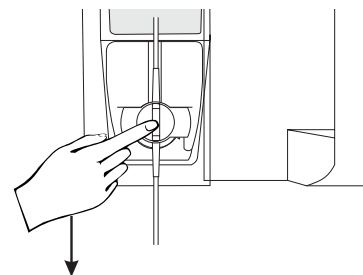

Preparing Infusion (Continued)

Priming (Continued)

- Press **OPTIONS** key.
- Press **Prime Set with Syringe** soft key.

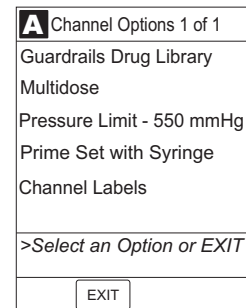

- If pressure sensing disc was not removed prior to pressing **Prime Set with Syringe** soft key, a pressure sensing disc removal prompt displays.

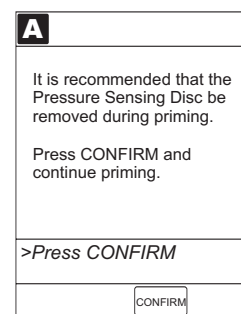

- Prime, as follows:
 - Orient pressure sensing disc with patient side up.
 - Depress and hold pressure sensing disc between two fingers.

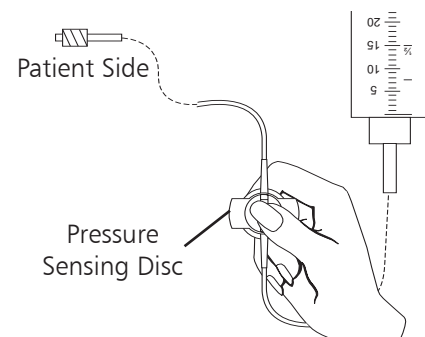

- Press and hold **PRIME** soft key until fluid flows and priming of syringe administration set is complete.
- Release pressure sensing disc.

NOTE: Fluid is delivered during priming only while the **PRIME** soft key is pressed. Each press of the **PRIME** soft key delivers up to 2 mL of priming fluid per continuous press. To deliver additional amounts, press the **PRIME** soft key again.

- Volume used during priming is displayed but not added to VTBI.

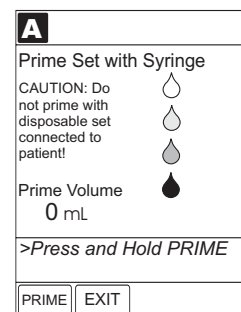

Preparing Infusion (Continued)

Priming (Continued)

Pressure Sensing Disc Used/Installed (Continued)

5. When priming is complete, release **PRIME** soft key.

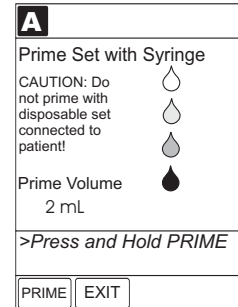

6. Reinstall pressure sensing disc, as follows:
- Orient pressure sensing disc, as follows:
 - fluid side up (patient side down)
 - cavity forward (membrane toward instrument)
 - Gently slide pressure sensing disc up into slot in pressure sensing disc housing.

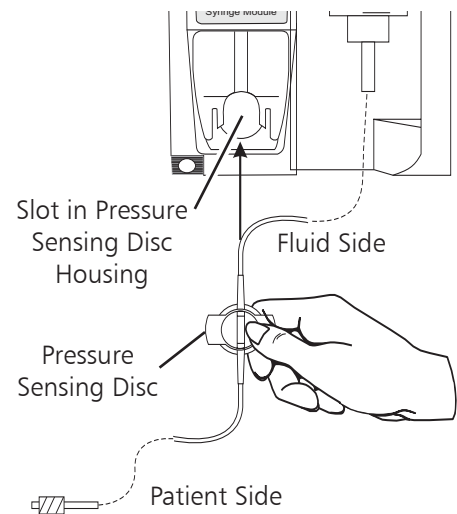

- Apply firm upward pressure on pressure sensing disc (not tubing) until disc snaps into place.

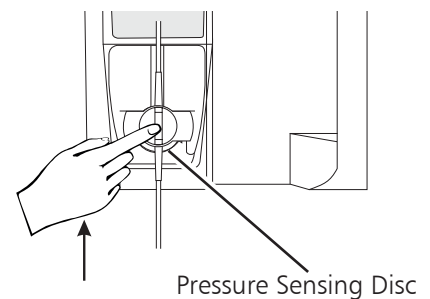

Preparing Infusion (Continued)

Priming (Continued)

Pressure Sensing Disc Used/Installed (Continued)

- To return to main screen, press **EXIT** soft key.
 - If **EXIT** soft key is pressed before pressure sensing disc is reinstalled, a prompt to reinstall pressure sensing disc displays.
 - If **Basic Infusion** was selected, **Infusion Setup** screen displays and title alternates between **Infusion Setup** and identifying syringe model and size.
 - If **Guardrails Drug Library** was selected, **Guardrails Drug Library** screen displays.

A

Re-install Pressure Sensing Disc.

>Press CONFIRM

CONFIRM

A Infusion Setup

RATE ___ mL/h

VTBI ALL

>Select RATE

VOLUME DURATION

A Guardrails Drug Library
Adult ICU

Aminophylline 50mg/50mL	A-E
Bretylum 50 mg/25mL	F-J
Dobutamine ___mg/___mL	K-O
Dopamine 40mg/50mL	P-T
Dopamine 8mg/25mL	U-Z

>Select Drug/Concentration

EXIT DRUG CALC PAGE DOWN

Pressure Sensing Disc Not Used/Installed

- Press **OPTIONS** key.
- Press **Prime Set with Syringe** soft key.

A Channel Options 1 of 1

Guardrails Drug Library

Multidose

Pressure Limit - High

Prime Set with Syringe

Channel Labels

>Select an Option or EXIT

EXIT

Preparing Infusion (Continued)



Priming (Continued)

Pressure Sensing Disc Not Used/Installed (Continued)



- Press and hold **PRIME** soft key until fluid flows and priming of syringe administration set is complete.

NOTE: Fluid is delivered during priming only while the **PRIME** soft key is pressed. Each press of the **PRIME** soft key delivers up to 2 mL of priming fluid per continuous press. To deliver additional amounts, press the **PRIME** soft key again.

- Volume used during priming is displayed but not added to VTBI.

A	
Prime Set with Syringe	
CAUTION: Do not prime with disposable set connected to patient!	
Prime Volume	
0 mL	
>Press and Hold PRIME	
PRIME	EXIT

- When priming is complete, release **PRIME** soft key.
- To return to main screen, press **EXIT** soft key.

A	
Prime Set with Syringe	
CAUTION: Do not prime with disposable set connected to patient!	
Prime Volume	
2 mL	
>Press and Hold PRIME	
PRIME	EXIT

- If **Basic Infusion** was selected, **Infusion Setup** screen displays and title alternates between **Infusion Setup** and identifying syringe model and size.

A Infusion Setup	
RATE	___ mL/h
VTBI	ALL
>Select RATE	
VOLUME DURATION	

- If **Guardrails Drug Library** was selected, **Guardrails Drug Library** screen displays.

A Guardrails Drug Library Adult ICU	
Aminophylline 50mg/50mL	A-E
Bretylium 50 mg/25mL	F-J
Dobutamine ___mg/___mL	K-O
Dopamine 40mg/50mL	P-T
Dopamine 8mg/25mL	U-Z
>Select Drug/Concentration	
EXIT	DRUG CALC
	PAGE DOWN

Basic Infusion

The following procedures should be used only when programming a **Basic Infusion**. To program an infusion using the Guardrails® Drug Library, go to the “Setting Up Drug Calculation” section.

NOTES:

The illustrations in this section assume the following:

- *ALL Mode, Drug Calculation, Dynamic Pressure Display, Profiles, and Volume Duration configurable settings are enabled.*
- *Delay Options and NEOI configurable settings are disabled.*

*If Delay Options is enabled, the **PAUSE** soft key becomes **DELAY OPTIONS**.*

1. Perform steps in “Start-Up” section, to:
 - a. Power on system.
 - b. Choose **Yes** or **No** to **New Patient?**
 - c. Confirm current profile or select a new profile.
 - d. Enter patient identifier, if required.
2. Perform steps in “Preparing Infusion” section, to:
 - a. Prepare syringe and administration set.
 - b. Load syringe and administration set.
 - c. Select syringe type and size, and **Basic Infusion** as infusion type.
 - d. Prime.
3. Start an infusion, as described in following “Starting Rate / Volume Infusion” or “Starting Volume / Duration Infusion” section.

WARNING

When the pressure sensing disc is not being used and an occlusion occurs, there is a risk of infusing pressurized buildup of infusates upon correction of the occlusion. To avoid an inadvertent bolus, relieve the pressure before restarting the infusion.

Basic Infusion (Continued)

Starting Rate / Volume Infusion

1. To enter flow rate, press **RATE** soft key and use numeric data entry keys.

The screen displays 'A Infusion Setup'. At the top, there is a 'RATE' field with four dashes and 'mL/h' to its right. Below it is a 'VTBI' field with 'ALL' to its right. At the bottom, there is a 'VOLUME DURATION' field. A soft key '>Select RATE' is located at the bottom of the screen.

2. To enter a numeric **VTBI** value (instead of infusing **ALL**), press **VTBI** soft key and use numeric data entry keys.

OR

To deliver entire contents of syringe, leave **VTBI** as **ALL**.

NOTE: When **ALL MODE** is disabled, the **VTBI ALL** option is not available.

3. Attach administration set to patient's vascular access device.
4. Verify correct infusion parameter entry and press **START** soft key.

The screen displays 'A Infusion Setup'. The 'RATE' field now shows '40 mL/h'. The 'VTBI' field still shows 'ALL'. At the bottom, there are three soft keys: 'PAUSE', 'VOLUME DURATION', and 'START'. A soft key '>Press START' is located above the 'START' key.

NOTE: The infusion may be paused by pressing the **PAUSE** soft key. Refer to "Pausing Infusion" section.

- During infusion:
 - ◆ Green Infusing Status Indicator illuminates.
 - ◆ Rate appears in Channel Rate Display.
 - ◆ Remaining VTBI appears on Main Display.
 - ◆ When infusion is close to being completed and NEOI is enabled:
 - Main Display alternates between **NEAR END** and remaining VTBI.
 - NEAR END** scrolls in Channel Message Display.
 - Yellow Standby Indicator flashes.
 - An audio prompt sounds.

The screen displays 'Midtown Hospital Adult ICU'. Below that, it shows 'A VTBI = ALL (50 mL)'. At the bottom, there are two soft keys: 'VOLUME INFUSED' and 'AUDIO ADJUST'.

-- Continued on Next Page --

Basic Infusion (Continued)

Starting Rate / Volume Infusion (Continued)

- At completion of infusion:
 - ◆ An audio prompt sounds.
 - ◆ Red Alarm Status Indicator flashes.
 - ◆ If KVO option is enabled:
 - Channel Rate Display changes to KVO rate.
 - INFUSION COMPLETE–KVO** scrolls in Channel Message Display.
 - KVO** followed by **SYRINGE EMPTY** appears on Main Display.
 - ◆ If KVO option is disabled, and:
 - Syringe is not empty: **INFUSION COMPLETE** scrolls in Channel Message Display and **COMPLETE** appears on Main Display.
 - Syringe is empty: **SYRINGE EMPTY** scrolls in Channel Message Display and appears on Main Display.

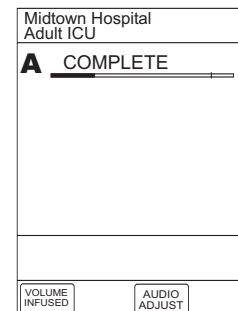
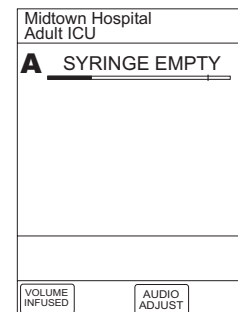
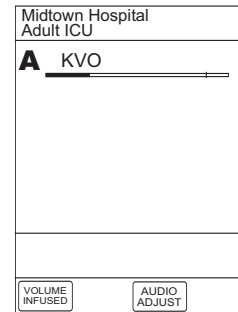

Starting Volume / Duration Infusion

1. Press **VOLUME DURATION** soft key.

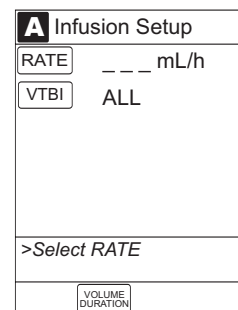

Basic Infusion (Continued)

Starting Volume / Duration Infusion (Continued)

- To enter a numeric **VTBI** value (instead of infusing **ALL**), press **VTBI** soft key and use numeric data entry keys.

OR

To deliver entire contents of syringe, leave **VTBI** as **ALL**.

NOTE: When **ALL MODE** is disabled, the **VTBI ALL** option is not available.

- To enter volume duration, press **DURATION** soft key and use numeric data entry keys.
 - Rate is automatically calculated.
- Attach administration set to patient's vascular access device.

A Infusion Setup	
RATE=	___ mL/h
VTBI	ALL
DURATION	__ h __ mm
>Select DURATION	
RATE VOLUME	

- Verify correct infusion parameter entry and press **START** soft key.

- During infusion:
 - Green Infusing Status Indicator illuminates.
 - Rate appears in Channel Rate Display.
 - VTBI counts down on Main Display.
 - When infusion is close to being completed and **NEOI** is enabled:

Main Display alternates between **NEAR END** and remaining VTBI.

NEAR END scrolls in Channel Message Display.

Yellow Standby Indicator flashes.

An audio prompt sounds.

A IVAC 50 mL		
RATE=	50 mL/h	
VTBI	ALL	
DURATION	1:00 hh:mm	
>Press START		
PAUSE	RATE VOLUME	START

Midtown Hospital Adult ICU	
A <u>VTBI = ALL (50 mL)</u>	
>Press START	
VOLUME INFUSED	AUDIO ADJUST

NOTE: To view infusion **Time Left**, press **CHANNEL SELECT** key. To return to previous screen, press **START** soft key.

A Infusion Setup		
RATE	50 mL/h	
VTBI	ALL	
Time Left: 00 h 45 min		
>Press START		
PAUSE	VOLUME DURATION	START

-- Continued on Next Page --

Basic Infusion (Continued)

Starting Volume / Duration Infusion (Continued)

- At completion of infusion:
 - An audio prompt sounds.
 - Red Alarm Status Indicator flashes.
 - If KVO option is enabled:
 - Rate Display changes to KVO rate.
 - INFUSION COMPLETE–KVO** scrolls in Channel Message Display.
 - KVO** followed by **SYRINGE EMPTY** appears on Main Display.
 - If KVO option is disabled, and:
 - Syringe is not empty: **INFUSION COMPLETE** scrolls in Channel Message Display and **COMPLETE** appears on Main Display.
 - Syringe is empty: **SYRINGE EMPTY** scrolls in Channel Message Display and appears on Main Display.

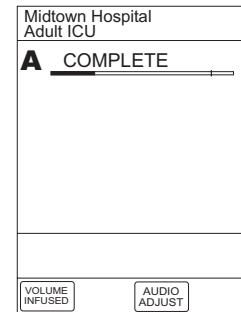

Possible End of Infusion Messages and Alerts

KVO	VTBI	Delayed	Programming Module Display	Channel Display	Audio / Visual Alert
N/A	All	Yes	Syringe Empty	Syringe Empty	Yes / Yes
On	All	No	Syringe Empty	Syringe Empty	Yes / Yes
Off	All	No	Syringe Empty	Syringe Empty	Yes / Yes
N/A	Numeric	Yes	Complete	Infusion Complete	Yes / Yes (if an After callback is scheduled)
N/A	Numeric	Yes	Syringe Empty	Syringe Empty	Yes / Yes
Off	Numeric	No	Complete	Infusion Complete	Yes / Yes
Off	Numeric	No	Syringe Empty	Syringe Empty	Yes / Yes
On	Numeric	No	Syringe Empty	Syringe Empty	Yes / Yes

Basic Infusion (Continued)

Pausing Infusion

NOTE: To pause an infusion when *Delay Options* is enabled, reference “*Delay Options*”, “*Pausing Infusion*” section.

1. Press **PAUSE** key (on Syringe Module).

OR

Press **CHANNEL SELECT** key and then press **PAUSE** soft key (on Programming Module).

- **PAUSE** scrolls in Channel Message Display.
- **PAUSED** appears on Main Display.
- Yellow Standby Status Indicator illuminates.
- After two minutes, “**PAUSE-RESTART CHANNEL**” visual and audio prompts begin, and yellow Standby Status Indicator flashes.

A IVAC 50 mL		
RATE 50 mL/h		
VTBI ALL		
>Press START		
PAUSE	VOLUME DURATION	START

2. To reinitiate infusion:

- Press **RESTART** key (on Syringe Module).

OR

- Press **CHANNEL SELECT** key and then press **START** soft key (on Programming Module).

Midtown Hospital Adult ICU	
A PAUSED	
VOLUME INFUSED	AUDIO ADJUST

A IVAC 50 mL		
RATE 50 mL/h		
VTBI ALL		
>Press START		
PAUSE	VOLUME DURATION	START

Basic Infusion (Continued)

Restarting Infusion Following Infusion Complete

1. If syringe requires replacement, reference “Preparing Infusion” section to:
 - a. Remove existing syringe and prepare new syringe (reference “Preparing Syringe and Administration Set” section).
 - b. Load syringe and administration set.
 - c. Select syringe type and size.

NOTE: Since the system is already in a basic infusion mode, the Infusion Menu screen does not appear after the syringe type and size are confirmed.

- d. Prime.

2. To restart infusion using stored parameters, press **RESTORE** soft key and continue with next step.

OR

To start a new infusion, follow steps for “Starting Rate / Volume Infusion” or “Starting Volume / Duration Infusion”.

A Infusion Setup	
RATE	___ mL/h
VTBI	ALL
>Select Rate or Restore Previous Infusion	
RESTORE	VOLUME DURATION

3. Verify parameters are valid and press **START** soft key.

NOTE: To change a restored parameter:

- a. Press applicable soft key, **VTBI** or **RATE**.
- b. Enter desired parameter using Up/Down Arrows for rate titration, or numeric data entry keys.
- c. Press **START** soft key.

A IVAC 50 mL		
RATE	50 mL/h	
VTBI	ALL	
>Press START		
PAUSE	VOLUME DURATION	START

Basic Infusion (Continued)

Changing Rate or VTBI During Infusion

1. Press **CHANNEL SELECT** key.
2. Press either **RATE** or **VTBI** soft key.

A	Infusion Setup	
RATE	50 mL/h	
VTBI	40 mL	
>Press START		
PAUSE	VOLUME DURATION	START

3. To enter desired parameter, use Up/Down Arrows for rate titration, or numeric data entry keys.
4. Verify correct infusion parameter entry and press **START** soft key.

A	Infusion Setup	
RATE	_60 mL/h	
VTBI	40 mL	
>Press START		
PAUSE	VOLUME DURATION	START

Stopping Infusion

Press and hold **CHANNEL OFF** key until a beep is heard (approximately 1.5 seconds) and then release to initiate power down.

NOTES:

- If no other channel is active, the system powers down when the **CHANNEL OFF** key is released.
- To interrupt the power down sequence, quickly press any one of the numeric keys on the Programming Module.

Selecting Pressure Limit

Pressure Sensing Disc Installed

1. Ensure pressure sensing disc is installed correctly.
2. Press **CHANNEL SELECT** key.
3. Press **OPTIONS** key.

WARNING

Installing a pressure sensing disc after an infusion has started can result in a bolus to the patient.

Basic Infusion (Continued)

Selecting Pressure Limit (Continued)

Pressure Sensing Disc Installed (Continued)

4. Press **Pressure Limit** soft key.

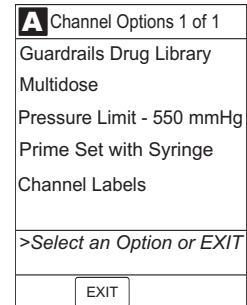

5. To enter a new pressure limit value, press **Change Value** soft key.

OR

If Auto Pressure feature is enabled, press **Auto Pressure** soft key.

NOTE: If Auto Pressure is selected and current pressure is:

- 100 mmHg or less – system adds 30 mmHg to current pressure, to create a new alarm limit
- greater than 100 mmHg – system adds 30% to current pressure, to create a new alarm limit

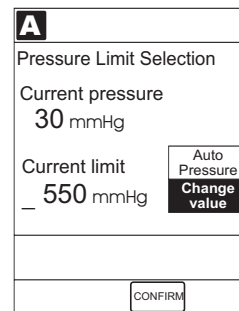

6. Verify correct pressure limit input and press **CONFIRM** soft key.

Pressure Sensing Disc Not Installed

1. Press **CHANNEL SELECT** key.
2. Press **OPTIONS** key.
3. Press **Pressure Limit** soft key.

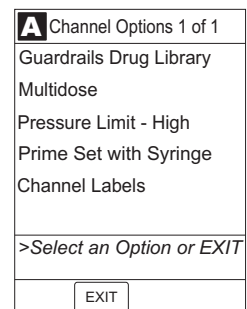

Basic Infusion (Continued)

Selecting Pressure Limit (Continued)

Pressure Sensing Disc Not Installed (Continued)

- To select a pressure limit, press appropriate soft key (**Low**, **Med**, or **High**).
- Press **CONFIRM** soft key.

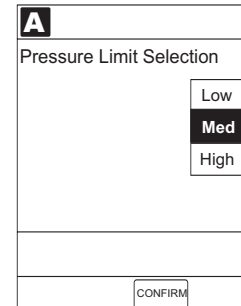

Viewing and Clearing Volume Infused

- To view volume infused, press **VOLUME INFUSED** soft key.
 - Total volume infused, and time and date volume infused was last cleared, display for each channel.

NOTES:

- Date format is year-month-day.
- If a Pump Module is attached, a **PRI/SEC VOLUME** soft key is available to allow secondary volume infused to be displayed.
- If no key is pressed, main screen appears after 30 seconds.

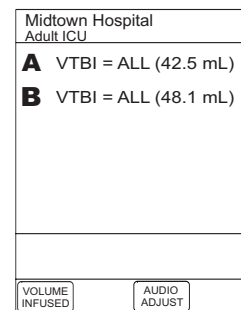

- To clear volume infused:

NOTE: If no key is pressed, main screen appears after 30 seconds.

- If only selected channels are to be cleared, press soft key next to applicable channel(s) and press **CLEAR CHANNEL** soft key.
 - Volume clears on selected channel(s).
- If all channels are to be cleared, press **CLEAR ALL** soft key.
- To return to main screen, press **MAIN SCREEN** soft key.

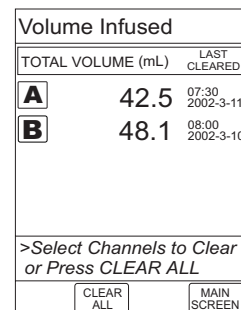

Basic Infusion (Continued)

Changing Syringe During Infusion

1. To stop infusion, press **PAUSE** key (on Syringe Module).
2. Open plunger grippers and syringe barrel clamp.
 - An audio prompt sounds (to silence, press **SILENCE** key).
 - Red Alarm Status Indicator flashes.
 - **CHECK SYRINGE** scrolls in Channel Message Display.
3. Remove syringe and separate administration set from syringe.
4. Reattach administration set to new syringe (refer to “Preparing Infusion” section).
5. Load new syringe (refer to “Preparing Infusion” section).
6. Select syringe type and size (refer to “Preparing Infusion” section).
7. Press **CONFIRM** soft key.
8. Prime administration set (refer to “Preparing Infusion” section).
9. Press **RESTORE** soft key.

OR

To enter VTBI and rate, press **RATE** soft key and use numeric data entry keys, and then **VTBI** soft key and use numeric data entry keys.

10. To begin infusion, press **START** soft key.

Channel Labels

Selecting Channel Label

1. Press **CHANNEL SELECT** key.
2. Press **OPTIONS** key.
3. Press **Channel Labels** soft key.

A Channel Options 1 of 1
Guardrails Drug Library
Multidose
Pressure Limit - High
Prime Set with Syringe
Channel Labels
>Select an Option or EXIT
EXIT

4. Press soft key for desired label.

NOTE: To view additional labels, press a soft key next to a letter group to navigate through alphabet, and/or **PAGE UP** and **PAGE DOWN** soft keys.

- Selected label is highlighted and scrolls in Channel Message Display.

A Channel Label Display Adult ICU	
0.9% NaCl	A-E
3% NaCl	F-J
CVVHDF Dialysate	K-O
D5 1/2 NS	P-T
Epidural	U-Z
>Select Channel Label	
EXIT	PAGE DOWN

A Channel Label Display Adult ICU		
Peripheral Art Line	P	
Replacement Solution	Q	
Swan	R	
Triple Lumen	S	
	T	
>Select Channel Label		
PAGE UP	BACK	PAGE DOWN

5. To continue infusion, press **START** soft key.

OR

Program infusion as previously described.

A Infusion Setup		
RATE	50 mL/h	
VTBI	40 mL	
>Press START		
PAUSE	VOLUME DURATION	START

Channel Labels (Continued)

Removing Channel Label

1. Press **CHANNEL SELECT** key.
2. Press **OPTIONS** key.
3. Press **Channel Labels** soft key.

A Channel Options 1 of 1
Guardrails Drug Library
Multidose
Pressure Limit - High
Prime Set with Syringe
Channel Labels
>Select an Option or EXIT
EXIT

4. Press **CLEAR LABEL** soft key.
 - Label stops scrolling in Channel Message Display.

A Channel Label Display	
Adult ICU	
0.9% NaCl	A-E
3% NaCl	F-J
CVVHDF Dialysate	K-O
D5 1/2 NS	P-T
Epidural	U-Z
>Select Channel Label	
EXIT CLEAR LABEL PAGE DOWN	

5. To begin infusion, press **START** soft key.
OR
Program infusion as previously described.

A IVAC 50 mL	
RATE	50 mL/h
VTBI	ALL
>Press START	
PAUSE VOLUME DURATION START	

Powering Off

Refer to the Medley™ Programming Module Directions for Use to the following procedures:

Powering Off System
Powering Off Channel

Setting Up Drug Calculation

The drug calculation can be set up for a drug stored in the Guardrails® Drug Library or for a non-library drug, as described in the following sections. To access the drug library, a hospital-defined best-practice data set must be uploaded, using the Guardrails® Safety Software, and the Profiles feature must be enabled.

Drug Calculation Parameters

The Medley™ System uses the following parameters, entered during the drug calculation setup procedure:

- **Bolus dose duration:** Time period over which bolus dose is to be administered.
- **Bolus dose units:** Units used in calculating bolus dose. Bolus dose units are selected from alternatives provided.
- **Diluent volume:** Volume of fluid used as diluent for drug (mL).
- **Dosing units:** Units used to calculate continuous infusion drug dose. Dosing Units are selected from alternatives provided.
- **Drug amount:** Amount of drug in IV container (gram, mg, mcg, mEq, or units).
- **Patient weight:** Weight of patient (kg); this is an optional parameter that is not needed unless drug dose is normalized for patient weight.
- **Time units:** Time base for all calculations (minute, hour, or day).

The bolus dose, drug dose, and flow rate parameters are calculated using the above parameters, as follows:

- Bolus dose = Bolus dose x Patient weight (if used).
- Bolus dose administration rate (**INFUSE AT:**):
When duration is entered = total dose / duration in minutes.
When Max Rate is used = Max Rate / 60 x concentration.
- Bolus dose duration = Bolus VTBI / Bolus rate.
- Bolus dose VTBI = Bolus dose / Drug concentration.
- Bolus rate = Bolus VTBI / Duration.

-- Continued on Next Page --

WARNINGS

- The Drug Calculation feature is to be used only by personnel properly trained in the administration of continuously infused medications. Extreme caution should be exercised to ensure the correct entry of the drug calculation infusion parameters.
- References in this document to specific drugs and drug doses are for illustration purposes only. Refer to specific drug product labeling for information concerning appropriate administration techniques and dosages.

Setting Up Drug Calculation (Continued)

Drug Calculation Parameters (Continued)

- Continuous drug dose = Flow rate x Drug concentration (normalized for patient weight if specified by entering a patient weight).
- Continuous flow rate = Drug dose / Drug concentration (normalized for patient weight if specified by entering a patient weight).
- Drug concentration = Drug amount / Diluent volume.
- Total bolus dose:
Bolus dose not weight-based = bolus dose entered.
Bolus dose weight-based = bolus dose x patient weight.

Using Guardrails® Drug Library

When using a drug listed in the Guardrails® Drug Library, the Guardrails® Software automatically calculates the drug parameters, based on:

- drug selected
 - weight entry (if required)
 - rate or dose entry, and
 - VTBI entry (if other than All)
1. Perform steps in “Start-Up” section, to:
 - a. Power on system.
 - b. Choose **Yes** or **No** to **New Patient?**
 - c. Confirm current profile or select a new profile.
 - d. Enter patient identifier, if required.
 2. Perform steps in “Preparing Infusion” section, to:
 - a. Prepare syringe and administration set.
 - b. Load syringe and administration set.
 - c. Select syringe type and size, and **Guardrails Drug Library** as infusion type.
 - d. Prime.

Setting Up Drug Calculation (Continued)

Using Guardrails® Drug Library (Continued)

3. Press soft key next to desired drug and concentration.

NOTES:

- To view additional drugs/concentrations, press a soft key next to a letter group to navigate through alphabet, and/or **PAGE UP** and **PAGE DOWN** soft keys.
- The facility may choose to to prepopulate standard drug concentrations, or leave an open entry (_ _ / _ _ mL) and allow the clinician to enter the desired concentration.

Guardrails Drug Library Adult ICU	
Aminophylline 50mg/50mL	A-E
Bretylium 50 mg/25mL	F-J
Dobutamine __mg/ __mL	K-O
Dopamine 40mg/50mL	P-T
Dopamine 8mg/25mL	U-Z
>Select Drug/Concentration	
EXIT	DRUG CALC
PAGE DOWN	

4. To continue programming, press **Yes** soft key.

- Bolus dose units appear if Bolus Dose is enabled.

OR

To change selection, press **No** soft key.

Guardrails Drug Library Adult ICU	
Lidocaine	Yes
2 gram/250mL was selected.	No
Is this correct?	
DOSING UNITS mg/min	
BOLUSABLE	
BOLUS DOSING UNITS mg/kg	
>Press Yes or No	

- If **Yes** was selected and facility has defined a Clinical Advisory for that drug, a message appears. To indicate information has been noted and continue programming, press **CONFIRM** soft key.

Guardrails Drug Library Lidocaine	
Clinical Advisory:	
Watch IV site carefully for signs of extravasation.	
>Press CONFIRM	
CONFIRM	

- If **Yes** was selected to continue programming, drug amount and diluent volume (if defined in Guardrails® Drug Library) are automatically entered for selected drug.
- If selected drug had “ _ _ / _ _ mL” concentration, drug amount and diluent volume need to be entered.
- If selected drug is not weight-based, **Not Used** displays in **PATIENT WEIGHT** field (as in illustrated example).

Guardrails Drug Library Lidocaine	
DRUG AMOUNT	1 gram
DILUENT VOLUME	50 mL
PATIENT WEIGHT	Not Used
TIME UNITS	min
DOSING UNITS	mg/min
[Conc]:	20 mg/mL
>Press NEXT to Confirm	
NEXT	

-- Continued on Next Page --

Setting Up Drug Calculation (Continued)

Using Guardrails® Drug Library (Continued)

- If hospital practice guidelines identify selected drug as weight-based, prompt for a patient weight in kilograms appears (as in illustrated example, which reflects use of Heparin in Pediatrics ICU).

NOTE: Once a patient weight is entered, for any module, it is automatically entered for any subsequent weight-based calculation.

A Guardrails Drug Library Heparin	
DRUG AMOUNT	10000 units
DILUENT VOLUME	50 mL
PATIENT WEIGHT	_____ kg
TIME UNITS	hour
DOSING UNITS	units/kg/h
[Conc]:	200 units/mL
>Enter Patient Weight	
NEXT	

- Verify parameters are correct and press **NEXT** soft key to confirm.

NOTE: If the ALL Mode is enabled, **VTBI ALL** displays.

A Guardrails Drug Library Lidocaine	
CONTINUOUS INFUSION	
RATE	_____ mL/h
VTBI	ALL
DOSE	_____ mg/min
[Conc]:	20 mg/mL
>Select Rate or Dose	
SETUP	BOLUS

- To make a rate or dose entry, press applicable soft key, **RATE** or **DOSE**, and use numeric data entry keys (other value is calculated and displayed).

A Guardrails Drug Library Lidocaine	
CONTINUOUS INFUSION	
RATE	_____ mL/h
VTBI	_____ mL
DOSE	_____ mg/min
[Conc]:	20 mg/mL
>Select Rate or Dose	
SETUP	BOLUS

- To enter volume to be infused, press **VTBI** soft key and use numeric data entry keys.

NOTE: The **BOLUS** soft key appears only if Bolus Dose is enabled within the selected profile, the drug is bolusable, and a VTBI is entered.

A Guardrails Drug Library Lidocaine	
CONTINUOUS INFUSION	
RATE	27.0 mL/h
VTBI	_____ mL
DOSE	___9 mg/min
[Conc]:	20 mg/mL
>Select VTBI	
SETUP	BOLUS

-- Continued on Next Page --

Setting Up Drug Calculation (Continued)

Using Guardrails® Drug Library (Continued)

NOTE: When VTBI equals ALL, the **ALL** soft key appears inactive when the **VTBI** soft key is pressed and active when a value is entered.

A Guardrails Drug Library Lidocaine	
CONTINUOUS INFUSION	
RATE	27.0 mL/h
VTBI	ALL ALL
DOSE	9 mg/min
[Conc]: 20 mg/mL	
>Enter VTBI	
PAUSE	SETUP BOLUS START

A Guardrails Drug Library Lidocaine	
CONTINUOUS INFUSION	
RATE	27.0 mL/h
VTBI	_ _ 50 mL ALL
DOSE	9 mg/min
[Conc]: 20 mg/mL	
>Press START	
PAUSE	SETUP BOLUS START

8. Verify parameters are correct and press **START** soft key.

A Guardrails Drug Library Lidocaine	
CONTINUOUS INFUSION	
RATE	27 mL/h
VTBI	50 mL
DOSE	9 mg/min
[Conc]: 20 mg/mL	
>Press START	
PAUSE	SETUP BOLUS START

NOTE: If the programmed continuous dose infusion is outside the Guardrails® Soft Limit for that care area, a prompt appears before programming can continue. If the **Yes** soft key is pressed, programming continues; if the **No** soft key is pressed, the infusion needs to be reprogrammed.

A Guardrails Drug Library Lidocaine	
Dose exceeds Guardrail limit of 8 mg/min. Proceed?	Yes No
>Press Yes or No	

-- Continued on Next Page --

Setting Up Drug Calculation (Continued)

Using Guardrails® Drug Library (Continued)

NOTE: If the programmed continuous dose infusion is outside the Guardrails® Hard Limit for that care area, a prompt appears before programming can continue. The infusion needs to be reprogrammed.

- During infusion:
 - ◆ Green Infusing Status Indicator illuminates.
 - ◆ Rate appears in Channel Rate Display.
 - ◆ Dose and drug name scroll in Channel Message Display.

NOTE: If a dose outside of the Guardrails® Soft Limits has been entered and verified as correct, the Channel Message Display also shows either “LLL” for a low dose or “↑↑↑” for a high dose.

- ◆ Main Display alternates between VTBI and drug name with dose.
- ◆ When infusion is close to being completed and NEOI is enabled:
 - Main Display alternates between **NEAR END** and remaining VTBI.
 - NEAR END** scrolls in Channel Message Display.
 - Yellow Standby Indicator flashes.
 - An audio prompt sounds.
- At completion of infusion:
 - ◆ An audio prompt sounds.
 - ◆ Red Alarm Status Indicator flashes.
 - ◆ If KVO option is enabled:
 - Rate Display changes to KVO rate.
 - INFUSION COMPLETE–KVO** (with drug) name, scrolls in Channel Message Display.
 - KVO** followed by **SYRINGE EMPTY** appears on Main Display.

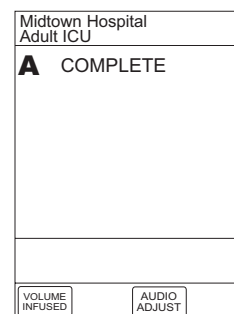
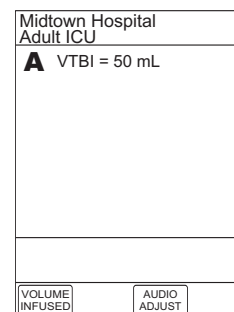
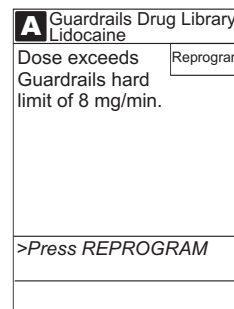

-- Continued on Next Page --

Setting Up Drug Calculation (Continued)

Using Guardrails® Drug Library (Continued)

- ◆ If KVO option is disabled, and:
 - Syringe is not empty: **INFUSION COMPLETE** scrolls in Channel Message Display and **COMPLETE** appears on Main Display.
 - Syringe is empty: **SYRINGE EMPTY** scrolls in Channel Message Display and appears on Main Display.

Using Non-Library Drug

The following procedure should be used only when the drug to be infused is not listed in the Guardrails® Drug Library. When programming a drug not listed in the Guardrails® Drug Library, the drug calculation must be programmed using the **DRUG CALC** soft key within the Guardrails® Drug Library. There are no Guardrails® Limits associated with any non-library drug calculation.

1. Perform steps in "Start-Up" section, to:
 - a. Power on system.
 - b. Choose **Yes** or **No** to **New Patient?**
 - c. Confirm current profile or select a new profile.
 - d. Enter patient identifier, if required.
2. Perform steps in "Preparing Infusion" section, to:
 - a. Prepare syringe and administration set.
 - b. Load syringe and administration set.
 - c. Select syringe type and size, and **Guardrails Drug Library** as infusion type.
 - d. Prime.
3. Press **DRUG CALC** soft key.

A Guardrails Drug Library Adult ICU		
Aminophylline 50mg/50mL	A-E	
Bretylium 50 mg/25mL	F-J	
Dobutamine ___mg/___mL	K-O	
Dopamine 40mg/50mL	P-T	
Dopamine 8mg/25mL	U-Z	
>Select Drug/Concentration		
EXIT	DRUG CALC	PAGE DOWN

Setting Up Drug Calculation (Continued)

Using Non-Library Drug (Continued)

4. To enter DRUG AMOUNT in syringe, use numeric data entry keys.

A Drug Calculation	
DRUG AMOUNT	mcg
DILUENT VOLUME	mg
PATIENT WEIGHT	gram
TIME UNITS	unit
DOSING UNITS	mEq
>Enter Amount of Drug in Container	
DRUG LIBRARY	

5. Press soft key for appropriate unit of measure for drug amount.

A Drug Calculation	
DRUG AMOUNT	250 mcg
DILUENT VOLUME	mg
PATIENT WEIGHT	gram
TIME UNITS	unit
DOSING UNITS	mEq
>Select Unit of Measure	
DRUG LIBRARY	

6. To enter diluent volume, use numeric data entry keys.

A Drug Calculation	
DRUG AMOUNT	250 mg
DILUENT VOLUME	mL
PATIENT WEIGHT	
TIME UNITS	
DOSING UNITS	
>Enter Diluent Volume	
DRUG LIBRARY	

7. Press PATIENT WEIGHT soft key.

A Drug Calculation	
DRUG AMOUNT	250 mg
DILUENT VOLUME	50 mL
PATIENT WEIGHT	
TIME UNITS	
DOSING UNITS	
[Conc]: 5000 mcg/mL	
>Select PATIENT WEIGHT	
DRUG LIBRARY	

Setting Up Drug Calculation (Continued)

Using Non-Library Drug (Continued)

8. To indicate whether or not patient weight is to be used in Drug Calculation, press either **Yes** or **No** soft key.

NOTE: Do not enter a patient weight if weight is not used in the calculation.

A Drug Calculation	
DRUG AMOUNT	250 mg
DILUENT VOLUME	50 mL
PATIENT WEIGHT	> > >
	Yes
	No
Note: Press "Yes" only if Patient weight is used in the calculation. For Example: Dosing Units = mg/kg/h.	
>Use Patient Weight in Calculation?	
DRUG LIBRARY	

9. To enter patient weight (if required) in kilograms, use numeric data entry keys.

A Drug Calculation	
DRUG AMOUNT	250 mg
DILUENT VOLUME	50 mL
PATIENT WEIGHT	___ kg
TIME UNITS	
DOSING UNITS	
[Conc]: 5000 mcg/mL	
>Enter Patient Weight	
DRUG LIBRARY	

10. Press **TIME UNITS** soft key.

A Drug Calculation	
DRUG AMOUNT	250 mg
DILUENT VOLUME	50 mL
PATIENT WEIGHT	__ 70 kg
TIME UNITS	
DOSING UNITS	
[Conc]: 5000 mcg/mL	
>Select TIME UNITS	
DRUG LIBRARY	

11. To select time base for drug calculation, press either **Min**, **Hour**, or **Day** soft key.

A Drug Calculation	
DRUG AMOUNT	250 mg
DILUENT VOLUME	50 mL
PATIENT WEIGHT	70 kg
TIME UNITS	> > > >
DOSING UNITS	
[Conc]: 5000 mcg/mL	
>Select Time Units	
DRUG LIBRARY	

Setting Up Drug Calculation (Continued)

Using Non-Library Drug (Continued)

12. Press soft key next to desired DOSING UNITS.

A Drug Calculation	
DRUG AMOUNT	250 mg
DILUENT VOLUME	50 mL
PATIENT WEIGHT	70 kg
TIME UNITS	mcg/kg/min
DOSING UNITS	> > mg/kg/min
[Conc]: 5000 mcg/mL	
>Select the Desired Dosing Units	
DRUG LIBRARY	

13. Verify correct drug calculation infusion parameters and press NEXT soft key.

A Drug Calculation	
DRUG AMOUNT	250 mg
DILUENT VOLUME	50 mL
PATIENT WEIGHT	70 kg
TIME UNITS	Min
DOSING UNITS	mcg/kg/min
[Conc]: 5000 mcg/mL	
>Press NEXT to Confirm	
DRUG LIBRARY NEXT	

NOTE: If the ALL Mode is enabled, VTBI ALL displays. In the following illustrated examples, the ALL Mode is disabled.

A Drug Calculation	
CONTINUOUS INFUSION	
RATE	___ mL/h
VTBI	ALL
DOSE	___ mcg/kg/min
[Conc]: 5000 mcg/mL	
>Select RATE or DOSE	
SETUP BOLUS	

14. To make a rate or dose entry, press applicable soft key, RATE or DOSE, and use numeric data entry keys (other value is calculated and displayed).

A Drug Calculation	
CONTINUOUS INFUSION	
RATE	___ mL/h
VTBI	___ mL
DOSE	___ mcg/kg/min
[Conc]: 5000 mcg/mL	
>Select RATE or DOSE	
SETUP BOLUS	

Setting Up Drug Calculation (Continued)

Using Non-Library Drug (Continued)

15. To enter volume to be infused, press **VTBI** soft key and use numeric data entry keys.

NOTE: The **BOLUS** soft key appears only if Bolus Dose is enabled within the selected profile and a VTBI is entered.

NOTE: When VTBI equals ALL, the **ALL** soft key appears inactive when the **VTBI** soft key is pressed and active when a value is entered.

A Drug Calculation
CONTINUOUS INFUSION
RATE 4.2 mL/h
VTBI _ _ _ _ mL
DOSE _ _ _ _ 5 mcg/kg/min
[Conc]: 5000 mcg/mL
>Select VTBI
SETUP BOLUS

A Drug Calculation
CONTINUOUS INFUSION
RATE 4.2 mL/h
VTBI ALL
DOSE 5 mcg/kg/min
[Conc]: 5000 mcg/mL
>Press START
PAUSE SETUP BOLUS START

A Drug Calculation
CONTINUOUS INFUSION
RATE 4.2 mL/h
VTBI _ _ 50 mL ALL
DOSE 5 mcg/kg/min
[Conc]: 5000 mcg/mL
>Press START
PAUSE SETUP BOLUS START

-- Continued on Next Page --

Setting Up Drug Calculation (Continued)

Using Non-Library Drug (Continued)

16. Verify parameters are correct and press **START** soft key.
- During infusion:
 - ◆ Green Infusing Status Indicator illuminates.
 - ◆ Rate appears in Channel Rate Display.
 - ◆ VTBI counts down on Main Display.
 - ◆ Dose scrolls in Channel Message Display.
 - ◆ When infusion is close to being completed and NEOI is enabled:
 - Main Display alternates between **NEAR END** and remaining VTBI.
 - NEAR END** scrolls in Channel Message Display.
 - Yellow Standby Indicator flashes.
 - An audio prompt sounds.
 - At completion of infusion:
 - ◆ An audio prompt sounds.
 - ◆ Red Alarm Status Indicator flashes.
 - ◆ If KVO option is enabled:
 - Rate Display changes to KVO rate.
 - INFUSION COMPLETE–KVO** scrolls in Channel Message Display.
 - KVO** followed by **SYRINGE EMPTY** appears on Main Display.
 - ◆ If KVO option is disabled, and:
 - Syringe is not empty: **INFUSION COMPLETE** scrolls in Channel Message Display and **COMPLETE** appears on Main Display.
 - Syringe is empty: **SYRINGE EMPTY** scrolls in Channel Message Display and appears on Main Display.

A Drug Calculation
CONTINUOUS INFUSION
RATE 4.2 mL/h
VTBI 50 mL
DOSE 5 mcg/kg/min
[Conc]: 5000 mcg/mL
>Press START
PAUSE SETUP BOLUS START

Midtown Hospital Adult ICU
A COMPLETE
VOLUME INFUSED AUDIO ADJUST

Programming Bolus Dose

A bolus dose can be programmed at the beginning of, or during, an infusion. The drug being programmed must be a bolusable drug selected from the Guardrails® Drug Library or a non-library drug, as described in the following sections.

NOTES:

- If the Bolus Dose feature is enabled, the **BOLUS** soft key appears in the Continuous Infusion screen and becomes active when a VTBI is entered.
- The bolus VTBI cannot exceed the programmed continuous infusion VTBI.
- Programming and starting a bolus dose, deletes any programmed delay.
- If no continuous rate is entered, the infusion will end when the bolus has been delivered. No KVO infusion will follow.

Using Guardrails® Drug Library Calculation

1. Set up Drug Calculation as described in “Setting Up Drug Calculation”, “Using Guardrails® Drug Library” section, but do not start infusion.
2. Press **BOLUS** soft key.

Nonweight-based example. ➤

A Guardrails Drug Library Lidocaine
CONTINUOUS INFUSION
RATE 27 mL/h
VTBI 50 mL
DOSE 9 mg/min
[Conc]: 20 mg/mL
>Press START
PAUSE SETUP BOLUS START

Weight-based example. ➤

A Guardrails Drug Library Heparin
CONTINUOUS INFUSION
RATE 5.25 mL/h
VTBI 50 mL
DOSE 15 unit/kg/h
[Conc]: 200 units/mL
>Press START
PAUSE SETUP BOLUS START

-- Continued on Next Page --

Programming Bolus Dose (Continued)

Using Guardrails® Drug Library Calculation (Continued)

- DOSE is highlighted.

NOTES:

- If the programmed continuous dose infusion is outside the Guardrails® Soft Limit for that care area, a prompt appears before programming can continue. If the **Yes** soft key is pressed, programming continues; if the **No** soft key is pressed, the infusion needs to be reprogrammed.
- If the programmed continuous dose infusion is outside the Guardrails® Hard Limit for that care area, a prompt appears before programming can continue. The infusion needs to be reprogrammed.

3. To enter bolus dose, use numeric data entry keys.

NOTE: After a bolus dose and weight (if used) are entered, bolus VTBI and concentration [conc] alternate in the Main Display.

- If no weight has previously been programmed in system and bolus dose is weight-based, weight entry is empty.

A Guardrails Drug Library Lidocaine
BOLUS DOSE
DOSE _____ mg/kg
PATIENT WEIGHT
DURATION
[Conc]: 20 mg/mL
>Enter Bolus Dose
SETUP

- If programmed continuous dose is weight-based, programmed weight displays (as in illustrated example, which reflects use of Heparin in Pediatrics ICU).

A Guardrails Drug Library Heparin
BOLUS DOSE
DOSE _____ unit/kg
PATIENT WEIGHT 10 kg
DURATION
[Conc]: 200 units/mL
>Enter Bolus Dose
SETUP

- If bolus dose is not weight-based, **Not Used** displays in PATIENT WEIGHT field.

Programming Bolus Dose (Continued)

Using Guardrails® Drug Library Calculation (Continued)

4. To enter or change patient weight (if used), use applicable following procedure, depending on whether or not continuous dose is weight-based.
 - When continuous dose is not weight-based:
 - a. Press **PATIENT WEIGHT** soft key.

A Guardrails Drug Library Lidocaine
BOLUS DOSE
DOSE _ _ _ 5 mg/kg
PATIENT WEIGHT _ _ _ kg
DURATION
[Conc]: 20 mg/mL
>Select PATIENT WEIGHT
SETUP

- b. To enter patient weight, use numeric data entry keys.

A Guardrails Drug Library Lidocaine
BOLUS DOSE
DOSE 5 mg/kg
PATIENT WEIGHT _ _ _ kg
DURATION
[Conc]: 20 mg/mL
>Select DURATION
SETUP

-- OR --

- When continuous dose is weight-based:
 - a. Press **SETUP** soft key.

A Guardrails Drug Library Heparin
BOLUS DOSE
DOSE _ _ 50 unit/kg
PATIENT WEIGHT 10 kg
DURATION
TOTAL DOSE = 500 units
[Conc]: 200 units/mL
>Select DURATION
SETUP

-- Continued on Next Page --

Programming Bolus Dose (Continued)

Using Guardrails® Drug Library Calculation (Continued)

b. Press PATIENT WEIGHT soft key.

A Guardrails Drug Library Heparin	
DRUG AMOUNT	10000 units
DILUENT VOLUME	50 mL
PATIENT WEIGHT	10 kg
TIME UNITS	Hour
DOSING UNITS	units/kg/h
[Conc]: 200 units/mL	
>Press NEXT to Confirm	
DRUG LIBRARY	NEXT

c. To change patient weight, use numeric data entry keys.

d. Press NEXT soft key.

A Guardrails Drug Library Heparin	
DRUG AMOUNT	10000 units
DILUENT VOLUME	50 mL
PATIENT WEIGHT	__ 11 kg
TIME UNITS	Hour
DOSING UNITS	units/kg/h
[Conc]: 200 units/mL	
>Press NEXT to Confirm	
DRUG LIBRARY	NEXT

NOTE: If a continuous infusion is running, a prompt to confirm the weight change appears.

A Guardrails Drug Library Heparin	
Dose will recalculate based on new weight. Adjust Dose or Rate if required. Accept weight change?	
Yes	No
>Select Yes or No	

e. Press BOLUS soft key.

A Guardrails Drug Library Heparin			
CONTINUOUS INFUSION			
RATE	0.83 mL/h		
VTBI	50 mL		
DOSE	15 unit/kg/h		
[Conc]: 200 units/mL			
>Press START			
PAUSE	SETUP	BOLUS	START

-- Continued on Next Page --

Programming Bolus Dose (Continued)

Using Guardrails® Drug Library Calculation (Continued)

- f. To enter bolus dose, use numeric data entry keys.

A	Guardrails Drug Library Heparin
BOLUS DOSE	
DOSE	___ ___ unit/kg
PATIENT WEIGHT	11 kg
DURATION	
[Conc]: 200 units/mL	
>Enter Bolus Dose	
SETUP	

5. Press DURATION soft key.

A	Guardrails Drug Library Lidocaine
BOLUS DOSE	
DOSE	5 mg/kg
PATIENT WEIGHT	___ ___ 71 kg
DURATION	
TOTAL DOSE = 355 mg	
[Conc]: 20 mg/mL	
>Select DURATION	
SETUP	

6. To enter bolus duration, use numeric data entry keys.

OR

To deliver bolus dose at maximum rate possible for selected profile and setup, and automatically calculate bolus duration, press **Max Rate** soft key.

- TOTAL DOSE alternates with INFUSE AT rate.

A	Guardrails Drug Library Lidocaine
BOLUS DOSE	
DOSE	5 mg/kg
PATIENT WEIGHT	71 kg (999 mL/h)
DURATION	___ min Max Rate
TOTAL DOSE = 355 mg	
BOLUS VTBI = 17.8 mL	
>Enter Duration	
SETUP	

7. Verify parameters are correct and press START soft key.

- During infusion:
 - ◆ Green Infusing Status Indicator illuminates.
 - ◆ Rate appears in Channel Rate Display.
 - ◆ Dose and drug name scroll in Channel Message Display.

NOTE: If a continuous dose outside of the Guardrails® Soft Limits has been entered and verified as correct, the Channel Message Display also shows either "LLL" for a low dose or "↑↑↑" for a high dose.

A	Guardrails Drug Library Lidocaine
BOLUS DOSE	
DOSE	5 mg/kg
PATIENT WEIGHT	71 kg (999 mL/h)
DURATION	2 min Max Rate
INFUSE AT: 333 mg/min	
[Conc]: 20 mg/mL	
>Press START to Begin Infusing Bolus Dose	
PAUSE	SETUP
CONT- INUOUS	START

-- Continued on Next Page --

Programming Bolus Dose (Continued)

Using Guardrails® Drug Library Calculation (Continued)

- ◆ Main Display alternates between Bolus VTBI and drug name with dose.
- ◆ When continuous infusion is close to being completed and NEOI is enabled:
Main Display alternates between **NEAR END** and remaining VTBI.
NEAR END scrolls in Channel Message Display.
Yellow Standby Indicator flashes.
An audio prompt sounds.

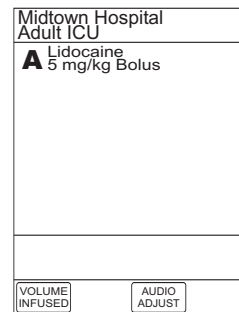
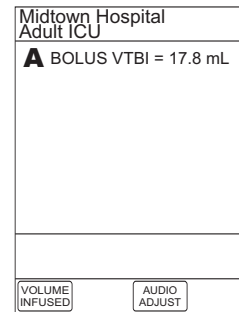

NOTE: To see details during the bolus infusion, press the **CHANNEL SELECT** key. The screen title alternates between "Guardrails Drug Library (drug name)" and identifying syringe model and size.

- At completion of bolus infusion:
 - ◆ System beeps twice.
 - ◆ **BOLUS DOSE COMPLETE** scrolls in Channel Message Display.

NOTE: If the bolus dose infusion is not followed immediately by a continuous dose infusion, **BOLUS COMPLETE** appears on the Main Display.

- ◆ Continuous dose infusion (if programmed) initiates.
- ◆ VTBI counts down on Main Display.

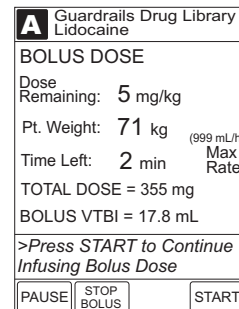

-- Continued on Next Page --

Programming Bolus Dose (Continued)

Using Guardrails® Drug Library Calculation (Continued)

- At completion of continuous infusion:
 - ◆ An audio prompt sounds.
 - ◆ Red Alarm Status Indicator flashes.
 - ◆ If KVO option is enabled:
 - Rate Display changes to KVO rate.
 - INFUSION COMPLETE–KVO** scrolls in Channel Message Display.
 - KVO** followed by **SYRINGE EMPTY** appears on Main Display.
 - ◆ If KVO option is disabled, and:
 - Syringe is not empty: **INFUSION COMPLETE** scrolls in Channel Message Display and **COMPLETE** appears on Main Display.
 - Syringe is empty: **SYRINGE EMPTY** scrolls in Channel Message Display and appears on Main Display.

Using Non-Library Drug Calculation

1. Set up Drug Calculation as described in “Setting Up Drug Calculation”, “Using Non-Library Drug” section, but do not start infusion.
2. Press **BOLUS** soft key.
 - **DOSE** is highlighted.

A Drug Calculation	
CONTINUOUS INFUSION	
RATE	4.2 mL/h
VTBI	50 mL
DOSE	5 mcg/kg/min
[Conc]: 5000 mcg/mL	
>Press START	
PAUSE	SETUP
BOLUS	START

3. To enter bolus dose, use numeric data entry keys.

NOTE: After a bolus dose and weight (if used) are entered, bolus VTBI and concentration [conc] alternate in the Main Display.

4. Press soft key for appropriate unit of measure for dose.

NOTE: If **mcg** or **mg** is selected as the dosing unit, a **PATIENT WEIGHT** entry cannot be made. If **mcg/kg** or **mg/kg** is selected as the dosing unit, a **PATIENT WEIGHT** entry is required.

A Drug Calculation	
BOLUS DOSE	mcg
DOSE _ 2000	mcg/kg
PATIENT WEIGHT	mg
DURATION	mg/kg
[Conc]: 5000 mcg/mL	
>Select the Desired Dosing Units	
SETUP	

Programming Bolus Dose (Continued)

Using Non-Library Drug Calculation (Continued)

5. To enter bolus duration, use numeric data entry keys.

OR

To deliver bolus dose at maximum rate possible for selected profile and setup, and automatically calculate bolus duration, press **Max Rate** soft key.

- **TOTAL DOSE** alternates with **INFUSE AT** rate.

A Drug Calculation	
BOLUS DOSE	
DOSE	2000 mcg
PATIENT WEIGHT	Not Used (999 mL/h)
DURATION	_ _ min Max Rate
TOTAL DOSE = 2000 mg	
[Conc]: 5000 mcg/mL	
>Enter Duration	
SETUP	

6. Verify parameters are correct and press **START** soft key.

- During infusion:
 - ◆ Green Infusing Status Indicator illuminates.
 - ◆ Rate appears in Channel Rate Display.
 - ◆ Dose scrolls in Channel Message Display.
 - ◆ Bolus VTBI counts down on Main Display.
 - ◆ When continuous infusion is close to being completed and NEOI is enabled:

Main Display alternates between **NEAR END** and remaining VTBI.

NEAR END scrolls in Channel Message Display.

Yellow Standby Indicator flashes.

An audio prompt sounds.

A Drug Calculation	
BOLUS DOSE	
DOSE	2000 mcg
PATIENT WEIGHT	Not Used (999 mL/h)
DURATION	<1 min Max Rate
INFUSE AT: >9999 mcg/min	
[Conc]: 5000 mcg/mL	
>Press START to Begin Infusing Bolus Dose	
PAUSE	SETUP CONT- INUOUS
START	

Midtown Hospital Adult ICU	
A BOLUS VTBI = 0.4 mL	
VOLUME INFUSED	AUDIO ADJUST

NOTE: To see details during the bolus infusion, press the **CHANNEL SELECT** key.

A Drug Calculation	
BOLUS DOSE	
Dose Remaining:	2000 mcg
Pt. Weight:	Not Used (999 mL/h)
Time Left:	<1 min Max Rate
TOTAL DOSE: 2000 mcg	
BOLUS VTBI = 0.4 mL	
>Press START to Continue Infusing Bolus Dose	
PAUSE	STOP BOLUS
START	

-- Continued on Next Page --

Programming Bolus Dose (Continued)

Using Non-Library Drug Calculation (Continued)

- At completion of bolus infusion:
 - ◆ System beeps twice.
 - ◆ **BOLUS DOSE COMPLETE** scrolls in Channel Message Display.
- NOTE:** *If the bolus dose infusion is not followed immediately by a continuous dose infusion, **BOLUS COMPLETE** appears on the Main Display.*
- ◆ Continuous dose infusion (if programmed) initiates.
 - ◆ VTBI counts down on Main Display.
 - At completion of continuous infusion:
 - ◆ An audio prompt sounds.
 - ◆ Red Alarm Status Indicator flashes.
 - ◆ If KVO option is enabled:
 - Rate Display changes to KVO rate.
 - INFUSION COMPLETE–KVO** scrolls in Channel Message Display.
 - KVO** followed by **SYRINGE EMPTY** appears on Main Display.
 - ◆ If KVO option is disabled, and:
 - Syringe is not empty: **INFUSION COMPLETE** scrolls in Channel Message Display and **COMPLETE** appears on Main Display.
 - Syringe is empty: **SYRINGE EMPTY** scrolls in Channel Message Display and appears on Main Display.

Stopping Bolus Dose

NOTE: *The display examples in this section represent stopping a bolus dose which was programmed using the Guardrails® Drug Library. Even where the displays are different when stopping a bolus dose which was programmed using a non-library drug, the procedure is the same.*

1. Press **CHANNEL SELECT** key.

Programming Bolus Dose (Continued)

Stopping Bolus Dose (Continued)

- Press **STOP BOLUS** soft key.

A Guardrails Drug Library Lidocaine		
BOLUS DOSE		
Dose Remaining: 5 mg/kg		
Pt. Weight: 71 kg	(999 mL/h) Max Rate	
Time Left: 2 min		
TOTAL DOSE = 355 mg		
BOLUS VTBI = 17.8 mL		
>Press START to Continue Infusing Bolus Dose		
PAUSE	STOP BOLUS	START

- To stop bolus and start continuous infusion, press **Yes** soft key.

A Guardrails Drug Library Lidocaine	
Stop Bolus and Start Continuous infusion?	Yes
	No
>Press Yes or No	

- To stop continuous infusion, press and hold **CHANNEL OFF** key until a beep is heard (approximately 1.5 seconds).

Midtown Hospital Adult ICU	
A VTBI = 50 mL	
VOLUME INFUSED	AUDIO ADJUST

Restoring Bolus Dose

A bolus dose can be restored after it has completed, either prior to or after the channel has been turned off, as indicated in the following sections.

NOTE: The display examples in this section represent restoring a bolus dose which was programmed using the Guardrails® Drug Library. Even where the displays are different when restoring a bolus dose which was programmed using a non-library drug, the procedure is the same.

Programming Bolus Dose (Continued)

Restoring Bolus Dose (Continued)

Bolus Dose Completed - Channel Not Turned Off

1. Press CHANNEL SELECT key.
2. Verify infusion parameters and press BOLUS soft key.

A Guardrails Drug Library Lidocaine
CONTINUOUS INFUSION
RATE 27 mL/h
VTBI 50 mL
DOSE 9 mg/min
[Conc]: 20 mg/mL
>Press START
PAUSE SETUP BOLUS START

3. Press RESTORE soft key.

A Guardrails Drug Library Lidocaine
BOLUS DOSE
DOSE _____ mg/kg
PATIENT WEIGHT 71 kg
DURATION
[Conc]: 20 mg/mL
>Enter Bolus Dose
RESTORE SETUP

4. Verify dosing parameters and press START soft key.

A Guardrails Drug Library Lidocaine
BOLUS DOSE
DOSE 5 mg/kg
PATIENT WEIGHT 71 kg (999 mL/h)
DURATION 2 min Max Rate
INFUSE AT: 333 mg/min
[Conc]: 20 mg/mL
>Press START to Begin Infusing Bolus Dose
PAUSE SETUP CONT- INUOUS START

Bolus Dose Completed - Channel Turned Off

1. Press CHANNEL SELECT key.
2. Press RESTORE soft key.

A Infusion Menu
Guardrails Drug Library
Basic infusion
>Select an Option or EXIT
RESTORE EXIT

Programming Bolus Dose (Continued)

Restoring Bolus Dose (Continued)

Bolus Dose Completed - Channel Turned Off (Continued)

3. Verify parameters and press **NEXT** soft key.

A Guardrails Drug Library Lidocaine	
DRUG AMOUNT	1 gram
DILUENT VOLUME	50 mL
PATIENT WEIGHT	Not Used
TIME UNITS	min
DOSING UNITS	mg/min
[Conc]: 20 mg/mL	
>Press NEXT to Confirm	
NEXT	

4. Verify infusion parameters and press **BOLUS** soft key.

A Guardrails Drug Library Lidocaine			
CONTINUOUS INFUSION			
RATE	27 mL/h		
VTBI	50 mL		
DOSE	9 mg/min		
[Conc]: 20 mg/mL			
>Press START			
PAUSE	SETUP	BOLUS	START

5. Press **RESTORE** soft key.

A Guardrails Drug Library Lidocaine	
BOLUS DOSE	
DOSE	___ mg/kg
PATIENT WEIGHT	71 kg
DURATION	
[Conc]: 20 mg/mL	
>Enter Bolus Dose	
RESTORE	SETUP

6. Verify dosing parameters and press **START** soft key.

A Guardrails Drug Library Lidocaine			
BOLUS DOSE			
DOSE	5 mg/kg		
PATIENT WEIGHT	71 kg (999 mL/h)		
DURATION	2 min Max Rate		
INFUSE AT: 333 mg/min			
[Conc]: 20 mg/mL			
>Press START to Begin Infusing Bolus Dose			
PAUSE	SETUP	CONT- INUOUS	START

Anesthesia Mode

When the Medley™ System is operating in Anesthesia Mode, a channel can be paused indefinitely without an alarm. Anesthesia Mode also makes it possible to have additional drugs in each profile, which are only accessible when operating in Anesthesia Mode.

NOTE: When the Anesthesia Mode is disabled while a Pump Module is paused, the Pump Module remains in an indefinite pause, until the module is restarted.

When Anesthesia Mode is enabled:

- All Guardrails® Limits are set to “Soft”.
- Dose checking mode is set to “Smart”.
- Key-press audio is turned off.
- Tamper Resist Mode (panel locked) is not available.
- All Guardrails® Drug Library entries are available for selection.
- Bolus dose is automatically available for:
 - ◆ drugs in Guardrails® Drug Library that have bolus dose limits defined, and
 - ◆ generic drug calculation setup, regardless of system configuration settings.
- **Anesthesia Mode**, alternating with other required prompts, displays in prompt bar of Main Display.
- Callback audio for paused channels is permanently silenced.
- Review of drug calculation setup page is omitted when restoring a stopped drug calculation.

CAUTION

When the Medley™ System is set up for use in Anesthesia Mode, it is important to select the profile that corresponds with the care area the patient will be taken to when the Anesthesia Mode is discontinued. This ensures that the Medley™ System will be in the correct profile following the use of the Anesthesia Mode.

Enabling Anesthesia Mode

1. From Main Display, press **OPTIONS** key.
2. Press **Anesthesia Mode** soft key.

System Options 1 of 3
Display Contrast
Patient ID
Time of Day
Power Down All Channels
Anesthesia Mode
>Select an Option or EXIT
EXIT PAGE DOWN

Anesthesia Mode (Continued)

Enabling Anesthesia Mode (Continued)

3. Press **Enable** soft key.
4. Press **CONFIRM** soft key.

System Options	
Anesthesia Mode	
	Enable
	Disable
Pump Module	Change
Air Detection = 75 microliters	
>Select an Option or Press CONFIRM	
	CONFIRM

5. Press **Channel Select** key.
6. Program Anesthesia Mode infusion using same procedure as for any other continuous infusion.

Midtown Hospital Adult ICU	
A	
B	
C	
D	
Anesthesia Mode	
VOLUME INFUSED	AUDIO ADJUST

Disabling Anesthesia Mode

The Anesthesia Mode can be disabled, and normal operation resumed, using either of the following three methods:

- System Options menu.
- Disconnecting system from AC power.
- Connecting system to AC power.

From System Options Menu

1. While operating in Anesthesia Mode, press **OPTIONS** key.
2. Press **Anesthesia Mode** soft key.

System Options 1 of 3	
Display Contrast	
Patient ID	
Time of Day	
Power Down All Channels	
Anesthesia Mode	
>Select an Option or EXIT	
EXIT	PAGE DOWN

Anesthesia Mode (Continued)

Disabling Anesthesia Mode (Continued)

From System Options Menu (Continued)

- Press **Disable** soft key.
- Press **CONFIRM** soft key.
 - Anesthesia Mode** no longer appears on Main Display, indicating it has been disabled.

System Options	
Anesthesia Mode	<input type="button" value="Enable"/> <input checked="" type="button" value="Disable"/>
Pump Module Air Detection = 75 microliters	<input type="button" value="Change"/>
>Select an Option or Press CONFIRM	
<input type="button" value="CONFIRM"/>	

Disconnecting System from AC Power While in Anesthesia Mode

- Disconnect system from AC.
 - Anesthesia Mode is automatically disabled.
 - All currently running infusions continue.
 - A prompt appears as an alert that Anesthesia Mode has been discontinued.
- Press **CONFIRM** soft key.

Anesthesia mode was discontinued when AC power cord was disconnected. Press CONFIRM to continue normal operation.	
<input type="button" value="CONFIRM"/>	

Connecting System to AC Power While in Anesthesia Mode

- Connect system to AC power.
- To continue using Anesthesia Mode, press **Yes** soft key.
OR
To discontinue Anesthesia Mode, press **No** soft key.

AC power cord was connected. Continue ANESTHESIA MODE?	<input type="button" value="Yes"/> <input type="button" value="No"/>
>Select Yes or No	

Delay Options

Delay Options can be enabled at the time the Medley™ System is configured for use. If Delay Options is enabled, an infusion can be programmed to be delayed for a specified period of time and a callback can be scheduled, as described in the following sections.

NOTE: Since by definition, an infusion with Delay Options will not be infusing for a programmed period of time, it is assumed that another infusing IV line will keep the vein open until the delayed infusion begins. When a delay is programmed, the infusion stops when complete and no KVO is delivered.

Delaying Infusion

The delay period for an infusion can be programmed as a specific number of minutes or a time of day, as described in the following sections. An infusion delay can be programmed prior to or after an infusion is initiated.

Specifying by Minutes

The **Delay for** option is used to program an infusion delay for a minimum of one minute and up to 120 minutes.

1. Press **DELAY OPTIONS** soft key.

A IVAC 50 mL
RATE 40 mL/h
VTBI ALL
>Press START
DELAY OPTIONS VOLUME DURATION START

2. Press **Delay for** soft key.

A Delay Options 08:00
Pause
Delay for
Delay until
CALL BACK
>Select a Delay Option
BACK CONFIRM

Delay Options (Continued)

Delaying Infusion (Continued)

Specifying by Minutes (Continued)

- To enter number of minutes (up to 120) infusion is to be delayed for, use numeric data entry keys.

A Delay Options 08:00
Pause
Delay for ___ minutes
Delay until
CALL BACK
>Enter Delay Time
(1 - 120 min)
BACK CONFIRM

- Press **CONFIRM** soft key.

A Delay Options 08:00
Pause
Delay for _ 20 minutes
Delay until
CALL BACK None
>Select Callback or Press
CONFIRM
BACK CONFIRM

- Delay period counts down on Main Display.

Midtown Hospital 08:00
Adult ICU
A Start in 20 min
VOLUME INFUSED AUDIO ADJUST

- If a **Before** callback has not been scheduled (reference "Scheduling a Callback" section), infusion automatically initiates at end of delay period.

Midtown Hospital 09:00
Adult ICU
A VTBI = ALL (50 mL)
VOLUME INFUSED AUDIO ADJUST

Delay Options (Continued)

Delaying Infusion (Continued)

Specifying by Time of Day

The **Delay until** option is used to program an infusion delay for a minimum of one minute and up to 23 hours 59 minutes.

1. Press **DELAY OPTIONS** soft key.

A IVAC 50 mL
RATE 40 mL/h
VTBI ALL
>Press START
DELAY OPTIONS VOLUME DURATION START

2. Press **Delay until** soft key.

A Delay Options 08:00
Pause
Delay for
Delay until
CALL BACK
>Select a Delay Option
BACK CONFIRM

3. If **Current time** displayed is correct, press **CONFIRM** soft key; otherwise, press **Change Time** and enter correct time. (Reference "Setting Up Time of Day" procedure in Medley™ Programming Module Directions for Use.)

NOTE: If the current time has been previously confirmed, the **Time of Day** screen will not be displayed.

A Delayed Options
Time of Day
Current time: 08:00 Change Time
>CONFIRM Time-of-Day
CONFIRM

4. To enter time of day infusion is to be initiated (up to 23 hours 59 minutes), use numeric data entry keys.

A Delay Options 08:00
Pause
Delay for
Delay until :
CALL BACK
>Enter Delay Time
BACK CONFIRM

Delay Options (Continued)

Delaying Infusion (Continued)

Specifying by Time of Day (Continued)

5. Press **CONFIRM** soft key.

A Delay Options 08:00
Pause
Delay for
Delay until _ 9:00
CALL BACK None
>Select Callback or Press CONFIRM
BACK CONFIRM

- Time infusion is scheduled to start appears on Main Display.

Midtown Hospital Adult ICU 08:00
A Start at 09:00
VOLUME INFUSED AUDIO ADJUST

- If a **Before** callback has not been scheduled (reference "Scheduling a Callback" section), infusion automatically initiates at end of delay period.

Midtown Hospital Adult ICU 09:00
A VTBI = ALL (50 mL)
VOLUME INFUSED AUDIO ADJUST

Delay Options (Continued)

Scheduling a Callback

When programming a **Delay for** or **Delay until** infusion, a callback can be scheduled for that infusion. There are three types of callback:

- **Before** - gives an alert when delay is completed and infusion needs to be initiated.
- **After** - gives an alert when delayed infusion has completed.
- **Before and After** - gives an alert when delay is completed and infusion needs to be initiated and when delayed infusion has completed.

The default callback (**None**), or the callback for the current profile, appears on the Main Display. To schedule a different callback:

1. Prior to pressing **CONFIRM** soft key to initiate delay during **Delay for** or **Delay until** programming process, press **CALL BACK** soft key.

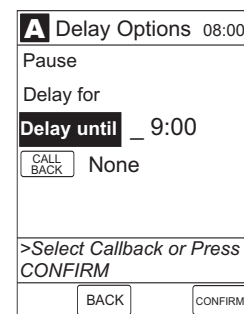

2. Press soft key corresponding to desired callback option.
 - Scheduled callback appears on Main Display.

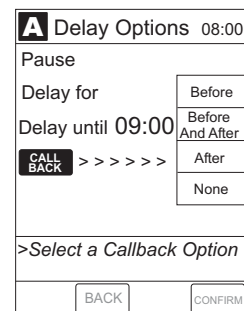

3. To initiate delay, press **CONFIRM** soft key.

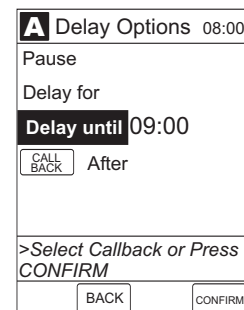

-- Continued on Next Page --

Delay Options (Continued)

Scheduling a Callback (Continued)

- If **Delay until** programming, time infusion is scheduled to start appears on Main Display.

OR

- If **Delay for** programming, delay period counts down on Main Display.

- If **Before** option was selected:
 - ◆ An audio prompt sounds when delay period has ended.
 - ◆ Yellow Standby Status Indicator flashes.
 - ◆ **DELAY COMPLETE** scrolls in Channel Message Display and appears on Main Display.

- If **After** option was selected:
 - ◆ An audio prompt sounds when delayed infusion completes, and continues to sound until responded to.
 - ◆ Yellow Standby Status Indicator flashes until audio is silenced.
 - ◆ Infusion completed message appears on Main Display.
 - ◆ **Infusion Complete** scrolls in Channel Message Display.
- If **Before and After** option was selected, same prompts and indicators mentioned above for both **Before** and **After** options are exhibited.

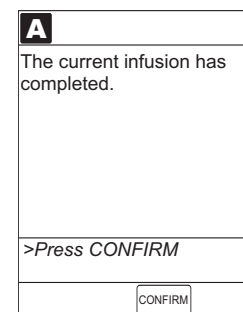
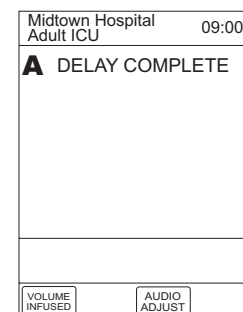
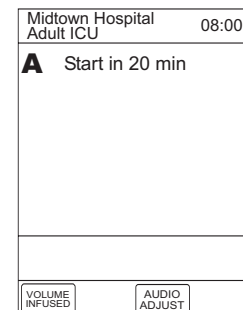
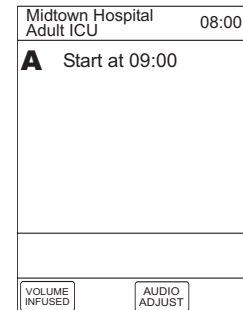

Delay Options (Continued)

Scheduling a Callback (Continued)

- To respond to a callback:
 - Before** callback
Press CHANNEL SELECT key and then START soft key.
OR
Press RESTART key.
 - After** callback
Press CONFIRM soft key.
 - Before and After** callback
Respond as indicated above for both **Before** and **After**.

Pausing Infusion

- Press DELAY OPTIONS soft key.

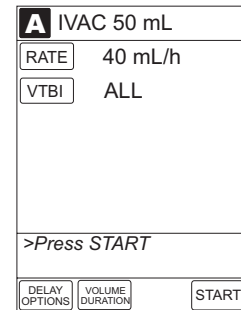

- Press Pause soft key.

NOTES:

- Using the **Pause** function in the Delay Options screen is the same as pressing the **PAUSE** key on the Syringe Module.
- The time displayed in the upper right corner of the screen is the time of day in a 24-hour clock format (military time).

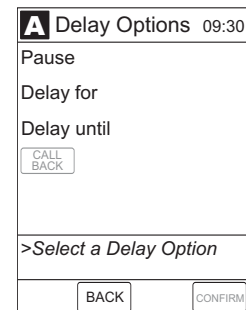

- Press CONFIRM soft key.
 - PAUSE** scrolls in Channel Message Display.
 - PAUSED** appears on Main Display.
 - Yellow Standby Status Indicator illuminates.
 - After two minutes: **PAUSE - RESTART CHANNEL** visual and audio prompts begin, and yellow Standby Status Indicator flashes.

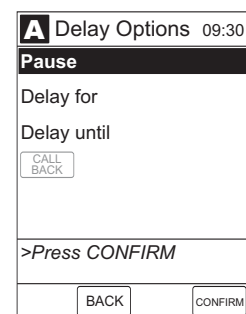

Delay Options (Continued)

Pausing Infusion (Continued)

4. To reinitiate infusion:
 - Press **RESTART** key.
 - OR
 - Press **CHANNEL SELECT** key and then **START** soft key.

A	IVAC 50 mL	
RATE	40 mL/h	
VTBI	ALL	
>Press START		
DELAY OPTIONS	VOLUME DURATION	START

Multidose Mode

NOTES:

- *Since, by definition, a multidose infusion will not be infusing for a programmed period of time, it is assumed that another infusing IV line will keep the vein open until the beginning of the first dose and between subsequent doses. There is no keep vein open (KVO) infusion at the completion of a programmed **Delay until** infusion.*
- *ALL Mode is not supported in Multidose Mode.*
- *The Delay Options function for multidose infusions is similar to Delay Options for continuous drug infusions, with the following differences:*
 - ◆ ***Delay for** option (when scheduling a callback) is not available in Multidose Mode.*
 - ◆ *Maximum allowable delay on a multidose infusion is 8 hours.*

WARNINGS

- The Multidose feature is to be used only by personnel properly trained in using multidose infusions.
- Caution labels, which clearly differentiate single dose and multidose containers, must be utilized.

Programming with Volume / Duration Enabled

If Volume/Duration was enabled at the time the Medley™ System was configured for use, use the following procedure to program a multidose infusion.

1. Perform steps in “Start-Up” section, to:
 - a. Power on system.
 - b. Choose **Yes** or **No** to **New Patient?**
 - c. Confirm current profile or select a new profile.
 - d. Enter patient identifier, if required.

Multidose Mode (Continued)

Programming with Volume / Duration Enabled (Continued)

2. Perform steps in "Preparing Infusion" section, to:
 - a. Prepare syringe and administration set.
 - b. Load syringe and administration set.
 - c. Select syringe type and size (and **Basic Infusion** as infusion type).
 - d. Prime.
3. Press **OPTIONS** key.

4. Press **Multidose** soft key.

A Channel Options 1 of 1
Guardrails Drug Library
Multidose
Pressure Limit - 550 mmHg
Prime Set with Syringe
Channel Labels
>Select an Option or EXIT
EXIT

5. If **Current time** displayed is correct, press **CONFIRM** soft key; otherwise, press **Change Time** and enter correct time. (Reference "Setting Up Time of Day" procedure in Medley™ Programming Module Directions for Use.)

NOTE: If the current time has been previously confirmed, the **Time of Day** screen will not be displayed.

A Multidose
Time of Day
Current time: 08:00 Change Time
>CONFIRM Time-of-Day
CONFIRM

6. Press **VOLUME DURATION** soft key.

A Multidose 08:00
RATE _____ mL/h
VOLUME/DOSE
DOSE INTERVAL
OF DOSES
>Enter Rate
VOLUME DURATION

Multidose Mode (Continued)

Programming with Volume / Duration Enabled (Continued)

7. To enter volume to be infused for each dose, use numeric data entry keys.

A Multidose	08:00
RATE =	___ mL/h
VOLUME/DOSE	___ mL
DURATION	
DOSE INTERVAL	
# OF DOSES	
>Enter Volume/Dose	
RATE VOLUME	

8. To enter duration for each dose, press **DURATION** soft key and use numeric data entry keys.

NOTE: *RATE is calculated with each keystroke for DURATION.*

A Multidose	08:00
RATE =	___ mL/h
VOLUME/DOSE	10 mL
DURATION	___ h ___ min
DOSE INTERVAL	
# OF DOSES	
>Enter Duration	
RATE VOLUME	

9. To enter time interval (1 to 24 hours) between doses, press **DOSE INTERVAL** soft key and use numeric data entry keys.

A Multidose	08:00
RATE =	20 mL/h
VOLUME/DOSE	10 mL
DURATION	___:30 hh:mm
DOSE INTERVAL	
# OF DOSES	
>Select DOSE INTERVAL	
RATE VOLUME	

10. To enter number of doses, press **#OF DOSES** soft key and use numeric data entry keys.

- If Delay Options is enabled, **DELAY OPTIONS** soft key appears.

NOTE: *Reference "Delay Options" section to program an infusion delay. When delaying an infusion, a multidose cannot be delayed for more than 8 hours, and all doses in the multidose program must be completed within a 24-hour program.*

A Multidose	08:00
RATE =	20 mL/h
VOLUME/DOSE	10 mL
DURATION	00 h 30 min
DOSE INTERVAL	every _ 6 h
# OF DOSES	
>Select NUMBER OF DOSES	
RATE VOLUME	

Multidose Mode (Continued)

Programming with Volume / Duration Enabled (Continued)

11. To begin multidose infusion, press **START** soft key.

A Multidose	08:00
RATE =	20 mL/h
VOLUME/ DOSE	10 mL
DURATION	00 h 30 min
DOSE INTERVAL	every 06 h
# OF DOSES	_ 4 doses
>Press START	
PAUSE	RATE VOLUME
	START

- Main Display shows remaining VTBI for that dose.

Midtown Hospital Adult ICU	08:00
A VTBI = 10 mL	
VOLUME INFUSED	AUDIO ADJUST

- At completion of a multidose program, **MULTIDOSE COMPLETE** appears on Main Display.

NOTE: If *NEOI* is enabled, the *Near End of infusion* message appears near the end of the last dose.

Midtown Hospital Adult ICU	02:30
A MULTIDOSE COMPLETE	
VOLUME INFUSED	AUDIO ADJUST

12. To see detail screen during or between infusions, press **CHANNEL SELECT** key.

- During infusion, **Volume Remaining** displays.

A Multidose	08:10
Rate =	20 mL/h
Volume/= Dose	10 mL
Duration =	00 h 30 min
	every 06 h x 04 doses
Doses completed =	0
Volume remaining =	7 mL
>Press START	
PAUSE	START

-- Continued on Next Page --

Multidose Mode (Continued)

Programming with Volume / Duration Enabled (Continued)

- Between infusions:
 - ◆ Number of doses completed and when next dose starts display.
 - ◆ Yellow Standby Status Indicator illuminates.

A Multidose	08:35
Rate = 20 mL/h	
Volume/= 10 mL	
Dose	
Duration = 00 h 30 min	
every 06 h x 04 doses	
Doses completed = 1	
Dose 2 Starts 14:00	
>Press START	
PAUSE	START

Programming with Volume / Duration Disabled

If Volume/Duration was not enabled at the time the Medley™ System was configured for use, use the following procedure to program a multidose infusion.

1. Perform steps in “Start-Up” section, to:
 - a. Power on system.
 - b. Choose **Yes** or **No** to **New Patient?**
 - c. Confirm current profile or select a new profile.
 - d. Enter patient identifier, if required.
2. Perform steps in “Preparing Infusion” section, to:
 - a. Prepare syringe and administration set.
 - b. Load syringe and administration set.
 - c. Select syringe type and size (and **Basic Infusion** as infusion type).
 - d. Prime.
3. Press **OPTIONS** key.

4. Press **Multidose** soft key.

A Channel Options 1 of 1
Guardrails Drug Library
Multidose
Pressure Limit - 550 mmHg
Prime Set with Syringe
Channel Labels
>Select an Option or EXIT
EXIT

Multidose Mode (Continued)

Programming with Volume / Duration Disabled (Continued)

5. To enter rate, use numeric data entry keys.

A Multidose	08:00
RATE	_____ mL/h
VOLUME/ DOSE	
DOSE INTERVAL	
# OF DOSES	
>Enter Rate	

6. To enter volume to be infused for each dose, press **VOLUME/DOSE** soft key and use numeric data entry keys.

A Multidose	08:00
RATE	20 mL/h
VOLUME/ DOSE	_____ mL
DOSE INTERVAL	
# OF DOSES	
>Enter Volume/Dose	

7. To enter time interval (1 to 24 hours) between doses, press **DOSE INTERVAL** soft key and use numeric data entry keys.

A Multidose	08:00
RATE	20 mL/h
VOLUME/ DOSE	10 mL
DOSE INTERVAL	every ___ h
# OF DOSES	
>Enter Dose Interval	

8. To enter number of doses, press **#OF DOSES** soft key and use numeric data entry keys.

- If Delay Options is enabled, **DELAY OPTIONS** soft key appears.

NOTE: Reference "Delay Options" section to program an infusion delay. When delaying an infusion, a multidose cannot be delayed for more than 8 hours, and all doses in the multidose program must be completed within a 24-hour program.

A Multidose	08:00
RATE	20 mL/h
VOLUME/ DOSE	10 mL
DOSE INTERVAL	every _ 6 h
# OF DOSES	
>Select NUMBER OF DOSES	

Multidose Mode (Continued)

Programming with Volume / Duration Disabled (Continued)

9. To begin multidose infusion, press **START** soft key.

A Multidose	08:00
RATE	20 mL/h
VOLUME/ DOSE	10 mL
DOSE INTERVAL	every 06 h
# OF DOSES	_ 4 doses
>Press START	
PAUSE	START

- Main Display shows remaining VTBI for that dose.

Midtown Hospital Adult ICU	08:00
A VTBI = 10 mL	
VOLUME INFUSED	AUDIO ADJUST

- At completion of a multidose program, **MULTIDOSE COMPLETE** appears on Main Display.

NOTE: If *NEOI* is enabled, the *Near End of infusion* message appears near the end of the last dose.

Midtown Hospital Adult ICU	02:30
A MULTIDOSE COMPLETE	
VOLUME INFUSED	AUDIO ADJUST

10. To see detail screen during or between infusions, press **CHANNEL SELECT** key.

- During infusion, **Volume Remaining** displays.

A Multidose	08:10
Rate =	20 mL/h
Volume/ Dose	= 10 mL
every 06 h x 04 doses	
Doses completed =	0
Volume remaining =	7 mL
>Press START	
PAUSE	START

-- Continued on Next Page --

Multidose Mode (Continued)

Programming with Volume / Duration Disabled (Continued)

- Between infusions:
 - ◆ Number of doses completed and when next dose starts displays.
 - ◆ Yellow Standby Status Indicator illuminates.

A Multidose	08:35
Rate = 20 mL/h Volume/ = 10 mL Dose	
every 06 h x 04 doses Doses completed = 1 Dose 2 Starts 14:00	
>Press START	
PAUSE	START

Reviewing Serial Number

Refer to the Medley™ Programming Module Directions for Use.

Reviewing Software Version

Refer to the Medley™ Programming Module Directions for Use.

THIS PAGE
INTENTIONALLY
LEFT BLANK

ALARMS, ERRORS, MESSAGES

To enhance safety and ease of operation, the Medley™ System provides a full range of audio and visual alarms, errors, and messages.

Definitions

Advisory	A sequence of audio and/or visual signals indicating the operating status of the Medley™ Medication Safety System. The audio may be silenced for approximately two minutes by pressing the SILENCE key.
Alarm	An audio and visual signal that a potentially unsafe condition is present. Immediate action is required. The audio may be silenced for approximately two minutes by pressing the SILENCE key.
Error	An audio and/or visual signal that a failure has been detected. Immediate action is required.
Guardrails® Alert	A visual message to help reduce programming errors by indicating a Guardrails® Limit (“soft” or “hard”) has been exceeded. A response is required before programming can continue.
Guardrails® Clinical Advisory	A visual message when a designated drug is selected, to remind clinician of specific hospital standards of practice when programming an IV medication. A specific clinical advisory can be associated with a selected drug within any of the patient care profiles.
Maintenance Reminder	A visual message that, when enabled, appears at module startup when scheduled preventive maintenance is due/overdue for any part of the Medley™ System (Programming Module or attached module).
Prompt	A visual message, appearing on the bottom line of the Main Display or in the Channel Message Display. The message may be accompanied by an audio signal that can be silenced for twelve seconds by pressing the SILENCE key.

Audio Characteristics

The Programming Module and Main Display provide various types of alert information. The characteristics of the accompanying audio sounds are as follows:

Type	Sound	Notes
Advisory	One short beep every two seconds	Variable volume; can be silenced for two minutes.
Alarm	Choice of three alarm audio profiles, selectable in System Configuration	Variable volume; can be silenced for two minutes.
Error (Hardware Detected)	Pairs of long beeps	Fixed maximum decibel volume; cannot be silenced.
Error (Software Detected)	Pairs of long beeps	Fixed maximum decibel volume; can be silenced for two minutes.
Illegal Key Press	Two short beeps	Variable volume; cannot be silenced.
Key Click	One short beep	Fixed minimum volume; can be silenced and disabled in System Configuration.
Prompt	One short beep every two seconds	Variable volume; can be silenced.
Switchover	Two short beeps: bolus switching to continuous.	Variable volumes; can be silenced and disabled in System Configuration.

Alarms

Alarm	Meaning	Response
Channel Disconnected	Channel(s) disconnected while in operation or have a communication problem.	To silence alarm and clear message from screen, press CONFIRM soft key. Reattach channel if desired, ensuring it is securely “clicked” into place at Channel Release Latch. If alarm is still present, replace channel with an operational instrument.
Check Syringe	Plunger grippers opened during infusion and then closed. Infusion stops on affected channel. ➤	Securely lock plunger grippers, press CHANNEL SELECT key, and reselect syringe.
	Syringe barrel clamp opened during infusion and then closed. Infusion stops on affected channel. ➤	Securely lock syringe barrel clamp and press RESTART key.
	Syringe plunger not captured while in idle state. System alarms after 30 seconds, to indicate potential siphoning condition. ➤	Check for potential siphoning. Ensure administration set clamp (roller/slide) is in closed position. Securely lock plunger grippers over syringe plunger.
Occlusion	Increased back pressure sensed while infusing. Infusion stops on affected channel.	Clear occlusion. Press RESTART key, or press CHANNEL SELECT key and then START soft key.
Pressure Disc Installed	Pressure sensing disc installed during an infusion. Infusion stops on affected channel.	Press CONFIRM soft key and restart infusion.
Pressure Disc Removed	Pressure sensing disc removed. Infusion stops on affected channel.	Reinsert pressure sensing disc and press RESTART key.
Syringe Empty	Syringe is empty. ➤	Set up new infusion or press CHANNEL OFF key.
	If syringe is not empty, other possibilities are:	
	• Pressure sensing disc inappropriate/defective. ➤	Verify appropriate pressure sensing disc is in use and functioning properly.
	• Syringe plunger travel impeded. ➤	Verify syringe plunger movement is unimpeded.
• Pressure transducer defective. ➤	If syringe is not empty and above actions do not correct alarm, contact qualified service personnel.	

Alarms (Continued)

Syringe Adjustment Alarms

When a syringe installation problem is detected, a visual signal is displayed. Text in the display blinks to indicate the location of the problem.

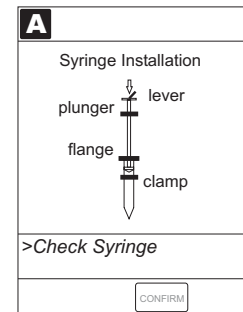

- When problem is corrected, press **CONFIRM** soft key.

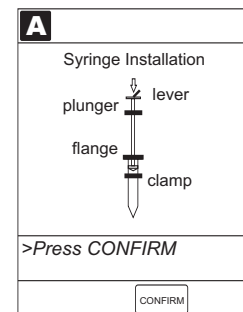

Alarm	Meaning	Response
Check Syringe	Plunger grippers opened during infusion and then closed. Infusion stops on affected channel.	➤ Securely lock plunger grippers, press CHANNEL SELECT key, and reselect syringe.
	Syringe barrel clamp opened during infusion and then closed. Infusion stops on affected channel.	➤ Securely lock syringe barrel clamp and press RESTART key.
	Syringe plunger not captured while in idle state. System alarms after 30 seconds, to indicate potential siphoning condition.	➤ Check for potential siphoning. Ensure administration set clamp (roller/slide) is in closed position. Securely lock plunger grippers over syringe plunger.
Drive Not Engaged	Drive system disengaged during operation.	Open and close plunger grippers and syringe barrel clamp. Ensure syringe is properly installed.

Errors

Error	Meaning	Response
Channel Error	Error detected. Operation stops on affected channel.	To silence alarm and continue operation of unaffected channels, press CONFIRM soft key. Replace channel with an operational instrument, as required. Service by qualified personnel is required.
Syringe Calibration Required	Error on infusing channel indicating calibration is required. Infusion stops on affected channel. CALIBRATE scrolls in Channel Message Display.	To silence alarm and continue operation of unaffected channels, press CONFIRM soft key. Replace channel with an operational instrument, as required. Service by qualified personnel is required.
Syringe Driver Head Error	Noninfusing channel, with plunger grippers open, senses excessive pressure being applied downward on Drive Head. OCCCLUSION scrolls in Channel Message Display.	To silence alarm and continue normal operation, press CONFIRM soft key.

Messages

Message	Meaning	Response
After Call Back	Infusion completed.	Press CONFIRM soft key.
Anesthesia Mode	Anesthesia Mode discontinued when disconnected from AC.	Press CONFIRM soft key.
Bolus Dose Complete	Channel running in continuous infusion mode if programmed.	None
Delay Complete	Delay time completed.	Press RESTART key, or press CHANNEL SELECT key and then START soft key.
Infusion Complete	Current infusion completed.	Set up a new infusion or press CHANNEL OFF key.
Infusion Complete - KVO	Programmed volume-to-be-infused delivered; channel running at KVO rate.	Set up a new infusion or press CHANNEL OFF key.
NEOI (Near End of Infusion)	Syringe almost empty.	None. This is a timed event that can be set. To set or change this option, see "Configurable Settings" section.

Messages (Continued)

Message	Meaning	Response
Panel Locked	Tamper Resist feature is active and a key was pressed.	If appropriate, deactivate Tamper Resist feature using Tamper Resist Control on back of Programming Module.
Panel Unlocked	Tamper Resist feature deactivated.	None.
Pause	Pause control pressed; infusion stopped.	To resume infusion, press RESTART key, or press CHANNEL SELECT key and then START soft key.
Start time for next dose has passed	Start of next dose passed.	Press CONFIRM soft key.
Syringe Not Recognized	Installed syringe of unknown type and size.	Select and confirm correct syringe type and size, and then press CONFIRM ; or use a syringe type and size that system can automatically and correctly identify.

The Medley™ System Technical Service Manual is available from ALARIS Medical Systems. It includes routine service schedules, interconnect diagrams, component parts lists and descriptions, test procedures, and other technical information, to assist qualified service personnel in repair and maintenance of the instrument's repairable components. Maintenance procedures are intended to be performed only by qualified personnel.

Specifications

Bolus Volume following

Occlusion (at intermediate rate):

Without Pressure Sensing Disc:

<u>Pressure Setting</u>	<u>Bolus (g)</u>
Low	0.329
Medium	0.523
High	0.736

With Pressure Sensing Disc:

	<u>Back Off Disabled</u>	<u>Back Off Enabled</u>
300 mmHg	0.277	0.098
500 mmHg	0.416	0.136
1000 mmHg	0.764	0.137

The Medley™ System has a back-off safety feature which, when enabled and a pressure sensing disc is in use, is designed to reduce bolus volume on occlusion release.

WARNING

Installing a pressure sensing disc after an infusion has started can result in a bolus to the patient.

Critical Volume:

The maximum over-infusion which can occur in the event of a single-fault condition will not exceed 2% of nominal syringe fill volume during loading and 1% of maximum syringe travel after syringe loading.

Dimensions:

4.5"W x 15.0"H x 7.5"D

Environmental Conditions:

	<u>Operating</u>	<u>Storage/Transport</u>
<i>Temperature Range:</i>	41 to 104°F (5 to 40°C)	-4 to 140°F (-20 to 60°C)
<i>Relative Humidity:</i> <i>(Avoid prolonged exposure to relative humidity >85%)</i>	20 to 90% Noncondensing	5 to 85% Noncondensing
<i>Atmospheric Pressure:</i>	525 to 4560 mmHg (700 to 6080 hPa)	375 to 760 mmHg (500 to 1013 hPa)

Equipment Orientation:

To ensure proper operation, the Programming Module must remain in an upright position.

Specifications (Continued)

Flow Rate Programming: The flow rate range is from 0.01 to 999 mL/h and can be selected as follows:

<u>Flow Rates (mL)</u>	<u>Selectable Increments (mL/h)</u>
0.01 - 9.99	0.01
10 - 99.9	0.1
100 - 999	1

Rate Restriction by Syringe Size:

<u>Syringe Size (mL)</u>	<u>Flow Rate Range (mL/h)</u>
50/60	0.1 - 999
30	0.1 - 650
20	0.1 - 500
10	0.1 - 250
5	0.1 - 150
3	0.01 - 100
1	0.01 - 30

Fluid Ingress Protection: IPX1, Drip Proof

**Infusion Pressure,
Maximum:**

*Without Pressure
Sensing Disc:*

Approximately 800 mmHg

NOTE: On a high setting, the actual occlusion pressure will vary based on the syringe size and manufacturer.

*With Pressure
Sensing Disc:*

1060 mmHg

KVO (Keep Vein Open) Rate: Factory default setting is 1 mL/h if set rate is 1 mL/h or above; or set rate, if rate is 0.9 mL/h or below.

KVO Selection Range: KVO rate can be set in System Configuration from 0.01-2.5 mL/h in 0.01 mL/h increments.

NOTE: Flow rates as low as 0.01 mL/h are available only with 1cc and 3cc syringes. For larger syringes, the lower limit adjusts to 0.1 mL/h.

Occlusion Alarm Thresholds:

*Without Pressure
Sensing Disc:*

Three settings: Low, Medium, High

*With Pressure
Sensing Disc:*

User selected from 25 to 1000 mmHg in 1 mmHg increments.

Operating Principle: Positive displacement

Specifications (Continued)

Rate Accuracy: Rate accuracy of the Medley™ Syringe Module is $\pm 2\%$ of full scale plunger travel (not including syringe variation).

WARNING

Syringe size and running force, variations of back pressure, or any combination of these may affect rate accuracy. Factors that can influence back pressure are: Administration set configuration, IV solution viscosity, and IV solution temperature. Back pressure may also be affected by type of catheter. Refer to "Trumpet and Start-Up Curves" section in "Appendix" chapter for data on how these factors influence rate accuracy.

Shock Protection: Type CF, Defibrillator Proof

Time to Alarm, Maximum:

Rate (mL/h)	Pressure Limit	
	No Disc High Setting	With Disc Highest (1000 mmHg) Setting
1	120 minutes	105 minutes
5	30 minutes	30 minutes

NOTE: The Maximum Time to Alarm specifications are based on ALARIS Medical Systems' standard operating conditions:

Atmospheric Pressure: 645 - 795 mmHg
Back Pressure: 0 mmHg before producing occlusion
Humidity: 20 - 90%
Temperature: 68 \pm 4°F

Volume to be Infused Programming Increments:

Range (mL)	Increments (mL)
0.1 - 9.99	0.01
10 - 60	0.1

Weight: 4.5 lbs

NOTE: Compliance to Standards

The Medley™ Medication Safety System has been assessed and complies with the following standards: UL 2601-1, including A1 and A2; CSA C22.2 No. 601.1, including A1 and A2; IEC/EN 60601-2-24; IEC/EN 60601-1-2, and AAMI ID26.

Configurable Settings

If the configuration settings need to be changed from the "Factory Default" settings, refer to the applicable Technical Service Manual or contact ALARIS Medical Systems, Technical Support, for technical, troubleshooting, and preventive maintenance information.

NOTE: With the Profiles feature enabled, the settings are configured independently for each profile. A hospital-defined, best-practice data set must be uploaded to enable the Profiles feature. Date and Time is a system setting and is the same in all profiles.

System Settings

Refer to the Medley™ Programming Module Directions for Use.

Shared Infusion Settings (Pump Module and Syringe Module)

Feature	Default Setting	Options
ALL Mode	Disabled	Enabled - Disabled
Delay Options	Disabled	Enabled - Disabled
• Callback	None	None, Before, After, Before and After
Drug Calculation	Disabled	Enabled - Disabled
• Bolus Dose	Disabled	Enabled - Disabled
Multidose	Disabled	Enabled - Disabled
• Callback	None	None, Before, After, Before and After
NEOI	Disabled	Enabled - Disabled
• Alert Time	60	1 - 60 minutes or 25% of remaining infusion time, whichever comes later
Pressure Dynamic (“Dynamic Pressure Display”)	Disabled	Enabled - Disabled
Priming	Disabled	Enabled - Disabled
Volume/Duration	Disabled	Enabled - Disabled

Configurable Settings (Continued)

Syringe Module Settings

Feature	Default Setting	Options
Auto Pressure	Disabled	Enabled - Disabled
Back Off After Occlusion	Enabled	Enabled - Disabled
Fast Start	Enabled	Enabled - Disabled
KVO (“Keep Vein Open”)	Disabled	Enabled - Disabled
• Rate Adjust	1 mL/h	0.1 - 2.5 mL/h
• Volume Adjust	5%	0.5 - 5%
Max Rate	999 mL/h	0.1 - 99.9 mL/h in 0.1 mL/h increments; 100 - 999 mL/h in 1 mL/h increments
Occlusion Pressure Set Point:		
• With Disc	1000 mmHg	25 - 1000 mmHg in 1 mmHg increments
• No Disc	High	Low, Medium, High

Compatible Syringes

The MEDLEY™ Syringe Module is calibrated and labeled for use with the following single-use disposable luer-lock syringes. Use only the syringe size and type specified on the Main Display. The full list of permitted syringe models is dependent on the Syringe Module’s software version.

CAUTION

When using a 10cc or smaller syringe, ALARIS Medical Systems strongly recommends using an extension set with a pressure disc, for improved pressure monitoring and shorter times to occlusion alarm.

Manufacturer	1cc	3cc	5cc	6cc	10cc	12cc	20cc	30cc	35cc	50cc	60cc
AstraZeneca										✗ ¹	✗ ¹
B-D Plastipak	✗	✗	✗		✗		✗	✗		✗	✗
IVAC										✗	
Monoject		✗ ²		✗		✗	✗		✗		✗
Terumo		✗	✗ ³		✗ ³		✗	✗		✗	✗

¹ Prefilled Diprivan.

² The Monoject SoftPack Luer-Lock Syringe (blister pack) is the only currently supported Monoject 3cc.

³ The Terumo 5cc doubles as a 6cc and the 10cc doubles as a 12cc.

Cleaning

Refer to the Medley™ Programming Module Directions for Use.

Inspection Requirements

To ensure the system remains in good operating condition, both regular and periodic inspections are required.

Regular inspections consist of a visual inspection for damage and cleanliness, and performing the procedure described in the “Start-Up” section of this Directions for Use before each usage of the instrument. Regular inspections must be performed by the hospital/facility and if any damage is found, service is required.

WARNING

Failure to perform these inspections may result in improper instrument operation.

REGULAR INSPECTIONS

PROCEDURE	FREQUENCY
INSPECT FOR DAMAGE:	
Exterior Surfaces	Each usage
Keypad	Each usage
Mechanical Parts	Each usage
CLEANING	As required
START-UP	Each usage

1. Exterior Surfaces - examine for overall condition and verify:
 - No damage, cracks or deformities.
 - Case is clean and free from IV solution residue, especially near moving parts.
 - Labels and markings are legible.
 - No tape or other foreign material is on sides of case; anything of this nature could prevent proper latching of channels.
 - IUI Connectors have not been damaged.
2. Keypad
Check membrane switches for damage.
3. Mechanical Parts
Ensure mechanical parts move freely, do not hang up or bind, and function properly.

Periodic inspections of the hardware are required. For detailed instructions on performing periodic inspections and maintenance, refer to the Medley™ Technical Service Manual and supplemental service bulletins, and Medley™ Maintenance Software User Manual.

CAUTION

Periodic inspections should only be performed by qualified service personnel.

Service Information

Refer to the Medley™ Programming Module Directions for Use.

WARRANTY

ALARIS Medical Systems, Inc., (hereinafter referred to as "ALARIS Medical Systems") warrants that:

- A. Each new ALARIS Medical Systems® Medley™ Syringe Module is free from defects in material and workmanship under normal use and service for a period of one (1) year from the date of delivery by ALARIS Medical Systems to the original purchaser.
- B. Each new accessory is free from defects in material and workmanship under normal use and service for a period of ninety (90) days from the date of delivery by ALARIS Medical Systems to the original purchaser.

If any product requires service during the applicable warranty period, the purchaser should communicate directly with the relevant account representative to determine the appropriate repair facility. Except as provided otherwise in this warranty, repair or replacement will be carried out at ALARIS Medical Systems' expense. The product requiring service should be returned promptly, properly packaged and postage prepaid by purchaser. Loss or damage in return shipment to the repair facility shall be at purchaser's risk.

In no event shall ALARIS Medical Systems be liable for any incidental, indirect or consequential damages in connection with the purchase or use of any ALARIS Medical Systems® Product. This warranty shall apply solely to the original purchaser. This warranty shall not apply to any subsequent owner or holder of the product. Furthermore, this warranty shall not apply to, and ALARIS Medical Systems shall not be responsible for, any loss or damage arising in connection with the purchase or use of any ALARIS Medical Systems® Product which has been:

- (a) repaired by anyone other than an authorized ALARIS Medical Systems Service Representative;
- (b) altered in any way so as to affect, in ALARIS Medical Systems' judgment, the product's stability or reliability;
- (c) subjected to misuse or negligence or accident, or which has had the product's serial or lot number altered, effaced or removed;

or

- (d) improperly maintained or used in any manner other than in accordance with the written instructions furnished by ALARIS Medical Systems.

This warranty is in lieu of all other warranties, express or implied, and of all other obligations or liabilities of ALARIS Medical Systems, and ALARIS Medical Systems does not give or grant, directly or indirectly, the authority to any representative or other person to assume on behalf of ALARIS Medical Systems any other liability in connection with the sale or use of ALARIS Medical Systems® Products.

ALARIS MEDICAL SYSTEMS DISCLAIMS ALL OTHER WARRANTIES, EXPRESS OR IMPLIED, INCLUDING ANY WARRANTY OF MERCHANTABILITY OR OF FITNESS FOR A PARTICULAR PURPOSE OR APPLICATION.

See packing inserts for international warranty, if applicable.

THIS PAGE
INTENTIONALLY
LEFT BLANK

Trumpet and Start-Up Curves

In this instrument, as with all infusion systems, the action of the pumping mechanism and variations in individual syringes and administration sets cause short-term fluctuations in rate accuracy. The following graphs show typical performance of the system, as follows:

1. Accuracy during various time periods over which fluid delivery is measured (trumpet curves).
2. Delay in onset of fluid flow when infusion commences (start-up curves).

Trumpet and start-up curves have been provided for 1.0 mL/h and 5.0 mL/h. Measurements for trumpet curve rates below 1.0 mL/h are not provided because of the difficulty in measuring extremely small volumes over a large duration of time. In this case, the linear relationship of the plunger position and velocity to syringe volume and rate is verified, and is a function of the accuracy of the design. Measurements for trumpet curve rates above 5.0 mL/h are also not provided, as the volume of the syringe will be displaced in a very short time with a rate of up to 999 mL/h. Accuracy, however, is assured with the design implementation.

Trumpet curves are named for their characteristic shape. They display discrete accuracy data averaged over particular time periods or "observation windows", not continuous data versus operating time.

Over long observation windows, short-term fluctuations have little effect on accuracy, as represented by the flat part of the curve. As the observation window is reduced, short-term fluctuations have greater effect, as represented by the "mouth" of the trumpet. Knowledge of system accuracy over various observation windows may be of interest when certain drugs are being administered.

Because the clinical impact of short-term fluctuations on rate accuracy depends on the half-life of the drug being infused and on the degree of intravascular integration, the clinical effect cannot be determined from the trumpet curves alone. Knowledge of the start-up characteristics should also be considered.

The start-up curves represent continuous flow rate versus operating time for two hours from the start of the infusion. They exhibit the delay in onset of delivery due to mechanical compliance and provide a visual representation of uniformity. Trumpet curves are derived from the second hour of this data.

Under conditions of -100 mmHg, +100 mmHg, and +300 mmHg pressures, the Medley™ Syringe Module typically exhibits a long-term accuracy offset of approximately 0.2% or less from the mean value.

NOTE: Tests conducted in accordance with IEC/EN 60601-2-24, "Particular requirements for safety of infusion pumps and controllers" and AAMI ID26-1998 "Medical electrical equipment - Part 2: Particular requirements for the safety of infusion pumps and controllers", using B-D Plastipak 60cc Syringe and ALARIS Medical Systems® Administration Set (30910).

Trumpet and Start-Up Curves (Continued)

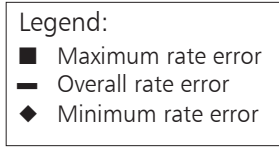
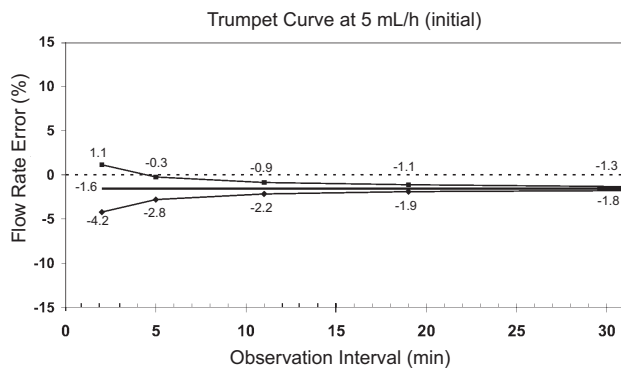
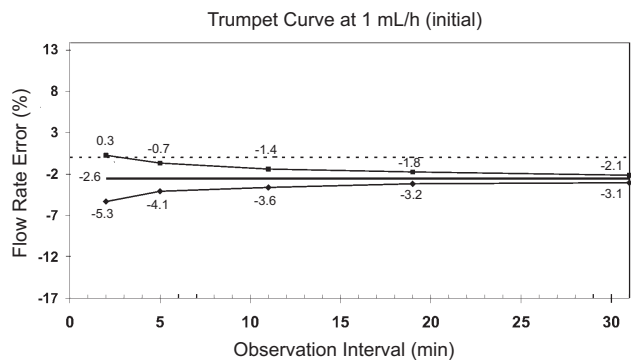
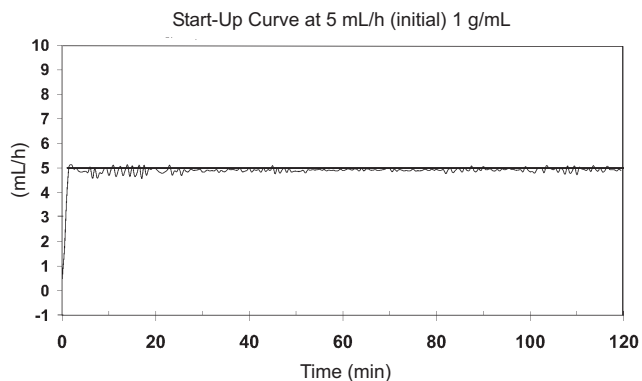
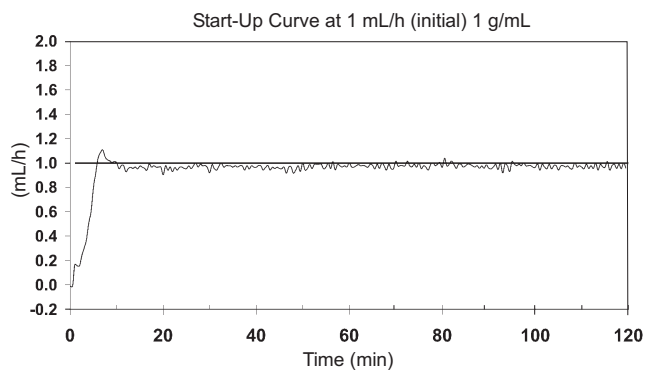

ALARIS[®]

MEDICAL SYSTEMS

ALARIS Medical Systems, Inc.
10221 Wateridge Circle
San Diego, California 92121 U.S.A.

Mail:
P.O. Box 85335
San Diego, California 92186-5335 U.S.A.

ALARIS[®], ALARIS Medical Systems[®], Guardrails[®], and Medley[™] are trademarks and registered trademarks of ALARIS Medical Systems, Inc.
All other trademarks belong to their respective owners.

US Pat. Nos. 5,601,445; 5,713,856; 5,836,910; 5,941,846; AU Patent Nos. 693,662; 703,178; 703,203; 728,366; TW Patent No. NI-107963. Other Patents Pending