

MedSystem III[®] Infusion Pump Model 2865

With Advanced Dose Rate Calculation and Drug List Editor

User Manual

November 2012
Material Number: 12275767

carefusion.com



CareFusion, MedSystem III, and the CareFusion logo are trademarks or registered trademarks of CareFusion Corporation or one of its subsidiaries.

All other trademarks are the property of their respective owners.

CareFusion Corporation
San Diego, CA
United States
800.367.9947
carefusion.com

© 2012

CareFusion Corporation
or one of its subsidiaries

All rights reserved.

MedSystem III® Infusion Pump Model 2865

Changes in equipment, software, or procedures occur periodically; information describing these changes will be included in future editions of the guide.

The information in this document is subject to change and does not represent a commitment on the part of CareFusion to provide additional services or enhancements.

Documentation provided with this product might reference product not present in your facility or not yet available for sale in your area.

This manual provides information on current Standards for Electromagnetic Compatibility by IEC EN 60601-1-2-2002 a Collateral Standard for Electromagnetic Compatibility information found in the applicable User Manual for each MedSystem III infusion system. Also, hyperbaric chamber operations cautions are provided.

Customer Advocacy - North America

(Clinical and technical feedback.)

Phone: 888.876.4287

E-mail: customerfeedback@carefusion.com

Technical Support - North America

(Maintenance and service information support; troubleshooting.)

Phone, United States: 888.876.4287

Phone, Canada: 800.387.8309

E-mail: DL-US-INF-TECH-SUPPORT@carefusion.com

Customer Order Management - North America

(Product return, service assistance, and order placement.)

Phone, United States: 800-482-4822

Phone, Canada: 800.387.8309

E-mail: custcareinfusion@carefusion.com

Contents

Chapter 1—Introduction

| | |
|--|----------|
| About the MedSystem III® Infusion Pump | 1 |
| Contraindications..... | 3 |
| Features | 3 |
| Multi-channel Fluid Delivery System | 3 |
| Lightweight/portable..... | 3 |
| Unique, rotating pole clamp | 3 |
| Dose Rate Calculator (DRC)..... | 4 |
| Drug List Editor (DLE) | 4 |
| Six Device Types available | 4 |
| Free-flow Protection..... | 4 |
| Monitoring System | 5 |
| Field Maintenance Software (FMS)..... | 5 |
| Secondary Mode | 5 |
| Syringe Delivery..... | 5 |
| Full Range of Delivery Rates | 5 |
| Battery Capacity | 5 |
| System Components | 6 |
| Front Panel..... | 6 |
| Lower Assembly..... | 7 |
| Connector Panel..... | 7 |
| Pole Clamp | 8 |
| Symbols..... | 9 |

Chapter 2—Getting Started

| | |
|---|----|
| Warnings and Cautions..... | 11 |
| Prepare for Infusion..... | 18 |
| To prepare infusion..... | 18 |
| Prepare the Administration Set..... | 18 |
| To prepare the Administration Set..... | 18 |
| Load the Set..... | 19 |
| To load the set..... | 19 |
| Front Panel Overview..... | 21 |
| Programming Page..... | 22 |
| The Programming Page..... | 23 |
| Turn the Pump On and Off..... | 23 |
| View Infusion Settings for All Active Channels..... | 23 |
| Activate Additional Standard Display Softkey Prompts..... | 23 |
| Select Channel and Display..... | 24 |
| Program an Infusion..... | 24 |
| Access Alarm Information..... | 25 |
| Activate Additional Softkeys..... | 25 |
| Program Primary Functions..... | 25 |
| Making Changes While Infusing..... | 28 |
| Programming Options..... | 29 |
| KVO Status..... | 30 |
| Secondary Mode..... | 32 |
| Dose Rate Calculator Programming with DRUG?..... | 40 |
| Facts about Dose Rate Calculator..... | 42 |
| Device..... | 43 |
| Config (Configuration)..... | 47 |
| Note Softkey..... | 48 |
| BatLog (Battery History Log)..... | 48 |

Chapter 3—Alarms, Advisories, and Prompts

| | |
|--------------------------|----|
| Alarm Response Keys..... | 52 |
| Advisories..... | 53 |
| Alarms..... | 54 |
| Fault..... | 58 |
| Watchdog..... | 58 |

Chapter 4—Maintenance

| | |
|-----------------------------|----|
| Specifications..... | 61 |
| AC Adapter Model 1565C..... | 63 |
| Check-In..... | 64 |
| Physical Inspection..... | 64 |
| Functional Test..... | 64 |
| Check-In Tests..... | 65 |
| Electrical Safety Test..... | 65 |
| Power Tests..... | 66 |

| | |
|--|-----------|
| New Instrument Volume Accuracy Test | 69 |
| Cleaning..... | 72 |
| Cleaning Solutions..... | 72 |
| Inspection Requirements | 78 |
| Service Information..... | 78 |
| Technical Support..... | 79 |
| Warranty | 80 |
| Trumpet and Start-Up Curves | 81 |
| Flow Characteristics under Varying Delivery Conditions | 82 |
| Effects of Pressure Variations..... | 82 |
| Effects of Negative Solution Container Heights..... | 82 |
| Pressure Mode | 82 |
| Electromagnetic Environment..... | 84 |
| FCC Notice..... | 84 |
| Canadian Notice (Avis Canadien)..... | 84 |
| EMC Tables..... | 85 |
| Standards | 90 |
| Glossary | 91 |

- Notes -

Chapter 1

Introduction

About the MedSystem III[®] Infusion Pump

The MedSystem III[®] infusion pump with Drug List Editor is intended for use in today's growing professional healthcare environment, including healthcare facilities and home care, for use on adults, pediatrics and neonates.

The MedSystem III is intended for facilities that utilize infusion pumps for the delivery of fluids, medications, blood and blood products using continuous or intermittent delivery through clinically acceptable routes of administration; such as, intravenous (IV), intra-arterial (IA), subcutaneous, epidural, enteral, or irrigation of fluid spaces.

The MedSystem III is a multi-channel infusion pump intended to deliver multiple infusions to a single patient.

MedSystem III with Drug List Editor features:

- Three independent fluid delivery systems in the space of one.
- Compact size:
 - reduces bedside clutter
 - simplifies patient transport
- Easy to Setup and use, yet provides advanced features.
- Accommodates assorted container types.
- Multiple delivery methods:
 - Intravenous/Intra-arterial/Subcutaneous/Epidural
- Accurate delivery of a variety of fluids.
- Uses administration sets that provide free-flow protection.
- Six available Device Types with configurable parameters (maximum and minimum rates, maximum volumes, baseline and maximum pressures, and air-in-line thresholds) to achieve specific clinical applications:
 - General Purpose
 - Neonatal
 - Controller Pressure
 - Operating Room
 - General Purpose II
 - Operating Room II
- Display infusion status for rate, volume remaining and volume infused.
- Infusions can be programmed to deliver at a specified rate or over a specified period of time.
- Secondary mode allows fluids and medications to be delivered at two different rates, sequentially.
- Dose Rate Calculator (DRC) feature performs volumetric rate and/or dose rate calculations.
- With DRC activated, the MedSystem III displays infusion status for rate, dosing regimen and drug name.
- Communications Protocol allows clinical monitoring, MedSystem III configuration and maintenance.
- Field Maintenance Software (FMS) available for Biomed to configure, service and troubleshoot the MedSystem III.

Contraindications

None known.

Features

Multi-channel Fluid Delivery System

Combines three independent infusion channels in an unparalleled small size.

Lightweight/portable

The MedSystem III with pole clamp weighs just over 5 pounds (2.3kg) and is easy to transport.

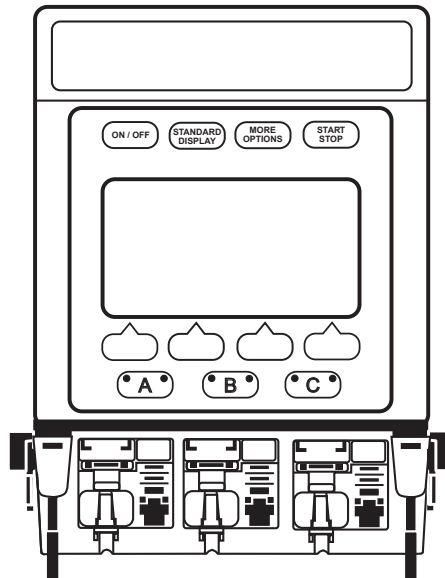

Unique, rotating pole clamp

Can be attached to a variety of surfaces.

Dose Rate Calculator (DRC)

Calculates a volumetric or dose rate based on values entered for patient weight, drug concentration (drug amount and diluent volume) and dosing parameters.

| | |
|-----------------------------|-------------------|
| A: Stopped | |
| DRUG? | Wt --- KG= 0.0 LB |
| A:Conc ----- | mg/--- ml |
| A:Dose ----- | mcg/kg/min |
| A:Rate ----- | ml/h |
| A:VR 1 | ml (Vol Rem) |
| A:VI 0 ml DI | 0.0 mg |
| Press Select to choose line | |
| Select | ↑ ↓ Clear |

Drug List Editor (DLE)

Drug list can be customized using Drug List Editor software.

Six Device Types available

Six available Device Types with configurable parameters (maximum and minimum rates, maximum volumes, baseline and maximum pressures, and air-in-line thresholds) to achieve specific clinical applications:

| | |
|---------------------|-------------------|
| General Purpose | Neonatal |
| Controller Pressure | Operating Room |
| General Purpose II | Operating Room II |

Free-flow Protection

Administration Sets contain a cassette that provides protection from free-flow conditions. Upon removal of the cassette from the MedSystem III, the cassette's slide clamp is pulled to full extension, occluding the tubing and preventing fluid from flowing.

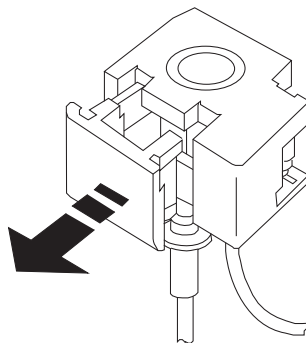

Monitoring System

The monitoring system can continuously monitor the MedSystem III conditions and alerts with adjustable audio tones and visual messages.

Field Maintenance Software (FMS)

Can be modified to accommodate specialized clinical applications. The Device Type parameters, occlusion limit, and air-in-line threshold can be configured with the FMS software.

Secondary Mode

Allows user to program two different rates of infusion to run sequentially.

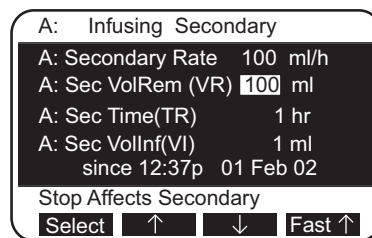

Syringe Delivery

Accommodates 20cc to 60cc syringes.

Full Range of Delivery Rates

Rates from 0.1 to 999 milliliters per hour.

Battery Capacity

A new fully-charged battery provides 6 hours of operating time with rates at 125 ml/h per channel.

System Components

Front Panel

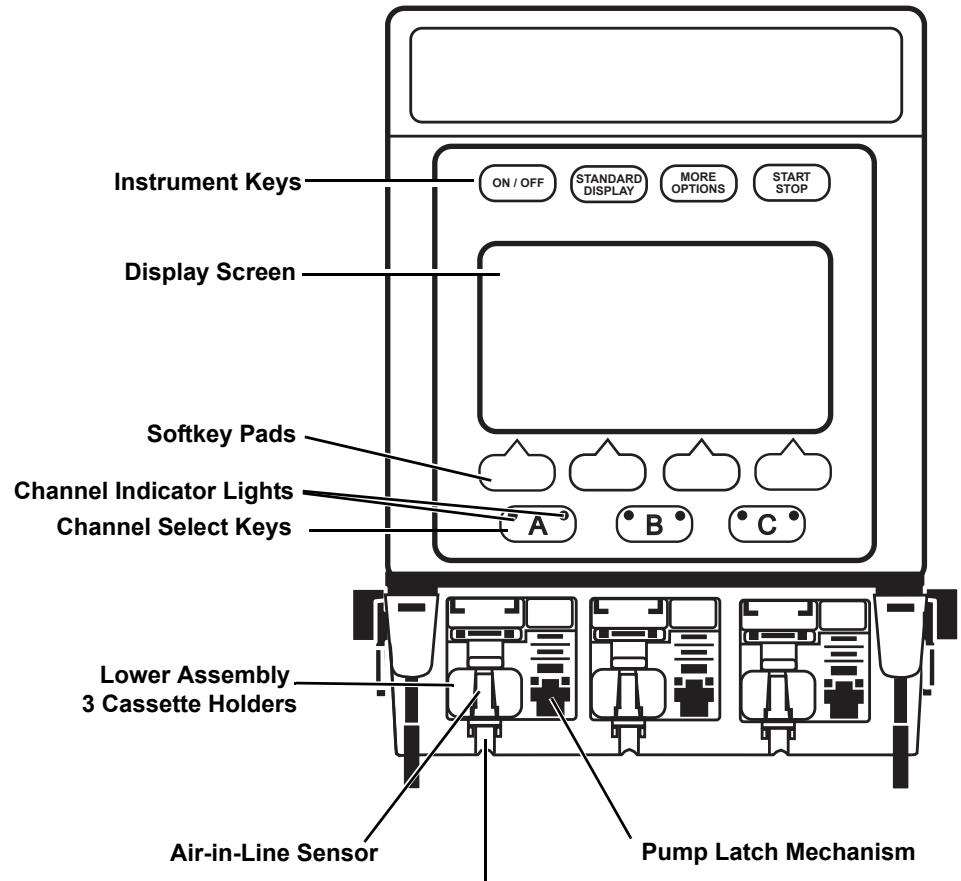

Cassette
Portion of administration set
inserts into cassette holder

Tubing Collar Recess

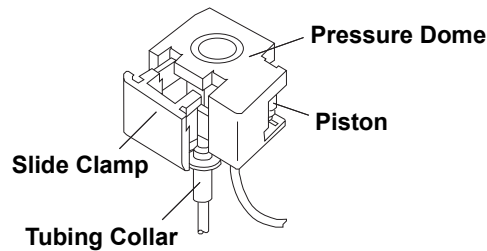

Channel Indicators Lights—Green

- Steady-AC power
- Flashing- battery power

Channel Indicators Lights—Red

- Slow flashing - Advisory
- Rapid Flashing - Alert

Lower Assembly

Air-in Line Sensor—detects bubbles of air during infusion

Tubing Collar Recess—holds tubing collar in place.

Pump Latch Mechanism—drives the cassette piston to move fluid through the tubing.

Connector Panel

CAUTION

When inserting or removing the connectors into or from the receptacles, avoid excessive force or twisting. To remove the AC adapter from the pump first remove the clip that is on the connector.

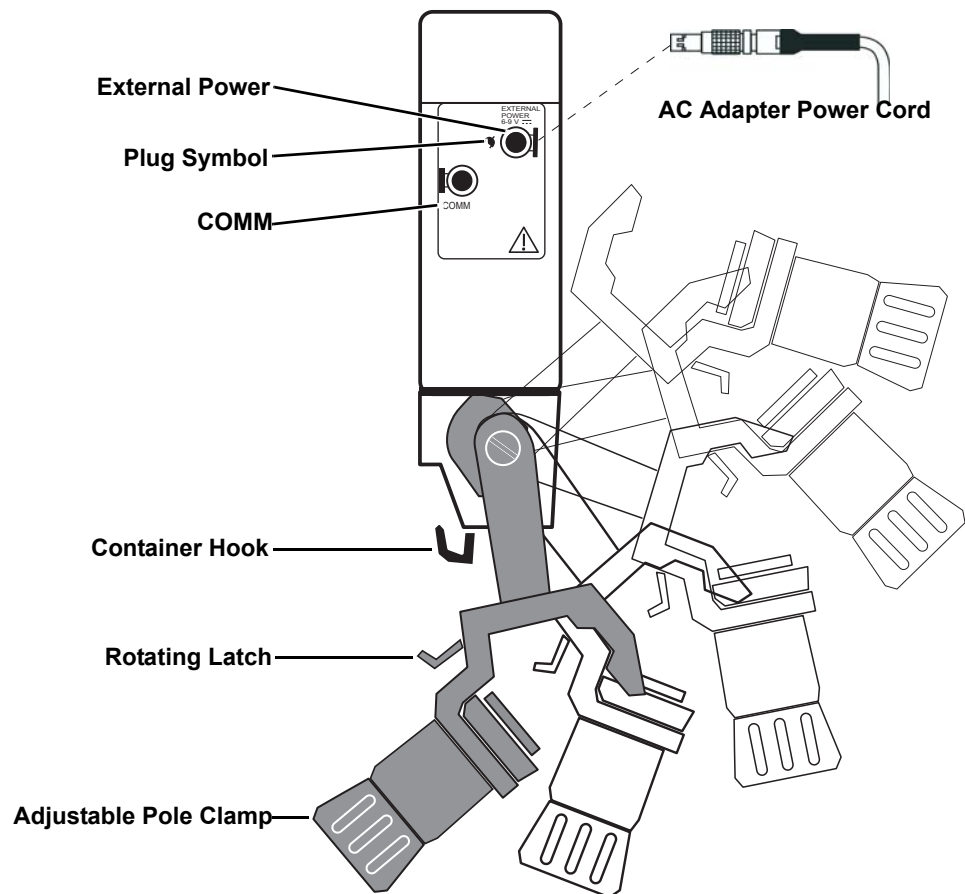

External Power—external power receptacle connects with the power cord.

Plug Symbol—green light on indicates AC power is connected; batteries are charging.

COMM—communications line receptacle connects with RS-232.

Container Hook—one hook on each side of the MedSystem III.

Rotating Latch—allows clamp to spin 360° and position at every 90°.

Adjustable Pole Clamp—jaw with clutch feature, mounts pump to a pole or bedside.

NOTE

The MedSystem III is designed to function in any orientation. However, the effectiveness of the administration set air trap is diminished when the MedSystem III is not in the vertical position.

Pole Clamp

To attach pole clamp

1. Position the clamp jaw over mounting surface and turn the knob until the clamp is tightened and the pump feels secure.
2. When knob is as tight as possible, continued turning makes the knob click and spin freely without over-tightening.

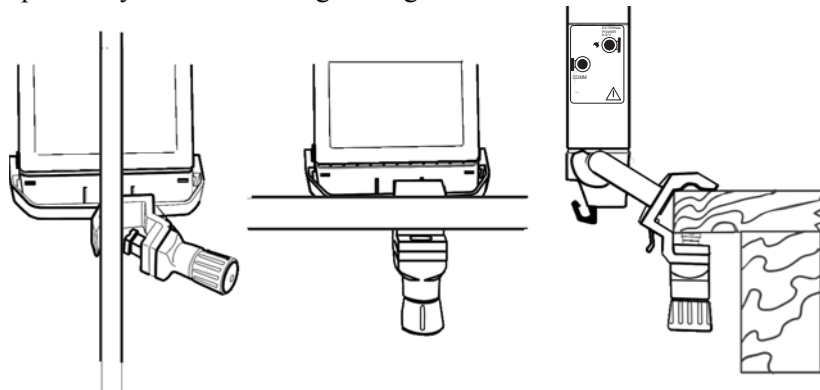



When knob is as tight as possible, continued turning makes the knob click and spin freely without over-tightening.

Symbols

 Canadian and U.S. Certification Mark: Products bearing this mark have been tested and certified in accordance with applicable U.S. and Canadian electrical safety and performance standards.

IPX1 Protection against fluid ingress: Drip Proof.

 Caution: Refer to accompanying documentation.

 U.S. Certification Mark: Products bearing this mark have been tested and certified in accordance with applicable U.S. electrical safety and performance standards (UL544).

 Manufacturing Date: Number adjacent to symbol indicates month and year of manufacture.

 Consult operating instructions.

 Explosion risk if used in presence of flammable anesthetics

Rx Only Caution: Federal (U.S.A.) law restricts this device to sale by or on order of a physician.

Single-Use
 Single-Use. Do not reuse.

 DEHP in fluid pathway.

 No DEHP in fluid pathway.

 Product is latex-free.

 Product incorporates SmartSite Needle-Free Valve ports and should not be accessed by a needle.

Approximate administration set, priming volume.
]=xx ml=[



Drops per milliliter specification for product will be identified on drop symbol.



Expiration date for product will be identified near hour glass symbol.

Chapter 2

Getting Started

NOTE

Although the MedSystem III is built and tested to exacting specifications, it is not intended to replace the supervision of IV infusions by medical personnel. The user should become thoroughly familiar with the features and operation of the MedSystem III and exercise vigilance in its use.

Warnings and Cautions

WARNING

A Warning is an alert to a potential hazard which could result in serious personal injury and/or product damage if the proper procedures are not followed.

CAUTION

A Caution is an alert to a potential hazard which could result in minor personal injury, loss of data, and/or product damage if the proper procedures are not followed.

WARNING

The use of any accessory, transducer, or cable with the MedSystem III other than those specified may result in increased emissions or decreased immunity or electromagnetic compatibility performance of the MedSystem III.

WARNING

Only connect equipment approved to IEC EN 60601-1 or UL 1069 approved medical or hospital signaling equipment.

WARNING

Epidural administration of drugs other than those indicated for epidural use could result in serious injury to the patient.

WARNING

The MedSystem III, source container and Administration Set used for epidural drug delivery must be clearly differentiated from those used for other types of administration.

WARNING

The MedSystem III is designed to stop fluid flow under alarm conditions other than Low Battery and KVO. Periodic patient monitoring must be performed to ensure the infusion is proceeding as expected.

WARNING

The MedSystem III is a positive pressure delivery system, capable of developing positive fluid pressures to overcome widely varying resistances to flow encountered in practice, including resistances to flow imposed by small gauge catheters, filters and intra-arterial infusion. It is neither designed nor intended to detect infiltrations and will not alarm under infiltration conditions.

WARNING

Hospital personnel must ensure compatibility of drugs as well as performance of each channel as part of the overall infusion. Potential hazards include drug interactions, inaccurate delivery rates, inaccurate pressure alarms and nuisance alarms.

WARNING

Use only MedSystem III administration sets. MS III administration sets are dedicated for use with the MedSystem III infusion pump. The use of any other administration set may cause improper MedSystem III operation, resulting in an inaccurate fluid delivery or other potential hazard.

WARNING

The use of positive displacement infusion devices ported together with gravity flow infusion systems into a common IV site may impede the flow of common gravity only systems, affecting their performance. Hospital personnel must ensure performance of common IV site is satisfactory under these circumstances.

WARNING

References in this document to specific drugs and drug doses are for example only. Refer to specific drug product labeling for information concerning appropriate administration techniques and dosages.

WARNING

Use of accessories or cables other than those specified may result in degraded electromagnetic compatibility performance of the MedSystem III.

WARNING

Do not use the MedSystem III infusion pump near Magnetic Resonance Imaging (MRI), including Sterotaxis technology.

WARNING

Do not use the MedSystem III infusion pump near Magnetic Resonance Imaging (MRI), including Sterotaxis technology.

WARNING

Do not use the MedSystem III infusion pump near Therapeutic Radiation equipment such as Linear Accelerators.

WARNING

Use of any accessory, transducer or cable other than those specified may result in increased emissions or decreased MedSystem III immunity.

WARNING

Read all instructions before using the MedSystem III infusion system.

CAUTION

- **Hyperbaric Chamber Operation:**

The MedSystem III Infusion System is not certified for use in oxygen enriched environments

Your healthcare facility's hyperbaric safety director is responsible for all equipment used in the hyperbaric chamber environment.
- A dropped or severely jarred device or accessory should be immediately taken out of use and inspected by qualified service personnel to ensure its proper function prior to reuse.
- If the MedSystem III appears damaged, contact CareFusion for authorization to return it for repair.

To ensure proper performance of the MedSystem III and to reduce potential injury, observe the following precautions:

Epidural Administration

The MedSystem III can be used for epidural administration of anesthetic and analgesic drugs. This application is only appropriate when using analgesics and anesthetics labeled for continuous epidural administration and catheters intended specifically for epidural use. Use only a MedSystem III administration set, without a Y connector or injection port, for epidural infusions.

- Epidural administration of anesthetic drugs: Use indwelling catheters specifically indicated for short term (96 hours or less) anesthetic epidural drug delivery.
- Epidural administration of analgesic drugs: Use indwelling catheters specifically indicated for either short term or long term analgesic epidural drug delivery.

Parallel Infusions

There are no contraindications regarding the use of a MedSystem III with any other positive displacement infusion device when ported together into a common IV site location.

To ensure proper MedSystem III performance and to reduce potential injury to the operator, observe the following precautions:

- Disconnect from mains (AC) and battery power when performing maintenance.
- To disconnect AC power, unplug power cord from back of the MedSystem III.
- Do not open the MedSystem III case. There are no user serviceable parts inside. The case should only be opened by qualified service personnel using proper grounding techniques. When the case is opened, an electrical shock

hazard exists which can result in serious injury to persons and MedSystem III component damage.

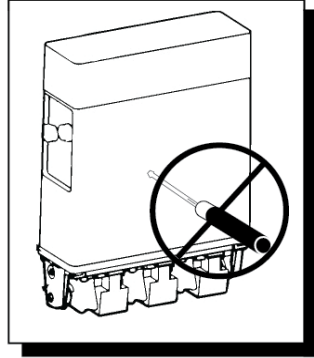

Administration Sets

- A list of approved IV sets recommended by CareFusion, for use with the MedSystem III is listed on the Set Compatibility Card. The use of any other set may cause improper MedSystem III operation, resulting in inaccurate fluid delivery.
- Before operating the MedSystem III, verify that the administration set is free from kinks and installed correctly.
- The MedSystem III administration sets are disposable, have a sterile fluid path and are intended only for one time use. Do not re sterilize.
- Always power on the MedSystem III before inserting the set.
- Do not insert a cassette into a channel with a SERVICE prompt.
- Remove any cassettes from channel(s) requiring service.
- Ensure the cassette is properly installed before starting infusions.
- For set replacement interval, refer to facility protocol and/or government standards (such as CDC guidelines in the United States).
- For IV push medication (put Instrument on hold), clamp tubing above the port.
- Flush port(s) per facility protocol.
- Discard administration set per facility protocol.

Artifacts

It is normal for an infusion device to produce nonhazardous currents when infusing electrolytes. These currents vary proportional to the infusion device flow rate. When the ECG monitoring system is not functioning under optimal conditions, these currents may appear as artifacts, simulating actual ECG readings. To determine if ECG abnormalities are caused by patient condition or the ECG equipment, place the infusion device on hold. If the ECG readings become normal, the ECG equipment requires attention. Proper setup of the ECG equipment should eliminate these artifacts. Reference the appropriate ECG monitoring system documentation for instructions on setup and maintenance.



Dropping/Jarring

Should an instrument be dropped or severely jarred, it should be immediately taken out of use and inspected by qualified service personnel, to ensure its proper function prior to reuse.

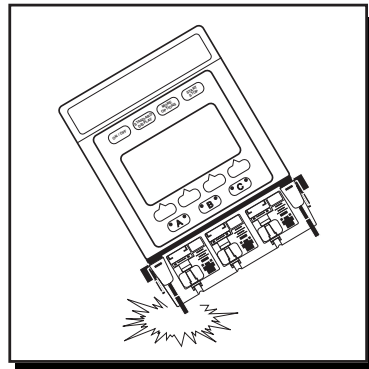

Operating Environment

Do not use the MedSystem III in the presence of flammable anesthetics.



Radio Frequency Interference

- This equipment system is intended for use by healthcare professionals only. This is a CISPR 11 Class B Group 2 Medical equipment system. In a domestic environment this equipment or system may cause radio interference, in which case it may be necessary to take adequate mitigation measures, such as re-orienting, relocating or shielding instrument or filtering the connection to the public mains network.
- Medical Electrical Equipment needs special precautions regarding EMC and needs to be installed, put into service and used according to the EMC information provided in the accompanying documents.
- Portable and Mobile RF communications can affect Medical Electrical Equipment.
- Operating the system near equipment which radiates high energy radio frequencies (electrosurgical/cauterizing equipment, portable radios, cellular telephones, and so on.) may cause false alarm conditions. If this happens, reposition the device away from the source of interference or turn off the device and manually regulate the flow with the clamp and/or monitor the vital parameters using an appropriate clinical alternative.

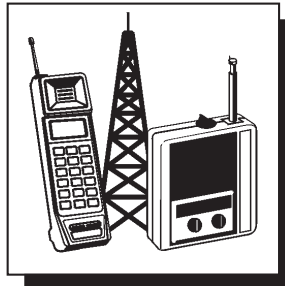

Other Precautions

- The AC adapter must be connected to a properly grounded, 3-wire receptacle (Hospital Use or Hospital Grade).
- Avoid excessive force or twisting of detachable power cords when inserting or removing connector terminals.
- Use AC adapter indoors only.
- Instruments should not be used adjacent to or stacked with other equipment, if adjacent or stacked use is necessary, instrument should be observed to verify normal operation in the configuration used.

Prepare for Infusion

Prepare solution container in accordance with the manufacturer's instructions.

- A syringe can be used as the container for the IV fluid to be infused. Syringe sizes from 20cc to 60cc such as the B-D and Monoject brands can be used.

To prepare infusion

1. Connect the container to the IV set.
2. Prime the MedSystem III administration set in accordance with the Administration Set User Manual.

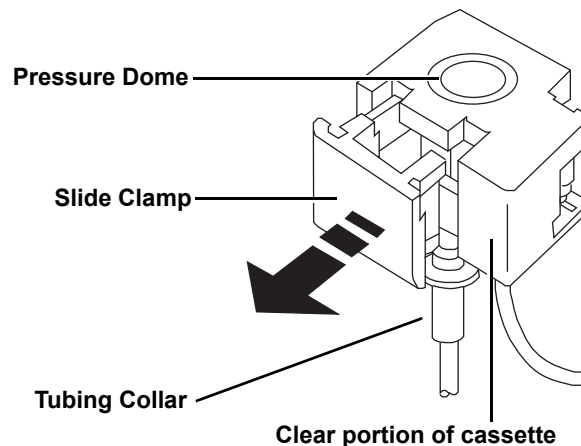

WARNING

It is important to prime the set properly to eliminate air bubbles.

NOTE

The Model 8631A Syringe Holder is available as an accessory that provides a convenient place to hold syringes while they are being used as containers for IV fluid. The Syringe Holder is designed to be easily installed and removed from the top of the pump and to support up to three syringes. Do not use the Syringe Holder as a handle to carry the pump.

Prepare the Administration Set

To prepare the Administration Set

1. Ensure that the cassette slide clamp is pushed in completely so that the tubing is not occluded.
2. Invert the cassette so tubing is up.
3. Slowly open the regulating clamp and establish fluid flow to fully prime the set. Gently tap the cassette and Y sites as necessary to remove all air.
4. Gently massage the pressure dome to ensure no air bubbles are trapped.

-
5. Close the regulating clamp before inserting and removing the cassette to reduce the risk of free flow.

WARNING

An open regulating clamp and slide clamp can cause a free-flow condition and might result in serious injury to the patient.

Load the Set

To load the set

1. Ensure that the cassette slide clamp is pulled out and in the closed position prior to loading.

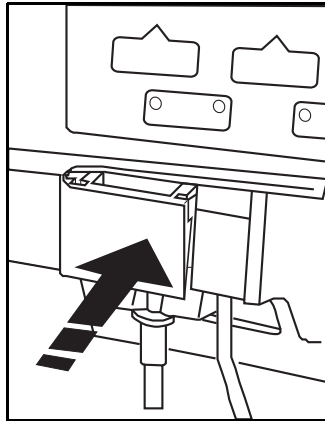

2. Press **ON/OFF** to turn the pump on.
3. With the tubing down, use a 45-degree upward motion to insert the cassette into the channel.
4. Push on the clear portion of cassette until completely seated.
5. Push in slide clamp flush with entire cassette.

6. Pull down gently on tubing collar. Press with thumb to seat tubing collar in recess beneath cassette.

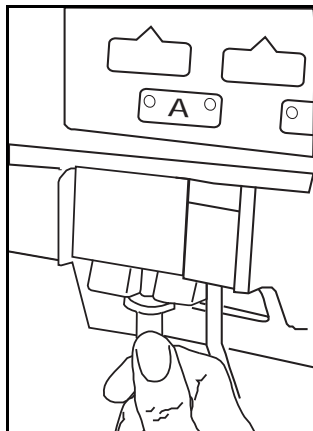

NOTE

Three beeps sound when the set is properly loaded.

Front Panel Overview

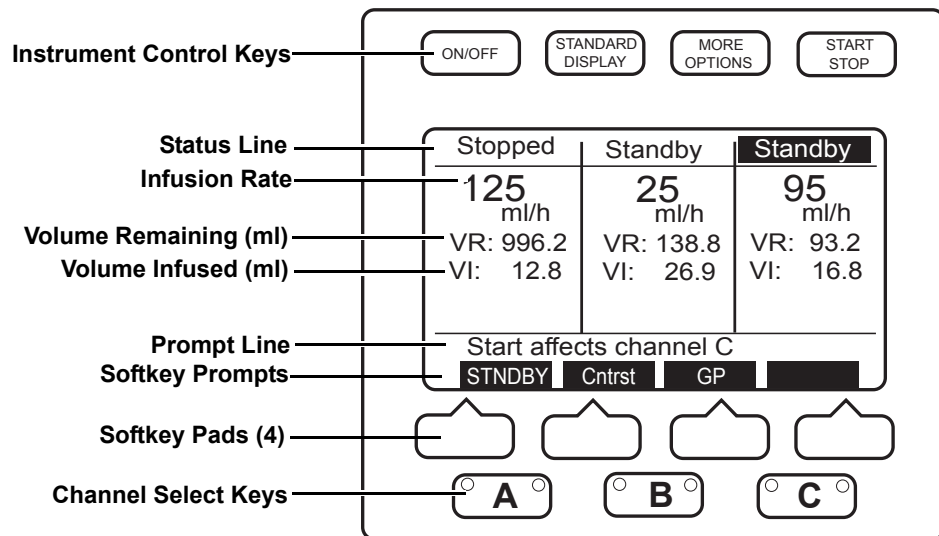

ON/OFF —turns the pump on and off.

STANDARD DISPLAY —allows you to display the Standard Display page to view infusion settings for all channels.

MORE OPTIONS —allows you to display additional softkey functions.

START STOP —starts or stops infusion on selected channels.

Status Line—displays the infusion status for each channel, either Infusion, Stopped, Standby, KVO, ALARM, FAULT, or SERVICE. When the status line is selected, the channel appears highlighted.

Prompt Line—displays messages that prompt you to make programming choices and/or take appropriate actions.

Softkey Prompts—displays function of specific softkey.

- **STDNBY**—appears in the softkey information line when START/STOP is pressed during infusion.
- **Cntrst**—(Contrast) Brightens or dims the display.
- **GP**—Indicates the full name of the selected Device Type on the prompt line when selected.

NOTE

Additional softkey prompts are displayed by pressing the MORE OPTIONS key.

Programming Page

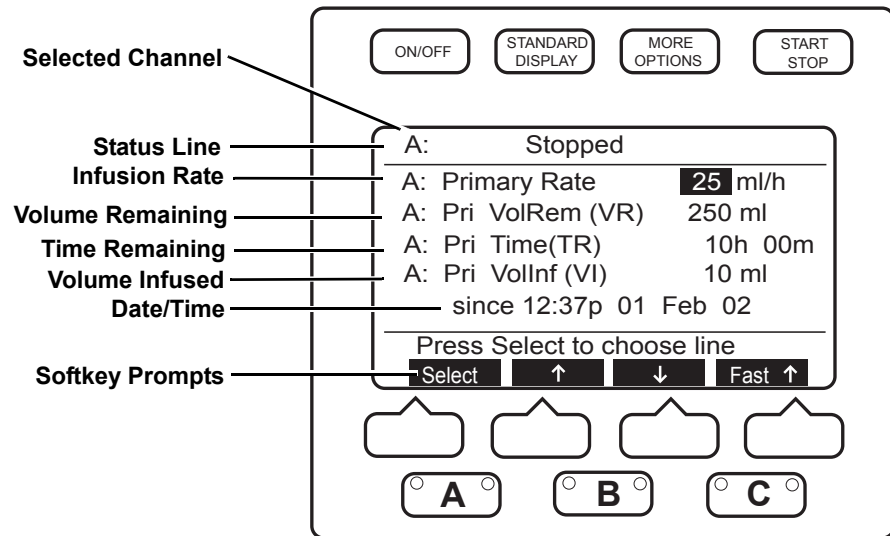

Selected Channel—indicated by the letter displayed at the beginning of the first five lines.

Status Line—displays the infusion status for the selected channel.

Date/Time—displays the time and date when volume infused was last cleared and infusion began.

Softkey Prompts

- **Select**—moves the highlight bar through programmable infusion parameters.
- **↑**—increases highlighted value.
- **↓**—decreases highlighted value.
- **Fast↑**—increases highlighted value at greater increments.
- **Fast↓**—decreases highlighted value at greater increments.

The Programming Page

The programming page is used to view infusion settings for all active channels, activate additional standard display softkey prompts, select channel and display the Programming Page, program an infusion, access alarm information, and to activate additional Programming Page softkeys.

Turn the Pump On and Off

To turn the pump on

1. From the front panel, press **ON/OFF**.

The MedSystem III performs an automatic self test on start up.

2. Listen for a beep to ensure that the audio alarm transducer functions properly. The information page appears momentarily.

3. Hold down **ON/OFF** to continue displaying the information page.

When the ON/OFF key is released, the Standard Display page appears.

To turn the pump off

Press and hold **ON/OFF**.

The display disappears and the pump is turned off.

View Infusion Settings for All Active Channels

To view infusion settings for all active channels

Press **STANDARD DISPLAY**.

The Standard Display page appears.

Activate Additional Standard Display Softkey Prompts

To activate additional Standard Display softkey prompts

With the Standard Display page displayed, press **MORE OPTIONS** once.

The TotVol Device, Config, and Note softkeys appear.

Select Channel and Display

To select Channel and Display Programming pages

1. Press **MORE OPTIONS** again.
The Batlog and DemoWD softkeys appear.
2. Press a Channel Select key, either **A**, **B** or **C**.
The programming page for the selected channel appears.

Program an Infusion

To program infusion

1. From the programming page, press **Select** to select the value to change.
The selected value is highlighted.
2. Scroll through the values using either **↑**, **↓**, **Fast↑**, or **Fast↓**.
 - **↑** and **Fast↑** increases the highlighted values in single or multiple increments.
 - **↓** and **Fast↓** decreases the highlighted values in single or multiple increments.
 - Press **↑** or **↓** to change direction of the **Fast↑** or **Fast↓**.
The highlighted value remains flashing until you press **Enter**. If you do not press **Enter**, an entry incomplete advisory alarm is sounded.
3. Press **Enter** to accept the new value.
If the channel status is Stopped or Standby, the next programmable value is highlighted. If the status is infusing, the selected value remains highlighted.
4. Press **MORE OPTIONS** to recall a previous value after a new value is introduced but not entered.
The Recall Softkey appears.
5. Press **Recall**.
The number returns to the previous value.
6. Press **START STOP**.
The infusion starts or stops immediately, unless the channel's programming is incomplete, or if an advisory, alarm, or fault condition exists on the selected channel. ALARM is displayed in the affected channel status line. An alarm condition is displayed on the Standard Display of the affected channel.

Access Alarm Information

To access alarm information

Press the affected Channel Select key, either **A**, **B** or **C**.

The alarm information page appears for the affected channel. See the Alarms, Advisories and Prompts section of this manual for more alarm information on the use of the Dose Rate Calculator function.

Activate Additional Softkeys

To activate additional programming page softkeys

1. From the Programming page, press **MORE OPTIONS**.
2. Press **2° Sec** to access the Secondary page.
- or -
Press **CalcON** to access the Dose Rate calculation page.
3. Press **MORE OPTIONS**.
4. Press **CalcOff** to discontinue the use of the Dose Rate calculator.
See the Getting Started section of this manual for information on the use of the Dose Rate Calculator function.

Program Primary Functions

To set Primary Rate

1. Press **A**, **B** or **C**.

The Programming page appears and the Primary Rate is highlighted.

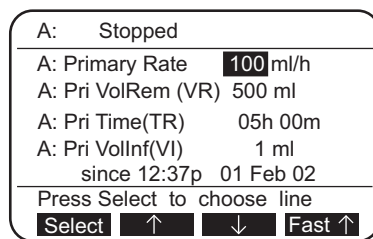

2. Press **Select** if the current rate is desired.
- or -
Press **↑**, **↓**, **Fast ↑** or **Fast ↓** to change the rate.
The Primary Rate value flashes.
3. Press **Enter** to confirm.
Once the Primary Rate is confirmed, the Volume Remaining (VR) value appears highlighted.

To set Primary Volume Remaining

1. Press **Select** if the current VR is desired.

- or -

Press **↑**, **↓**, **Fast ↑** or **Fast ↓** to change VR.

The Primary Volume Remaining value flashes.

| | |
|-----------------------------|---------------------------------|
| A: Stopped | |
| A: Primary Rate | 100 ml/h |
| A: Pri VolRem (VR) | 500 ml |
| A: Pri Time(TR) | 05h 00m |
| A: Pri VolInf(VI) | 1 ml |
| since 12:37p 01 Feb 02 | |
| Press Select to choose line | |
| Select | ↑ ↓ Fast ↑ |

2. Press **Enter** to confirm.

The primary time remaining (TR) is calculated automatically based on VR and rate. Once the Volume Remaining is confirmed, the Volume Infused (VI) value appears highlighted.

To clear Primary Volume Infused (VI)

1. Press **Select** if the current VI is desired

| | |
|-----------------------------|---------------|
| A: Stopped | |
| A: Primary Rate | 100 ml/h |
| A: Pri VolRem (VR) | 500 ml |
| A: Pri Time(TR) | 05h 00m |
| A: Pri VolInf(VI) | 800 ml |
| since 12:37p 01 Feb 02 | |
| Press Select to choose line | |
| Select | Clear |

- or -

Press **Clear** to reset volume infused to zero.

The date and time are cleared. The Clear softkey toggles to Recall.

2. Press **Enter** to confirm

- or -

Press **Recall** to recall previous VI, date and time.

| | |
|-----------------------|---------------|
| A: Stopped | |
| A: Primary Rate | 100 ml/h |
| A: Pri VolRem (VR) | 500 ml |
| A: Pri Time(TR) | 05h 00m |
| A: Pri VolInf(VI) | 0 ml |
| since ---- | |
| Press Enter or Recall | |
| Enter | Recall |



3. Open the regulating clamp on administration set.

4. Press **START STOP** to begin infusion.

The channel starts infusing. The current date and time are displayed. The green infusion light on channel key remains illuminated.

5. Press .
Display reverts to Standard Display page after one minute.
6. Verify the VI settings.
7. Verify the solution flow from the primary container.



To titrate or change Primary Rate during infusion

1. Press ,  or .

The Programming page appears and the Primary Rate is highlighted.

2. Press ↑, ↓, Fast ↑ or Fast ↓ to change the rate.
The Primary Rate value flashes.
3. Press **Enter** to confirm.
The new rate begins infusing immediately.



To change Volume Remaining during infusion

1. Press ,  or .

The Programming page appears and the Primary Rate is highlighted.

2. Press **Select** to highlight VR.
3. Press ↑, ↓, Fast ↑ or Fast ↓ to change the VR.
The Volume Remaining value flashes.
4. Press **Enter** to confirm.
The infusion continues with the new volume remaining.

To clear Volume Infused during infusion

1. Press ,  or .

The Programming Page appears and the Primary Rate is highlighted.

2. Press **Select** to highlight VI.
3. Press **Clear** then Enter to reset volume infused to zero.
The Date and time are cleared. The Clear softkey toggles to Recall.

NOTE

When the channel VI is cleared, that volume is not subtracted from the volume on the TotVol page

4. Press **Enter** to confirm.
The infusion continues with the volume infused reset to zero. The current date and time are displayed.
5. Press **Recall** to recall the previous VI value, date and time.

Making Changes While Infusing

To simultaneously clear Total Volume Infused for all channels

1. Press **STANDARD DISPLAY**.

The standard display page appears.

2. Press **MORE OPTIONS**.

The TotVol, Device, Config and Note softkeys appear.

3. Press **TotVol**.

The Total Volume page appears. The VI for each channel and total pump VI values are highlighted.

| | | |
|-----------------------------|---------|------------------|
| Stopped | Stopped | Stopped |
| TotVI A | TotVI B | TotVI C |
| Pri 20 | Pri 20 | Pri 20 |
| Sec 0 | Sec 0 | Sec 0 |
| = 20 | = 20 | = 20 |
| Total VI = | | 60 ml |
| since | | 03:25p 10 Feb 02 |
| Press ClrTot to clear TotVI | | |
| | | ClrTot |

4. Press **ClrTot** to reset volume infused to zero.

The date and time are cleared in the display.

| | | |
|-----------------------|---------|---------------|
| Stopped | Stopped | Stopped |
| TotVI A | TotVI B | TotVI C |
| Pri 0 | Pri 0 | Pri 0 |
| Sec 0 | Sec 0 | Sec 0 |
| = 0 | = 0 | = 0 |
| Total VI = | | 0 ml |
| since | | ---- |
| Press Enter or Recall | | |
| Enter | | Recall |

5. Press **Enter** to accept clearing of all values

- or -

Press **Recall** to recall the previous total VI, date and time.

To place a channel on standby during infusion

CAUTION

The infusing channel should always be stopped prior to removing a cassette.

NOTE

When a channel is Stopped for two minutes with a cassette in place, a Channel Not In Use advisory alert sounds. When a channel is on Standby, the advisory does not sound.

1. Press appropriate channel **A**, **B** or **C**.

2. Press **START STOP** to stop the infusion.

3. Press **STANDARD DISPLAY**.

The Standard Display page appears.

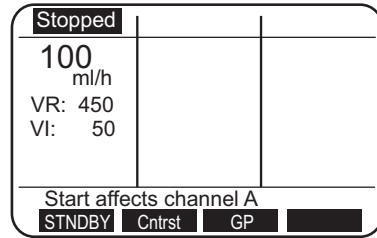

4. Press **STNDBY**.

To start an infusion from standby status

1. Press appropriate channel **A**, **B** or **C**.
2. Press **START STOP** to start the infusion.

Programming Options

To setup an infusion by Rate/Volume or Volume/Time

1. Press **START STOP** if the channel is infusing.
2. Press **STANDARD DISPLAY** if the Standard Display page not already displayed.
3. Press **MORE OPTIONS**.

The TotVol, Device, Config and Note softkeys appear.

4. Press **Config**.

The first of five Instrument Settings pages appears.

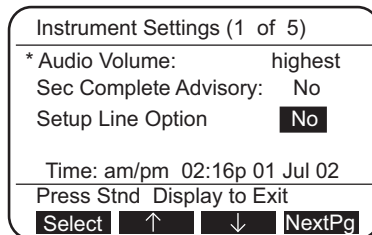

5. Press **Select** to select the Setup Line Option.
6. Press **↑** or **↓** to select **Yes**.
The **↑** and **↓** symbols are not displayed if the pump is infusing.
7. Press **Enter** to enable programming option.
8. Press channel **A**, **B** or **C**.

9. Press **Select** to select Setup:
Select VR and Time
- or -
Setup: Select VR and Rate

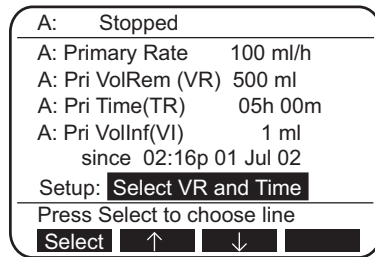

NOTE

If the selection highlighted is not desired, press ↑ or ↓ to change setup selection.

The current selection flashes.

10. Press **Enter** to accept.

The selection indicator moves to top of page.

11. Enter the desired settings.

NOTE

The Rate appears highlighted but cannot be changed if Volume/Time option is active. Time remaining selection appears highlighted but cannot be changed if Rate/Volume option is active.

KVO Status

When a channel is infusing at KVO rate:

- The green light on channel key remains on.
- The red light on channel key flashes.
- A two toned advisory alert sounds.

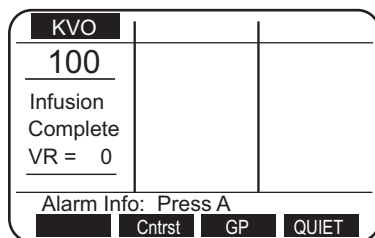

To resume infusion when VR=0 (KVO)

1. Press appropriate channel A B or C twice.

The VR selection appears highlighted.

| | | |
|-----------------------------|------------------------|-------------|
| A: | KVO | 3.0 ml/h |
| A: Primary Rate | | 100 ml/h |
| A: Pri VolRem (VR) | | 0 ml |
| A: Pri Time (TR) | | ---- |
| A: Pri VolInf (VI) | | 100 ml |
| | since 12:37p 01 Feb 02 | |
| Press Select to choose line | | |
| Select | ↑ | ↓ REPEAT |

2. Press **REPEAT** to recall previous VR
- or -
Press ↑, ↓, Fast ↑ or Fast ↓ to change VR.
The selected value flashes.
3. Press **Enter** to confirm.
4. Press to resume infusion and stop KVO rate.

NOTE

If the current infusion rate is set below KVO rate, the channel infuses at the lower rate.

Secondary Mode

The Secondary Mode option allows two different rates of infusion to be administered sequentially. When the Secondary volume remaining reaches zero, the primary infusion resumes automatically.

To avoid the possibility of concurrent flow during Secondary delivery of intermittent medications, setup the administration set as recommended below.

WARNING

Do not set the Secondary rate over 275 ml/h. Doing so might result in a concurrent flow with the primary container.

To prepare the Administration Set and Container

1. For Needle-Free sets, attach the Secondary to the upper primary Y site, below a check valve.
2. Prepare the Secondary IV container according to your institution's policy.
3. Suspend Secondary solution container at least 8 inches (20 cm) above primary solution container.

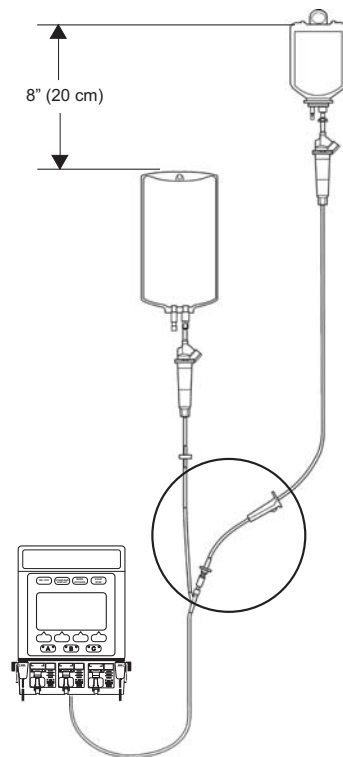

4. Press A B or C to select channel.

To program a Secondary infusion

1. Press **A**, **B** or **C**.

The Primary Programming page appears.

2. Press **MORE OPTIONS**.

The following screen appears.

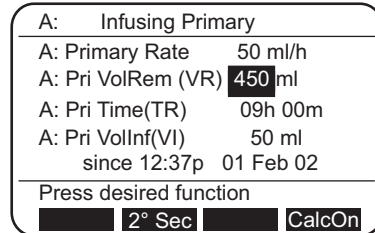

3. Press **2° Sec**.

The Secondary Programming page appears in reverse highlight.

To set Secondary Volume Remaining (VR)

1. Press **Select** to highlight Secondary VR, if necessary.

2. Press **REPEAT** to enter the last VR selected,
- or -

Press **↑**, **↓**, **Fast ↑** or **Fast ↓** to change VR.

The selected value flashes.

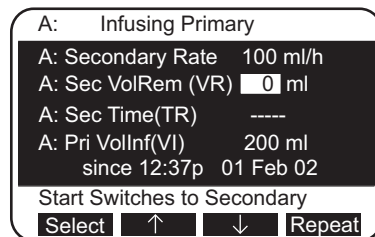

3. Press **Enter** to confirm.

The Secondary time remaining (TR) is calculated automatically, based on VR and Rate. Once the Secondary Volume Remaining is confirmed, the Secondary Volume Infused (VI) value appears highlighted.

To clear Secondary Volume Infused (VI)

1. Press **Select** if current VI is desired,

- or -

Press **Clear** to reset volume infused to zero.

The date and time are cleared. The Clear softkey toggles to Recall.

2. **Enter** to confirm,

- or -

Press **Recall** to recall the previous VI value, date and time.

To set the Secondary Rate

1. Press **Enter** to confirm.
2. Press **Select** if the current rate is desired,
- or -
Press **↑**, **↓**, **Fast ↑** or **Fast ↓** to change Rate.
The selected value flashes.

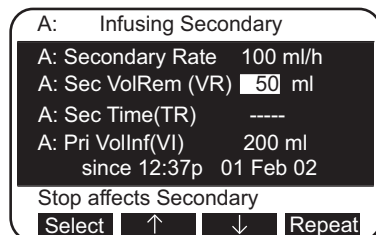

3. Press **Enter** to confirm.
4. Open the regulating clamp on the Secondary administration set.
5. Press **START STOP** to begin infusion.

Four audible tones sound if a primary infusion is in progress. The MedSystem III starts infusing at the Secondary rate. The current date and time are displayed.

NOTE

The display reverts to the Standard Display page after one minute unless you press ON/OFF.

6. Verify the settings.
7. Verify the solution flow from the Secondary container.

To set the rate of infusion from a time entry

The infusion rate can be set with the volume remaining (VR) and time entry.

1. Press **MORE OPTIONS** from the Standard Display.
2. Press **Config** at the bottom of the display.
3. Select **Change Instrument Settings** from the menu.
4. Press **↑** or **↓**, to change the **Setup Line Option** from **NO** to **YES**.
5. Return to the Standard Display and select a channel.
The display reads Setup: Select VR and Rate.
6. Select **Set: Select VR and Rate**.
7. Press **Accept** to set a time.

To titrate or change Secondary Rate during infusion

NOTE

The channel display on the Standard Display appear in reversed highlight.

1. Press **A**, **B** or **C**.

The Primary Programming page appears. The Secondary Rate is highlighted.

2. Press **↑**, **↓**, **Fast ↑** or **Fast ↓** to change the rate.

The selected value flashes.

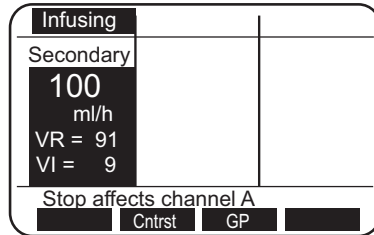

3. Press **Enter** to confirm.

The new rate begins infusing immediately.

To review or change the primary value(s) during Secondary Infusion

1. Press **A**, **B** or **C**.

The Secondary Programming page is displayed.

2. Press **MORE OPTIONS**.

The 1° Pri and CalcOn softkeys appear.

3. Press **1° Pri**.

The Primary Programming page appears.

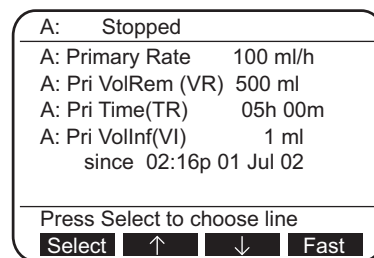

4. Press **Select** to highlight value(s) to change.
5. Press **↑**, **↓**, **Fast ↑** or **Fast ↓** to change value(s).
6. Press **Enter** to confirm.

To start the primary infusion before Secondary completes

WARNING

Pressing **START STOP** results in the remaining secondary medication being delivered at the primary rate if the regulating clamp on the secondary set was not closed.

1. Close the regulating clamp on the secondary infusion set.
2. Press **A**, **B** or **C**.
The Secondary Programming page appears.
3. Press **MORE OPTIONS**.
The 1° Pri and CalcOn softkeys appear.
4. Press 1° Pri.
The Primary Programming page is displayed.
5. Press **START STOP** to begin the primary infusion and stop the Secondary infusion.
The system sounds four audible tones and the infusion starts at the primary rate.

Dose Rate Calculator programming using a specific drug name

WARNING

Ensure the correct entry of all drug calculation infusion parameters. Consult the drug manufacturer's labeling for information concerning the appropriate administration guidelines and dosages.

NOTE

The Dose Rate Programming page does not display if a channel is infusing. If infusing in the Secondary mode, switch to the primary mode and stop infusion before proceeding.

If you press **A**, **B** or **C** at any time during Dose Rate Calculator set-up, the system returns the highlight to the selection at the top of the page.

The Dose Rate Calculator programming using a specific drug name calculates a volumetric or dose rate based on values entered for patient weight, drug concentration (drug amount and diluent volume) and dosing parameters. If a dose is entered, the volumetric rate is calculated. If a volumetric rate is entered, the dose is calculated.

1. Press **A**, **B** or **C**.

The Primary Programming page appears.

| | |
|-----------------------------|--------------------|
| A: Stopped | |
| DRUG? | Wt ---- KG= 0.0 LB |
| A:Conc | ----- mg/---- ml |
| A:Dose | ----- mcg/kg/min |
| A:Rate | ----- ml/h |
| A:VR | 1 ml (Vol Rem) |
| A:VI | 0 ml DI 0.0 mg |
| Press Select to choose line | |
| Select | ↑ ↓ Clear |

2. If infusing, press **START STOP** to stop infusion.

3. Press **MORE OPTIONS**.

The 2° Sec and CalcOn softkeys appear.

4. Press **CalcOn**.

The Dose Rate Calculator Programming page appears. The DRUG? value is highlighted.

To program a drug

NOTE

When you change a drug name, the previous values are cleared and the drug concentration and dose rate parameters are changed to parameters appropriate for the selected drug.

1. Use the arrow softkeys to scroll through the alphabetized, abbreviated drug list.
 - ↓ moves A to Z.
 - ↑ moves Z to A.
 - Fast ↑ and Fast ↓ moves alphabetically through the drug name list. By default, Fast goes to the next letter of the alphabet.

| | |
|-----------------------------|--------------------|
| A: Stopped | |
| DOPAMINE | Wt 70.0 KG=154.3LB |
| A:Conc | 400 mg/ 250 ml |
| A:Dose | 5.0 mcg/kg/min |
| A:Rate | 13.1 ml/h |
| A:VR | 250 ml (Vol Rem) |
| A:VI | 0 ml DI 0.0 mg |
| Press Select to choose line | |
| Select | ↑ ↓ Clear |

2. Press Enter when desired drug name is highlighted.

The weight (Wt.) value is highlighted.

To program weight

1. Enter the patient's weight in kilograms using the ↑, ↓, Fast ↑ and Fast ↓ softkeys.

2. Press **Enter** when desired weight is displayed.
The concentration (Conc.) selection is highlighted.

To program concentration

1. From the Dose Rate Calculator Programming page, select the concentration using the ↑, ↓, Fast ↑ and Fast ↓ softkeys.
2. Press **Enter** when the desired concentration is displayed.
The value for the diluent volume is highlighted.
3. Select the diluent volume using the arrow softkeys.
4. Press **Enter** when the desired volume is displayed.
The VR is automatically set when the diluent volume value is entered. It can be changed if desired. The Dose selection is highlighted.

NOTE

The calculated rates for infusion are fractional and are displayed as a fraction on the Standard Display, even if the Device Type is set for whole numbers.

To program dose

NOTE

In Neonatal Device type, the concentration will always start at a numeric value of 0.1.

1. Select the dose using the ↑, ↓, Fast ↑ or Fast ↓ softkeys.
2. Press **Enter** when desired dose is displayed.
The volumetric rate is automatically calculated. The Rate selection appears highlighted.

To change the Volumetric Rate

1. Select the rate value using the ↑, ↓, Fast ↑ or Fast ↓ softkeys, if the dose rate is not as desired.
2. Press **Enter** when desired volumetric rate is displayed.

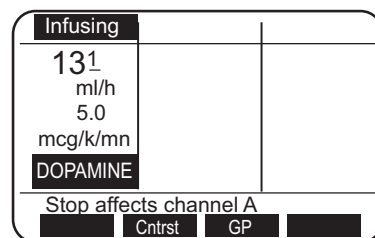



When rate is changed, dose value is automatically calculated. The VR selection appears in highlight.

To change the Volume Remaining

1. Change the VR value using the ↑, ↓, Fast ↑ or Fast ↓ softkeys.

2. Press **Enter** when the desired VR is displayed.
The VI selection appears in highlight.

To clear the Volume Infused (VI) and Dose Infused (DI)

1. Press **Clear** and then **Enter** to reset volume infused to zero.
The DI selection appears in highlight.
2. Press **Clear** then **Enter** to reset dose infused to zero.
3. Open the regulating clamp.
4. Press  to begin infusion.
The channel starts infusing.
5. Press .

NOTE





The display reverts to the Standard Display page after one minute and the Dose Rate Calculator parameters are displayed.

6. Verify the settings.
7. Verify the solution flow from solution container.

NOTE

You must stop the infusion to make changes to the drug name, weight, or concentration.

To change Dose Rate Calculator values while infusing

1. Press ,  or .
- The Dose Rate Calculator Programming page appears. The dose value appears in highlight.
2. Press **Select** to scroll through values that can be changed.
 3. When the value to be changed is highlighted (Dose, Rate, VR, VI, DI), use the **↑**, **↓**, **Fast ↑** or **Fast ↓** softkeys until the desired value is displayed.
When the dose is changed, the rate is automatically recalculated. When the rate is changed, the dose is automatically recalculated. When the value for VI or DI is highlighted, the **Clear** softkey becomes active. Pressing the **Clear** softkey changes the value to 0.0.
 4. Press **Enter** after each value change to accept the new value.
The new rate begins infusing immediately.
 5. Press .

NOTE

The display reverts to Standard Display page after one minute.

6. Verify the settings.

- Verify the solution flow from the solution container.

Dose Rate Calculator Programming with DRUG?

To program the Dose Rate Calculator with DRUG?

NOTE

The Dose Rate Programming Page does not display if a channel is infusing. If infusing in the Secondary mode, switch to the primary mode and stop infusion before proceeding.

The DRUG? selection can be used to calculate a drug not listed in the pump or for an alternative dosing regimen.

- Press **A**, **B** or **C**.

The Primary Programming Page is displayed.

- Press **START STOP** if a channel is infusing.

- Press **MORE OPTIONS**.

The 2° Sec and CalcOn softkeys appear.

- Press **CalcOn**.

The Dose Rate Calculator Programming page appears. The Drug? value appears in highlight.

| | | | |
|-----------------------------|----------|----------|--------------|
| A: | Stopped | | |
| DRUG? | Wt | ---- | KG= 0.0 LB |
| A:Conc | ----- | | mg/---- ml |
| A:Dose | ----- | | mcg/kg/min |
| A:Rate | ----- | | ml/h |
| A:VR | 1 | | ml (Vol Rem) |
| A:VI | 0 ml | DI | 0.0 mg |
| Press Select to choose line | | | |
| Select | ↑ | ↓ | Clear |

- Press **Select**.

The Wt.value appears in highlight.

To program weight

- From the Dose Rate Calculator Programming page, select the patient's weight in kilogram using the **↑**, **↓**, **Fast ↑** and **Fast ↓** softkeys.
- Press **Enter** when desired weight is displayed.

The Conc. value appears in highlight.

To program concentration

NOTE

In Neonatal Device type, the concentration will always start at a numeric value of 0.1.

1. From the Dose Rate Calculator Programming page, select the concentration using the ↑, ↓, Fast ↑ and Fast ↓ softkeys.
2. Press **Enter** when the desired concentration is displayed.
The concentration parameters selection is highlighted.

Drug Concentration Parameters

Gm, mg, mcg, mMol, mEq, mUn, Un

3. Select the desired concentration parameters using the ↑, ↓, Fast↑ and Fast ↓ softkeys.
4. Press **Enter** when the desired parameter is displayed.
The value for diluent volume appears in highlight.
5. Select the diluent volume value using the ↑, ↓, Fast ↑ and Fast ↓ softkeys.
6. Press **Enter** when the desired volume is displayed.
The VR is automatically set when the diluent volume is entered. It can be changed if desired. The Dose parameters value appears highlighted.

To program dose

1. From the Dose Rate Calculator Programming page, select the dose parameters (measure/weight/time) using the ↑, ↓, Fast ↑ and Fast ↓ softkeys.

Dose Parameters

measure—Gm, mg, mcg, ng, mMol, mEq, mUn, Un

weight—kg

time—min, h, or day

2. Press **Enter** when each desired dose parameter is displayed.
The Dose value appears highlighted.
3. Select the dose using the ↑, ↓, Fast ↑ and Fast ↓ softkeys.
4. Press **Enter**.
The Rate parameters value appears highlighted.



To change the Volumetric Rate

1. From the Dose Rate Calculator Programming page, select volumetric rate using the arrow softkeys if dose calculation is not desired.
2. Press **Enter** when the desired rate is displayed.
The dose is automatically calculated when the rate is changed. The VR value appears in highlight.

To change the Volumetric Remaining

1. From the Dose Rate Calculator Programming page, select the VR using the arrow softkeys.
2. Press **Enter** when the desired VR is displayed.
The VI value appears highlighted.

To clear the Volume Infused (VI) or Dose Infused (DI)

1. Press **Clear** and then **Enter** to change VI value to 0.
The DI value appears highlighted.
2. Press **Clear** then **Enter** to change DI value to 0.
3. Open the regulating clamp.
4. Press  to begin infusion.
The channel starts infusing.
5. Press .

NOTE





The display reverts to the Standard Display page after one minute and the Dose Rate Calculator parameters are displayed.

6. Verify the settings.
7. Verify the flow.

To edit a drug List

Use the Drug List Editor to edit/customize a drug list. See the User Manual for Drug List Editor (DLE).

To discontinue the Dose Rate Calculator option

1. Press ,  or .
- The Dose Rate Calculator Programming page appears.
2. Press  to stop infusing.
3. Press .
4. Press **CalcOff**.
The Primary Programming page appears. The Volumetric Rate, volume remaining, and volume infused from Dose Rate Calculator are displayed.

Facts about Dose Rate Calculator

- Drug name, patient weight, or drug concentration cannot be changed while infusing. Changes to patient weight or concentration recalculates the volumetric rate but maintains the dose rate.
- Drug names may be abbreviated if the name contains more than eight letters.

- Weight can only be entered in Kg's but is displayed in Kg's and Lbs. Weight units can be switched to grams by pressing ↓ to value of 1Kg then press again ↓. A two tone advisory sounds.
- If dose measurement parameters and concentration measurement parameters are unrelated, a volumetric rate will not calculate. Attempts to start display a prompt message: Verify all dose settings.
- When a drug amount is 10,000 or greater, a K is used to replace 000th, such as 10,000=10K; 12,000=12K.
- If a recalculated dose results in a rate outside the rate ranges, a prompt message is displayed: Rate too High, re-enter value or Rate too Low, reenter the value.
- If a recalculated rate results in a dose outside the dose range, the channel infuses at the entered rate, but the dose displays the minimum or maximum allowable limit: such as <0.1 or >999k.
- The Secondary option cannot be used when the Dose Rate Calculator is enabled.
- If the MedSystem III is off for more than five minutes, the Dose Rate Calculator mode reverts to the primary mode.

Device

NOTE

The Device Type programming selection affects all three channels. It is not possible to independently program different Device Types for a channel.

There are six Device Types with preset parameters that accommodate specific clinical applications:

- General Purpose
- Neonatal
- Controller Pressure
- Operating Room
- General Purpose II
- Operating Room II

When setting up the pump, select the device type that best suits your clinical needs. The abbreviated name of the Device Type appears as a softkey on the

Standard Display page. Pressing the softkey displays the device type in non-abbreviated form on the prompt line.

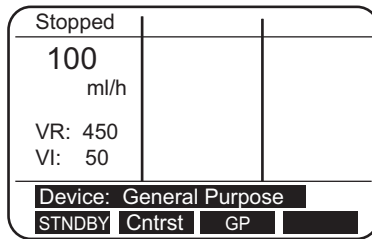

Maximum rate, maximum volume, pressure and air-in-line threshold are configured at the factory. See Table 1 for a complete listing of preset parameters. Refer to the Config softkey section for programmable and configurable parameters.

These parameters can be modified to meet your institution’s specific requirements using FMS software.

To change the device type

1. Press **STANDARD DISPLAY**.

2. Press **MORE OPTIONS**.

The TotVol, Device, Config and Note softkeys appear.

3. Press **Device**.

The currently selected Device Type appears with an asterisk and is highlighted.

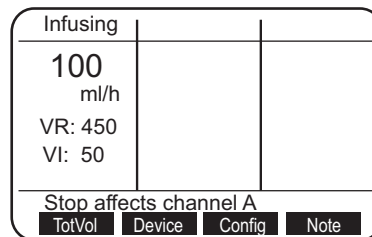

4. Press **Select** to move the highlight through the list.

- Press **Enter** when the desired device is highlighted.

If preset values are compatible with the newly selected device type, an asterisk appears next to the device type name.

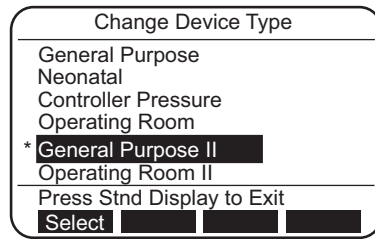

If channel is not infusing when device type is changed and preset values are not compatible with the newly selected device type, the display switches to a notification screen, the incompatible channel(s) is indicated. A choice is given to continue.

- Select **Yes**.

The incompatible values are cleared, the display reverts to Standard Display page and the new Device Type becomes active.

- or -

Select **No**.

The display reverts to Change Device Type page.

If channel is infusing when device type is changed and preset values are not compatible with the newly selected device type, the display switches to the notification screen and the incompatible channel(s) is indicated. A choice is given to continue.

- Select **No**.

The display reverts to Change Device Type page for user to select another device type.

- or -

Select **Yes**.

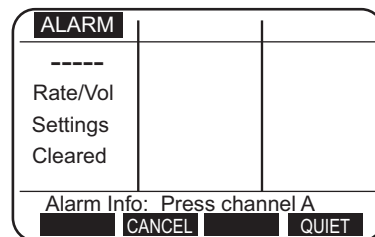

The pump will alarm, infusion will stop on affected channel(s), and the display reverts to Standard Display with Alarm indicated for affected channel.

- Press affected channel A B or C.

9. Follow instructions displayed.

NOTE



The values shown in table can be modified to meet your facility's requirements using FMS software. To review actual default parameters on a Instrument DLE. Select a Device Type and refer to Instrument Settings pages 2 through 5. An asterisk appears beside settings which are not a factory default.

| Default Parameter | General Purpose | Neonatal | Controller Pressure | Operating Room | General Purpose II | Operating Room II |
|--|-----------------|-----------------|----------------------|-----------------|--------------------|-------------------|
| Occlusion Detection Method | Baseline | Baseline | Absolute Threshold | Baseline | Baseline | Baseline |
| Occlusion Alarm Setting | Baseline +5 psi | Baseline +3 psi | 3ft H ₂ O | Baseline +5 psi | Baseline +5 psi | Baseline +5 psi |
| Maximum Pressure | 15 psi | 15 psi | 3ft H ₂ O | 15 psi | 15 psi | 15 psi |
| Air-in-Line Alarm Threshold | 500 µl | 50 µl | 500 µl | 500 µl | 500 µl | 500 µl |
| KVO Rate* | 3 ml/h | 1.0 ml/h | 3 ml/h | 3 ml/h | 3.0 ml/h | 3.0 ml/h |
| Rate Range | 1–999 | 0.1–99.9 ml/h | 1–299 ml/h | 1–999 ml/h | 0.1–999 ml/h | 0.1–999 ml/h |
| Maximum VR Setting | 9999 ml | 9999 ml | 9999 ml | 9999 ml | 9999 ml | 9999 ml |
| Pump Not in Use Advisory | Yes | Yes | Yes | No | Yes | No |
| All Setting for VR | N/A | N/A | N/A | Option | N/A | Option |
| *The channel infuses at the KVO rate shown in the table or at the current infusion rate, whichever is lower. | | | | | | |

Config (Configuration)

The Config option allows the user to view and/or change some Instrument settings. There are five pages in this option. Items shown on page 1 of the Config option can be changed by the user, see the table below. Pages 2–5 of the Config option can only be changed by qualified personnel using FMS software.

To access instrument setting information

1. Press .
2. Press .

The TotVol, Device, Config and Note softkeys appear.
3. Press **Config**.

The first of five Instrument Settings pages appears. An asterisk indicates options that have changed from factory settings.
4. Press **Select** to advance through the list.
5. Press \uparrow , \downarrow , to change a highlighted setting.
6. Select softkey changes to the Enter and NextPg softkey changes to Recall when a setting is changed.
7. Press **Enter** to accept new setting

- or -

 Press **Recall** to recall previous setting.
8. Press  to exit the Instrument Settings page.

| Option | Selection | Description |
|-----------------------|----------------------------------|--|
| Audio Volume | low medium high highest | An audible tone accompanies each level to aid in determining the volume selection. If an alarm is ignored, the volume ramps to the highest audio unless disabled by the FMS. The factory default is highest. |
| Sec Complete Advisory | Yes No | Pump sounds two tones and displays an advisory when the Secondary VR=0. The factory default is No. |
| Setup Line Option | No Yes | Enables an infusion to be setup as rate/volume or volume/time. Stop the infusion before modifying this line option. The factory default is No. |
| Time | 24 hr am/pm | Allows the pump to be set with a 12 or 24 hour clock. The factory default is am/pm |
| Hours/Minutes | 0000–2359 | Each item can be adjusted when highlighted. |
| Day | 1–31 | |
| Month | Jan–Dec | |
| Years | 00-99 | |

Note Softkey

The Note soft key accesses the Special Note Message page. When a Note is programmed, it appears when the pump is turned on.

To access NOTE(s)

1. Press  .
2. Press  .

The TotVol, Device, Config and Note softkeys appear.

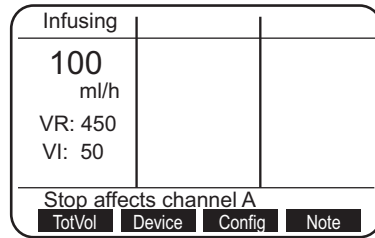

3. Press **NOTE**.

The note information is displayed. If no information has been programmed on the NOTE page, there is a two tone audible advisory and the message: There is no Special Note appears on the prompt line.

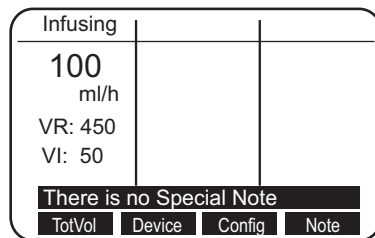

BatLog (Battery History Log)

The BatLog softkey accesses the Battery History Log page. This page is provided for the Biomedical Engineering staff to review and record battery history data.

To access the Battery History Log

1. Press  .

- Press **MORE OPTIONS** two times.

The BatLog and DemoWD softkeys appear.

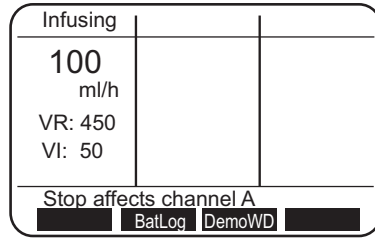

- Press **BatLog**.

The Battery History page is displayed.

- Press **ON/OFF** to exit Battery History page.

If you do not press ON/OFF the display reverts to the Standard Display page after 1 minute.

Chapter 3

Alarms, Advisories, and Prompts

Use this troubleshooting information in conjunction with the appropriate hospital procedures.

To respond to an advisory, alarm, or fault message

1. Press **QUIET**.
The audio tone stops and the red light flashes on the affected channel.
2. Press the affected channel **A**, **B** or **C**.
The Alarm Information page is displayed.
3. Take the appropriate action(s) indicated on the display.
4. Press **START STOP** to resume infusion.
The channel starts infusing.
5. Press **STANDARD DISPLAY**.

NOTE

The display reverts to the Standard Display page after one minute.

6. Verify the settings.

7. Verify the flow.

Alarm Response Keys

NOTE

The channel's VR and VI values are updated with each press of ClrAir softkey.

A  appears on Standard Display page to indicate that CONFIRM has been pressed.

QUIET

Silences Advisories, Alarms, and Faults for two minutes. Softkey is accessible during alarm status.

CANCEL

Clears alarm and advisory messages and stops tone. Use when alarm or advisory condition cannot be corrected or user chooses not to correct.

ClrAir

Moves air bubbles past air-in-line sensor. Each press of the ClrAir softkey displaces approximately 0.2 ml of air/fluid. Three beeps indicate when air bubble is no longer in front of the air-in-line sensor.

CONFIRM

Is present during Check Fluid Side alarms. Allows infusion to continue if no upstream occlusion is found.

RETRY



Resets resumable fault conditions. Used when attempting to reestablish normal operation of a channel.

SERVICE

Disables use of affected channel. Once pressed, servicing of instrument is required before channel can be used.



Advisories



Two beeps, slow flashing red light on infusing channel's channel key; infusion continues.



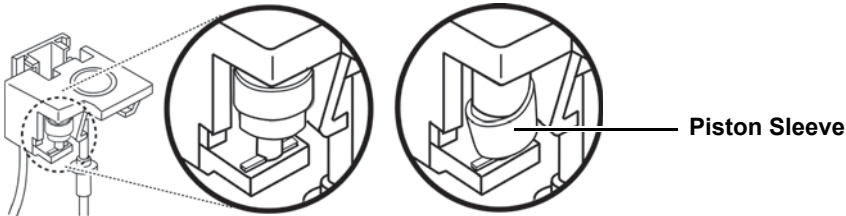

| Advisory | Meaning | Response |
|---------------------------|---|---|
| Check Air Sensor | At installation of cassette: a) air is detected in tubing; b) tubing collar is not properly seated; - or - c) air sensor is dirty or damaged. | Verify that the tubing collar is fully seated in air sensor recess. Verify tubing in air sensor recess is not damaged, twisted or dirty. Press ClrAir on channel's Alarm Information page. Three beeps indicate that an air bubble is no longer in front of the air sensor. If air is still present, remove the cassette and manually clear the air according to hospital policy. If no air is present, clean the air sensor recess as directed in the cleaning instructions. |
| Infusion Complete VR=0 | VR has counted down to zero. Channel is infusing at KVO rate. | Enter new VR or, if same volume is desired, press REPEAT. Press Enter. Press  to resume the primary infusion rate. Verify the fluid flow. |
| Low Battery | A minimum of 30 minutes of battery power remaining. | Connect AC adapter power cord to instrument. Plug into wall outlet. |
| Channel Not in Use | Two minutes have elapsed since cassette was installed or infusion was stopped. | Press STNDBY to place channel on Standby, or Press  to start infusion, or Remove the cassette. |

Alarms

The alarm sounds with four rapid beeps, the infusion stops, and the channel key flashes red.

| Alarms | Meaning | Response |
|---------------------|---|---|
| Air In Line | Air detected in fluid pathway during infusion, or the air sensor is dirty. | <p>Verify that the tubing collar is fully seated in air sensor recess.</p> <p>Verify that the tubing in air sensor recess is not damaged, twisted or dirty.</p> <p>Press ClrAir softkey on channel's Alarm Information page. Three beeps indicate that an air bubble is no longer in front of air sensor.</p> <p>NOTE: Each press of the ClrAir softkey displaces approximately 0.2 ml of air/fluid and updates channel's VR and VI values.</p> <p>If air is still present, remove cassette and manually clear air according to hospital policy.</p> <p>If no significant air is present, clean air sensor recess as directed in the cleaning instructions.</p> <p>Setup the pump at or slightly below IV site to minimize formation of micro bubbles.</p> <p>Press  to resume infusion.</p> |
| Air In Lower Tubing | <p>Air bubbles detected in fluid pathway with a total volume exceeding the air- in-line threshold setting.</p> <p>Possible outgassing and/or leaks in the administration set.</p> | <p>Check the administration set for leaks.</p> <p>Check the lower tubing for multiple small air bubbles.</p> <p>Press ClrAir softkey on the channel's Alarm Information page. Three beeps indicate that an air bubble is no longer in front of air sensor.</p> <p>NOTE: Each press of the ClrAir softkey displaces approximately 0.2 ml of air/fluid and updates channel's VR and VI values.</p> <p>If air is present, clear air according to the hospital policy.</p> <p>Setup the pump at or slightly below the IV site to minimize the formation of micro bubbles.</p> <p>If no significant air is present, press  to resume the infusion</p> |

| Alarms | Meaning | Response |
|---|--|---|
| Battery Depleted | Insufficient battery power. A minimum of 5 minutes of battery power remaining. | <p>Connect AC adapter power cord to instrument and plug into wall outlet.</p> <p>Press  to resume infusion(s).</p> <p>NOTE: If the lithium battery is depleted, the Drug List is lost and can only be reloaded into the pump using the Field Maintenance Software.</p> |
| Cassette Jammed | The cassette piston is difficult to move or the piston sleeve is loose. | <p>Remove the cassette, check placement of soft, plastic piston sleeve and reposition, if necessary.</p> <p>If condition continues, try cassette in a different channel.</p> <p>Replace administration set if alarm recurs or if piston does not move freely.</p> <p>If alarm recurs with several cassettes, channel may need service.</p> |
|  <p style="text-align: center;">Correct Incorrect</p> | | |
| Cassette Not Latched | Cassette is partially disengaged or latching mechanism is dirty. | <p>Push the cassette completely in. Ensure that the slide clamp is flush with the entire cassette.</p> <p>Press  to resume infusion.</p> <p>If the condition continues, try the cassette in a different channel. Replace the administration set if an alarm recurs.</p> <p>Clean the lower assembly according to the cleaning instruction described in the Maintenance section of this document.</p> |

| Alarms | Meaning | Response |
|---------------------|---|---|
| Cassette Removed | The cassette is removed from holder while channel is infusing. | Reinstall the cassette, and press  to resume infusion - or - Press Cancel. |
| Check Fluid Side | Possible upstream restrictions to flow. | Check the tubing between the container and the pump for a closed regulating clamp, a closed vent (with unvented container), a kinked tubing, empty syringe, or any restriction to flow. If NO occlusion is present, press CONFIRM. Press  to resume infusion. Verify fluid is flowing in drip chamber. A  appears on standard display to indicate Confirm has been pressed. |
| Faulty Cassette | The cassette may be damaged or inoperable. A possible malfunction of cassette sensor located in holder. | Reinsert the cassette in another channel. If the alarm recurs in the second channel, replace the administration set. If the alarm recurs with two cassettes in the same channel, discontinue use and contact qualified service personnel. |
| Fluid-Side Occluded | Upstream restriction to flow. | Check the tubing between the container and the pump for a closed regulating clamp, a closed vent (with unvented container), kinked tubing, empty syringe, or any restriction to flow. Clear the occlusion. Press  to resume infusion. Verify that the fluid is flowing in the drip chamber. |

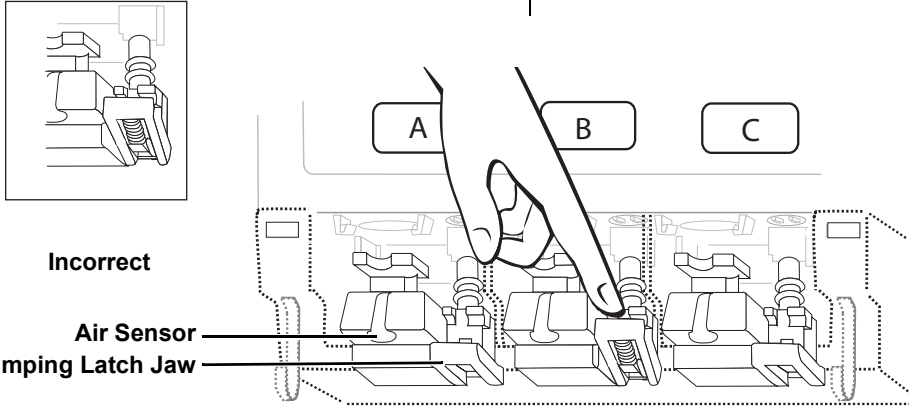
| Alarms | Meaning | Response |
|--|--|---|
| Patient-Side Occluded | Downstream restriction to flow. | <p>Check the tubing between the pump and the patient for kinks, closed clamps, closed stopcocks, clogged filters, site problems, and so on.</p> <p>Clear the occlusion or change the infusion site.</p> <p>Press START STOP to resume infusion.</p> <p>Verify that the fluid is flowing in drip chamber.</p> |
| Pumping Latch Closed | Pumping latch jaw located to right of air sensor is closed or broken. | <p>Using only your finger, push down on the pumping latch jaw until it snaps open.</p> <p>If the pumping latch jaw is visibly broken, contact the qualified service personnel.</p> |
| <div style="display: flex; align-items: center;">  </div> | | |
| Rate/Vol Settings Cleared | Rates and/or volumes are incompatible with the newly selected Device Type. | <p>Re-enter settings as required.</p> <p>Press START STOP to resume infusion.</p> |

Fault

When the system experiences a fault, a numeric message appears, an audible siren sounds, a rapid-flashing red light appears, and the infusion stops.



| Fault | Meaning | Response |
|----------------------|---|--|
| Channel Out of Order | Safety checks built into the software have detected a faulty channel. | CORRECTIVE ACTION for resumable faults only. Press the affected channel <input type="button" value="A"/> , <input type="button" value="B"/> or <input type="button" value="C"/> . |
| Fault Number | Safety checks built into software have detected a fault condition. | Follow the instructions on channel's Alarm Information page. Press RETRY to clear fault. If the fault recurs, press SERVICE and contact qualified service personnel. |

Watchdog

When the Watchdog feature is active, the display present a blank screen, a continuous audible tone sounds, the red and green lights flash continuously, and the infusion stops.

| Watchdog | Meaning | Response |
|--------------|---|--|
| Blank Screen | Safety checks built into the software have detected a faulty channel. | Attempt to reset Instrument: Turn instrument off, then on again. Press <input type="button" value="START STOP"/> to resume each channel that had been infusing. If the Watchdog alarm recurs or the MedSystem III cannot be turned on, replace the pump and notify qualified service personnel. |

Other Conditions

| Meaning | Response |
|---|--|
| Screen is too light or dark to read with instrument on. | Press  . Press the Cntrst softkey to change the screen contrast. |
| Instrument Shut Off: Low Power. | Connect the AC adapter cord to the MedSystem III and plug it into the wall outlet. |
| Instrument shut down after a Battery Depleted alarm had not been corrected. | The  next to external power receptacle is lit in green when the AC power is properly applied. |

- Notes -

Chapter 4

Maintenance

Specifications

| | |
|-------------------------------|--|
| Standards | UL 544, CSA C22.2, No. 125 |
| Case Material | Impact resistant poly carbonate/ABS alloy |
| Dimensions | Height: 7.875 inches (20.00 centimeters) Width: 6 inches (15.24 centimeters) Depth: 2.10 inches (5.33 centimeters) |
| Weight | Approximately 5.1 pounds (2.3 kilograms) including pole clamp |
| Air-in-Line (Default) | 500 µl (except for Neonatal device type which is 50µl) |
| Occlusion Pressure (Default) | 15 psi except for Controller Pressure device type which is 3 ft. H ₂ O |
| Operating Temperature | 50-104° Fahrenheit (10° - 40° Celsius) |
| Transport/Storage Temperature | -4 to +131° Fahrenheit (-20 to + 55°C) (<95°F or 35°C for optimum battery life) |
| Rate Range | 0.1 - 999 milliliter per hour (each channel) |
| Volume Range | 0.1 - 9999 milliliter (each channel) |
| KVO Rate Range | 0.1 - 20.0 milliliter per hour |

| | |
|---|---|
| Rate Accuracy: | 1.0 - 999 ml/hr. $\pm 5\%$ with a standard deviation of 1.96 under specified conditions.* 0.1 - 0.9 ml/hr. $\pm 10\%$ with a standard deviation of 1.96. |
| Administration Sets | Use only MedSystem III Administration Sets. |
| Power Consumption | 6 watts AC power. Use only Instrument AC Adapter, Model 1555, 1565, 1560A ordered as part number 2861089. |
| Batteries | Main – Rechargeable NiCd Battery Pack Memory Back-up – Non rechargeable Lithium NOTE: Use only approved CareFusion Battery packs. |
| Battery Charge | A fully charged battery has a minimum of 6 hours running time with all channels running at 125 milliliters per hour and backlight usage of 2 minutes per hour. The main battery retains 80% of its capacity after 500 charging cycles, and retains 90% of its capacity after 3 months of continuous AC charging. NOTE: Replacement of both the main and memory backup batteries must be performed by qualified service technicians. |
| AC Adapter & Cord Length | Model 1555, 7.5 Vdc @ 1 Amp with 10 ft. cord. Model 1560A, 7.5 Vdc @ 1.65 Amp with 10.5 ft. cord. Model 1565C 7.5Vdc @ 1.7Amp with a 10-ft. cord. |
| AC Power Requirements | Voltage 90 VAC to 132 VAC Frequency 47 Hz to 63 Hz |
| Fuses | 3 amp fast-blow internal |
| Ground Continuity | Maximum 0.9 ohm |
| Leakage Current | Maximum 100 microamps |
| * Long-term accuracy specified, per IEC 60601-2-24, under the following conditions: | |
| Head height: | 30" |
| Test solution: | Distilled water |
| Environmental: | Ambient temperature |
| Back pressure: | 18 gauge needle |
| IV set: | Model 28034 |

AC Adapter Model 1565C

The AC Adapter Model 1565C has only two connections to AC power, is double insulated as a medical grade power adapter and does not require a connection to earth ground. Model 1565C is compatible with all previously released MedSystem III Infusion Pumps.

The AC adapter Model: 1565C 7.5VDC @ 1.7A includes a 10-foot cord. A ground continuity test is excluded with Model 1565C. The certification to the applicable standards for ElectroMagnetic Compatibility (EMC) has been validated by TÜV America.



AC Adapter Model 1565C - US version

Check-In

This is a Quick Reference Procedure for check-in and configuration of a new and recently serviced MedSystem III. The following check-in and configuration procedures are taken from the current service manual.

- Electrical Safety Test
- Power Tests
- Cassette and Sensor Test
- Patient-side Occlusion Detector Test
- Fluid-side Occlusion Detector Test
- Air-in-Line Test
- Volume Accuracy Test
- Watchdog Audio Test

References (used in conjunction with this document):

The MedSystem III 2865 and 2866 Technical Service Manual.

Physical Inspection

Before unpacking, check the shipping container for damage that may have affected contents. Report any shipping damage to Customer Service.

Check to insure that all accessories are included in the package.

Check for any physical damage to the MedSystem III or accessories. If any is found report it to Customer Service.

Functional Test

Refer to your institutions policies for specific requirements regarding inspection and testing of incoming equipment before use. Recommended functional tests are given in the following pages. As a minimum, the following steps should be performed before use.

- Charge battery for 14 hours.
- Perform electrical safety checks.
- Turn Instrument on to verify normal power-up and operation of LEDS, display and audio.

Check-In Tests

WARNING

For proper grounding, the AC adapter must always be connected to a three-wire outlet. Never operate the MedSystem III from a two-wire, ungrounded outlet.

WARNING

Do not perform any of the following tests while instrument is in use on a patient. Review all precautions in the User Manual before performing these tests.

Check-In tests are recommended prior to clinical use. When a test requires a primed cassette, it is recommended that clean tap water be used for such tests. If any of the functions are not as described in the check procedures, then the pump requires service. Refer to general contact information preceding the introduction of this manual.

NOTE

Upon completion of the Check-In tests, reset the following: Volume Remaining, Time and Rate.

Electrical Safety Test

Equipment required

| Name | Manufacturer | Model Number |
|--------------------------|-----------------------------|----------------------|
| Electrical Safety Tester | Dale Technology Corporation | LT544D or equivalent |

This checks the ground continuity and leakage current of the AC adapter/and the pump, and can only be performed with the AC adapter connected to the pump.

NOTE

The pole clamp is isolated from the internal electronics and, therefore, is not grounded. It should not be used while performing the electrical safety test.

To perform an electrical safety test

1. Refer to the operation manual for the electrical safety tester for the proper setup and measurement technique.
2. Connect the AC adapter to the MedSystem III infusion pump.
3. Plug the AC adapter into the electrical safety tester.
4. Measure the ground continuity and leakage current. Any point of an instrument with an aluminum chassis can be used for testing. A black coated

chassis can only be tested at the uncoated test point, located toward the back of the chassis under the lower housing.

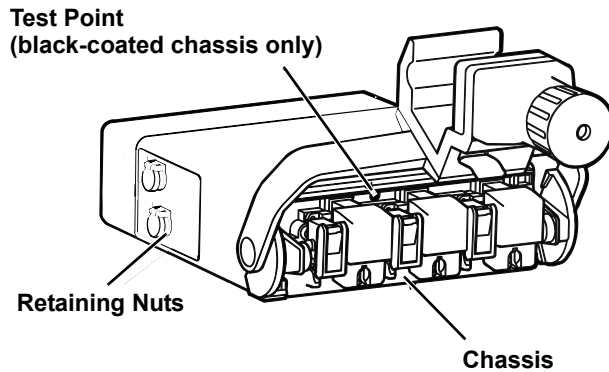

5. Verify the following:
 - Ground continuity not to exceed 0.1 ohm.
 - Leakage current not to exceed 100 μ A.

Power Tests

Charge the MedSystem III for at least one hour prior to performing a power test.

To perform a Power Up test

1. Disconnect the AC adapter from the pump.
2. Remove any cassettes installed in the pump.
3. Turn the pump on and verify proper power-up.

The MedSystem III performs an initial self-test during power-up. If any problems are detected, a fault is indicated.

4. Check the audio and keypad operation by ensuring there is a soft beep for each key pressed.
5. Press any key and ensure the LCD backlight turns on.

NOTE

For a complete memory self-test, instrument should be turned on for a minimum of 18 minutes for the Models 2865 or 2866. It is not necessary for the unit to be pumping to perform this test. If operating on battery power, a cassette must be installed in at least one of the channels and that channel put in standby mode; otherwise, instrument will automatically shut off after five minutes of inactivity.

To perform an AC power test

1. Turn on the pump without the AC adapter attached.
2. Install a primed cassette in each of the three channels.
3. Start all channels (at any rate).
4. Verify that the green LED on each channel flashes during operation.
5. Attach the AC adapter to the MedSystem III.

6. Verify that the pump beeps three times when the connector is installed.
7. Verify that the green plug shaped light on the side connector panel is lit and does not flash if the connector is touched or moved.
8. Verify that the green LEDs for each channel key **A**, **B** or **C** are steadily illuminated. If they are flashing, the MedSystem III is not recognizing that AC power is connected.

To perform the cassette and sensor test

The cassette and sensor test is used to verify the proper functioning of the cassette and latch sensors, as well as the latching mechanisms. Repeat the following procedures for all three channels (A, B and C).

1. With the pump turned off, remove any cassettes that are installed.
2. Turn on the pump.
3. Verify that the pump latch mechanism of each channel returns to the home position at the top of the stroke, nearest to the chassis.
4. Press the channel select key (A, B or C).
5. Press **START STOP**.

An audible two-tone advisory sounds and the highlighted message appears: Install Cassette.

6. Install a primed cassette into the appropriate channel (A, B or C), but do not push the cassette slide clamp into place.

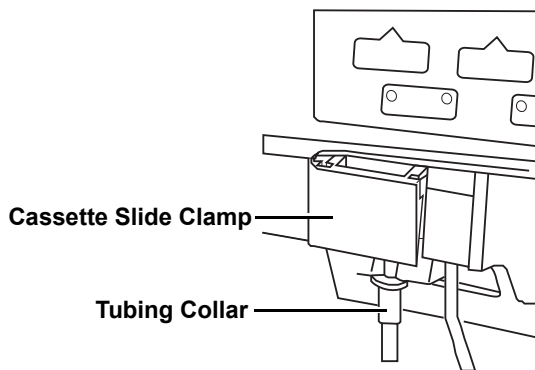

Slide Clamp Out of Position

7. Ensure that there are no air bubbles.
8. Press the **START STOP** again.

A two-tone audible advisory sounds and the message appears: Push Slide Clamp In.

9. Push the cassette slide clamp in and seat the tubing collar in the recess below the cassette.

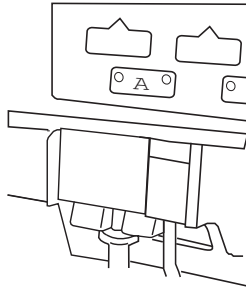

Slide Clamp in Place

Three beeps sound to indicate the correct cassette installation and that fluid is present in the sensor pathway. The cassette should latch easily and smoothly. If the air-in-line sensor detects air when a cassette is installed, a Check Air Sensor advisory appears.

10. Press **START STOP**.

The message Infusing appears on the channel status line.

11. While the channel is pumping, pull out the cassette slide clamp.

A repeating four-beep audible alarm sounds and the red LEDs flashes continuously. Infusion stops and the display indicates a Cassette Not Latched alarm.

12. Remove the cassette.

The alarm display reads Cassette Removed.

13. Reset the alarm by pressing the channel select keys **A**, **B** or **C** for the channel in use, and press **CANCEL**.

To perform the patient side occlusion detector test

The patient side occlusion detector test is used to verify the proper functioning of the alarm which detects occlusion between the Instrument and the patient. Repeat the following steps for each of the three channels, A, B, and C.

1. Configure the MedSystem III in the Controller Pressure Device Type.
2. Prime a set, which contains no filters or check valves, and has macrobore tubing on the patient side.
3. Install the primed set into the Channel Under Test (CUT).
4. Set the infusion rate for 1 ml/h, for the CUT.
5. Press **START STOP** to start infusion.
6. Raise the patient side tubing 2' 2" (66.04 cm) above the cassette.

The CUT should not sound an alarm.

7. Slowly raise the tubing outlet to 3' 8" (96.52 cm) above the cassette.
The CUT should sound an alarm within 10 seconds.
8. After completing steps 1-7 for all three channels configure the MedSystem III in the General Purpose Device Type.

To perform the fluid side occlusion detector test

This test verifies the proper functioning of the alarm which detects occlusion between the pump and the fluid container. Repeat the following steps for each of the three channels, A, B and C.

1. Install a primed set in the selected channel.
2. Start the selected channel at 125 ml/h.
3. Close the roller clamp between instrument and fluid container.
Occlusion should be detected within two minutes. The Standard Display screen displays an alarm for the channel under test and the message Fluid Side Occluded. The red LED in the key for the test channel flashes, and a four beep alarm audibly sounds.
4. Open the roller clamp and press  to reset the alarm.

To perform the air-in-line test

This test verifies the proper functioning of the alarm which detects air in a line. Repeat the following procedure for each of the channels, A, B and C.

1. Disconnect the drip chamber from the solution bottle, or inject a large air bubble into the tubing via the upstream y-site.

NOTE

The injected air bubble size should be approximately twice the threshold value of the air detector plus one milliliter to fill the cassette air trap. For example, if the threshold is 500 microliters, then inject a 2-milliliter air bubble. To determine the threshold value, check the Clinical Configuration settings in MedSystem III.

2. Press  on the selected cassette.

When the bubble is pumped through the cassette, the Standard Display should show an alarm for the channel under test with the message, Air In Line. An audible four-beep alarm sounds and the red LEDs flash.

New Instrument Volume Accuracy Test

Accuracy of fluid delivery is determined by measuring the volume of fluid delivered over a known time period and comparing this to the expected value. To ensure accurate measurements during the test, a volumetric glass burette (class A) must be used to collect the fluid. The infusion time interval must be 180 seconds or greater to minimize measurement errors. During a 180-second test, a one-second error by the operator results in an error of 0.6%.

To setup the test equipment

1. Obtain a new administration set and connect it to a 500-milliliter container that is at least half full.
2. Prime the set and eliminate all air.
3. Connect the apparatus as shown in Test Equipment Setup below. Use a volumetric burette marked in 0.1-milliliter increments (class A glassware).

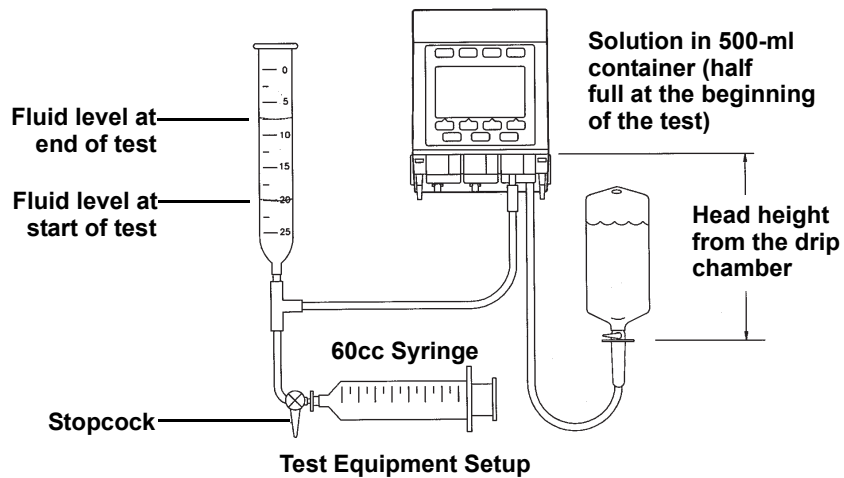



NOTE

Start and end fluid levels should be at a half full level at the start to the test and read from the bottom of the meniscus.

4. Install the cassette to the channel to begin the test.

To perform the new instrument volume accuracy test

1. Power up the Unit Under Test (UUT).
2. Press **MORE OPTIONS**.
3. Press **CONFIG**.
4. Press **SELECT** twice to highlight the Setup line option.
5. Press the ↑ arrow soft key to toggle setting to Yes.
6. Press **ENTER** to accept the setting.
7. Set the meniscus level to 0 in the burette.
8. Press **A** to select Channel-A.
9. Press **SELECT** 4 times to highlight Setup option.
10. Press the ↑ arrow soft key to toggle setting to Select VR and Time.
11. Press **ENTER** to accept setting.
12. Press **SELECT** to highlight Pri VolRem (VR).
13. Press the ↑ arrow soft key until the (VR) is set to 18 ml.

14. Press **ENTER** to accept setting.
15. Press **SELECT** to highlight Pri Time (TR).
16. Press the ↓ arrow soft key until the (TR) is set to 00h 03m.
17. Press **ENTER** to accept setting.
18. Press **CLEAR** to set the Pri Vol Inf (VI) to 0ml.
19. Press **ENTER** to accept setting.
The Primary Rate should read 360 ml/h.
20. Press  to start Channel-A.
Channel-A will run for 3 minutes.
21. Press  within 1 second after the channel goes into KVO alarm.
The volume collect will be between 17.1 ml and 18.9 ml.
22. Repeat steps 7 - 21 for Channels B and C.
23. After testing all three channels repeat steps 1–6 with the exception in step 5 to toggle setting to No.

To perform the watchdog audio test

1. From the Standard Display, press  two times.
A softkey labeled Demo WD appears.
2. Press the Demo WD soft key and follow the directions on the screen for completing the watchdog test.

Cleaning

WARNING

Turn off the MedSystem III and disconnect the power cord from the AC power source before cleaning. Do not spray fluids directly onto the rear case of the Instrument. Do not steam autoclave, EtO sterilize, immerse the MedSystem III or allow fluids to enter the pump case. Failure to follow these instructions may result in an electrical hazard.

CAUTION

- Do not invert instrument during cleaning or rinsing.
- Do not clean instrument without first inspecting the condition of the housings for damage.
- Do not use pressurized air to dry instrument, as the force may move fluid past the moisture seals.
- Do not use organic solvents, ammonia, ammonium-based agents, and/or abrasive cleansers.
- Do not damage valve actuators.
- Do not use sharp or metallic tools to remove residue.

Clean the MedSystem III regularly to maintain the proper working order and optimum performance.

NOTE

If the power cord is permanently attached to instrument, ensure cleaning solution does not enter the connector.

To prepare the MedSystem III for cleaning

1. Unplug the AC adapter power cord from the wall outlet.
2. Disconnect the power cord from the external power connector, on the side of instrument.
3. Inspect the pump's outer surfaces for damage.

CAUTION

Take special care to observe any cracks or punctures in the pump's outer surface that may allow fluid to enter.

Cleaning Solutions

You can use any of the following cleaning solutions to clean the MedSystem III.

- Use solutions of non-abrasive, non-staining detergent (such as, commercially available, alcohol-free, dish washing liquid) well diluted with warm water.
- Use either Cavicide or 10% chlorine bleach and water for disinfecting.
- Rinse with distilled or deionized water.
- Use soft, non-abrasive cloths, soft-bristled brushes and/or non-abrasive, lint-free swabs.

To clean the MedSystem III's lower housing, slide link and latch

1. Wipe the pump's exterior using a cloth dampened with cleaning solution.
2. Remove the lower housing to access the lower assembly by pressing all four black release tabs simultaneously while pulling straight down.

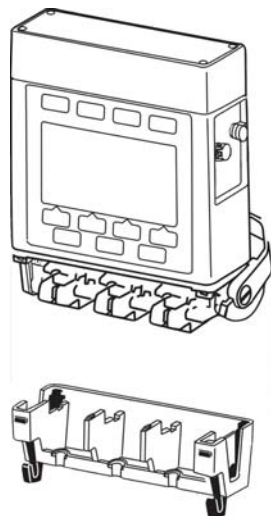

3. Set the pump upright.
4. Clean the slide link and instrument latch mechanism using a small soft bristled brush (or lint-free swab) dampened with the appropriate cleaning solution, as specified above.

NOTE

If dried residue is difficult to remove, or the slide link or pump latch sticks, spray the cleaning solution on the residue and allow it to soak until it can be more easily removed.

5. After removing residue, rinse with a lint-free swab dampened with water. Water may be sprayed on the cleaned surfaces to rinse areas that are difficult to reach with a swab.

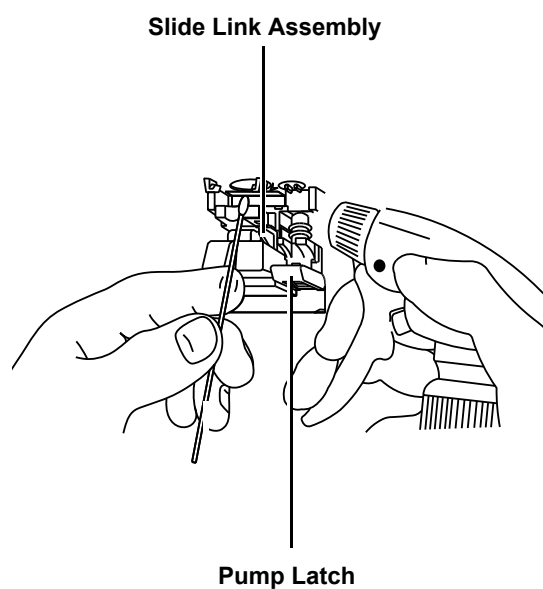

6. Dry with a lint-free swab or cloth, or allow to air dry.

To clean the air sensor recess

CAUTION

Use of abrasives or abrasive cleaners on air sensor recess may cause false Air-in-Line or Check Air Sensor alarms.

NOTE

Air-in-line alarms may occur when dried residue builds up in the air-in-line sensor tubing recess.

1. Inspect the air-in-line sensor module to ensure that there is no separation or breakage of the glued seams.

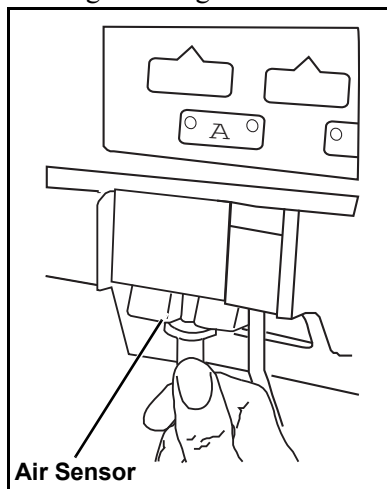
**NOTE**

Defective air-in-line sensor modules must be replaced before using MedSystem III.

2. Place the pump in the upright position.
3. Clean the tubing recess, using a downward motion, with a lint-free swab dampened with the appropriate cleaning solution, as specified in Cleaning Solutions on page 72.
4. Rinse with a lint-free swab dampened with water.
5. Dry with a lint-free swab or allow to air dry.

To clean the Optomodule

CAUTION

Do not use isopropyl alcohol on the optomodule.

1. Place the pump in the upright position.

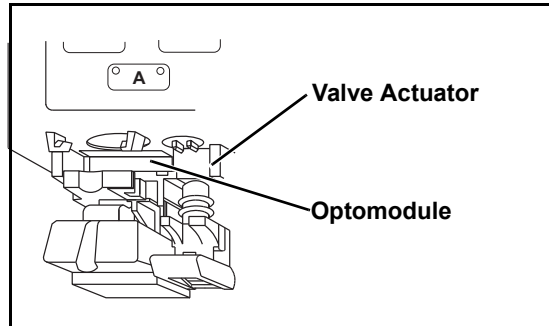

2. Gently clean the optomodule using a lint-free swab dampened with the appropriate cleaning solution, as specified in Cleaning Solutions on page 72.

NOTE

You can spray cleaning solution on difficult to remove residue to help wet and soften the residue for easier removal.

3. After removing residue, gently rinse with a lint-free swab dampened with water.

NOTE

You can spray water on the cleaned surfaces to rinse areas that are difficult to reach with a swab.

4. Gently dry with a lint-free swab or allow to air dry.

To clean the Valve Actuator

WARNING

Use extreme care when cleaning the area around the valve actuators to avoid damage and breakage of the valve actuator tips. Damage or breakage of the valve actuator tips could cause an uncontrolled flow condition.

CAUTION

Do not use isopropyl alcohol to clean the valve actuators.

1. Place the pump in the upright position.

2. Gently clean the valve actuator and actuator seal using a lint-free swab dampened with the appropriate cleaning solution, as specified in Cleaning Solutions on page 72.

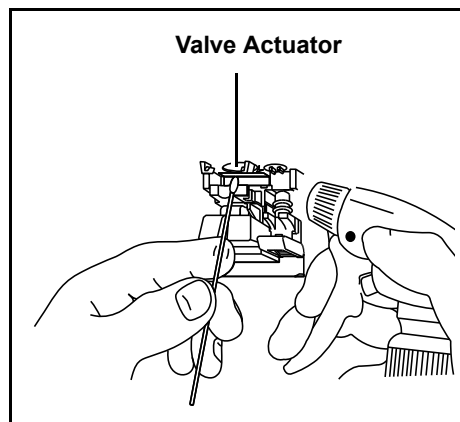
**NOTE**

The cleaning solution may be sprayed on difficult to remove residue to help wet and soften the residue for easier removal.

3. After removing residue, gently rinse with a lint-free swab dampened with water.

NOTE

You can spray water on the cleaned surfaces to rinse areas that are difficult to reach with a swab.

4. Gently dry the area with a lint-free swab or allow to air dry.
5. Once dry, inspect the exposed tips of the valve actuators.

NOTE

A broken valve actuator tip might be supported by the actuator seal and not appear defective. Lightly push the valve actuators tips from side to side with a dry lint-free swab. If a valve actuator tip is not rigid, it is broken and must be replaced before using the pump.

Inspection Requirements

WARNING

Failure to perform the recommended inspections may result in improper pump operation.

To ensure that the MedSystem III remains in good operating condition, both regular and periodic inspections are required. Any MedSystem III that does not meet listed specifications should be serviced.

Regular inspections consist of performing the procedures described in the Basic Operation and Cleaning sections of this manual before use of MedSystem III. Regular inspections are not covered under any contract or agreement offered by CareFusion, and must be performed by the user.

When programming infusions verify that the display:

- Is complete and not blurred.
- Reads the same as described in this manual.
- Responds with the intended function for that key press.

NOTE

Detailed instructions for performing periodic inspections and maintenance can be found in the MedSystem III Technical Service Manual and in supplemental service bulletins.

Periodic inspections must be performed every 12 months. A service agreement may be obtained from CareFusion, for the performance of all required periodic inspections.

The periodic inspections must be performed in accordance with CareFusion requirements and guidelines. Customers within the United States and Canada should note that these inspections are also intended to complement the intent of Joint Commission on the Accreditation of Healthcare Organizations requirements.

Service Information

WARNING

The MedSystem III case should only be opened by qualified personnel using proper grounding techniques. Prior to performing maintenance, disconnect from AC power.

WARNING

During servicing, the instruments configuration settings might be reset to the factory defaults. Qualified hospital/facility personnel are responsible for checking in the MedSystem III and ensuring the current hospital configurations and/or Drug List.

If a MedSystem III shows evidence of damage in transit, notify the carrier's agent immediately. Do not return damaged equipment to the factory before the carrier's agent has authorized repairs.

If the MedSystem III fails to respond as described in this document and the cause cannot be determined, do not use the pump. Contact qualified CareFusion service personnel.

If it is necessary to return the pump for service, obtain a return authorization number prior to shipment. Carefully package instrument (preferably in the original packaging), reference the return authorization information, and return it to appropriate service or distribution center. CareFusion does not assume any responsibility for loss of, or damage to returned instruments while in transit.

Technical Support

Technical support, service information, applications, and manuals may be obtained by contacting a CareFusion representative.

When submitting any request for service, include:

- Model number
- The MedSystem III serial number
- A description of difficulty experienced
- Instrument settings
- Administration set/lot number
- Solution(s) used
- Message displayed at time of difficulty

Warranty

CareFusion warrants that:

- A. Each new Alaris System product is free from defects in material and workmanship under normal use and service for a period of one (1) year from the date of delivery by CareFusion to the original purchaser.
- B. The battery and each new accessory is free from defects in material and workmanship under normal use and service for a period of ninety (90) days from the date of delivery by CareFusion to the original purchaser.

If any product requires service during the applicable warranty period, the purchaser should communicate directly with CareFusion to determine the appropriate repair facility. Except as provided otherwise in this warranty, repair or replacement will be carried out at CareFusion's expense. The product requiring service should be returned promptly, properly packaged and postage prepaid by purchaser. Loss or damage in return shipment to the repair facility shall be at purchaser's risk.

In no event shall CareFusion be liable for any incidental, indirect or consequential damages in connection with the purchase or use of any Alaris System product. This warranty shall apply solely to the original purchaser. This warranty shall not apply to any subsequent owner or holder of the product. Furthermore, this warranty shall not apply to, and CareFusion shall not be responsible for, any loss or damage arising in connection with the purchase or use of any Alaris System product which has been:

1. repaired by anyone other than an authorized CareFusion Service Representative;
2. altered in any way so as to affect, in CareFusion's judgment, the product's stability or reliability;
3. subjected to misuse or negligence or accident, or which has had the product's serial or lot number altered, effaced or removed; or
4. improperly maintained or used in any manner other than in accordance with the written instructions furnished by CareFusion.

This warranty is in lieu of all other warranties, express or implied, and of all other obligations or liabilities of CareFusion, and CareFusion does not give or grant, directly or indirectly, the authority to any representative or other person to assume on behalf of CareFusion any other liability in connection with the sale or use of Alaris System products.

CAREFUSION DISCLAIMS ALL OTHER WARRANTIES, EXPRESS OR IMPLIED, INCLUDING ANY WARRANTY OF MERCHANTABILITY OR OF FITNESS FOR A PARTICULAR PURPOSE OR APPLICATION.

See packing inserts for international warranty, if applicable.

Appendix A

Trumpet and Start-Up Curves

In the MedSystem III, as with all infusion systems, the action of the pumping mechanism and variations in individual administration sets cause short-term fluctuations in rate accuracy. The following curves show typical performance of the system in two ways:

- the accuracy during various time periods over which fluid delivery is measured (trumpet curves),
- and -
- the delay in onset of fluid flow when infusion commences (start-up curves).

Trumpet curves are named for their characteristic shape. They display discrete accuracy data averaged over particular time periods or observation windows, not continuous data versus operating time. Over long observation windows, short-term fluctuations have little effect on accuracy as represented by the flat part of the curve. As the observation window is reduced, short-term fluctuations have greater effect as represented by the mouth of the trumpet. Knowledge of system accuracy over various observation windows may be of interest when certain drugs are being administered.

Because the clinical impact of short-term fluctuations on rate accuracy depends on the half-life of the drug being infused and on the degree of intravascular integration, the clinical effect cannot be determined from the trumpet curves alone. Knowledge of the start-up characteristics should also be considered.

The start-up curves represent continuous flow rate versus operating time for two hours from the start of the infusion. They exhibit the delay in onset of delivery due to mechanical compliance and provide a visual representation of uniformity. Trumpet curves are derived from the second hour of this data.

Long-term accuracy of the MedSystem III in combination with the specified administration set is considered to be within 5%.

Flow Characteristics under Varying Delivery Conditions

Effects of Pressure Variations

Under conditions of +100mmHg pressure, the MedSystem III typically exhibits a long term accuracy offset of approximately -0.4%.

Under conditions of -100mmHg pressure, the MedSystem III typically exhibits no significant offset in long term accuracy.

Resulting Trumpet observation points typically track that of accuracy. Therefore, no significant change in short term variations result under negative solution container height conditions.

Effects of Negative Solution Container Heights

With a negative head height of -0.5 meters, the MedSystem III typically exhibits a long term accuracy offset of approximately -0.4%.

Resulting Trumpet observation points typically track that of accuracy. Therefore, no significant change in short term variations result under back pressure conditions.

Pressure Mode

The following graphs represent tests performed per IEC/FDIS 60601-2-24, Particular Requirements for Safety of the Instruments and Controllers using the MedSystem III with Model 28034 IV sets, 76cm of head height and no back pressure.

Start-up 1ml/hr

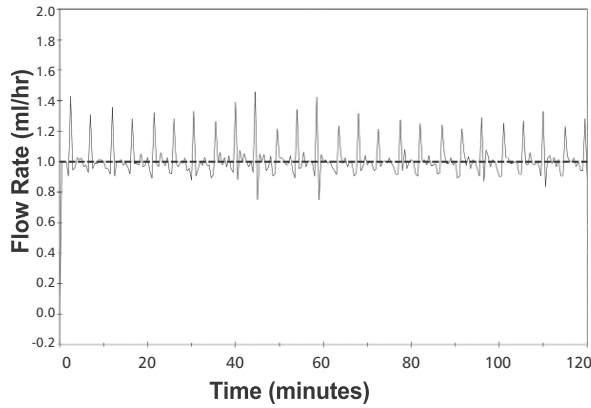

Start-up 25 ml/hr

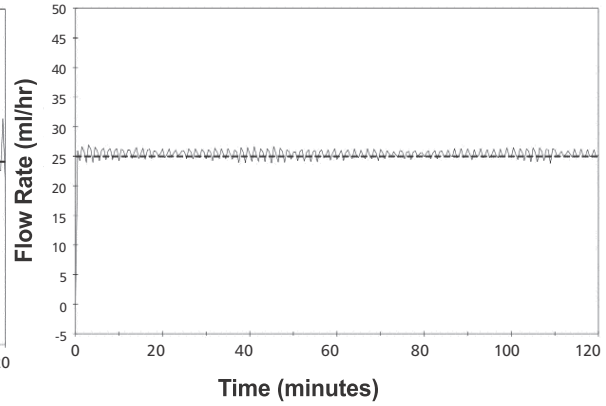

Trumpet: 1ml/hr (Initial)

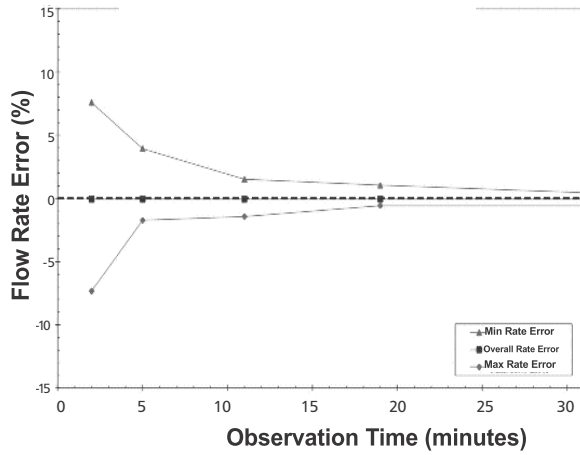

Trumpet: 1ml/hr (48 Hours)

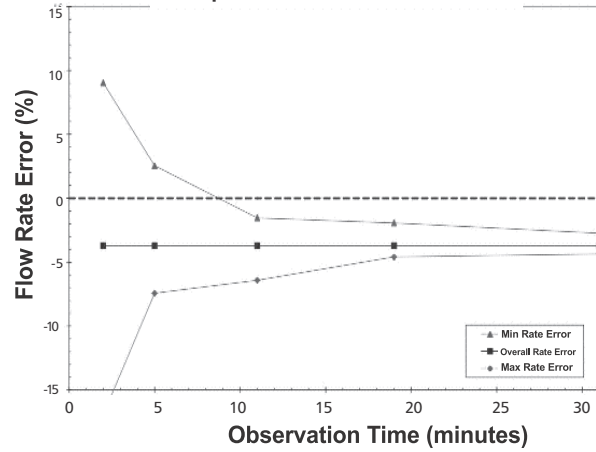

Trumpet: 25 ml/hr (Initial)

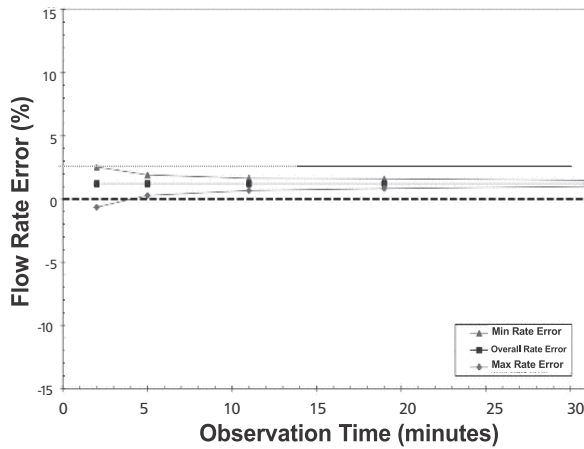

Trumpet: 25 ml/hr (48 Hours)

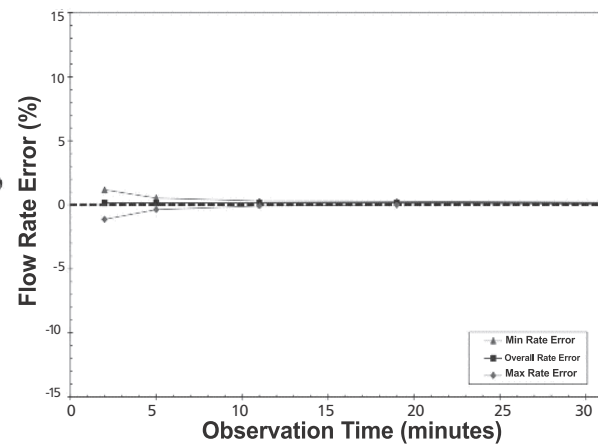

Electromagnetic Environment

FCC Notice

This equipment has been tested and found to comply with limits for a Class B digital device pursuant to Part 18 of the FCC Rules.

- These limits are designed to provide reasonable protection against harmful interference when the equipment is operated in a commercial environment.
- This equipment generates, uses, and can radiate radio frequency energy and, if not installed and used in accordance with the instruction manual, may cause harmful interference to radio communications. Operation of this equipment in a residential area is likely to cause harmful interference in which case the user will be required to correct the interference at users own expense.

The authority to operate this equipment is conditioned by the requirement that no modifications will be made to the equipment unless the changes or modifications are expressly approved by CareFusion.

Canadian Notice (Avis Canadien)

This Class B digital apparatus meets all requirements of the Canadian Interference-Causing Equipment Regulations.

Cet appareil numérique de la Classe B respecte toutes les exigences du Règlement sur le matériel brouilleur du Canada.

CAUTION

Any changes or modifications not expressly approved by the party responsible for compliance could void the user's authority to operate the equipment.

EMC Tables

The following information is to be provided to the User as directed by IEC 60601-1-2:2001, a Collateral Standard for Electromagnetic Compatibility. The information provided herein provide certain Warnings and Caution text that must be included in the User Manual and the attached Tables of informative information as to the emission and immunity levels of the testing performed.

| Table 1 Guidance and Manufacturer's Declaration - Electromagnetic Emissions | | |
|---|-------------------|---|
| The MedSystem III is intended for use in the electromagnetic environment specified below. Customer or user of MedSystem III should assure that it is used in such an environment. | | |
| Emissions Test | Compliance | Electromagnetic Environment - Guidance |
| CISPR 11 RF Emissions | Group 1 | The MedSystem III uses RF energy only for its internal function in the normal product offering. An option is available for a low power wireless network card. If the following icon appears on the product, it has a low power RF transmitter installed, refer to the User Manual for guidance. <div style="text-align: center;">  </div> RF emissions are very low and are not likely to cause any interference in nearby electronic equipment. |
| CAUTION The MedSystem III® Infusion System is intended for use under the supervision of healthcare professionals only. In a domestic environment, this system may cause radio interference. Reorienting, relocating, or shielding the system, or filtering the connection to the public mains network, are examples of steps that can be taken to reduce or eliminate interference. | | |
| CISPR 11 RF Emissions | Class B | The MedSystem III is suitable for use in all establishments, including domestic establishments and those directly connected to the public low-voltage power supply network that supplies buildings used for domestic purposes. |
| IEC 61000-3-2 Harmonic Emissions | Class A | |
| IEC 61000-3-2 Voltage Fluctuations, Flicker Emissions | Complies | |

| Table 2 Guidance and Manufacturer’s Declaration—Electromagnetic Immunity | | | |
|---|--|--|---|
| The MedSystem III is intended for use in the electromagnetic environment specified below. Customer or user of MedSystem III should assure that it is used in such an environment. | | | |
| Immunity Test | IEC 60601-1-2 Test Level | Compliance Level | Electromagnetic Environment—Guidance |
| IEC 61000-4-2 Electro-Static Discharge (ESD) | ±6 kV contact ±8 kV air | ±8 kV contact (NOTE2) ±15 kV air (NOTE2) | The floors should be wood, concrete, or ceramic tile. If the floors are covered with synthetic material, the relative humidity should be at least 30%. If connector testing exemption is used, the following symbol for ESD sensitivity appears adjacent to each connector. Caution – Do Not Touch.  |
| IEC 61000-4-4 Electrical Fast Transient, Burst (EFT) (NOTE 3) | ±2 kV for power supply lines ±1 kV for input/output lines | ±2 kV for power supply lines ±1 kV for input/output lines | Mains power quality should be that of a typical commercial or hospital environment. |
| IEC 61000-4-5 Power Line Surge (NOTE 3) | ±1 kV differential mode ±2 kV common mode | ±1 kV differential mode ±2 kV common mode | Mains power quality should be that of a typical commercial or hospital environment. |
| IEC 61000-4-8 Power Frequency Magnetic Field (50/60 Hz) | 3 A/m | 400 A/m 50 Hz (NOTE2) 400 A/m 60 Hz (NOTE2) | Power frequency magnetic fields should be at levels characteristic of a typical location in a typical commercial or hospital environment. |
| IEC 61000-4-11 Voltage Dips, Short Interruptions, and Voltage Variations (NOTE 3) | <5% UT (NOTE 1) (>95% dip in UT) for 0.5 cycle | <5% UT (>95% dip in UT) for 0.5 cycle | Mains power quality should be that of a typical commercial or hospital environment. If the user of the MedSystem III requires continued operation during power mains interruptions, it is recommended that the MedSystem III be powered from an uninterruptible power supply or a battery. The MedSystem III does employ an internal short duration battery. |
| | 40% UT (60% dip in UT) for 5 cycles | 40% UT (60% dip in UT) for 5 cycles | |
| | 70% UT (30% dip in UT) for 25 cycles | 70% UT (30% dip in UT) for 25 cycles | |
| | <5% UT (>95% dip in UT) for 5 sec | <5% UT (>95% dip in UT) for 5 sec | |
| NOTE 1—UT is the AC mains voltage prior to application of the test level. NOTE 2—Compliance levels raised by IEC 60601-2-24. NOTE 3 – Performed at the Minimum and Maximum Rated Input Voltage. | | | |

**Table 3
Guidance and Manufacturer's Declaration—Electromagnetic Immunity
Life Support Equipment**

The MedSystem III is intended for use in the electromagnetic environment specified below. Customer or user of MedSystem III should assure that it is used in such an environment.

| Immunity Test | IEC 60601-1-2 Test Level | Compliance Level | Electromagnetic Environment—Guidance |
|--------------------------------------|---------------------------------|-------------------------|---|
| IEC 61000-4-6 Conducted RF | 3 V rms 150 kHz to 80 MHz | 10 V rms (NOTE 3) | Portable and mobile RF communications equipment should be used no closer to any part of the MedSystem III, including cables, than the recommended separation distance calculated from the equation applicable to the frequency of the transmitter. Recommended Separation Distance $d = \left[\frac{12}{V_2} \right] \sqrt{P}$ $d = \left[\frac{12}{E_1} \right] \sqrt{P} \text{ 80 MHz to 800 MHz}$ $d = \left[\frac{12}{E_1} \right] \sqrt{P} \text{ 80 MHz to 2.5 GHz}$ where P is the maximum output power rating of the transmitter in watts (W) according to the transmitter manufacturer and d is the recommended separation distance in meters (m). ^a Field strengths from fixed RF transmitters, as determined by an electromagnetic site survey, ^b should be less than the compliance level in each frequency range. ^c Interference may occur in the vicinity of equipment marked with the following symbol:  |
| IEC 61000-4-3 Radiated RF | 3 V/m 80 MHz to 2.5 GHz | 10 V/m (NOTE 3) | |

NOTE 1—At 80 MHz and 800 MHz, the higher frequency range applies.

NOTE 2—These guidelines may not apply in all situations. Electromagnetic propagation is affected by absorption and reflection from structures, objects, and people.

NOTE 3—Compliance levels raised by IEC 60601-2-24.

| Table 3 Guidance and Manufacturer's Declaration—Electromagnetic Immunity Life Support Equipment | | | |
|--|--------------------------|------------------|--------------------------------------|
| The MedSystem III is intended for use in the electromagnetic environment specified below. Customer or user of MedSystem III should assure that it is used in such an environment. | | | |
| Immunity Test | IEC 60601-1-2 Test Level | Compliance Level | Electromagnetic Environment—Guidance |
| a The compliance levels in the ISM frequency bands between 150 kHz and 80 MHz and in the frequency range 80 MHz to 2.5 GHz are intended to decrease the likelihood that mobile/portable communications equipment could cause interference if it is inadvertently brought into patient areas. For this reason, an additional factor of 10/3 is used in calculating the recommended separation distance for transmitters in these frequency ranges. b Field strengths from fixed transmitters, such as base stations for radio (cellular/cordless) telephones and land mobile radios, amateur radio, AM and FM radio broadcast, and TV broadcast cannot be predicted theoretically with accuracy. To assess the electromagnetic environment due to fixed RF transmitters, an electromagnetic site survey should be considered. If the measured field strength in the location in which the MedSystem III is used exceeds the applicable RF compliance level above, the MedSystem III should be observed to verify normal operation. If abnormal performance is observed, additional measures may be necessary, such as re-orienting or relocating the MedSystem III. c Over the frequency range 150 kHz to 80 MHz, field strengths should be less than 10 V/m. | | | |

| Table 4 Recommended Separation Distances For LIFE SUPPORT Equipment between portable and mobile RF communications equipment and the MedSystem III | | | | |
|--|--|--|---|--|
| The MedSystem III is intended for use in an electromagnetic environment in which radiated RF disturbances are controlled. Customer or user of the MedSystem III can help prevent electromagnetic interference by maintaining a minimum distance between portable and mobile RF communications equipment (transmitters) and the MedSystem III as recommended below, according to the maximum output power of the communications equipment. | | | | |
| Rated Maximum Output Power of Transmitter W | Separation Distance According to Frequency of Transmitter (m) | | | |
| | 150 kHz to 80 MHz Outside ISM bands $d = \left[\frac{3.5}{V_1} \right] \sqrt{P}$ | 150 kHz to 80 MHz In ISM bands $d = \left[\frac{12}{V_2} \right] \sqrt{P}$ | 80 MHz to 800 MHz $d = \left[\frac{12}{E_1} \right] \sqrt{P}$ | 800 MHz to 2.5 GHz $d = \left[\frac{23}{E_1} \right] \sqrt{P}$ |
| 0.01 | 0.04 | 0.12 | 0.12 | 0.23 |
| 0.1 | 0.11 | 0.38 | 0.38 | 0.73 |
| 1 | 0.35 | 1.20 | 1.20 | 2.30 |

Table 4
Recommended Separation Distances For LIFE SUPPORT Equipment
between portable and mobile RF communications equipment and the
MedSystem III

The MedSystem III is intended for use in an electromagnetic environment in which radiated RF disturbances are controlled.

Customer or user of the MedSystem III can help prevent electromagnetic interference by maintaining a minimum distance between portable and mobile RF communications equipment (transmitters) and the MedSystem III as recommended below, according to the maximum output power of the communications equipment.

| Rated Maximum Output Power of Transmitter W | Separation Distance According to Frequency of Transmitter (m) | | | |
|--|--|--|--|---|
| | 150 kHz to 80 MHz Outside ISM bands $d = \left[\frac{3.5}{V_1} \right] \sqrt{P}$ | 150 kHz to 80 MHz In ISM bands $d = \left[\frac{12}{V_2} \right] \sqrt{P}$ | 80 MHz to 800 MHz $d = \left[\frac{12}{E_1} \right] \sqrt{P}$ | 800 MHz to 2.5 GHz $d = \left[\frac{23}{E_1} \right] \sqrt{P}$ |
| 10 | 1.11 | 3.80 | 3.80 | 7.30 |
| 100 | 3.50 | 12.00 | 12.00 | 23.0 |

For transmitters rated at a maximum output power not listed above, the recommended separation distance d in meters (m) can be determined using the equation applicable to the frequency of the transmitter, where P is the maximum output power rating of the transmitter in watts (W) according to the transmitter manufacturer.

NOTE 1—At 80 MHz and 800 MHz, the separation distance for the higher frequency range applies.

NOTE 2—The ISM (Industrial, Scientific, and Medical) bands between 150 kHz and 80 MHz are 6.765 MHz to 6.795 MHz; 13.553 MHz to 13.567 MHz; 26.957 MHz to 27.283 MHz; and 40.66 MHz to 40.70 MHz.

NOTE 3—An additional factor of 10/3 is used in calculating the recommended separation distance for transmitters in the ISM frequency bands between 150 kHz and 80 MHz and in the frequency range 80 MHz to 2.5 GHz to decrease the likelihood that mobile/portable communications equipment could cause interference if it is inadvertently brought into patient areas.

NOTE 4—These guidelines may not apply in all situations. Electromagnetic propagation is affected by absorption and reflection from structures, objects, and people.

Standards

The MedSystem III Infusion System has been assessed and complies with the following standards:

IEC EN 60601-1, including amendments A1 and A2; IEC EN 60601-2-24; CISPR 11, Group 1, Class B Emissions; IEC EN 60601-1-2; UL 60601-1, CAN/CSA No. 601.1-M90

Glossary

1° Pri

Primary infusion

2° Sec

Secondary infusion

a

am

AAMI

American Association of Medical Instrumentation

ABS

acrylonitrile-butadiene-styrene

AC

alternating current (electrical power)

BatLog

Battery History Log

Calc

Calculator

CalcOff
Calculator Off

CalcOn
Calculator On

ClrAir
Clear Air

cm
centimeter

Contrst
Contrast

COMM
Communications Port

Conc
Concentration

Config
Configuration

CP
Controller Pressure

CSA
Canadian Standards Association

DemoWD
Demonstrate Watchdog

DI
Dose Infused

ECG
Electrocardiogram

ES
Electrostatic

FMS
Field Maintenance Software

Gm
gram

GP
General Purpose

GP II

General Purpose II

h

hour

Hz

Hertz

in.

inch

I.D.

identification

IEC

International Electrotechnical Commission

Inf

infused

IV

intravenous

JCAHO

Joint Commission on the Accreditation of Health Care Organizations

K

1,000 for numbers 10,000 or greater

KG; kg

kilogram

KVO

keep vein open

LB;lb

pound

mcg

microgram

mEq

milliequivalent

mg

milligram

min; mn

minute

ml
milliliter

mMol
millimole

mUn
milliunit

µl
microliter

N/A
not applicable

Neontl
Neonatal

NextPg
Next Page

Ng
Nanogram

NiCd
nickel-cadmium

OR
Operating Room

OR II
Operating Room II

p
pm

Pri
Primary

psi
pounds per square inch

Sec
Secondary

Std Disp
Standard Display

STNDBY
Standby

TotVol

Total Volume

TR

time remaining

UL

Underwriters Laboratories, Inc.

Un

unit

V

Volts

VI

volume infused

Vol

volume

VolRem

volume remaining

VR

volume remaining

Wt

weight

- Notes -