

Model 8712009
8712109
8712309
8712309L
8712409
8712509

Package Includes:

- 1 - Exterior Faceplate
- 1 - Interior Faceplate
- 1 - User Guide
- 2 - Keys
- 1 - Strike Plate
- 1 - Mounting Plate
- 1 - Latch
- 1 - 3/8" Screws
- 2 - 5/16" Screws
- 2 - 1" Screws
- 5 - 3/4" Screws
- 2 - Mounting Post

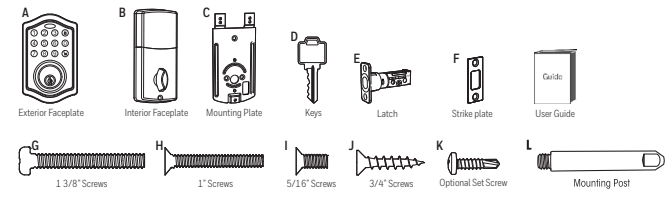

Please carefully check the above list to confirm all items have been received. If any items are missing, please contact Consumer Assistance. (See page for contact information)

Read this manual carefully before installing and operating!

1 Installation Overview

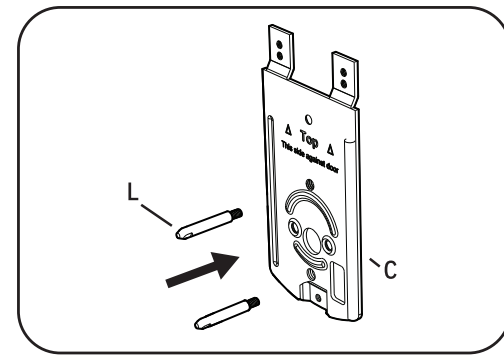
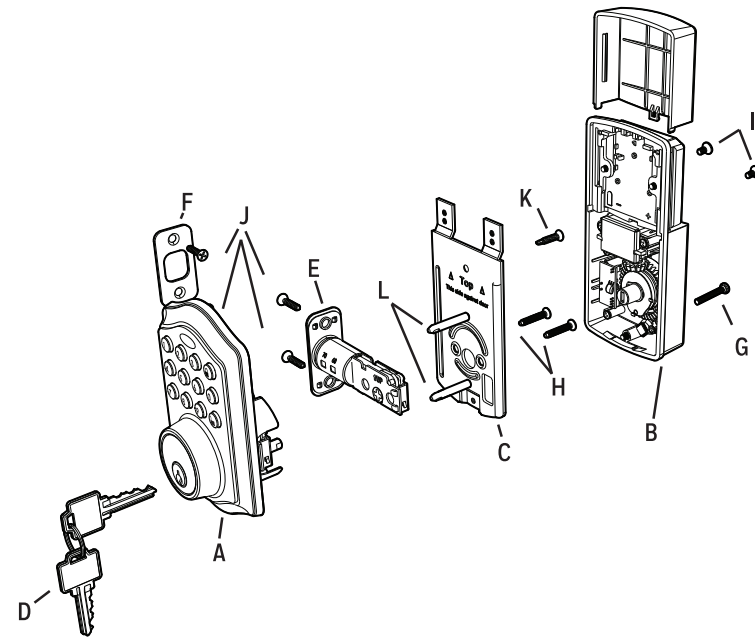

NOTE: Screw Mounting Post (L) into holes on Mounting Plate (C)

2 Preparing Door

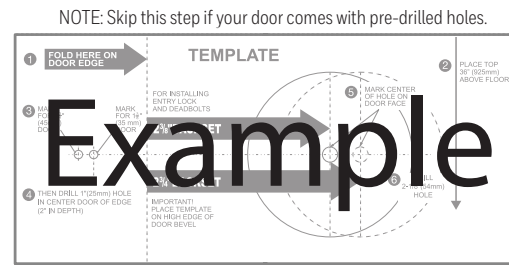

Refer to Template included for Door Prep Instructions

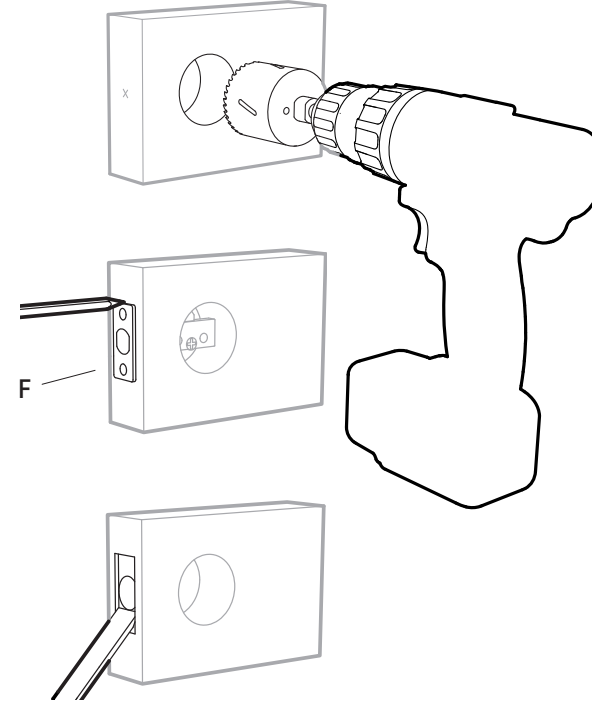

3 Install Enclosed Latch and Strike Plate

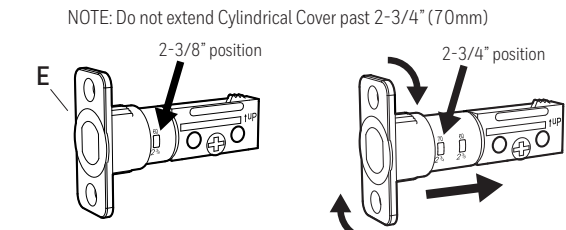

NOTE: Do not extend Cylindrical Cover past 2-3/4" (70mm)

TO CONVERT FROM 2-3/8" (60mm) BACKSET TO 2-3/4" (70mm) BACKSET

1. Hold latch with numbers facing forward and thumb pressing on the bolt.
2. Rotate the cylinder cover clockwise.
3. Pull and twist the extension plate all the way out.
4. Rotate the cylinder counter clockwise so that the marking aligns with the 2-3/4" position indicator.

Deadbolt Latch Must Be Retracted During Installation

Programming Instructions

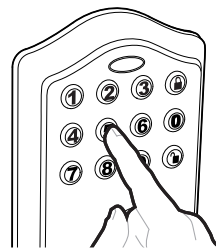
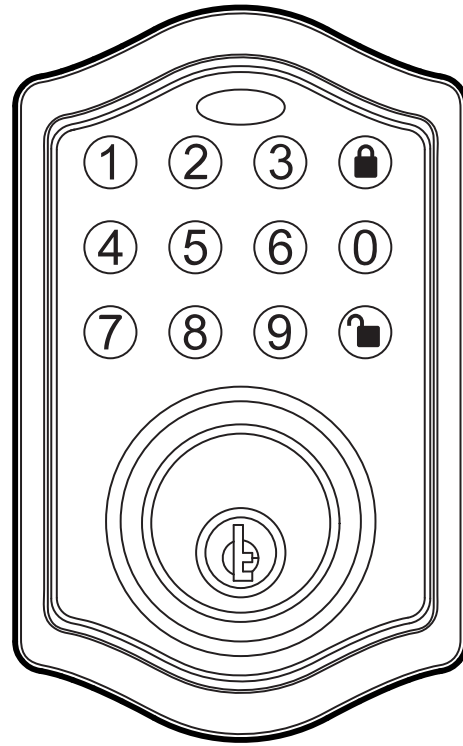

! Complete all the programming steps in the programming mode within 5 seconds
Do not press keypad until keypad stops illuminating

1 Creating Administrator Code

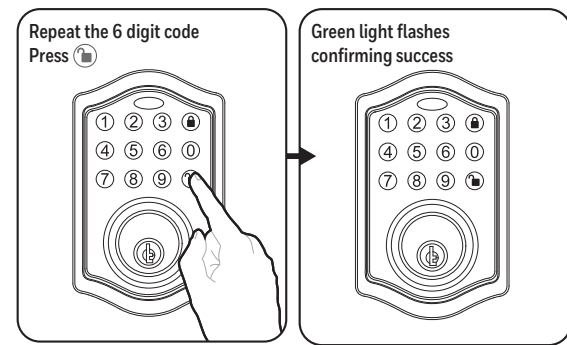
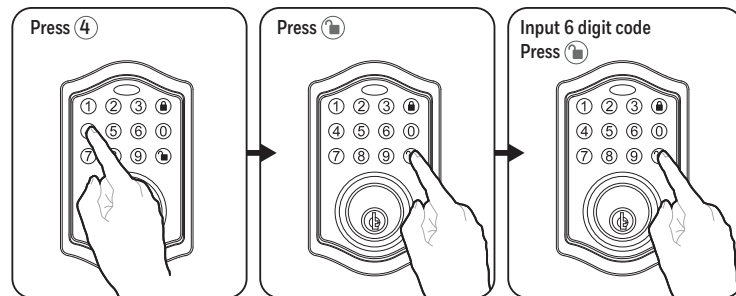
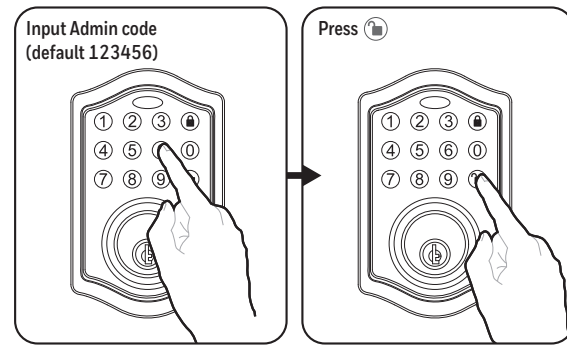

2 Adding a User Code

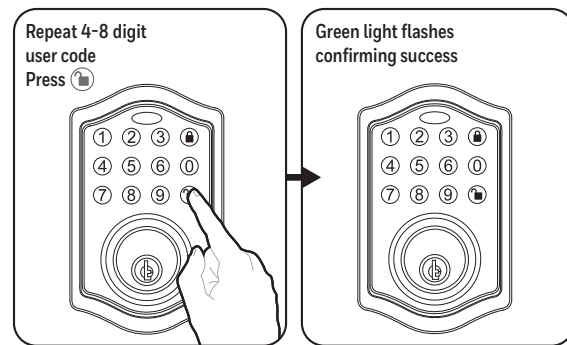
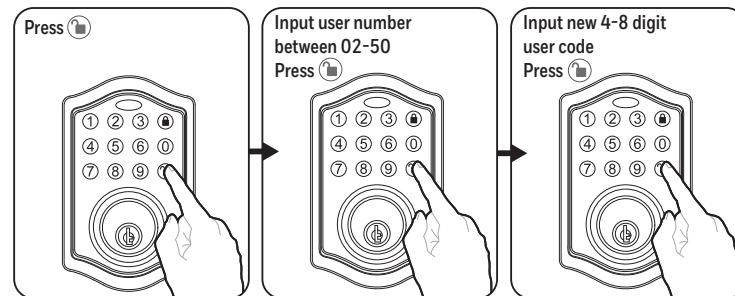
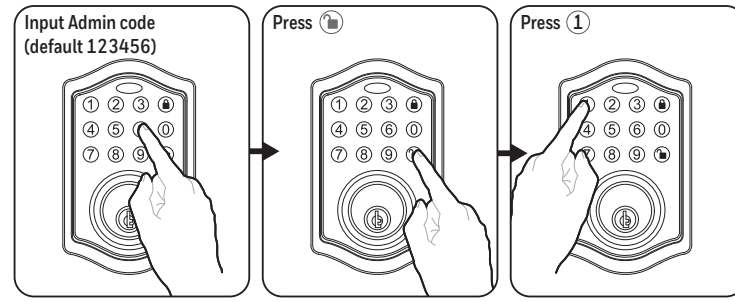

3 Unlocking Door with User Code

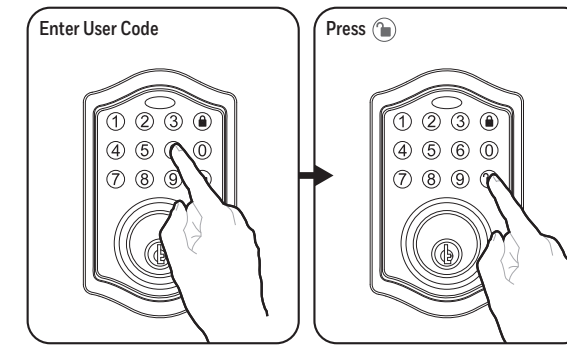

PROGRAMMING RECORD

My Codes:	Date Created
Programming Code	_____ (6 digits) / /
User Code 02	_____ (4-8 digits) / /
User Code 03	_____ (4-8 digits) / /
User Code 04	_____ (4-8 digits) / /
User Code 05	_____ (4-8 digits) / /
User Code 06	_____ (4-8 digits) / /
User Code 07	_____ (4-8 digits) / /
User Code 09	_____ (4-8 digits) / /
User Code 10	_____ (4-8 digits) / /
User Code 11	_____ (4-8 digits) / /
User Code 12	_____ (4-8 digits) / /
User Code 13	_____ (4-8 digits) / /
User Code 14	_____ (4-8 digits) / /
User Code 15	_____ (4-8 digits) / /
User Code 16	_____ (4-8 digits) / /
User Code 17	_____ (4-8 digits) / /
User Code 18	_____ (4-8 digits) / /

4 Deleting a User Code

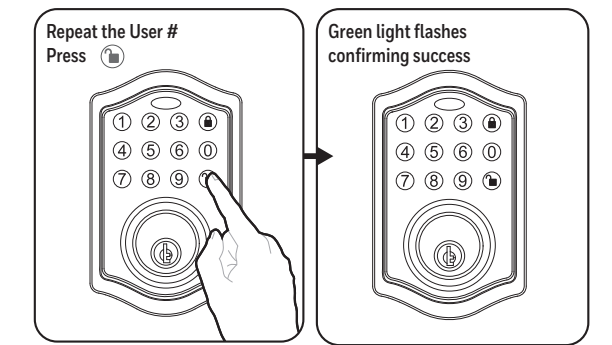
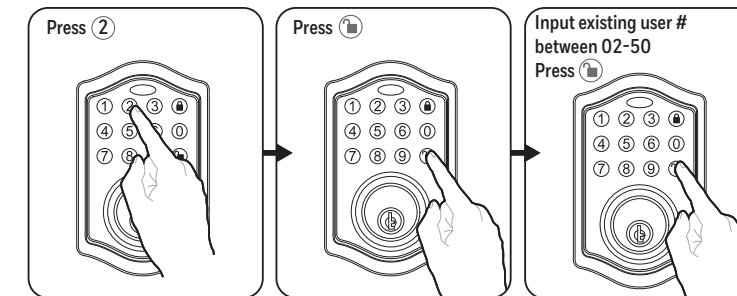
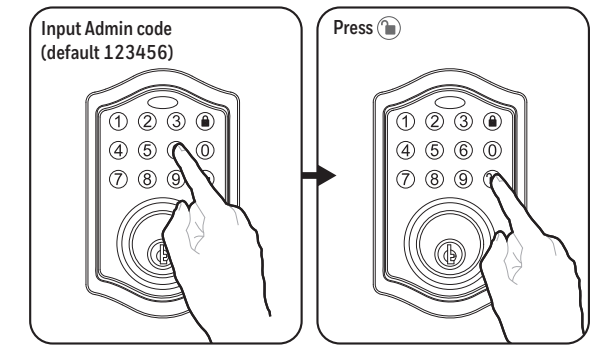

5 Deleting All User Codes

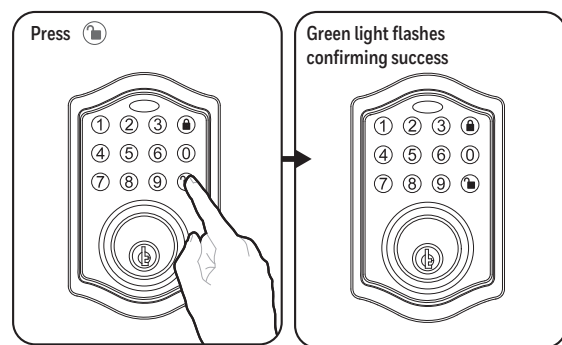
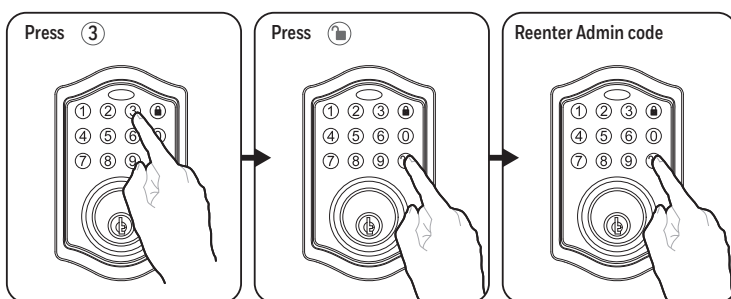
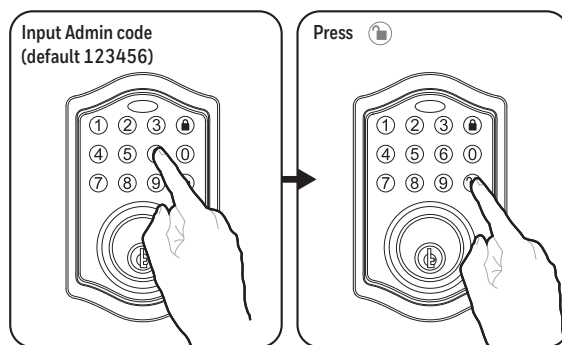

6 Additional Programming Functions

Programming Symbols

- Lock / Clear
- Unlock / Programming
- Administrator Code

Automatic Lock Function

SET OR CANCEL AUTO LOCK

You can set the lock to automatically close after each time the lock is opened. Time value range = 20 - 900 seconds, enter the following:

Set Auto Lock: 5 Time Value

Hear 1 beep and Light Indicator illuminates green.

To cancel Auto Lock set the time to 00, enter the following:

Cancel Time Value Auto Lock: 5 00

Hear 1 beep and Light Indicator illuminates green.

TEMPORARILY DISABLE:

While in Auto-Lock mode, unlock door using , within 10 seconds you must turn the locking knob by hand to the locked position, wait more than 2 seconds then turn the locking knob back to the unlock position. The Auto-Lock mode is now disabled.

RESTORE:

To restore the Auto-Lock function, turn the locking knob by hand to the locked position, wait more than 2 seconds or press the Lock button on the keypad.

Vacation Mode

With Vacation Mode enabled, the system enters into low-power consumption mode. During this mode, all buttons and functions will be disabled until they are re-enabled.

ENABLE:

10 1

Once the door is locked then vacation mode will be engaged and all buttons and functions will be disabled

DISABLE:

To disable the Vacation Mode you must press and hold for more than 3 seconds, then input followed by to unlock the door. Vacation Mode is now disabled.

! NOTE: If you only press the for more than 3 seconds but do not input , the system will remain in Vacation Mode.

Secure Lock-out period

Warning sounds and LED flashes red after 4 incorrect code attempts; Keypad shuts down for 60 seconds.

7 Additional Programming Functions

SOUND ON AND OFF

You can "mute" or turn the "sound on" on your lock by entering the following. (Factory setting is sound on).

6 1 or 2

1 = Sound Off
2 = Sound On

Sound Off (1) - Light Indicator illuminates green.

Sound On (2) - Hear 1 beep and Light Indicator illuminates green.

Restore Factory Settings

To reset the lock to the original factory settings including the Programming Code and all User Codes follow these steps:

1. Remove one battery for 10 seconds.
2. Reinsert the battery and wait for a long and short beep
3. Press 3 times within 3 seconds.
4. The lock will beep and the light indicator will turn green.

Low Battery Warning

Beeps and LED flashes red 7 times. Replace with good quality alkaline batteries.

Note: Removing batteries does not erase active Administrator or User Codes.

Consumer Friendly Message Guide

Unlock / Valid programming:	1 long beep and LED illuminates green
Lock:	2 short beeps and LED illuminates red
Invalid Programming:	2 short beeps and LED flashes red twice
Low Voltage:	Short beeps and LED flashes red seven times
Super Low Voltage:	4 short beeps and LED flashes red four times
4 Incorrect code entry attempts:	2 short beeps and LED illuminates red each attempt
Power on:	1 long beep and 1 short beep and LED illuminates green
Chip Reset:	1 long beep and 1 short beep and LED illuminates green (may occur several times or once in a while)
Lock Error:	3 long beeps LED flashes red three times
Repeat operation after Lock Error:	2 short beeps three times LED flashes red six times

Troubleshooting

Issue	Solution
Interior Knob will not turn	Knob or vertical tailpiece is installed in incorrect position. • Remove Interior Assembly and reposition the Interior Knob. With the Deadbolt Latch retracted verify that the tailpiece is vertical.
Lock will not function electronically	• Check that all batteries are fresh high quality Alkaline Batteries. • Check for proper polarity (+ -) of all batteries. • Check that the Control Wire is attached to the Interior Assembly and not damaged. • Check each wire for loose or disconnected wires. • Disconnect the wiring harness and reconnect the wiring harness.
Lock gives error signal when opening or locking and Deadbolt Latch will not extend or retract completely when door is closed	• Unlock door using Key or Interior Knob. While door is open, check that the Deadbolt Latch operates smoothly. • Check for proper alignment of the strike plate, adjust as needed to assure there is no binding against the Deadbolt Latch. • Make sure tail piece is in the vertical position and straight up and down.
Deadbolt Latch is sticking	Installation screws of the lock may be too tight and have to be loosened. • Remove Interior Assembly. • Slightly loosen the Mounting Plate screws. • Lock and unlock using the Key. • Reattach Control Wire and Interior Assembly.
Keypad not working	• Wait 60 seconds, keypad may be locked out due to incorrect code. • Replace with 4 high quality alkaline batteries.
Keypad beeps and LED flashes	• Replace with 4 high quality alkaline batteries.

CONSUMER ASSISTANCE

EMAIL: LHLPCustomerService@LHL.Pinc.com WEBSITE: www.honeywellsafes.com
ADDRESS: Consumer Assistance Dept. LH Licensed Products, Inc. 860 East Sandhill Avenue Carson, CA 90746 USA
TELEPHONE: US/Canada 1-800-860-1677 Ext. 1801 (Toll Free)
Mexico 01-800-288-2872 After English voice recording stops you must then enter 800-860-1677 to complete your call. (Toll Free)
Australia 0011-800-5325-7000 (Toll Free)
Germany/New Zealand 00-800-5325-7000 (Toll Free)
Other Countries XXX-310-323-5722 (Toll Charges Apply)
XXX- Dial U.S. Country Code first
CALL CENTER HOURS: US/Canada 8am - 5pm (Pacific**) Mon - Fri (Subject to change)
CALL BACK HOURS: Other Countries 8am - 5pm (Pacific**) Mon - Fri (Subject to change)
Pacific** - Local time in Los Angeles, CA, USA
* Insert correct Country Code
** Local Time based on Los Angeles California USA
INTERNATIONAL CALL BACK HOURS:

If you need to speak with a consumer assistant and cannot contact us during the Call Center hours above, please send an email or leave a telephone message, including your Name, Telephone Number and the best time for us to contact you during the Call Back hours above and we will make our every effort to contact you and help answer any of your questions or concerns.

Limited Lifetime Mechanical and Finish Warranty / 1 Year Limited Electronics Warranty

This product comes with a limited lifetime mechanical and finish warranty and a one year limited electronics warranty to the original residential consumer against defects in material and workmanship under normal use as long as the original residential purchaser occupies the residential premises upon which the product was originally installed.

ORIGINAL RESIDENTIAL CONSUMER

This warranty is not transferable, and applies to the original purchaser only, as long as the original purchaser occupies the residential premises upon which the product(s) was originally installed. Proof of purchase (original sales receipt) and ownership must accompany all warranty claims. All non-homeowner purchasers (including purchasers for industrial, commercial and business use) are not covered under the terms of this warranty.

WHAT IS NOT COVERED

This warranty is null and void if the product was used for purposes for which it was not designed. This warranty DOES NOT COVER normal wear and tear of parts or damage resulting from any of the following: negligent use, misuse or abuse of the product, or use contrary to or in violation of written instructions provided by LH Licensed Products, Inc. Further, this warranty does not cover Acts of God, such as fire, flood, hurricanes and tornadoes. This warranty DOES NOT COVER scratches, abrasions, deterioration due to the use of paints, solvents or use of cleaners containing abrasives, alcohol or other solvents, whether performed by a contractor, service company, or yourself. This warranty DOES NOT COVER product(s) used in commercial applications, used in common area applications, disassembly, repair or alteration by anyone other than LH Licensed Products, Inc., improper installation or exposure to extremes of heat or humidity. This warranty DOES NOT COVER any losses, injuries to persons or loss of property, general damages or costs, and shipping and freight expenses required to return product(s) to LH Licensed Products, Inc. LH Licensed Products, Inc. shall not be liable for any indirect, incidental or consequential damages of any nature relating to this lock. LH Licensed Products, Inc. is also not responsible for costs associated with removing or reinstalling the product.

ADDITIONAL TERMS

LH Licensed Products, Inc. does not authorize any person to create for it any obligation or liability in connection with the Product. LH Licensed Products, Inc.'s maximum liability here under is limited to the original purchase price of the Product. No action arising out of any claimed breach of this warranty by LH Licensed Products, Inc. may be brought by the original residential purchaser more than one (1) year after the cause of action has arisen.

AUSTRALIAN CONSUMER LAW

Our goods come with guarantees that cannot be excluded under the Australian Consumer Law. You are entitled to a replacement or refund for a major failure and for compensation for any other reasonably foreseeable loss or damage. You are also entitled to have the goods repaired or replaced if the goods fail to be of acceptable quality and the failure does not amount to a major failure.

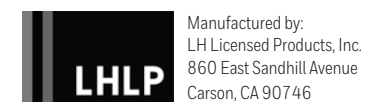

The Honeywell Trademark is used under license from Honeywell International Inc. Honeywell International Inc. makes no representations or warranties with respect to this product.
www.honeywellsafes.com

M8712009 8712109 8712309 8712309L 8712409 8712509 TFE V2