

USER MANUAL

Livoltek All-in-One Inverter & Battery



Hyper - 5000

Copyright Declaration

The copyright of this manual belongs to SPAZIO POWER a division of Spazio Lighting (PTY) LTD. Any corporation or individual should not plagiarize, partially or fully copy and no reproduction or distribution of it in any form or by any means. All rights reserved.

Content

1.	About This Manual	4
1.1	Validity	4
1.2	Target Group	4
1.3	Symbol Used	4
1.4	Storage of the manual	4
2.	Safety Precautions	5
2.1	Personnel Requirements	5
2.2	Inverter Safety	5
2.3	Battery Safety	6
2.4	Installation Safety	7
2.5	Electrical Safety	7
2.6	Maintenance and Replacement	8
3.	Product Introduction	9
3.1	Function Description	9
3.2	Appearance	10
3.3	System Diagram	12
3.4	Work Modes	13
4.	Unpacking and Storage	17
4.1	Packing List	17
4.2	Identify the Inverter	19
5.	Mechanical Installation	22
5.1	Installation Requirements	22
5.2	Installation Instruction	24
6.	Electrical Connection	31
6.1	Wiring Diagram	32
6.2	Additional Grounding Connection	34
6.3	Grid Cable Connection	35
6.4	Critical Loads Connection (EPS function)	37

6.5 PV Cable Connection	39	
6.6 Battery Connection	41	
6.7 WIFI / 4G Connection (Optional)		45
6.8 DRM Connection	46	
6.9 Multi COM Terminal Connection		47
6.10 Installation Verification	53	
7. System Operation	54	
7.1 LEDs Display	54	
7.2 System Commissioning	56	
7.3 System Decommissioning	57	
8. Settings on the APP	58	
8.1 User Interface Introduction	58	
8.2 Download and Install	59	
9. Troubleshooting and Maintenance	60	
9.1 Troubleshooting	60	
9.2 Maintenance	62	
9.3 Removing the Inverter	63	
9.4 Disposal of the Inverter	63	
10. Technical Data	64	
11. Disclaimer	66	

1. About This Manual

1.1 Validity

Thank you for choosing our low-voltage hybrid inverter. This manual is valid for the following models:



Hyper 5000

1.2 Target Group

This manual is intended for qualified persons and inverter owners. All activities described in the document may only be carried out by specially trained personnel in compliance with standards, wiring rules and the requirements of local grid authorities or companies. Moreover, they must also understand basic safety precautions and with the knowledge of how to deal with the dangers and risks associated with installing, repairing and using electrical devices and batteries.

1.3 Symbol Used

Safety instructions will be highlighted with the following symbols.

Symbol	Description
 DANGER	Indicates a hazard with a high level of risk that, if not avoided, will result in death or serious injury.
 WARNING	Indicates a hazard with a medium level of risk that, if not avoided, could result in death or serious injury.
 CAUTION	Indicates a hazard with a low level of risk that, if not avoided, could result in minor or moderate injury.
NOTICE	Indicates a situation that, if not avoided, could result in equipment or property damage.

1.4 Storage of the manual

Read the manual and other related documents before performing any operation on the inverter. Documents must be stored carefully and be available at all times.

Notes: *This user manual is subject to change (specific please in kind prevail) without prior notice. Please check www.livoltex.com for more information.*

2. Safety Precautions

The inverter has been designed and tested strictly in accordance with international safety regulations. As with all electrical or electronic devices, there are residual risks despite careful construction. Read all safety instructions carefully prior to any work and observe them at all times when working on or with the inverter to prevent personal injury and property damage and to ensure long-term operation of the inverter.

Ensure that the equipment is used in environments that meet its design specifications. Otherwise, the equipment may become faulty, and the resulting equipment malfunction, component damage, personal injuries, or property damage are not covered under the warranty.

Follow local laws and regulations when installing, operating, or maintaining the equipment. The safety instructions in this document are only supplements to local laws and regulations.

2.1 Personnel Requirements

The inverter must be installed, electrically connected, operated and maintained by specially trained and qualified electrician.

The qualified persons must have the following skills:

- Training in how to deal with the dangers and risks associated with installing, repairing and using electrical devices, batteries and installations
- Knowledge of the installation and commissioning of electrical system, as well as working process of PV power generation system.
- Knowledge of and compliance with this document and all safety information.
- Knowledge of all applicable laws, standards and directives.
- Knowledge of how batteries work and with all safety information.

2.2 Inverter Safety



DANGER

Danger to life due to electric shock when live components are touched on opening the product

- High voltages are present in the live parts and cables inside the product during operation. Touching live parts and cables results in death or lethal injuries due to electric shock.
- Do not open the inverter cover or change any components without manufacturer's authorization. Otherwise, the warranty for the inverter will be invalid.

 **WARNING**

Danger to life due to fire or explosion

In rare cases, an explosive gas mixture can be generated inside the product under fault conditions. In this state, switching operations can cause a fire inside the product or explosion. Death or lethal injuries due to hot or flying debris can result.

- In the event of a fault, do not perform any direct actions on the product.
- Ensure that unauthorized persons have no access to the product.
- Only perform work on the product (e.g., troubleshooting, repair work) when wearing personal protective equipment for handling of hazardous substances (e.g., safety gloves, eye and face protection, respiratory protection).
- Wait at least 10 minutes for the internal capacitors to discharge after the battery is powered off.
- Ensure that there is no voltage or current before installing or disconnecting any connectors.
- All safety instructions, warning labels, and nameplate on the inverter should not be removed or covered.

 **CAUTION**

Risk of burns due to hot components! Avoid any unnecessary touching!

- Do not touch any hot parts (such as the heat sink) during operation. Only the DC switch can safely be touched at any time.

2.3 Battery Safety

 **DANGER**

Danger to life from electric shock due to live DC cables at the battery.

The DC cables connected to a battery may be live. Touching the DC conductors or the live components leads to lethal electric shocks.

- Do not touch non-insulated cable ends.
- Do not touch any live components.
- Have the inverter and the battery mounted, installed and commissioned only by qualified persons with the appropriate skills.
- Observe all safety information of the battery manufacturer.
- Prior to performing any work on the inverter or the battery, disconnect the inverter from all voltage sources as described in this document.
- If an error occurs, have it rectified by qualified persons only.

 **WARNING**

Risk of burns due to electric arcs

- Short-circuit currents in the battery can cause heat build-up and electric arcs.
- Disconnect the battery from all voltages sources prior to performing any work on the battery.
- Observe safety information of the battery manufacturer when working on the battery or inverter.

NOTICE

- Improper settings or maintenance can permanently damage the battery.
- Incorrect inverter parameters will lead to the premature aging of battery.

2.4 Installation Safety

NOTICE

As soon as receiving the inverter please check if it is damaged during its transportation. If yes, please contact your dealer immediately.

- Adequate ventilation must be provided for inverter installation location.
- Mount the inverter in vertical direction, and ensure that no objects block the heat dissipation.
- The safety instructions in this manual cannot cover all the precautions that should be followed. Perform operations considering actual onsite conditions.
- LIVOLTEK shall not be held liable for any damage caused by violation of the safety instructions in this manual.

2.5Electrical Safety

 **DANGER**

- Before installing the inverter check all electrical ports to ensure no damage and no short circuit, otherwise personal casualty and or fire will occur.
- Input terminals of the PV inverter apply only to input terminals of PV String do not connect any other DC source to the input terminals.
- Before connecting PV Arrays ensure that its voltage is within the safe range.
- Before touching the DC cables, operator must use a measuring device to ensure that the cable is voltage-free.
- The operator must follow all warnings on the PV strings and in its manual.

- All electrical connections must be in accordance with local and national standards. Only with the permission of the local utility grid company, the inverter can be connected to the utility grid.

2.6 Maintenance and Replacement



DANGER

- High voltage generated by the equipment during operation may cause an electric shock, which could result in death, serious injury, or serious property damage. Prior to maintenance, power off the equipment and strictly comply with the safety precautions in this document and relevant documents.
- Maintain the equipment with sufficient knowledge of this document and using proper tools and testing equipment.
- Before maintaining the equipment, power it off and follow the instructions on the delayed discharge label to ensure that the equipment is powered off.
- Turn off the AC and DC switches of the inverter when maintaining the electric equipment or power distribution equipment connected the inverter.
- For personal safety maintenance personnel must wear appropriate personal protective equipment (like insulation gloves and protective shoes) for the inverter maintenance.
- Place temporary warning signs or erect fences to prevent unauthorized access to the maintenance site.
- Follow the procedures of maintenance stipulated in the manual strictly.
- Check the relevant safety and performance of the inverter rectify any faults that may compromise the inverter security performance before restarting the inverter.
- To avoid any other unforeseeable risk, contact immediately your dealer, if there is any issue found during operation.
- The equipment can be powered on only after all faults are rectified. Failing to do so may escalate faults or damage the equipment.

3. Product Introduction

3.1 Function Description

- LIVOLTEK Hyper Series, also called hybrid inverters, are applicable to both on-grid and off-grid solar system with participation of PV array, battery, loads and grid system for energy management.
- The inverter converts the DC power from the PV array or the battery to the AC power. It also transmits the DC power from the PV array to the battery. With the bidirectional converter integrated inside, the inverter can charge or discharge the battery.
- Thanks to its integrated EPS (Emergency Power Supply) function, the hybrid inverter can utilize power from PV panels & energy stored in the battery to supply power to critical load during a grid failure.
- In addition, to meet the increasing prevalence of EVs, this hybrid inverter allows you to use solar panels to charge your electric car. The inverter can communicate with the smart meter to measure your electricity usage from grid, and calculate the PV power as well as battery power to provide available power to EV charger, helping you find ways to save energy and money.

NOTICE

- The Hyper series must only be operated in connection with an intrinsically safe lithium-ion battery approved by Hangzhou LIVOLTEK Power Co., Ltd.
- The battery must comply with the locally applicable standards and directives and must be intrinsically safe.
- The communication interface of the used battery must be compatible with the product.
- The entire battery voltage range must be completely within the permissible input voltage range of the product.
- The maximum permissible DC input voltage of the product must not be exceeded.

3.2 Appearance

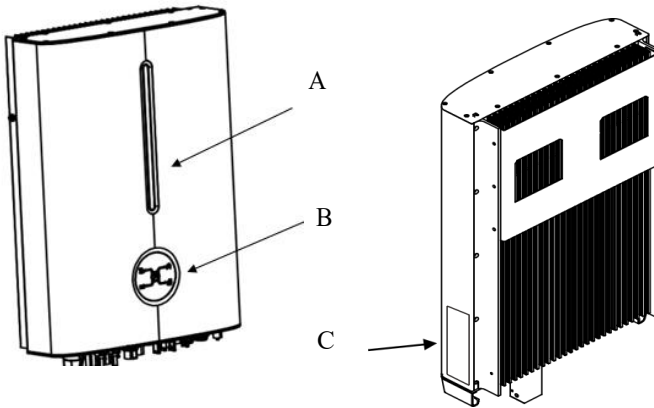

Figure 1. Appearance

Position	Designation
A	Battery SOC indicator: Indicates the SOC status of the connected lithium battery.
B	Inverter LED indicator: Displays the current operating status of the inverter
C	Nameplate Label: Clearly identify the product, including the SN, technical data, certifications, etc.

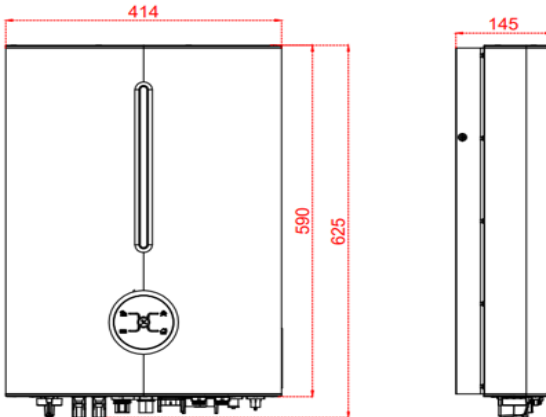

Figure 2. Dimension

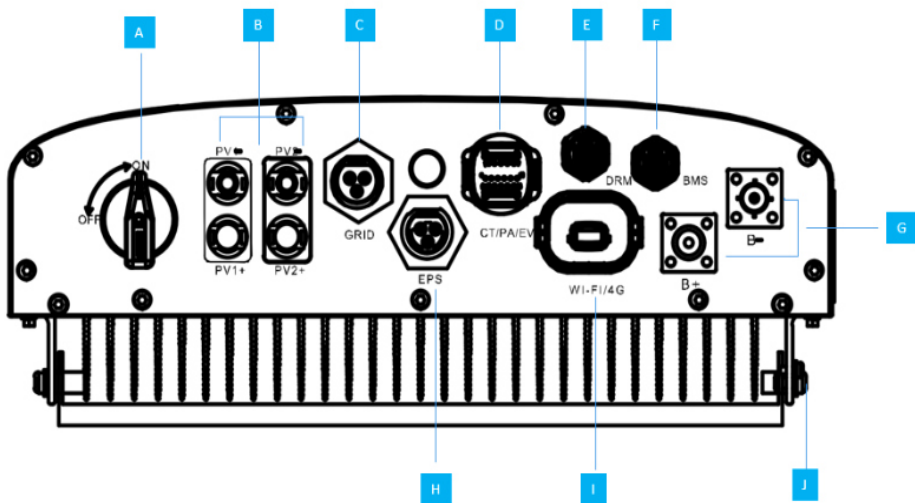
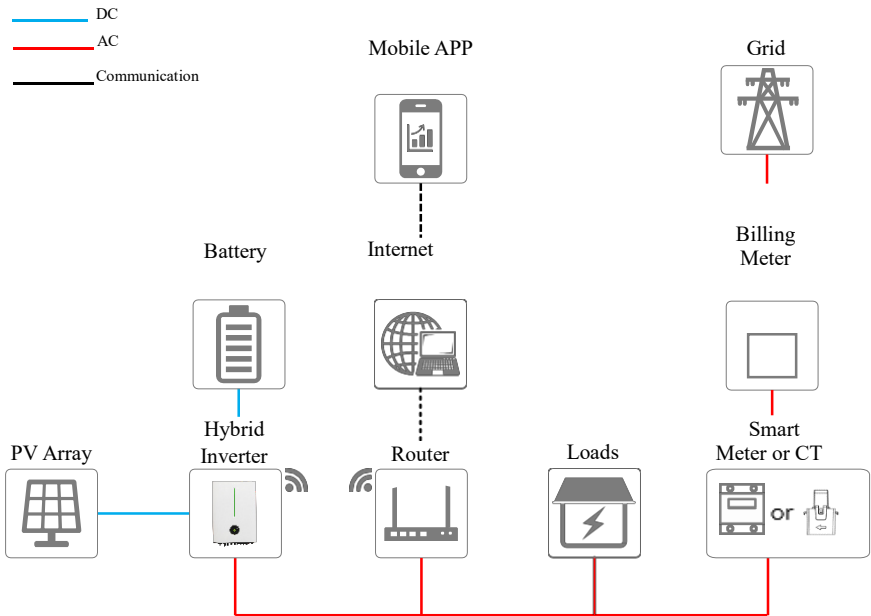

Figure 3. Terminals on the inverter

Position	Description
A	DC Switch (Optional)
B	PV Inputs(one or two pairs, depending on the model)
C	Grid output for connection to the utility grid
D	MULTI COM Port for CT/PA/EV connection
E	DRM Port
F	BMS Port
G	Battery Connectors
H	EPS Output for backup loads
I	Communication Port for Wi-Fi /4G (Optional) Stick
J	Additional Grounding terminal

3.3 System Diagram



3.4 Work Modes

The hybrid inverter offers four operating modes (Self-use, Self-define, backup and off-grid) that can be configured via LIVOLTEK APP for you to determine which mode will be best for you.

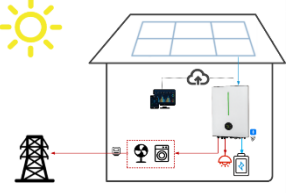
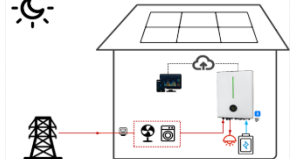
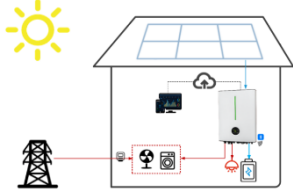
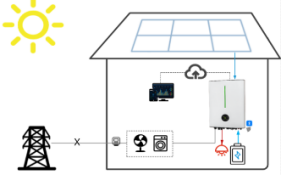
Modes	Description
<p>Self-Use(Default)</p> 	<ul style="list-style-type: none"> •The energy produced by the PV system will go for loads consumption first, then charge battery, rest power exports to grid, battery will charge or discharge automatically based on the system condition. •Suitable for areas with the low import rate and high electricity price.
<p>Self-Define</p> 	<ul style="list-style-type: none"> •Charge/discharge time can be set as customer need. During the non-set time period, it will work in self-use mode. •Suitable for areas with time of use tariffs which means prices vary between peak and valley.
<p>Backup Mode</p> 	<ul style="list-style-type: none"> •When the grid is functional the battery is kept full capacity and will only be allowed to discharge when grid is unavailable •Suitable for areas with unstable grid to prolong the autonomy in the event of grid outage. Or reducing the frequency charging & discharging of battery to extend battery life.
<p>Off-grid</p> 	<ul style="list-style-type: none"> •The critical loads will be powered by PV production and Battery (Battery is necessary in this mode.) •Suitable for non-grid areas, and the inverter will automatic activation this mode in the event of grid failure.

3.4.1 On-Grid Self-Use Mode

The purpose of this mode is to maximize the solar energy usage and lower the power import from the grid.

➤ **When PV, grid, battery is available:**

- If PV production \geq Load consumption, PV production will go for loads consumption first, the excess energy will be stored in the battery, and then exported to grid if needed and configured that way *1.
- If PV production $<$ Load consumption, the battery will discharge only for loads consumption until reaches its power limit *2.
- If PV production + Battery $<$ consumption, the system will import power from the grid to power the loads, not for battery charge.
- The power switch between PV production, battery and grid is automatic and seamless.

➤ **When PV, grid is available (without battery):**

- If PV production \geq Load consumption, PV production will go for loads consumption first, then the excess will export to the grid.
- If PV production $<$ consumption, the system will import power from the grid to power the loads, not for battery charge *3.

➤ **When PV, battery is available (Grid is disconnected):**

- In the event of a grid failure or there is no mains, the hybrid inverter automatically switches to Off-grid operation mode.

The off-grid mode ensures that the system forms a battery-backup grid that utilize power from PV production and battery to supply power to critical loads.

- The switch time in the system is less than 20ms from one mode to another.

Notes:

*1: The inverter offers an export limitation function for you to decide whether you have a grid limitation, and specify its value via LIVOLTEK APP. The export power should not be more than the limit value set in commissioning

*2: The battery will stop to discharge when the value is lower than the discharge cut-off SOC of lithium batteries or discharge cut-off voltage of lead-acid batteries, which is available for setting. And the battery power supply can be restored when the battery is

charged to the “set value +10%” by solar.

*3: The battery will be charged only when PV production is sufficient.

3.4.2 On-Grid Self-Define Mode

On-Grid Self-Define Mode also called Time-of-use Mode. When operating in this mode, the charging and discharging time can be set flexibly according to your wishes, and it also allows to choose whether charge from the grid or not*1. This mode is ideal for those who want to store the power into the battery when the electricity price is in the off-peak rate and use the power in peak rate time or save the energy for blackout.

➤ **When PV, grid, battery is available:**

- During charge time, solar energy and grid will charge battery***2** as first priority at the same time, the excess solar energy will go for loads consumption and exported to grid if needed and configured that way.
- During discharge time, PV production will go for loads consumption first, battery and excess solar energy will export to the grid***3** at the same time.
- During the period of no charge or discharge, the inverter will automatically work in the Self-Use mode.

➤ **When grid, battery is available (PV is disconnected):**

- During charge time, grid will charge battery and supply power to the connected loads at the same time.
- During discharge time, battery will discharge to EPS loads first, then the excess energy will export to the grid.

Notes:

*1: Firmware update may be required to support this mode.

*2: You can choose whether to import from the grid to charge the battery via the LIVOLTEK APP.

*3: You can choose whether to export to the grid from the battery via the LIVOLTEK APP.

3.4.3 On-Grid Backup Mode

- When operating in this mode, solar energy and grid will fully charge battery as first

priority at the same time.

- The loads will be supplied by the surplus solar production supplemented, if necessary by the public electricity grid. The battery will be used only when the grid failure.

NOTICE
<ul style="list-style-type: none">•If set zero feed-in, the system will not export power to grid when work on the mode of self-use, self-define or backup. But a small amount of energy will still inevitably be fed into grid due to unpredictable PV energy change and load fluctuations.

3.4.4 Off-Grid Mode











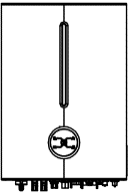
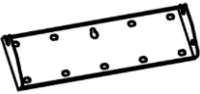

When operating in this mode, Photovoltaic and battery constitute a pure off-grid system, the critical loads (EPS Loads) will be powered by PV production and if the PV production is insufficient, battery will discharge to power the loads at the same time. (Battery is necessary in this mode.)

NOTICE
<ul style="list-style-type: none">•When battery is discharged to the DischargeEndSOC@EPS value, the inverter will stop working and wait for the grid to recover or until there is sufficient power from PV panels to charge the battery.•If grid failure is a common occurrence in your area, it is recommended to adjust the DischargeEndSOC@Grid higher to ensure there is more battery power available.

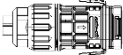
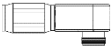
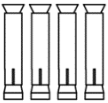
4. Unpacking and Storage

The inverter is thoroughly tested and strictly inspected before delivery. Damage may still occur during shipping. Please check the outer packing for damage and the inner contents for any visible damage. Contact your distributor immediately in case of any damaged or missing components.

4.1 Packing List

 <p>A</p>	 <p>B</p>	 <p>C</p>	 <p>D</p>
 <p>E</p>	 <p>F</p>	 <p>G</p>	 <p>H</p>
 <p>I</p>	 <p>J</p>	 <p>K</p>	 <p>L</p>
 <p>M</p>	 <p>N</p>	 <p>O</p>	 <p>P</p>

Position	QTY	Designation
A	1	Inverter
B	1	Inverter Bracket (Split Application)
C	1	EPS Plug for backup loads (critical Loads)
D	1	AC Plug for Grid
E	4	Positive & Negative PV Plugs (Two pairs)
F	1	Wi-Fi & Bluetooth integrated Stick
G	1	CT(Current Transformer) & CT cable
H	1	16pin COM connector for CT/Parallel/EV charger
I	2	Positive & Negative BAT Plugs (one pairs)
J	4	Expansion bolts for Wall-mounting Bracket(Split Application)
K	1	Screws for Fixing Mounting Bracket
L	1	PE terminal
M	1	Water-proof RJ45 Connector for BMS
N	1	Water-proof RJ45 Connector for DRM port
O	1	Quality Certificate
P	2	Documents(User Manual & Quick Guide)

Notes: *If anything is missing, please contact your local distributor.*

4.2 Identify the Inverter

4.2.1 Nameplate

After moving the hybrid inverter from package, identify it by reading its nameplate labeled on the side of the inverter. The nameplate contains important product information: the model information, technical specifications and compliance symbols. Take Hyper 5000 as an example.

Co

Logo, product model,

Max. PV Voltage	900V d.c.
MPPT Voltage Range	125-590V d.c.
Max. PV Current	14 /14A d.c.
PV Isc	17.5/17.5A d.c.
PV Inverter Topology	Non-isolated
Rated AC Voltage	230V a.c.
Rated AC Frequency	50/60Hz
Rated AC Power	5000VA
Max. Output Current	21.7A a.c.
Power Factor Range	-0.9~+0.9
Battery Type	LiFePO4
Rated Battery Voltage	48V d.c.
Battery Voltage Range	40-60V d.c.
Max. Charge Current	500A d.c.
Max. Discharge Current	500A d.c.
Galvanic Isolation for Bat.	Yes
AC Overvoltage-Category	III
DC Overvoltage-Category	II
IP Protection	IP65
Protective Class	Class I
Grid Regulations:	

Key technical data

Certification of inverter

Serial Number









SN (serial number)

Company name, website and country of origin

Hangzhou Livoltek Power Co., Ltd.
 Add: 1418-35, Moganashan Road,
 Hangzhou City, China
 web: www.livoltek.com
 MADE IN CHINA

Notes: The image shown here is for reference only. The actual product received may differ.

4.2.2 Compliance and Safety Symbols

Symbol	Explanation
	CE marking The product complies with the requirements of the applicable EU directives.
	UKCA marking The inverter complies with the requirements of the applicable UKCA guidelines.
	UKNI marking The inverter complies with the requirements of the applicable UKNI guidelines.
	Caution! Beware of a danger zone! Failure to observe any warnings contained in this manual may result in injury.
	Danger! Beware of hot surface! The inverter can become hot during operation.
	Danger! Beware of high voltage and electric shock! Beware of electrical voltage, the product operates at high voltages.
	Observe the documentation. Observe all documentation supplied with the product.
	WEEE designation. Do not dispose of the product together with the household waste but in accordance with the disposal regulations for electronic waste applicable at the installation site.
	Danger to life due to high voltage and electric shock! There are residual voltages in the inverter after powering off, you should wait at least 5mins after disconnecting the inverter from the utility grid and from the PV panel before touching any inner live parts.

4.3 Storage of Inverter

The following requirements should be met if the inverter will not be deployed immediately:

- Do not unpack the inverter (put desiccant in the original box if the inverter is unpacked).
- Store the inverter at a temperature range of -30°C to $+70^{\circ}\text{C}$, and with the relative humidity of 0% to 100% (no condensing).
- In case of stacking storage, the number of stacking layers should never exceed the limit marked on the outer side of the packing case.
- The inverter should be stored in a clean and dry place and be protected from dust and water vapor corrosion.
- Do not position the inverter at a front or excessive back or side tilt, or upside down.
- Conduct periodic inspection during storage. Replace the packing materials immediately if any rodent bites are found.
- Ensure that qualified personnel inspect and test the inverter before use if it has been stored for a long time.

5. Mechanical Installation

5.1 Installation Requirements

NOTICE
<ul style="list-style-type: none">• Make sure there is no electrical connection before installation.• In order to avoid electric shock or other injury, make sure that holes will not be drilled over any electricity or plumbing installations.• Always follow the instructions when moving or positioning the inverter.• Improper operation may cause injuries or serious wounds. In the case of poor ventilation, the system performance may compromise.

5.1.1 Location Requirements

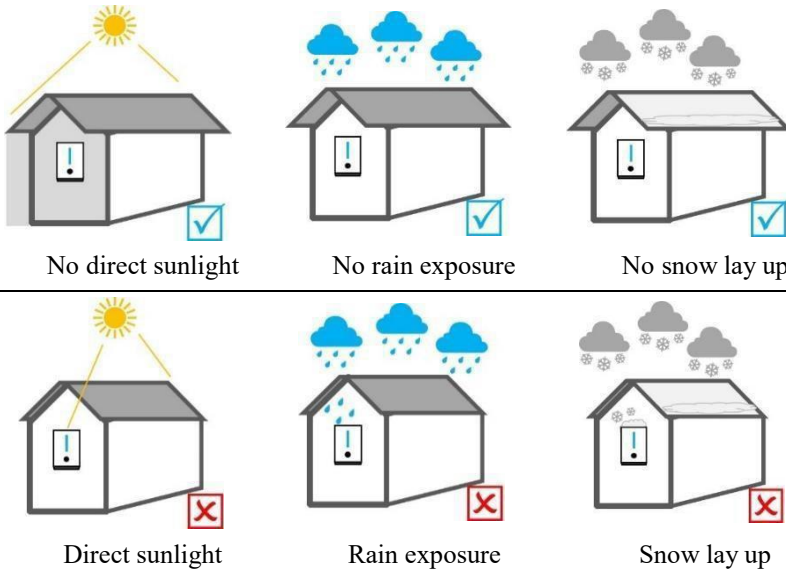

Select an optimal mounting location for safe operation, long service life and expected performance. Please AVOIDE direct sunlight, rain exposure, snow laying up during installation and operation. And DO NOT install the inverter in a place where personnel are likely to come into contact with its enclosure and heat sinks because these parts are extremely hot during operation.

5.1.2 Environment Requirements

The inverter must be installed in a ventilated environment to ensure good heat dissipation. Make sure the installation meets the following conditions:

- Not in areas where highly flammable materials are stored.
- Not in potential explosive areas.
- Not in the cool air directly.
- Not near the television antenna or antenna cable.
- Not higher than altitude of about 2000m above sea level.
- Not in environment of precipitation or humidity ($> 95\%$).
- The ambient temperature in the range of -20°C to $+60^{\circ}\text{C}$.
- The slope of the wall should be within $\pm 5^{\circ}$.
- The wall hanging the inverter should meet conditions below:
- The wall must be solid enough to bear the weight of the inverter.
- Do not install the inverter on a wall made of gypsum boards or similar materials with weak sound insulation to avoid noise disturbance in a residential area.

5.1.3 Angle and Space Requirements

NOTICE

- Never install the inverter horizontally, or with a forward tilt or with a backward tilt or even with upside down. The horizontal installation can result in damage to the inverter.
- Install the inverter upright or at a maximum back tilt of 15 degrees to facilitate heat dissipation.

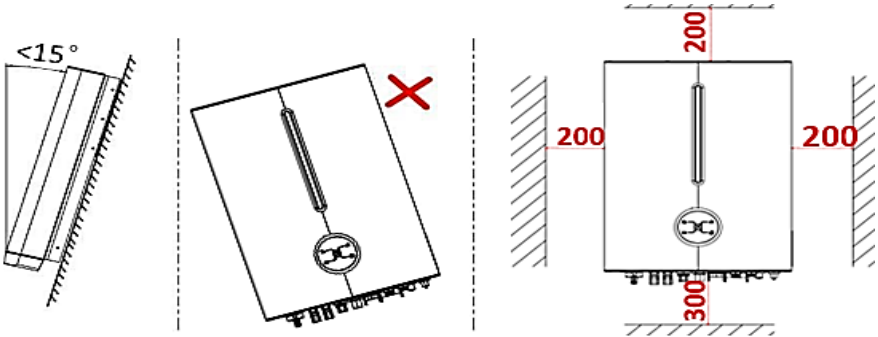

5.2 Installation Instruction

➤ Two types of Applications:

- There are two ways for hybrid inverter to be installed with battery. One called "Split Application" and the other called "All-in-one Application".
- For Split Application, the inverter can be matched with low voltage lithium battery from LIVOLTEK or Pylon or Lead acid battery.
- For All-in-one Application, the inverter must be matched with LIVOLTEK lithium battery, and also need purchasing a Middle Cover Kit which can help hiding the wires to make the whole system tidy and safe.
- For All-in-one Application, there are three units (inverter, battery and middle cover kit) packaged separately. Please check and contact your distributor immediately in case of any damaged or missing components.

➤ Installation Tools

Installation tools recommended but not limited to the following ones. If necessary, use other auxiliary tools on site.

 <p>Bit Φ10 Hammer drill</p>	 <p>Rubber hammer</p>	 <p>Tape ruler</p>	 <p>Spirit level\Marker</p>
 <p>Protective glasses</p>	 <p>Dustproof Cover</p>	 <p>OT terminals press clamp</p>	 <p>Wire stripper</p>
 <p>DC Voltage (Range \geq 1100V DC) Multimeter</p>	 <p>Euro terminal crimping tool</p>	 <p>Diagonal pliers</p>	 <p>Multifunction terminal crimping tool (RJ45)</p>

5.2.1 Installing the Inverter (Split Application)

Step1: Drill holes on the wall

- Take out the wall-mounting Bracket from the inverter package.
- Locate the appropriate drilling holes and mark it with a marker pen (Using a digital level to make sure the bracket is at a horizontal position before installation.)
- Drill holes with driller, make sure the holes are deep enough (at least 70mm) to support the inverter.

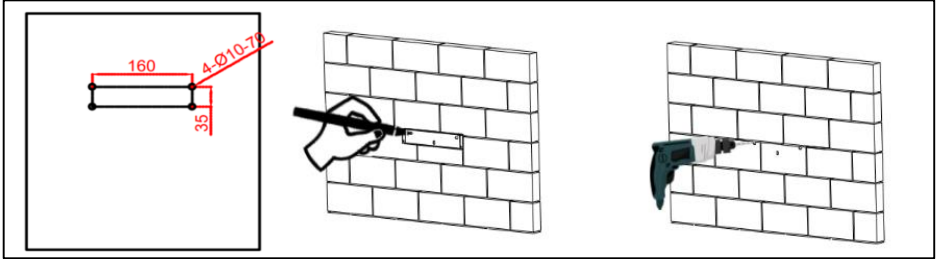

Step 2: Secure the mounting bracket on the wall

- Use expansion bolts or correct wall fixings to attach the mounting bracket to the wall tightly.

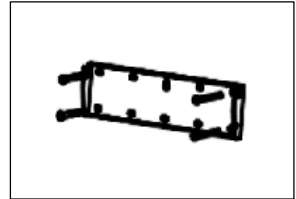

Step 3: Install the inverter on the mounting bracket

- Hang the inverter on the mounting bracket and lock the side with screw.

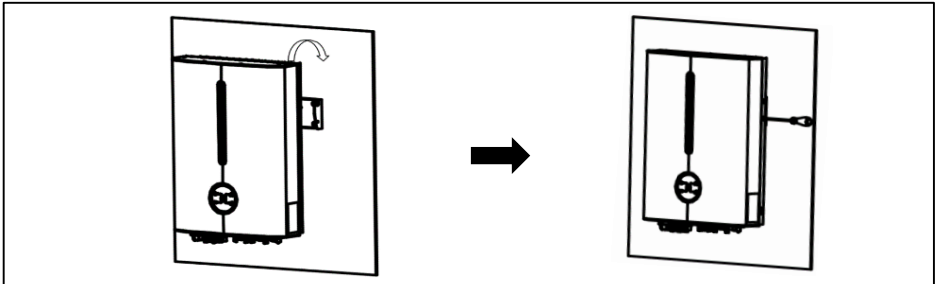

Step 4: Installation Self-check

- Ensure the inverter is well fixed;
- Ensure DC-switch is switched to OFF.

5.2.2 Installing the All-in-one System

Step1: Choose a location

- Choose an appropriate location capable of supporting the full weight (>90kg) and height of All-in-one system.
- Be sure to choose a flat wall.

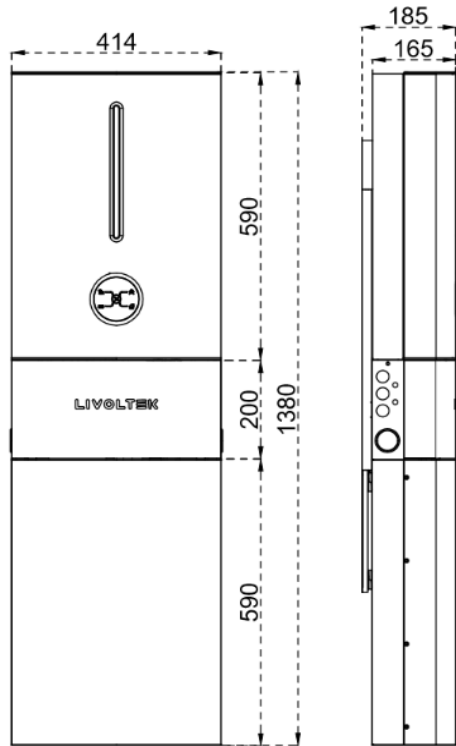

Step2: Take out the Brackets

- Open the packages of battery and middle cover kit respectively, then take out the wall-mounting brackets.

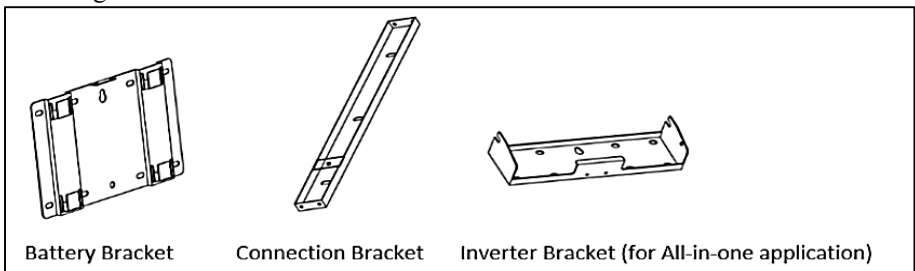

Notes: The inverter-bracket of for all-in-one application is not as same as the split one, please leave the split bracket and expansion bolts in the inverter's package when you want to install the all-in-one system).

Step 3: Assemble the All-in-one Mounting Bracket

- Assemble the All-in-one Mounting Bracket with 4 screws as shown below.

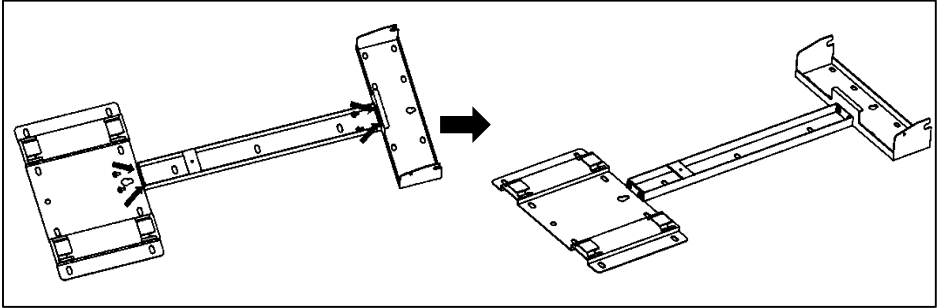

Step 4: Anchor All-in-one Mounting Bracket

- Determine the positions for drilling holes using the marking-off template, and then mark the positions with a marker.
- The height of the holes from the ground should be $\geq 450\text{mm}$
- Drill holes with driller (Drill bit: $\varphi 12$), make sure the holes are deep enough.

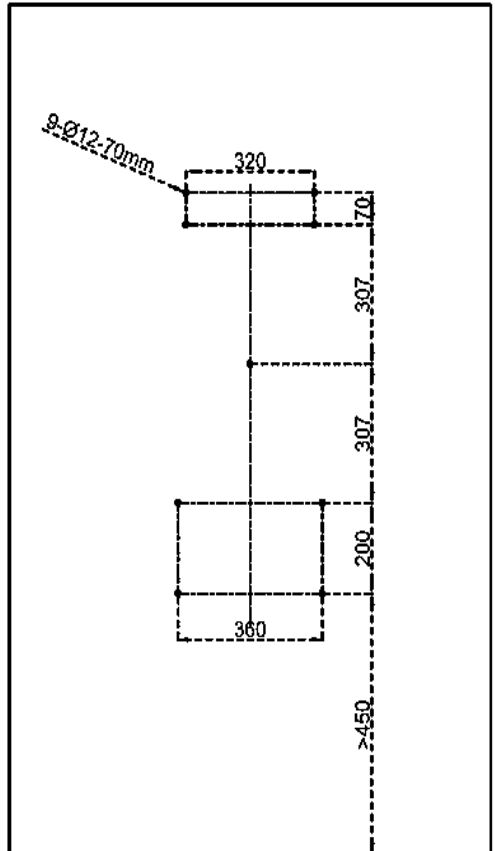

Step 5: Secure the All-in-one bracket on the wall

- Fix the All-in-one bracket to the wall with 9 expansion bolts.

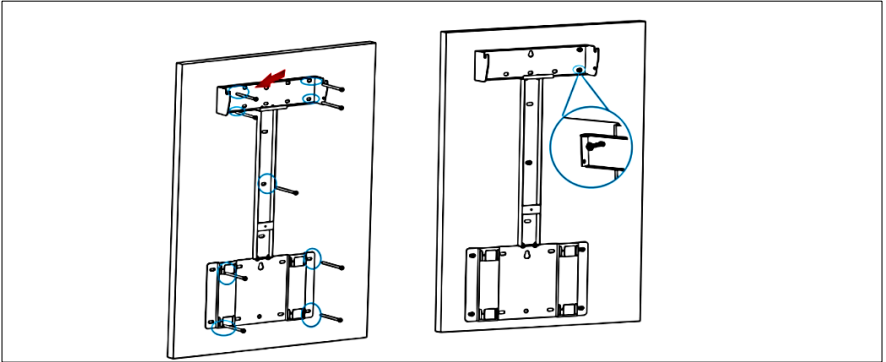

Step 6: Remove the upper cover of the Battery

- Pull out the front cover of the wiring area, then loosen the screws on the top cover to remove the upper cover of the battery.

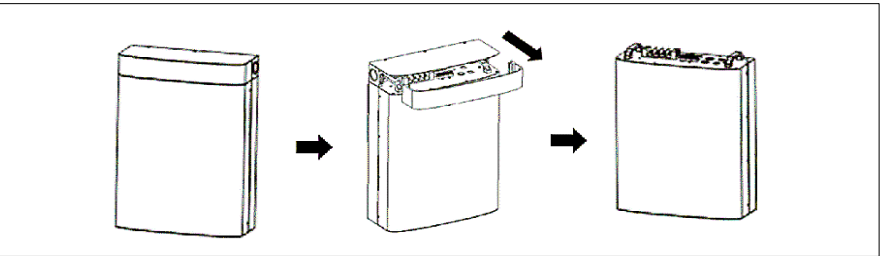

Step 7: Install the battery on the Bracket

- Lift and hang the battery to the battery-bracket.

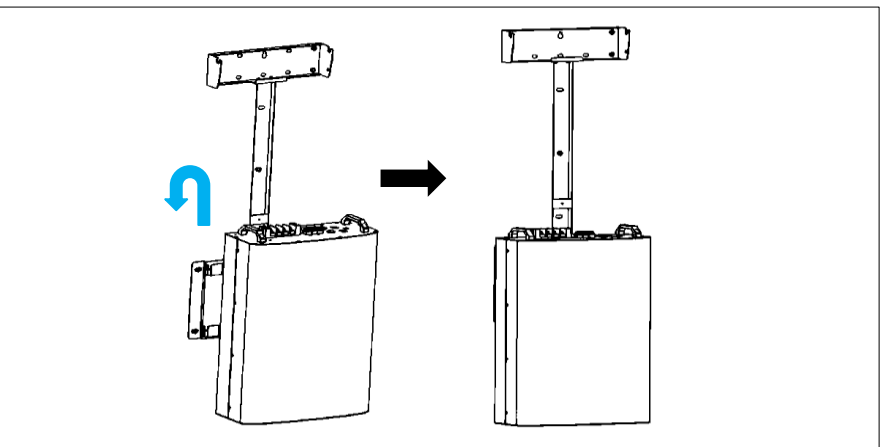

Step 8: Install the bottom of middle cover kit to the Bracket

- Install the bottom of middle cover kit to the all-in-one bracket and tighten the screws (M5*5).

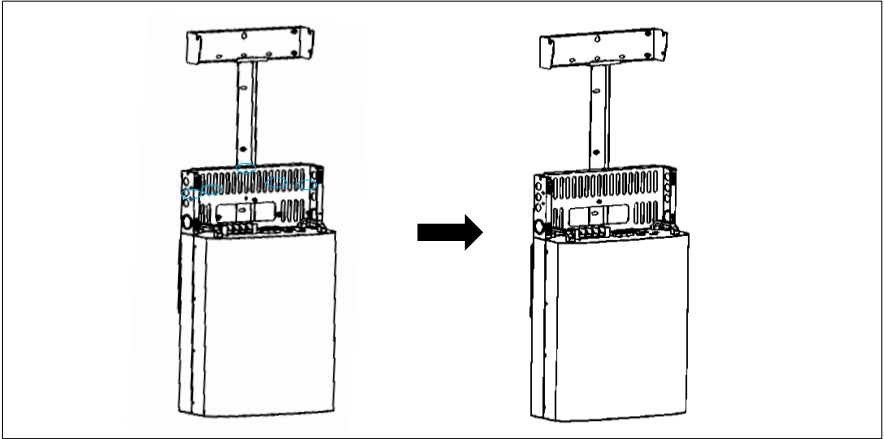

Step 9: Install the Inverter to the Bracket

- Lift and hang the Inverter to the bracket and secure with screw.
- Make sure that 2 mounting ears are perfectly engaged with the bracket.

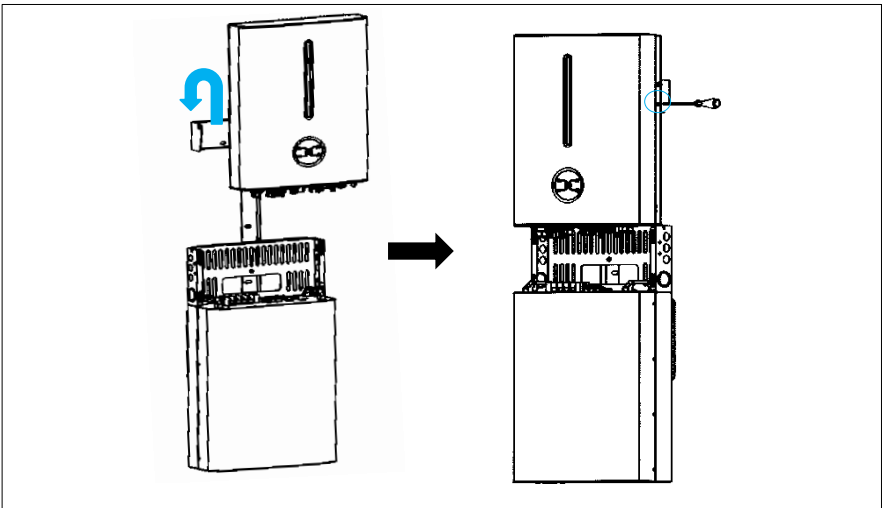

Step 10: Install the sideframes

- Install the left and right frames. The upper part of which should be hung to the corresponding holes of the inverter, and the lower part should be inserted into the middle

cover bottom. Then tighten them with M5 screws.

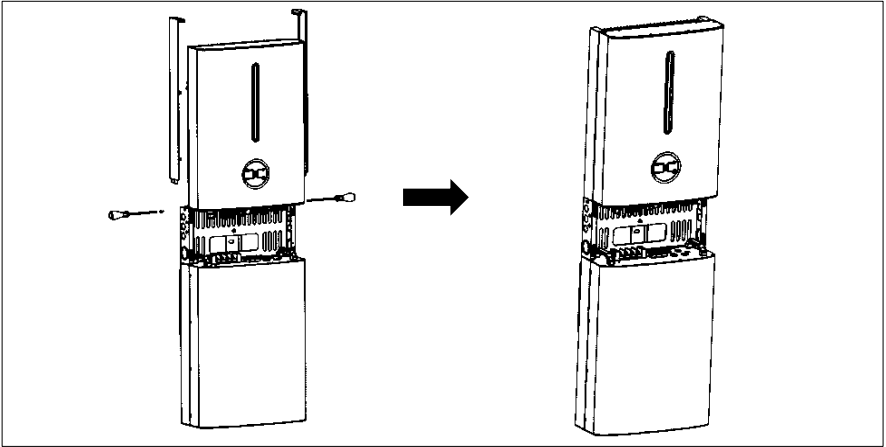

Step 11: Electrical Connection

Please refer to the Electrical Connection instructions in the next chapter.

Step 12: Install the Middle-cover

- Buckle the middle-cover to the all-in-one system after all electrical connection and settings are done
- DO NOT forget to grounding the Inverter and battery.

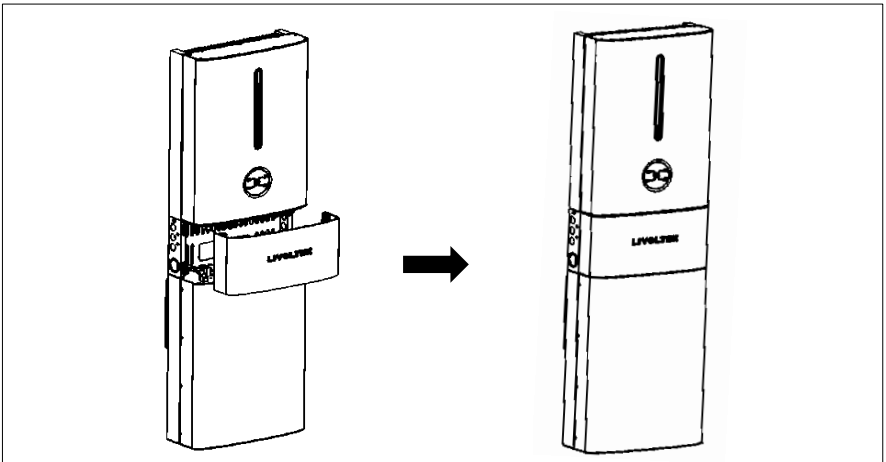

6. Electrical Connection

Prior to any electrical connections, keep in mind that the inverter has dual power supplies. It is mandatory for the qualified personnel to wear personal protective equipment (PPE) during the electrical work.



DANGER

Danger to life due to a high voltage inside the inverter!

- The PV string will generate lethal high voltage when exposed to sunlight. Before starting electrical connections, disconnect the DC and AC circuit breakers and prevent them from inadvertent reconnection.
- Ensure that all cables are voltage free before performing cable connection.



WARNING

- Any improper operations during cable connection can cause device damage or personal injury.
- Only qualified personnel can perform cable connection.
- All cables must be firmly attached, undamaged, properly insulated and adequately dimensioned.

NOTICE

- Comply with the safety instructions related to the PV strings and the regulations related to the utility grid.
- All electrical connections must be in accordance with local and national standards.
- Only with the permission of the utility grid, the inverter can be connected to the utility grid.

Notes:

The cable colors shown in the electrical connection diagrams provided in this chapter are for reference only. Select cables in accordance with local cable specifications (green and yellow cables are only used for PE).

6.2 Wiring Diagram for Australia and New Zealand

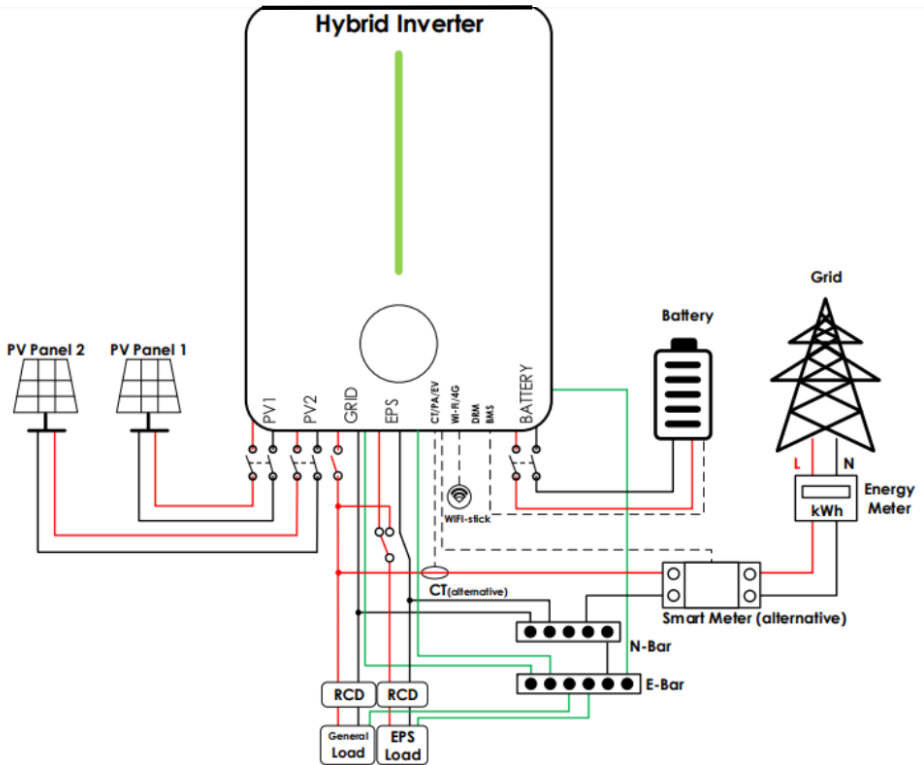

WARNING

- In Australia and New Zealand, electrical installation and maintenance shall be conducted by a licensed electrician and shall comply with Australia/New Zealand National Wiring Rules.
- Because the inverter does not maintain neutral integrity, an external neutral connection must be used in Australia and New Zealand. 30mA Type “A” RCD can be used where required by AS/NZ_3000, but cannot be used if there are backup loads on the inverter as per AS4777.
- For Australia and New Zealand, the neutral cable of Grid side and Backup side must be connected together according to the wiring rules AS/NZ_3000, otherwise backup function will not work.

6.2 Additional Grounding Connection

WARNING

- Ensure that the PE cable is securely connected. Otherwise, electric shocks may occur.
- Do not connect the neutral wire to the enclosure as a PE cable. Otherwise, electric shocks may occur.
- Good grounding for the inverter helps resist the impact of surge voltage and improve the EMI performance. Connect the PGND cable before connecting the AC power cables, DC power cables, and communication cables.

NOTICE

- The PE point at the AC output port is used only as a PE equipotential point, and cannot substitute for the PE point on the enclosure. Make sure the two terminals are both grounded reliably.
- It is recommended that silica gel or paint be used around the ground terminal after the PE cable is connected.

Suggested cable requirement for Ground wires

The additional grounding cable should be of the same cross section as the PE wire in the AC cable (prepared by customers).

Wiring Connection Procedure

Step1: Crimping an OT terminal.

- Prepare a one-core wire, and remove an appropriate length of the insulation layer from the PGND cable using a wire Stripper.
- Insert the exposed core wires into the crimping areas of the OT terminal and crimp them using hydraulic pliers.

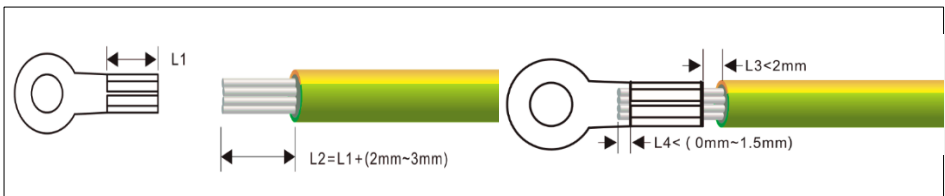

Step2: Connecting PE Cable

- Remove the screw on the grounding terminal on the side of the inverter and fasten

the cable with a screwdriver.

- Apply paint to the grounding terminal to ensure corrosion resistance.

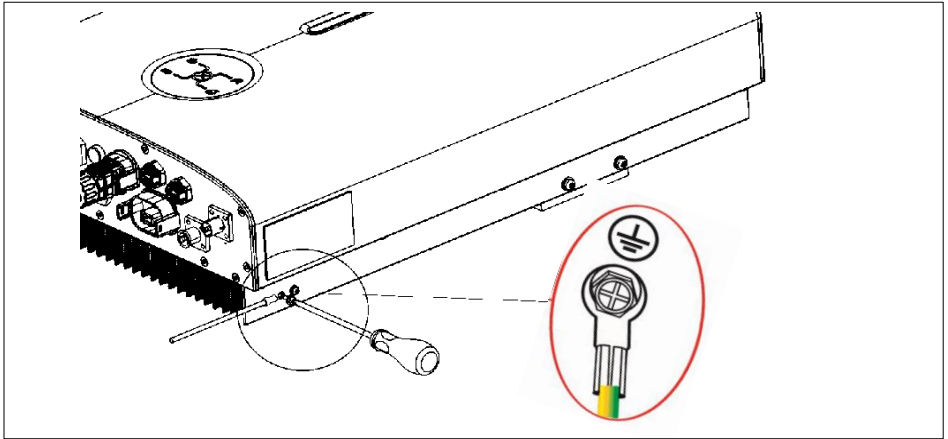

6.3 Grid Cable Connection

The hybrid inverter has two AC output terminals, one is grid output for connecting grid and the other is EPS (emergency power supply) output for connecting critical loads.

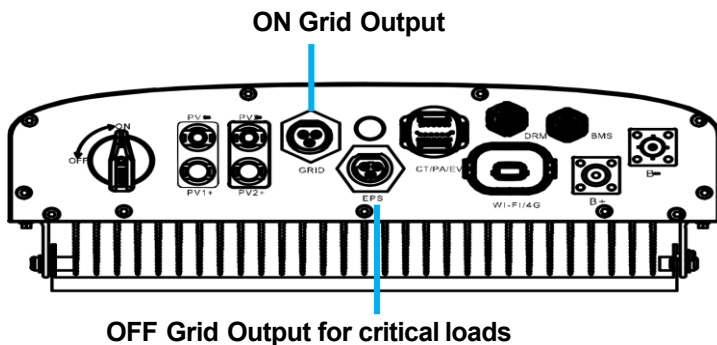

WARNING

- On grid terminal and off grid terminal **CAN NOT** directly connect together.
- Off Grid terminal (EPS output) **CAN NOT** connect to grid.
- When you want to use both on grid power and backup power, please connect both with Grid output and EPS output.
- When you want to use on grid only, please connect with Grid output and float EPS output.

Grid and EPS output terminals show as below:

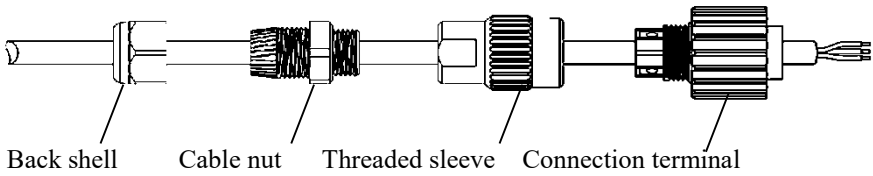

⚠ WARNING	
•	The grid voltage and frequency must be in the permissible range.
•	An external AC breaker must be installed on the AC side of each inverter to ensure that the inverter can be safely disconnected from grid when necessary.
•	In the systems with multiple inverters, protect each inverter with a separate circuit breaker.
•	Never connect a load between the inverter and the circuit breaker.

Suggested cable requirement for Grid wires

Model	Wire Size	Cable	Beaker
3~5KVA	12AWG	4-6mm ²	32A

Wiring Connection Procedure

Step1: Assembling the GRID Connector

- Uninstall the AC terminals.
- Remove an appropriate length of the jacket and insulation layer from the AC output cable using a wire stripper.
- Thread cables through back shell, cable nut, threaded sleeve in sequence, insert cables into connection terminal according to polarities indicates on it and tighten the screws.
- Make sure Live/Neutral/PE wire are correct, please follow the markings on the connector.
- Push sleeve on to connection terminal until both are locked tightly.

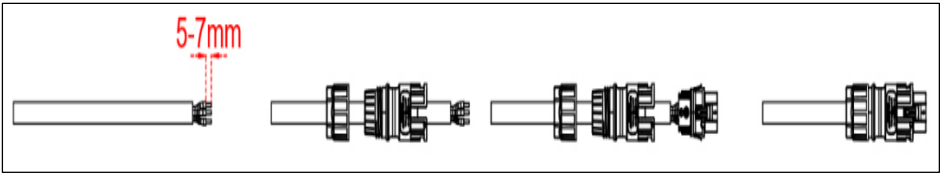

Step 2: Connecting AC Connector

- After AC wiring, route the AC connector into the AC terminal of the inverter and double check it.
- Connect “PE” conductor to the grounding electrode. Connect “L” and “N” conductors to the AC circuit breaker.
- Make sure all the wires are firmly installed via the right torque tool or dragging the cables slightly.

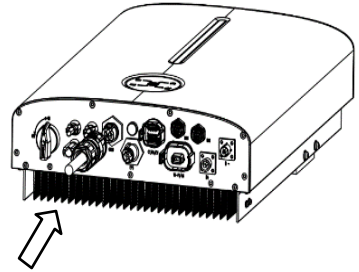

WARNING

High leakage current!

- Ensure all cables are voltage-free before electrical connection.
- Do not connect the AC circuit breaker until all inverter electrical connections are completed.

6.4 Critical Loads Connection (EPSfunction)

If you want to use the energy storage system to power the house (as a standalone system or during Grid failure), the EPS connector should be used and the EPS function should be enabled during setup. Otherwise you could leave the EPS port disconnected.

The EPS output port is only for critical loads connection.

WARNING

- The grid voltage and frequency must be in the permissible range.
- Risk of inverter damage due to incorrect cable connection. Do not connect the grid power wires to EPS port.
- An independent circuit breaker must be installed on the EPS side to cut off the inverter from EPS loads when necessary.
- Decide which household appliances should be included in the EPS circuit and carry out any required re-wiring.

6.4.1 Wiring Connection Procedure

Step 1: Assembling the EPS Connector(reference to Grid connector).

- Make sure Live/Neutral/PE wires are correct.
- Be sure follow the markings on the connector.

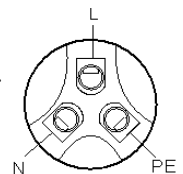

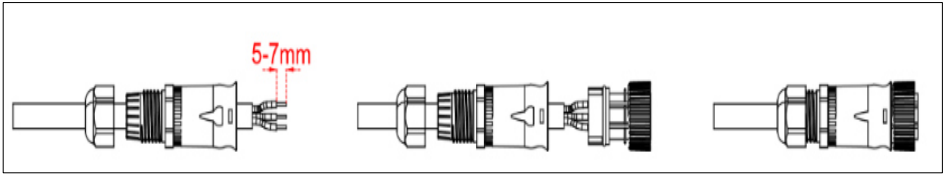

Step 2: Connecting EPS Connector

- Unscrew the cap on the EPS port.
- Insert the EPS cable into the EPS port on the inverter until there is a “Click” sound.

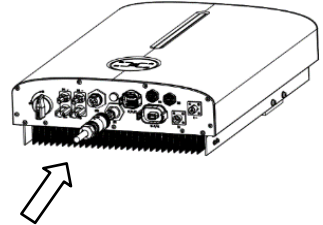

6.4.2 Declaration for EPS Loads

The purpose of the EPS Loads Function is to enable certain house circuits to remain on in the event of a power failure.

Make sure that the combined power required for all devices connected to this output does not exceed the power rating of the inverter.

⚠ CAUTION

The hybrid inverter can supply a continuous 5000VA output (max 5500VA for 10s) on EPS side. And the inverter has self-protection derating at high ambient temperature.

Accepted loads as below:

- Inductive Load: Max 1.5KVA for single inductive load, max 2.5KVA for total inductive load power.
- Capacitive load: Total capacitive load (like computer, switch power etc.) power $\leq 3.0\text{KVA}$
- Do not connect loads that are dependent on a stable energy supply for a reliable operation.
- Do not connect the loads that may cause very high start-up current surges, such as air-conditioner, high-power pump, and hair drier.
- Due to the condition of the battery itself, battery current might be limited by some factors, including but not limited to the temperature and weather.

NOTICE

- Appliances such as air conditioner are required at least 2~3 minutes to restart because it's required to have enough time to balance refrigerant gas inside of circuits. If a power shortage occurs and recovers in a short time, it will cause damage to your connected appliances.
- To prevent this kind of damage, please check manufacturer of air conditioner if it's equipped with time-delay function before installation. Otherwise, this inverter will trigger overload fault and cut off output to protect your appliance but sometimes it still causes internal damage to the air conditioner.

6.5 PV Cable Connection



DANGER

Danger of electric shock!

- The PV array will generate lethal high voltage once exposed to sunlight. Ensure all cables are voltage-free before performing electrical operations.
- Do not connect the AC circuit breaker before finishing electrical connection.



WARNING

- Make sure the PV arrays are well insulated to ground before connecting it to the inverter.
- Make sure the voltage, current and power ratings of the PV arrays are within the permissible range.
- Make sure polarity is correct. The inverter will not function properly if any PV polarity is reversed.
- The 3.68kW/5kW inverter is designed with 2 MPPT trackers, if the inputs of the PV panels are paralleled, please consult with your local distributor for technical support.
- To avoid any malfunction, do not connect any PV Arrays with possible current leakage to the inverter. For example, grounded PV Arrays will cause current leakage to the inverter.
- Make sure DC switch on "OFF" position. Otherwise please use an external PV switch to cut off the PV connection during wiring and when necessary.

NOTICE

- Use IEC61730 class-A Rating PV Arrays.

- To ensure IP65 protection, use the right PV plugs in the package.
- Damage to the device due to the use of incompatible terminals shall not be covered by the warranty.
- All wiring must be performed by a qualified personnel.

Suggested cable requirement for PV wires

Model	Wire Size	Cable	Beaker
3 ~5KVA	12AWG	4-6mm ²	25A

Wiring Connection Procedure

Step1: Assembling the PV Connector:

- Strip the insulation from each PV cable by 6–8 mm.
- Assemble the cable ends with the crimping pliers.
- Lead the cable through the cable gland and connect PV cable to PV connectors.
- Screw the cable gland and the insulator.

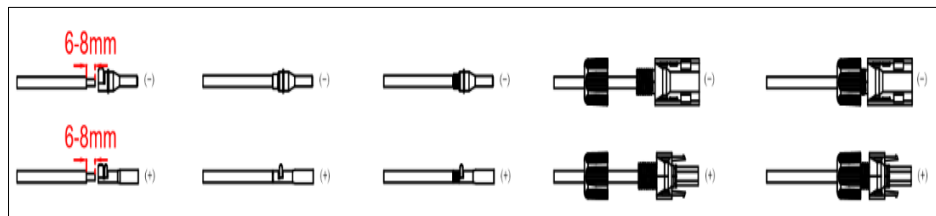

NOTICE

- DO NOT crimp the two metal sheets (below picture).
- These are fixing structure of metal core and its plastic shell. Crimping of the two metal sheets will result in failure of assemble, which may cause contact problems, and even fire in extreme cases.
- Measure the voltage of every route Strings using a Multi-meter.
- Ensure that the polarities of the DC input power cables are correct.

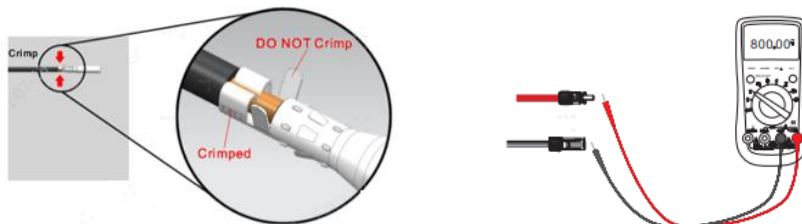

Step 2: Installing the PV Connectors

- Check the positive and negative polarity of the PV strings.
- Connect the PV connectors to the corresponding terminals until a “click” sound is heard.
- Seal the unused PV terminals with the terminal caps.

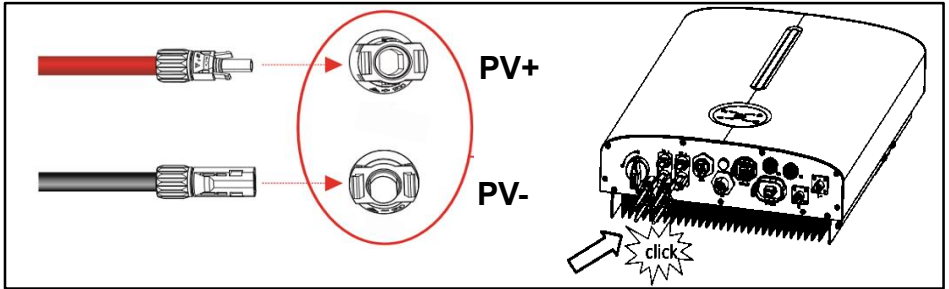

6.6 Battery Connection

Refer to the instructions supplied by the battery manufacturer for the connections on the battery side.

Battery connection diagram

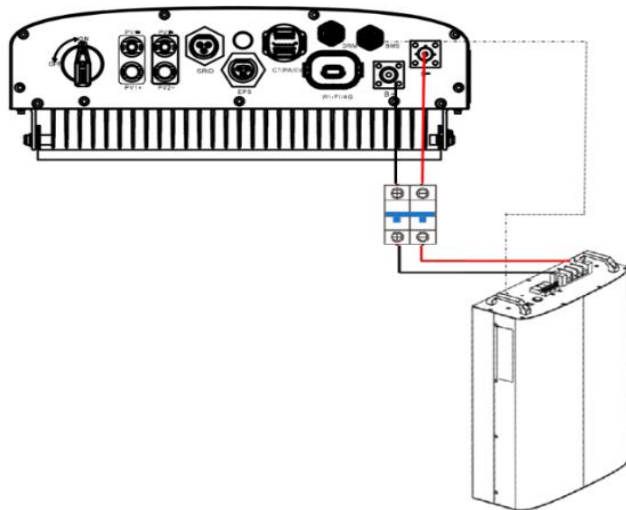

6.6.1 Battery Connection



DANGER

- Be careful against any electric shock or chemical hazard.
- Only use properly insulated tools to prevent accidental electric shock or short circuits. If insulated tools are not available, use electrical tape to cover the entire exposed metal surfaces of the available tools except their tips.
- Connect battery cables with correct polarity. If battery cables are reversely connected, the solar inverter may be damaged.
- The plug connector must be connected only by trained electricians.
- Do not disconnect under load! Battery can be placed in a no load state by shutting down the inverter completely.

NOTICE

- This inverter can only be connected with LIVOLTEK or Pylon low-voltage lithium batteries with nominal voltage from 40V to 60V now. If you choose other lithium batteries, please consult LIVOLTEK for compatibility. Otherwise inverter will not work normally.
- A two-pole DC circuit breaker with overcurrent protection should be installed between the inverter and the battery.

Wiring Connection Procedure

Use the right BAT plugs within the scope of delivery. Use the tin-plated cables with a conductor cross section of 25 mm² because the maximum battery current is 100A.

Step 1: Assembling the positive and negative connectors

- Remove an appropriate length of the insulation layer from the positive and negative power cables using a wire stripper.
- Insert the exposed areas of the positive and negative power cables into the BAT plugs of the positive and negative connectors respectively and crimp them using a crimping too.
- Lead the cable through the cable gland to insert into the insulator until it snaps into place. Then tighten the cable gland.

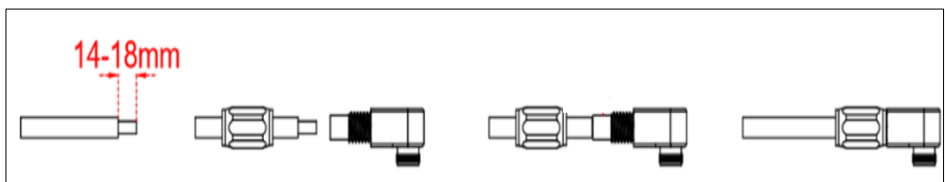

Step2: Connecting the Battery Connectors

Plug the battery connectors into the corresponding BAT+ and BAT- terminals at the bottom of the inverter. Ensure that the connectors are securely in place.

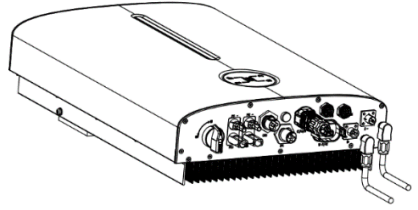

Step 3: Connecting the Battery

Connect the negative battery cable into the negative battery port and the positive battery cable into the positive battery port, and fasten the screws on the battery port by using a torque screwdriver.

If the connector from wire to battery is not assembled, you need to contact with your battery vendor for detailed information.

6.6.2 BMS Cable Connection

6.6.2.1 BMS Cable Connection

NOTICE

- Communication interface between inverter and battery is CAN with a RJ45 connector.
- The CAN cable enables the communication between the inverter and the Li-ion battery from Pylon (48V), LIVOLTEK.
- The battery communication can only work when the battery BMS is compatible with the inverter.

Wiring Connection Procedure

Step1: Assembling the BMS cable Connector

- Prepare a communication cable and insert the BMS cable connector which can be found in the scope of delivery.
- Crimp the communication cable with an Rj45 plug which is inside of the cable connector.

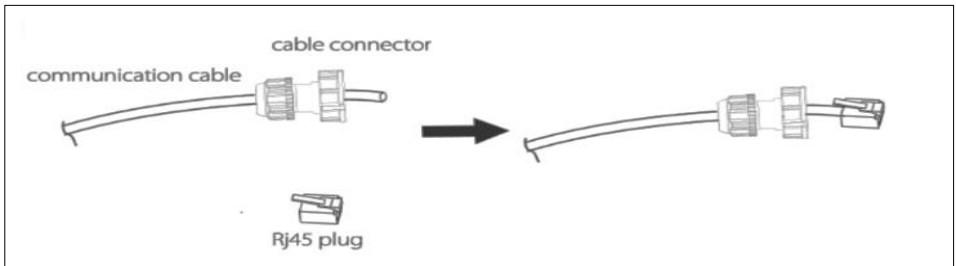

Step2: Installing the BMS Connector

- Insert the cable connector into BMS port on the inverter and screw it tightly.
- Then insert other side of communication cable into CAN port on the battery.

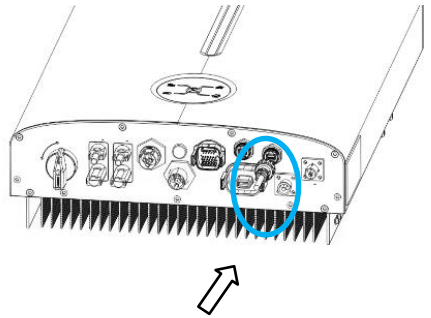

6.6.2.2 BMS Pin Definition

NOTICE

- The BMS Pin Definition for battery from the Pylontech and LIVOLTEK are different. Make sure the right wire sequence, otherwise will cause failure.

BMS Pin Definition for LIVOLTEK Lithium Battery

	Orange white	1. BMS_CAN_H
	Orange	2. BMS_CAN_L
	Green white	3. BMS_485_A
	Blue	4. GND
	Blue white	5. BMS_485_B
	Green	6. GND
	Brown white	7. NULL
	Brown	8. NULL

BMS Pin Definition for Pylontech Lithium Battery

	Green white	1.NULL
	Blue	2.GND
	Blue white	3.NULL
	Orange white	4.BMS_CAN_H
	Orange	5.BMS_CAN_L
	Green	6.NULL
	Brown white	7.NULL
	Brown	8.NULL

6.6.3 NTC Communication for Lead-acid battery (Optional)

The lead acid battery controls the inverter charging and discharging by NTC temperature sensing.

Procedure:

Step1: Please find the NTC cable and a piece of tape in the accessories package of inverter.

Step2: Make the tape adhere to NTC interface.

Step3: Please clean battery surface before sticking

Step4: Insert the RJ45 port of NTC into BMS port of inverter, and make the interface adhere to the battery interface (any place but must be nonmetallic).

6.7 WIFI/ 4G Connection (Optional)

The inverter provides a communication port, which can collect data and transmit data of the inverter to the monitoring website via Wi-Fi or 4G (Optional).

WIFI Stick (Wi-Fi & Bluetooth 2in1 function) implements communication with Cloud server through wireless network to monitor the inverter's data status. For more details, refer to WIFI Application Manual.

4G Stick (currently under development) implements communication with Cloud server through cellular to monitor PV inverter's data status. For more details, refer to GPRS Application Manual.

Wiring Connection Procedure

Step1: Remove the waterproof lid from the Wi-Fi/4G terminal.

Step2: Insert the Wi-Fi stick into the communication port. Slightly shake it by hand to determine whether it is installed firmly.

Step3: Build the connection between the inverter and router. Please refer to the Pocket Wi-Fi user manual to configure the WLAN.

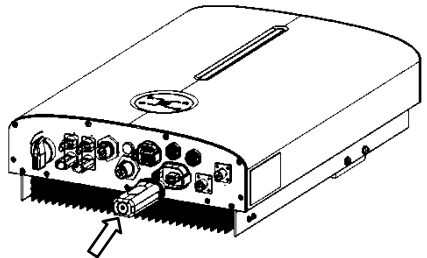

6.8 DRM Connection

The inverter supports the demand response modes as specified in the standard AS/NZS 4777. The inverter has integrated a terminal block for connecting to a DRED, as shown in the following figure.

Mode	Requirement
DRM0	Operation disconnect device
DRM1	Do not consume power
DRM2	Do not consume more than 50% of rated power
DRM3	Do not consume more than 75% of rated power AND Source reactive power if capable
DRM4	Increase power consumption (subject to constraints from other active DRMs)
DRM5	Do not generate power
DRM6	Do not generate more than 50% of rated power
DRM7	Do not generate more than 75% of rated power AND Sink reactive power if capable
DRM8	Increase power generation (subject to constraints from other active DRMs)

“DRM” Connector Pin Definition

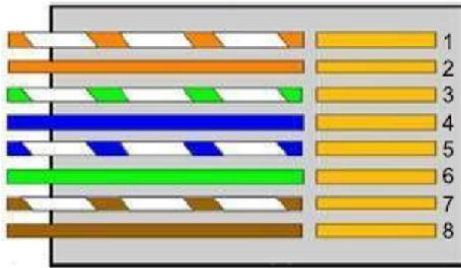

1. DRM1/5
2. DRM2/6
3. DRM3/7
4. DRM4/8
5. 3.3V
6. DRM0
7. 3.3V
8. GND

Wiring Connection Procedure

Step1: Unscrew the swivel nut from DRM port.

Step2: Lead the cable through the cable gland.

Step3: Remove the cable jacket and strip the wire insulation.

Step4: Plug the wires into the corresponding terminals.

Step5: Fasten the swivel nut with a torque of 4–5N.m and connect the other end to the DRED (DRED device is not provided by LIVOLTEK).

6.9 Multi COM Terminal Connection

The inverter provides 16pin terminals to facilitate you to install CT or Smart meter, parallel function or EV charger.

Follow the pin definition below to connect the Multi com communication cables. Do not remove the resistor or short circuit wire unless you are going to use the corresponding PINs.

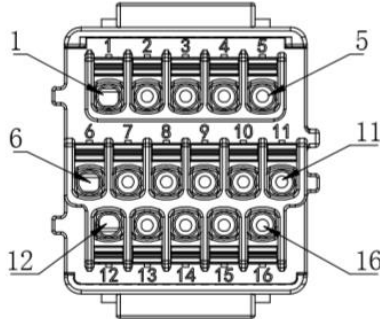

Signal definitions

Pin	Definition	Description	Pin	Definition	Description
1	Meter_485B	485 contact interface for Smart meter	9	SYNC-TXA	
2	Meter_485A		10	NC	
3	CT_IN1	485 contact interface for CT	11	NC	
4	CT_IN2		12	EV_485A	485 contact interface for EV charger
5	NC	N/A	13	EV_485B	
6	Paral_CANH	CAN contact interface for parallel connection	14	NC	
7	Paral_CANL		15	Dry-	Dry contact interface for generator
8	GND-C	16	Dry+		

Assembly reference drawing

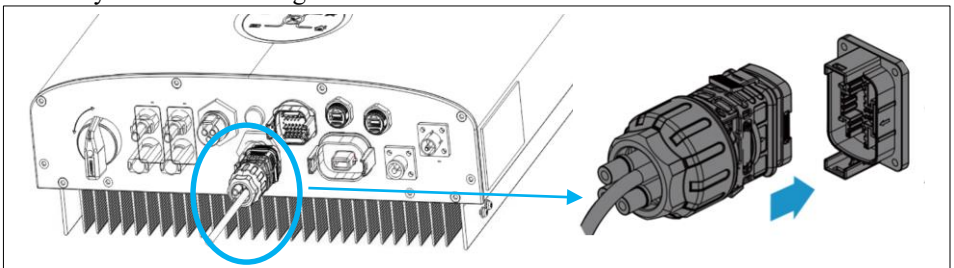

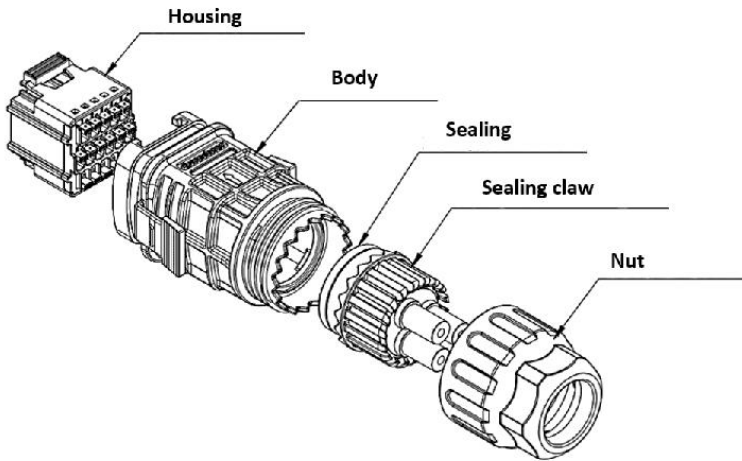

Wiring Connection Procedure

Notes: Assemble the communication module and plug it into the communication terminal directly if you are not going to use the communication functions.

Step 1: Prepare the communication cable and remove the plug of the communication terminal.

Step 2: Dismantle the communication module and take out the pin terminal. To avoid water and dust, keep the rubber plug to seal the unused holes.

Step 3: Insert the communication cable into the corresponding pins terminal to realize the RS485 communication function.

Step 4: Assemble the communication module and plug it into the communication terminal.

6.9.1 CTConnection

The hybrid inverter is equipped with the feed-in power limit function, so as to meet the requirements of some national standards or grid standards for the output power at the grid connection point. For the setting of feed-in power limit, refer to the section “Feed-in Limitation”

The CT (Current transformer) in the package of inverter is compulsory for this hybrid system installation. Which measures the value and direction of AC current. Thanks to its built-in metering chip, the hybrid inverter enables the export power to the grid does not

exceed a preconfigured limit.

NOTICE

- No meter or CT to the inverter will cause fault.
- If you want to install a smart meter instead of the CT, you can purchase from LIVOLTEK or buy it yourself.
- The smart meter must be authorized by LIVOLTEK, any third party or non-authorized meter may not match with the inverter. LIVOLTEK will not take the responsibility if the meter is unavailable.

NOTICE

- Do not place the CT on the N Wire or the earth wire.
- Do not place the CT on the N and L wire simultaneously.
- Do not place the CT with the arrow pointing to the inverter side.
- Do not place the CT on the non-insulated wires.
- Important: The arrows direction on the CT must point to the public grid side.

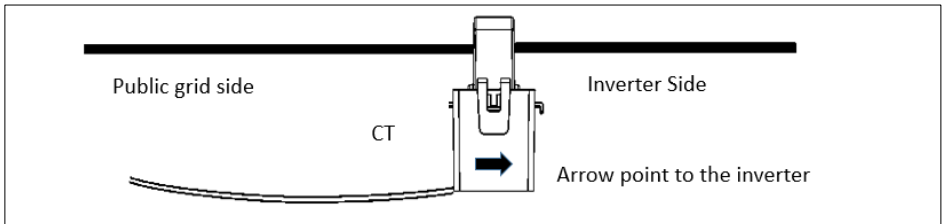

CT Pin Definition

Red—CT-1, White—CT-2

6.9.2 Smart Meter Connection(Optional)

When customer needs to use meter to monitor the energy flow, the meter terminal connection steps are as follows:

NOTICE

- Make sure AC cable is totally isolated from AC power before connecting Smart Meter.
- One Smart Meter can only be used for one hybrid inverter.
- Normally the smart meter should be placed in or near the grid distribution box right after the billing meter.

- Please use the smart meter cable in the accessory box for communication.

Wiring Connection Procedure

Step1: Assembling the BMS cable Connector

1. Make LAN cable with RJ45 terminal.
2. Thread the swivel nut over the LAN cable.
3. Press the cable support sleeve out of the cable gland.
4. Remove the filler plug from the cable support sleeve.
5. Route the LAN cable through an opening in the cable support sleeve.
6. Thread the LAN cable through the cable gland.

Step2: Insert the RJ45 plug of the network cable into the pin connector on the inverter until it snaps into place.

Meter Connector Pin Definition

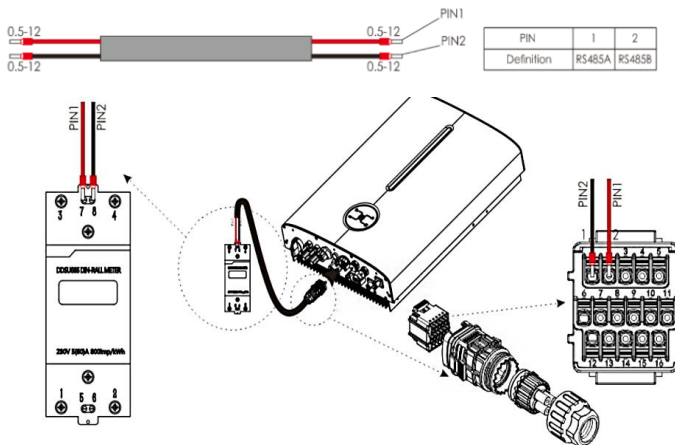

Procedure

Step 1 Connect the signal cable to the signal cable connector.

Step 2 Connect the signal cable connector to the COM port.

Step 3 Securing the signal cable connector

6.9.3 Parallel Connection(Optional)

Parallel Connection function of the hybrid inverter is a solution for system capacity extension to provide bigger power. This inverter supports 2 units in parallel now (need to purchase an additional parallel kits). For the specific operation, please refer to the parallel instructions.

Notes:

- ✧ Only two units with the same capacity, voltage and frequency can be coupled via the provided parallel cable to run in parallel mode.
- ✧ In Parallel system, one inverter will be set as the "Master inverter" which will control the other inverter's energy management and dispatch control.
- ✧ In Parallel system, the grid input and the load outputs can be connected in parallel.
- ✧ In Parallel system, the two inverters communicate through the provided RJ45 parallel communication cable (PAL cable).

6.9.4 EVcharger Connection

This inverter is ready for you to use solar energy to charge your electric car. For specific operations, please refer to the LIVOLTEK EV charger user manual.

Notes: This inverter can only be connected with LIVOLTEK EV charger now.

6.10 Installation Verification

Check the following items after the inverter is installed.

- No other objects put on the inverter.
- All screws especially the screws used for electrical connections are tightened.
- The inverter is installed correctly and securely.
- Ground, AC, DC and Communications cables are connected tightly correctly and securely.
- Check there is no open circuit or short circuits at AC and DC terminals using multi-meter.
- Idle terminals are sealed.
- All safety warning symbols are intact and complete on the inverter.

7. System Operation

7.1 LEDs Display

The inverter operation status can be obtained from observing LED indicator status.

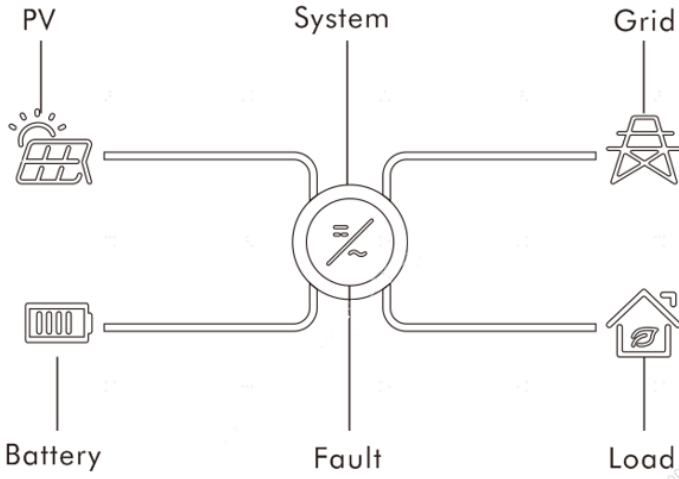

Color	Status	Description
Green	on	The inverter is running normally
	off	Other statuses except Running
Red	on	Fault occurs
	off	No fault occurs
Green/Red	blink	System startup or updating

You can monitor & set data of the inverter through the LIVOLTEK APP. For details about operation, refer to APP User Manual. APP User Manual is available for free from website.

LED indicator status for common fault of the inverter:

Error Message	PV	BATTERY	GRID	LOAD	SYSTEM	FAULT
Starting up	X	X	X	X	★	★
Normal status	⊙	⊙	⊙	⊙	●	X
WI-FI communication	⊙	⊙	⊙	⊙	●	X
PV energy weak	⊙	⊙	⊙	⊙	●	X
PV over Volt	●	⊙	⊙	⊙	X	●
PV over current	●	⊙	⊙	⊙	X	●
PV Strings Reverse	●	⊙	⊙	⊙	X	●
EPS Volt Fault	⊙	⊙	⊙	●	X	●
EPS Over Load	⊙	⊙	⊙	●	X	●
EPS Short Fault	⊙	⊙	⊙	●	X	●
BMS Lost	⊙	●	⊙	⊙	X	●
BMS Fault	⊙	●	⊙	⊙	X	●
Inter CKT Fault	●	●	●	●	X	●
Inter Com Fault	●	●	●	●	X	●
EEPROM Fault	●	●	●	●	X	●
Leakage Over Current	●	●	●	●	X	●
Earth Fault	●	●	●	●	X	●
MET/CT Fault	●	●	●	●	X	●
PAL Multi Master	X	X	X	X	X	●
PAL Com Fault	X	X	X	X	X	●
PAL SN Fault	X	X	X	X	X	●
PAL HWC Fault	X	X	X	X	X	●
PAL FWC Fault	X	X	X	X	X	●
PAL SLV Fault	X	X	X	X	X	●

● means light on, X means light off , ★ means blink, ⊙ means keep original status.

7.2 System Commissioning

Check the following items before starting the inverter:

- The country marked on the packing box is in accordance with the installation site.
- The inverter is correctly and firmly fastened to the mounting bracket on the wall.
- All cables are connected according to chapter 6;
- All unused terminals are properly sealed.
- AC circuit breaker is correctly connected between inverter GRID port & GRID, circuit breaker is disconnected.
- AC circuit breaker is correctly connected between inverter LOAD port & critical loads, circuit breaker is disconnected.
- For lithium battery, please ensure that the communication cable has been correctly connected.
- For the lead-acid battery, please ensure that the NTC wire has been correctly connected.

If all of the items mentioned above meet the requirements, proceed as follows to start up the inverter for the first time.

Step 1: Power on the Grid

- Connect the AC circuit breaker.

Step 2: Power on the Battery

- Connect the external DC circuit breaker between the inverter and the battery, then power on the battery manually if a battery is equipped.

Step 3: Power on the PV

- Rotate the DC switch to “ON”. Wait for a moment and the inverter will start a self-test procedure.

Step 4: Switch on the loads

- The load parameters should show.

Step 5: Configure the Wi-Fi stick

- Establish communication connection between the mobile phone and Wi-Fi stick, then set initial protection parameters. Refer to LIVOLTEK APP Operation Instructions for details.

Step 6: Self-test in accordance with CEI 0-21 (Italy Only)

- The self-test is only required for inverters to be commissioned in Italy. During the self-test, the inverter will consecutively check the reaction times for: overvoltage,

under-voltage, maximum frequency and minimum frequency.

- Please use the LIVOLTEK APP to initiate the self-test procedure and get the test results. Refer to “Settings on the APP” for details.

Step7: Observe the LED indicator

- Observe the LED indicator to ensure that the inverter operates normally.

7.3 System Decommissioning

For maintenance or other service work, the inverter must be switched off. Proceed as follows to disconnect the inverter from the AC and DC power sources.

Notes:Please strictly follow the following procedure. Otherwise it will cause lethal voltages or unrecoverable damage to the inverter.

Step1: Turn off the loads;

Step2: Turn off the PV;

Step3: Turn off battery;

Step4: Turn off the main grid switch;

Step5: Wait for at least 5 minutes after the LED and graphical display black out for the internal circuits to discharge energy;

Step6: Disconnect all the power cables;

Step7: Disconnect all the communication cables, Remove the Wi-Fi stick;

Step8: Remove the inverter from the wall, also remove the bracket if necessary;

Step9: Pack the inverter with the original carton, and store it.

8. Settings on the APP

8.1 UserInterface Introduction

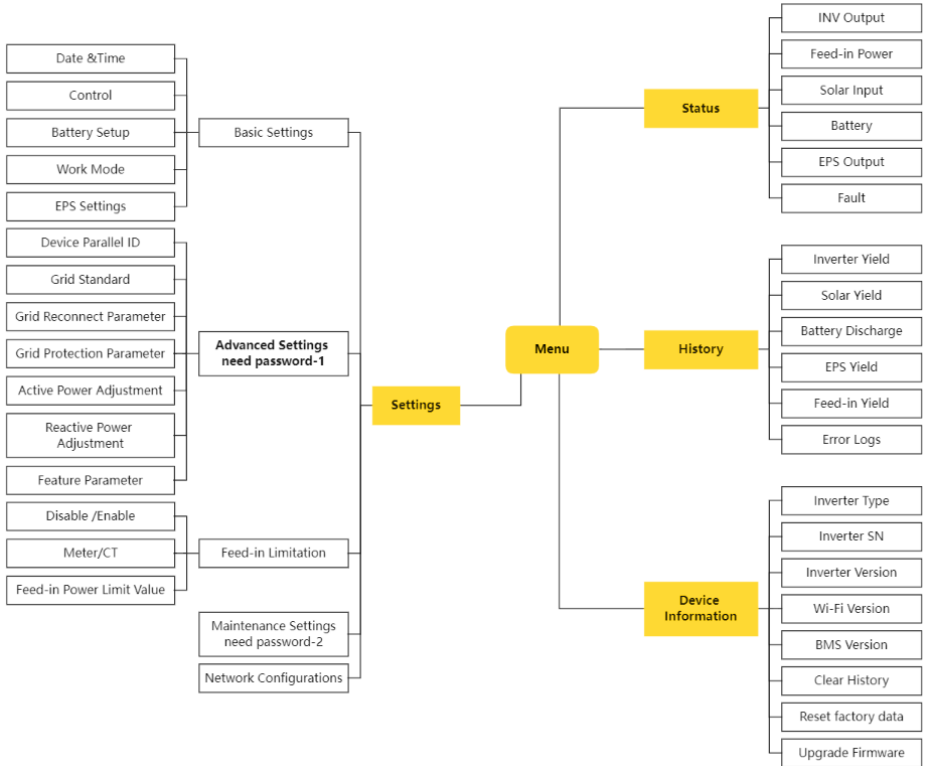

8.2 Download and Install

Preparation

- Power the inverter and/ or Wi-Fi router on;
- Make sure the Wi-Fi stick is connected to the inverter and the network is configured.

Procedure:

Method1: Search for the keyword "Livolttek" from Google Play Store or Apple AppStore, download and install the latest version of the monitoring software for free.

Method2: Scan the following QR code and download the latest installation package.



Step1: Install LIVOLTEK APP

Step2: Wi-Fi Configuration

- Click on "Local Mode" ----> "Bluetooth Mode".
- Find your inverter SN (named with "BLF-HP1- xxxx").
- Click on "⚙️" to go setting.
- Click on "Network Configurations"----> Choose "Wi-Fi"
- Enter wireless network name & password
- Click on "Confirm" and wait 10s, "Success" will display on the APP if successful.

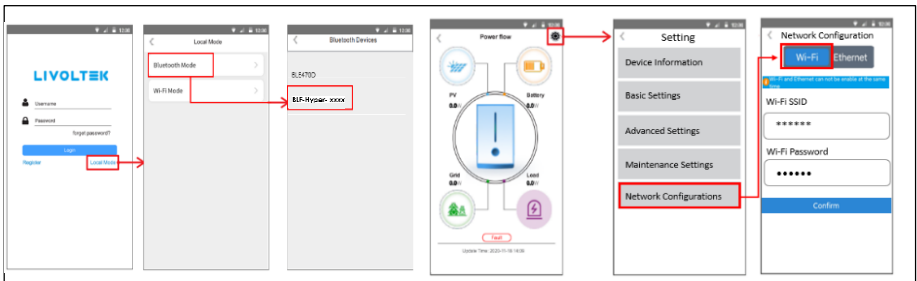

Step 3: Registering an Installer Account

Open the app and login with the username & password. Register it first if you don't have an account, which provides access to the remote monitoring and management.

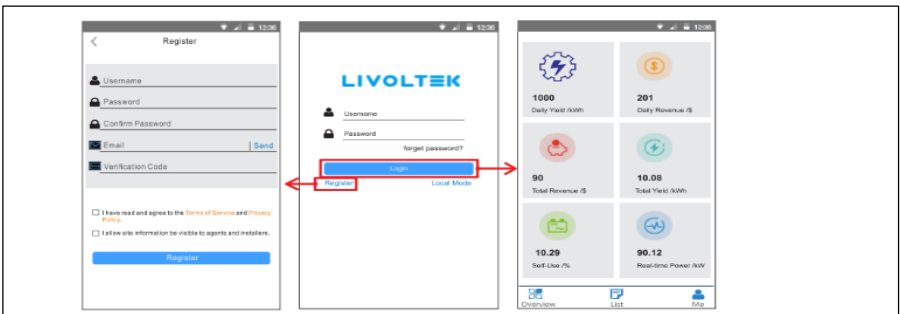

9. Troubleshooting and Maintenance

WARNING

- Before maintaining and commissioning inverter and its peripheral distribution unit switch off all the charged terminals of the inverter, and wait at least 10 minutes after the inverter is powered off.

9.1 Troubleshooting

When the inverter has an exception, its basic common warning and exception handling methods are shown in the table below.

Alarm Name	Possible causes	Suggestion
PV1 Over Volt	PV input voltage is not within permissible range.	Check the voltage and number of PV modules and adjust it if need. Wait for recovery or restart the system.
PV2 Over Volt		
PV1 Over Current	PV input current is not within permissible range.	Check the PV input power and configuration. Wait for recovery or restart the system.
PV2 Over Current		
PV1 Strings Reverse	The cables of PV strings are connected reversely.	Disconnected the DC Switch. Check the cables of PV strings and reconnect the cables if need.
PV2 Strings Reverse		
PV Energy Weak	Insufficient power supply from PV strings.	When sunlight intensity weakens, no action is needed. Otherwise, check if there is shielded, or short circuit, open circuit etc. in the PV strings.
Leakage Over Current	The leakage current exceeds the permissible range.	Check PV cable ground connection and adjust it if need. Contact your dealer for technical support if the error happens again.
Earth Fault	The earth fault occurs	Check the connection of grounding and the L-line & N-line and adjust it if need. Contact your dealer for technical support if the error happens again.
AC Volt Fault	AC voltage is not within permissible range.	Check the setting of the safety country and AC voltage (L & N).
AC Freq Fault	Grid frequency is not within permissible range.	Check the setting of the safety country, frequency and the connection of AC cables. Contact your dealer for technical support if the error happens again.

EPS Volt Fault	Output Voltage abnormal (Inverter voltage is higher than 260Vac)	Check if the load power is within the EPS power range and the AC output wires are connected well.
EPS Over Load	Overload error. The inverter is overload 110% and time is up(more than Five time)	Reduce the connected load by switching off some equipment, and wait for the recover. Restart the inverter and contact your dealer for technical support if the error happens again.
EPS Short Fault	EPS output short circuit	Check the wires connection. Restart and contact your dealer for technical support if the error happens again.
Inter CKT Fault	BUS Voltage (AC) is too high.	Wait for inverter recovery. Contact your dealer for technical support if the error happens again.
Inter CKT Fault	Over Current fault.	
Inter CKT Fault	Component failure.	
Inter Temp High	The ambient temperature inside the inverter exceeds the upper limit.	Check the air flow of the unit, then close it and wait for 30mins. Contact your dealer for technical support if the error happens again.
BAT Temp High	Battery (Lead-Acid) temperature is not within permissible range.	Check the environment temperature. Contact your dealer for technical support if the error happens again.
BAT Volt Fault	Battery voltage is not within permissible range.	Check the spec and quantity of battery and the connection. Contact your dealer for technical support if the error happens again.
BMS Lost	BMS Communication lost.	Check battery type and communication of the BMS cable. Restart the inverter and contact your dealer for technical support if the error happens again.
Low battery	The battery voltage is too low.	Re-charge battery and contact your dealer for technical support if the error happens again.
Inter CKT Fault	Over Current occurs during battery charging or discharging.	Restart the inverter and contact your dealer for technical support if the error happens again.
	BUS Voltage is too high or internal failed	
	Internal communication failure (ARM&DSP).	
	Internal EEPROM Component (ARM) damaged.	
	BMS communication failure.	

PAL Com Fault	Communication faults between the master and the slave inverter.	Check the parallel communication cable and adjust it if need. Restart the inverter and contact your dealer for technical support if the error happens again.
PAL Multi Master	The master-slave identity of the inverter is set incorrectly.	Check the number of the inverters and adjust it if need.
PAL SN Fault	The product models or output power of the two inverters do not match.	Check the product model and power of the parallel inverters and replace it if there is inconsistent. Contact your dealer for technical support if the error happens again.
PAL HWC Fault	The hardware codes are not compatible	Contact your dealer for technical support.
PAL FWC Fault	The firmware codes are not compatible	
PAL SLV Fault	Parallel system stop due to various reasons.	Check the 2 inverters working status. Restart the inverters and contact your dealer for technical support if the error happens again.
MET/CT Fault	Meter or CT self-check fault.	Check the power cable connection. Contact your dealer for technical support if the error happens again.

9.2 Maintenance

To ensure that the inverter can operate properly for a long term, you are advised to perform routine maintenance on it as described in this chapter.

 CAUTION
<p>Risk of inverter damage or personal injury due to incorrect service!</p> <ul style="list-style-type: none"> • Always keep in mind that the inverter is powered by dual sources: PV strings and utility grid. • Before maintaining and commissioning inverter and its peripheral distribution unit switch off all the charged terminals of the inverter, and wait at least 10 minutes after the inverter is powered off.

Routine Maintenance

Check Item	Method	Period
System clean	Check the temperature and dust of the inverter. Clean the inverter enclosure if necessary.	Once every 6 to 12 months
System running status	Check whether the inverter is not damaged or deformed or can be operated with no abnormal sound.	
Cable entry	Check whether the cable entry is insufficiently sealed, or the gap is excessively large, and reseal the entry when necessary.	
Electrical connection	Check whether all cables are firmly in place. Check whether a cable is damaged, especially the part contacting the metal enclosure.	

9.3 Removing the Inverter

Perform the following procedures to remove the inverter:

Step 1: Disconnect all cables from the inverter including communications cables, DC input power cables, AC output power cables, and PGND cables.

Step 2: Remove the inverter from the rear panel.

Step 3: Remove the rear panel.

 WARNING
<ul style="list-style-type: none"> Before removing DC input connector double check DC input switch, is turned to OFF to avoid inverter damage and personal injury.

9.4 Disposal of the Inverter

The inverter and its packing case are made from environment-friendly materials. If the inverter service life has expired, do NOT discard it with household garbage; dispose the inverter in accordance with local environmental laws and regulations.

10. Technical Data

PV Input Data	Hyper-3000	Hyper-3680	Hyper-4600	Hyper-5000
Max. PV Input Power (Wp)	4500	5520	6900	7500
Max. PV Input Voltage (V)			600	
Nominal DC Input Voltage (V)			360	
MPPT Voltage Range (V)			125~550	
No. of MPPTs/Strings per MPPT	1 / 1	2 / 1	2 / 1	2 / 1
Max. Input Current (A)	14	14/14	14/14	14/14
Max. Short Circuit Current (A)	17.5	17.5/17.5	17.5/17.5	17.5/17.5
AC Output @ Grid				
Nominal AC Power (W)	3000	3680	4600	5000
Max. Apparent Output Power (VA)	3300	4000	4600	5500
Nominal AC Voltage (V)			220/230/240	
Nominal AC Voltage Range (V)			186~290	
Nominal Grid Frequency (Hz)			50/60	
Max. AC Current (A)	13.0	16.0	20.0	21.7
THDi (@Rated Power) (%)			<3	
Power Factor	~1 (Adjustable from 0.8 leading to 0.8 lagging)			
EPS Output @ Off Grid				
Nominal EPS Power (W)	3000	3680	4600	5000
EPS Peak Power [VA]	1.1 x Pnom, 10 sec; 1.5 x Pnom, 1 sec			
Nominal Output Voltage (V)			220/230	
Nominal Frequency (Hz)			50/60	
Nominal Output Current (A)	13.0	16.0	20.0	21.7
THDv (@Linear Load) (%)			< 3%	
Back-up Switch Time (ms)			<20	
Battery Data				
Battery Type	Lead-acid/Lithium			
Nominal Battery Voltage (V)			48	
Battery Voltage Range (V)			40~60	
Battery Capacity (Ah)			50~500	
Max. Char/Discharge Current (A)	60	80	100	100
Communication with BMS			CAN	
Efficiency				
Max. Efficiency (%)	97.6		97.8	

Euro Efficiency (%)	97.1	97.4
Protection		
DC Switch		Integrated
PV Reverse Polarity Protection		Integrated
Output Over Current Protection		Integrated
Output Short Circuit Protection		Integrated
Output Over Voltage Protection		Integrated
Anti-islanding Protection		Integrated
Insulation Resistor Detection		Integrated
Residual Current Detection		Integrated
Ground Fault Monitoring		Integrated
General Data		
Dimensions(W*H*D mm)		414*625*155
Weight (kg)	29	30 30 30
Mounting Method		Wall-mounting bracket
Protection Rating		IP65
Cooling		Natural convection
Operating Temperature Range (°C)		-25~+60°C (>45°C derating)
Max. Operating Altitude (m)		2000
Noise (dB)		<25
Relative Humidity		0~100%,no condensation
Display		LED & APP
Communication		RS485 for Parallel/EV charger, CAN for BMS,USB for Wi-Fi, CT
Topology		High frequency isolation (for battery)
Certificates		
EMC		EN61000-6-1 -2-3-4, EN61000-4-16, EN61000-4-18, EN61000-4-29
Safety		IEC/EN62109-1 & -2,IEC62040-1 G98, G99;AS/NZS4777.2; C10/11; RD1699;
Grid Regulations		UTE C 15-712-1; EN50549;IEC61727; NRS097-2-1

Notes: (1) Backup output power depends on the battery.

(2) Specifications are subject to change without further notice.

11. Disclaimer

The Hyper series inverters are transported, used and operated under limited condition, such as environmental, electrical etc. SPAZIO POWER shall not be liable to provide the service, technical support or compensation under conditions listed below, including but not limited to:

- Inverter is damaged or broken by force majeure (such as earthquake, flooding, thunderstorm, lighting, fire hazard, volcanic eruption etc.).
- Inverter's warranty is expired and doesn't buy extended warranty.
- Can't provide the inverter's SN, warranty card or invoice.
- Inverter is damaged by man-made cause.
- Inverter is used or operated against any items in local policy.
- Inverter's installation, configuration, commissioning doesn't follow the requirements mentioned in this manual.
- Inverter is installed, refitted or operated in improper ways mentioned in this manual without authority from SPAZIO POWER.
- Inverter is installed, operated under improper environment or electrical condition mentioned in this manual without authority from SPAZIO POWER.
- Inverter is changed, updated or disassembled on hardware or software without authority from SPAZIO POWER.
- Obtain the communication protocol from other illegal channels.
- Build monitoring, control system without authority from SPAZIO POWER.
- SPAZIO POWER will keep right to explain all the contents in this user manual.

Warranty Card Registration

Dear customer, thank you for choosing a SPAZIO POWER product. For registering your product warranty, please prepare everything and register on

<https://www.livolttek.com/registration.html>.

Product Information	
Product Type	
Product S/N	
Installation date	
Installation Company	
Personal Information	
Your name	
Your contact number	
Your Email address	
Your home address	

*Warranties should be registered within 36 months of installation, however it is recommended that they are registered no more than 6 weeks following the successful installation and commissioning of the Product where possible, thanks for your cooperation.



Contact

SPAZIO POWER a division of Spazio Lighting (PTY) LTD

Address: 52 Andries Street, Wynberg, Sandton, South Africa, 2090

Tel: +2711 555 5555

Email: info@spazio.co.za

Web: www.spaziopower.co.za