



Línea MOVILLE

Mobiliario General

En este catálogo se presentan dos líneas de mobiliario de oficina: Moville y Qualium, las cuales presentan una gran cantidad de configuraciones adaptables para una oficina pequeña hasta grandes corporativos.

La línea Moville se compone de 6 diferentes soportes configurables con diferentes formas de cubiertas para formar escritorios individuales, grupos de trabajo, oficinas ejecutivas y centros de operación. Todos los escritorios cuentan con un pasacables plástico bajo cubierta para poder realizar el cableado de manera organizada y estética.

La línea Qualium es ideal para oficinas ejecutivas y directivas, sus soportes en L.P. y cubiertas ergonómicas presentan una imagen corporativa moderna y distinguida.



Índice:

Línea Operativa

Línea Galatea-W

Mesas Configurables Galatea-W

Línea Space Plus

Línea Metra 1

Línea Metra 2

Línea Qualium

Línea Paquetes Qualium

 **WOODS**
muebles para oficina, s.a.



Línea Operativa:

Conjunto de escritorios, laterales, credenzas, mesas de trabajo con las siguientes especificaciones.

a) Cubiertas fabricadas en LP de 28 mm, colores de línea cubiertas rectas, curvas y semicurvas.

b) Costados y tapa piernas fabricados en LP de 19mm color blanco, gris y negro.

Las peninsulas tienen una pata circular metálica, blanca, gris o negra según sea el caso, en tubo de 5cm de diámetro con una base circular metálica.

Toda la línea se puede surtir desarmada ó en caja ya que su ensamble es muy sencillo, mediante tornillos.

Opcional:

- Cubiertas en chapa de encino.
- Cubiertas en cristal de color, adherido a la cubierta.

Nota: Ninguna de estas opciones se puede surtir en caja.

Puede llevar mini mampara adicional de laminado plástico ó melamina de 19 mm. al color del mueble ó en los colores de línea (ver muestrario) con los cantos de PVC al color de la cubierta, incluye adaptador para fijar escritorio.

Nota: Estas mini mamparas y sus accesorios fijadores se venden por separado ya que no son parte integral del mueble.

Esta línea se puede surtir armada ó desarmada en caja, incluye empaque certificado, tornillería necesaria para su ensamble y armado, así como instructivo de armado.

Armada* Preguntar área de cobertura.

Desarmada** Preguntar área de cobertura, precio y cubijaje de cada modelo para su envío por fletera ó revisar con costo adicional.

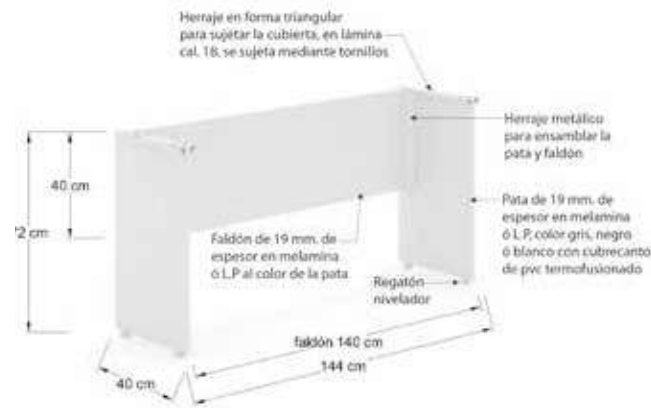
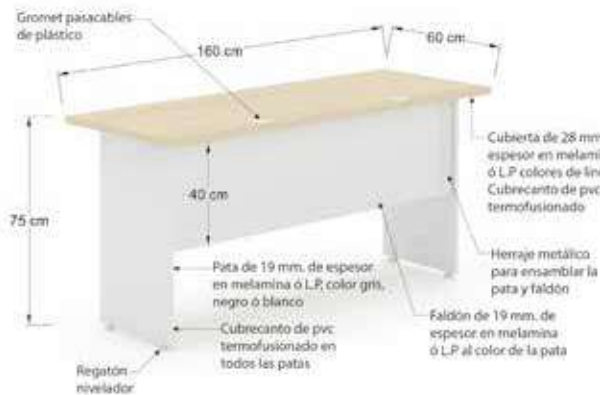
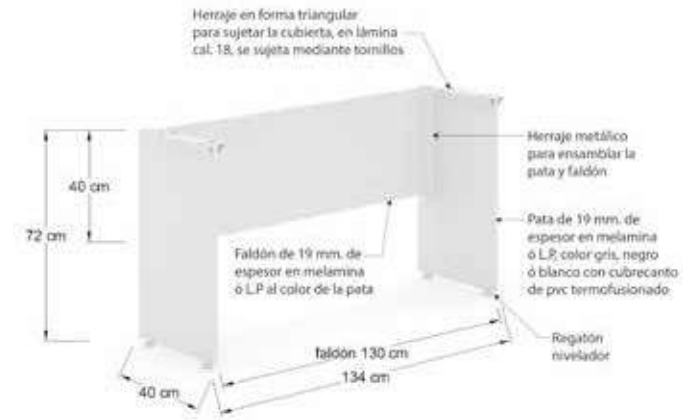

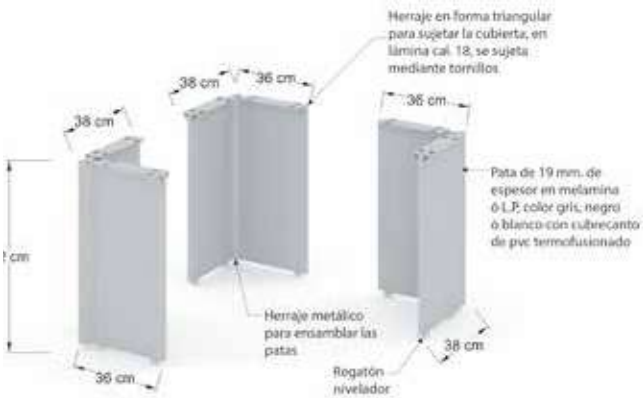
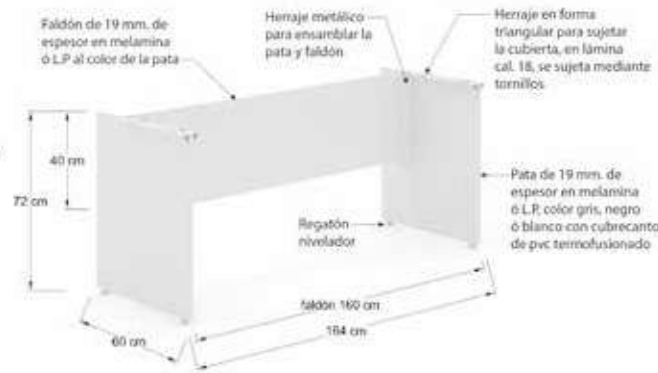
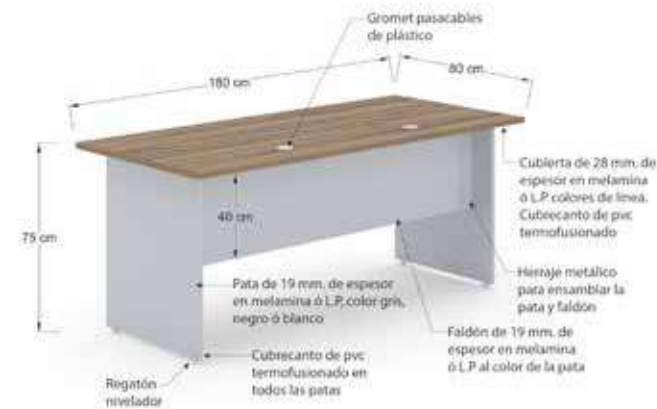
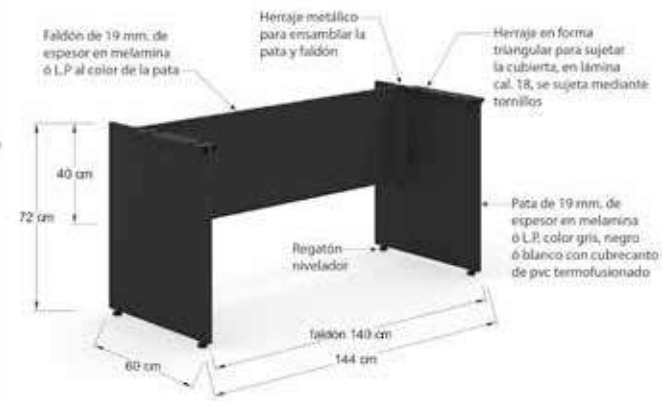
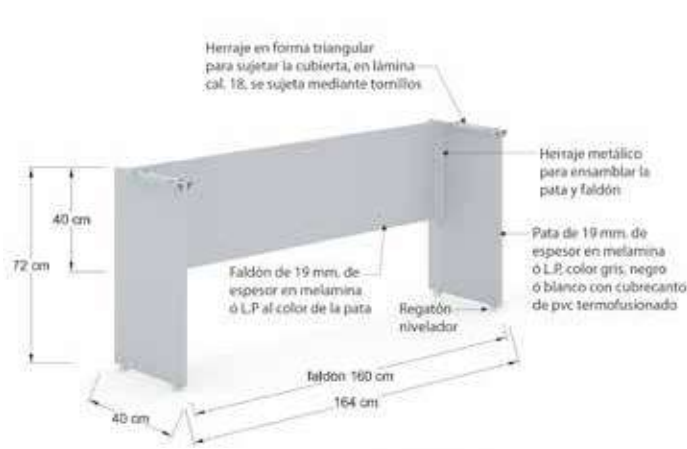

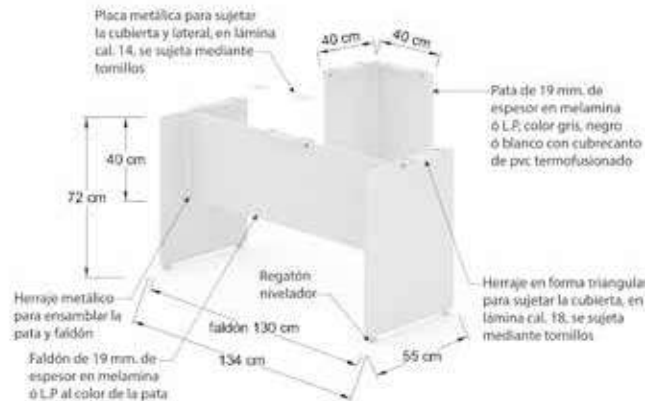
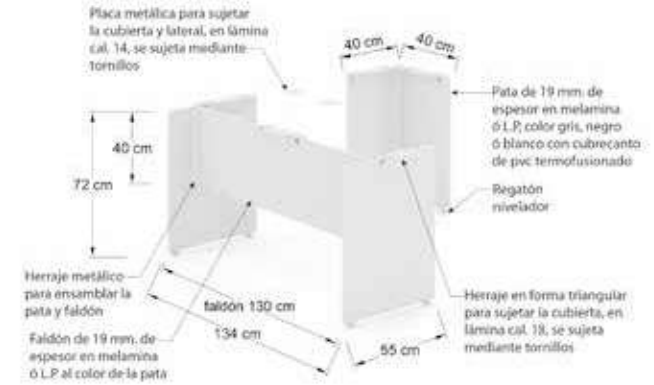
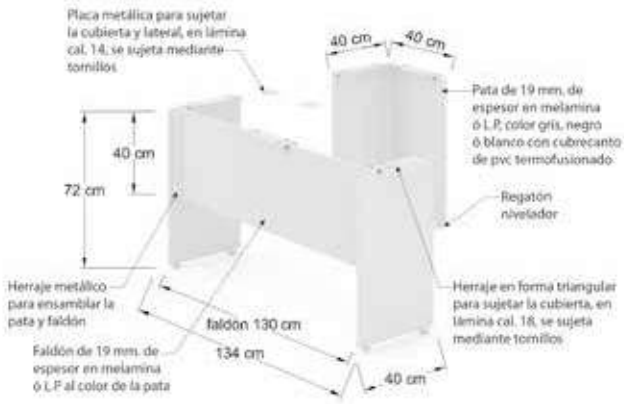
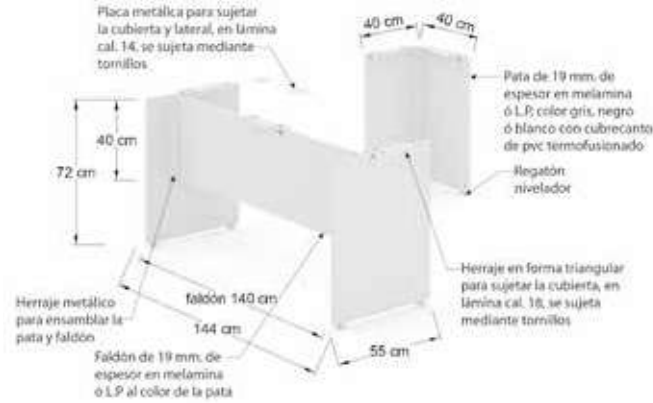
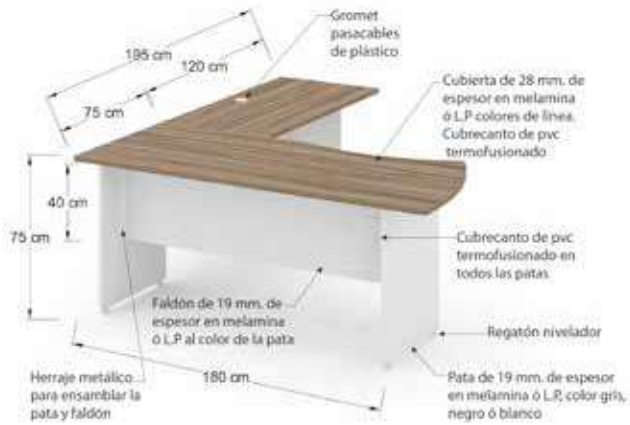

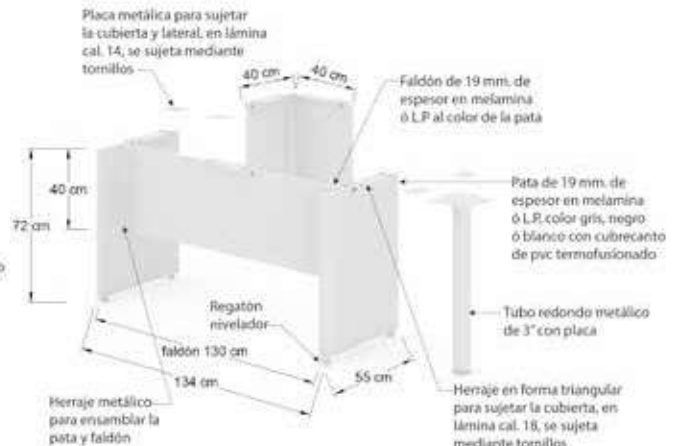
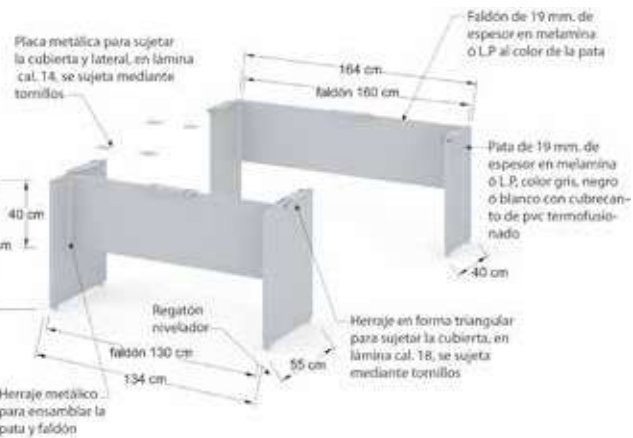
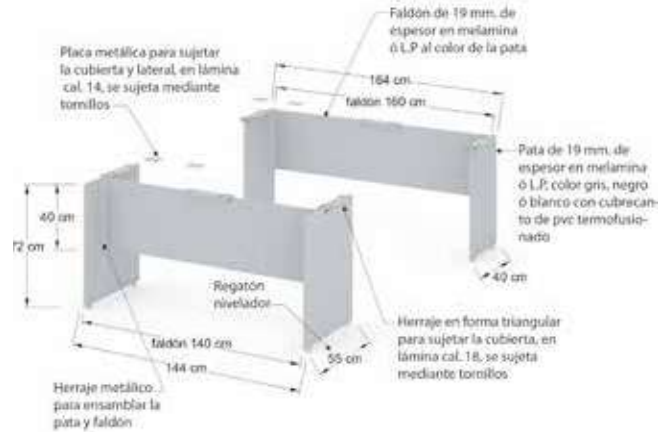
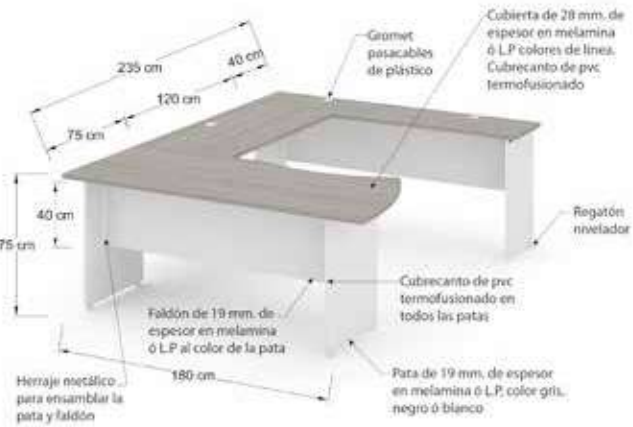
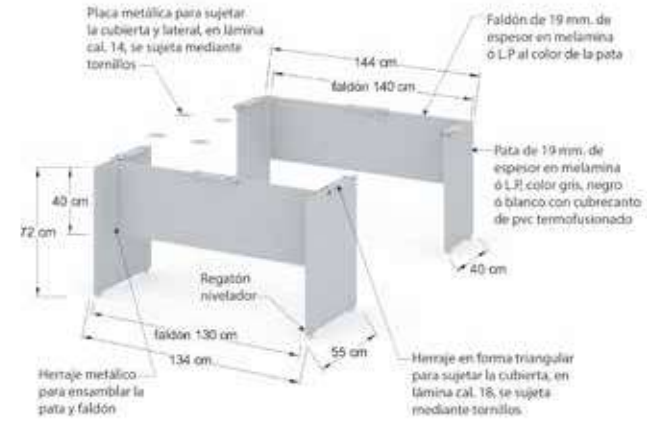
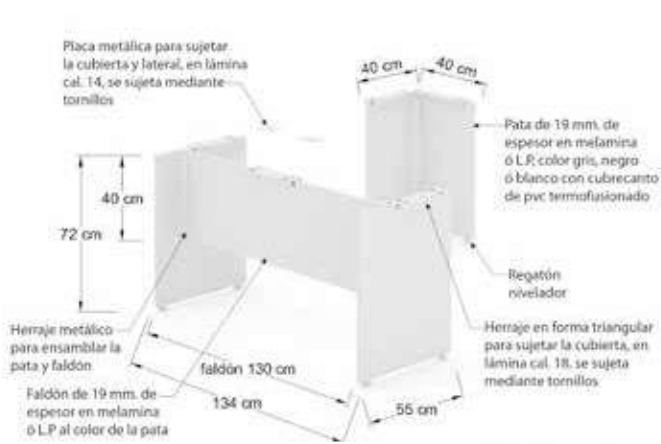

Características

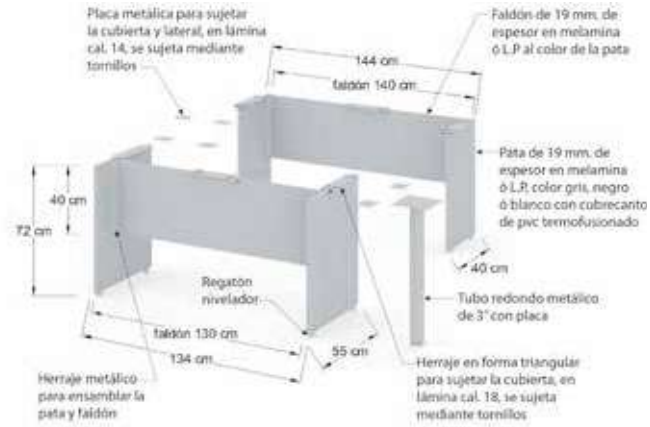
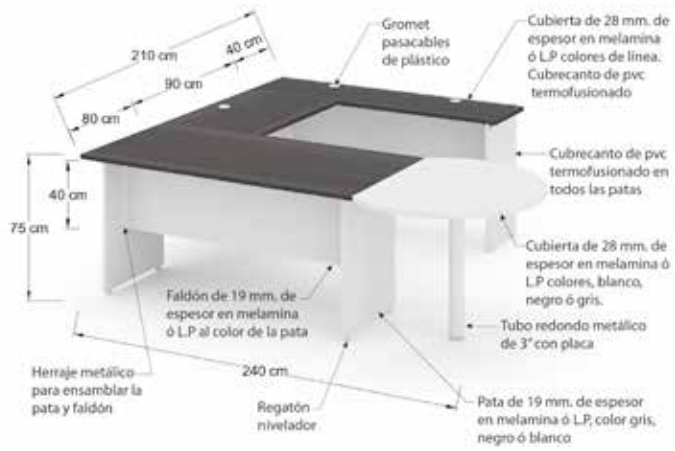











O08



O013



O015



O616



O618



O816



O818



PDHO18



ESHOP18



OPHOP16



ESPOP18



OPPOP16



POROP16



O16



O17



ESGOP16



PDPOP18



SEPOP16



PGDOP24



PEGOP24



CCB06



CTB03

**Línea Galatea:**

Conjunto de escritorios, laterales, credenzas, mesas de trabajo con las siguientes especificaciones.

a) Cubiertas fabricadas en LP de 28 mm, colores de línea. cubiertas rectas, curvas y semicurvas.

b) 4 patas independientes fabricadas en tubo redondo de 2 pulgadas calibre 18 en pintura negra, gris ó blanca, con regatones niveladores y remate decorativo inferior en pintura azul, naranja, amarillo, verde, rojo, gris, blanco y negro.

c) Las peninsulas tienen una pata circular metálica, blanca, gris ó negra según sea el caso, en tubo de 5 cm de diámetro con una base circular metálica.

Toda la línea se puede surtir desarmada ó en caja ya que su ensamble es muy sencillo, mediante tornillos.

Puede llevar mini mampara adicional de laminado plástico ó melamina de 19mm. al color del mueble ó en los colores de línea (ver muestrario) con los cantos de PVC al color de la cubierta, incluye adaptador para fijar al escritorio.

Nota: Estas mini mamparas y sus accesorios fijadores se venden por separado ya que no son parte integral del mueble.

Esta línea se puede surtir armada ó desarmada en caja, incluye empaque certificado, tornillería necesaria para su ensamble y armado, así como instructivo de armado.

Armada* Preguntar área de cobertura.

Desarmada** Preguntar área de cobertura, precio y cubijaje de cada modelo para su envío por letera ó revisar con costo adicional.

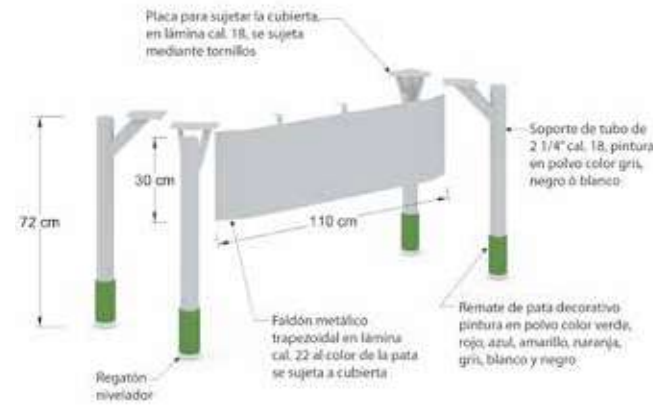
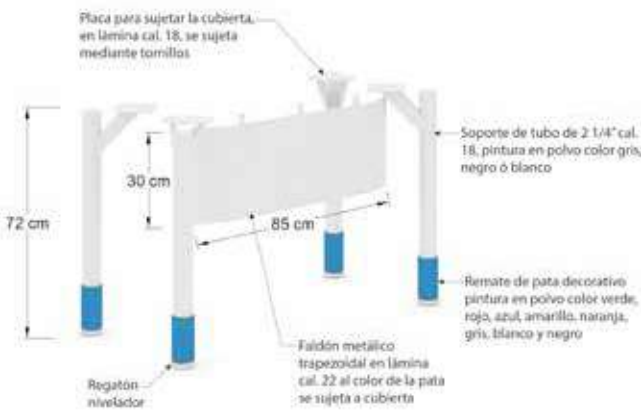

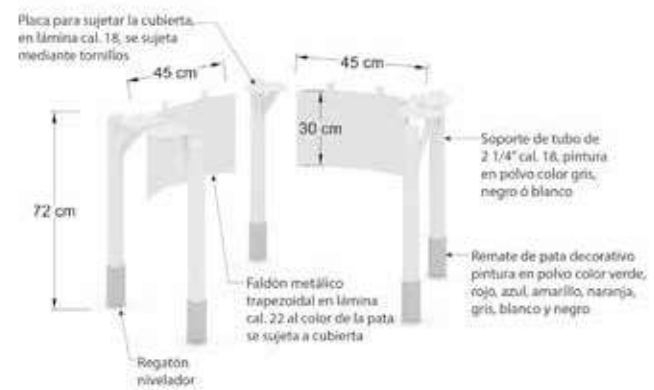
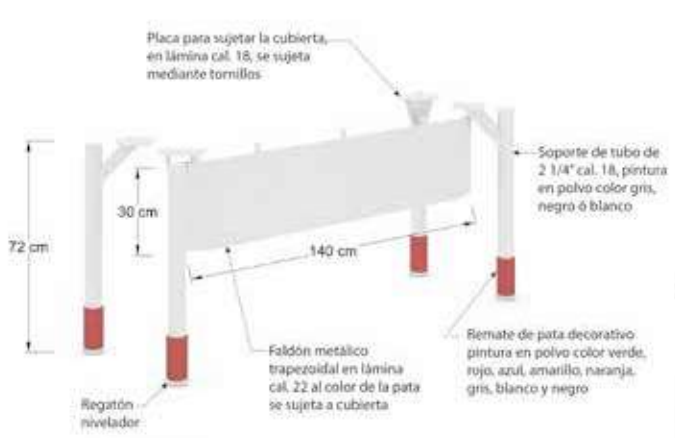

Características

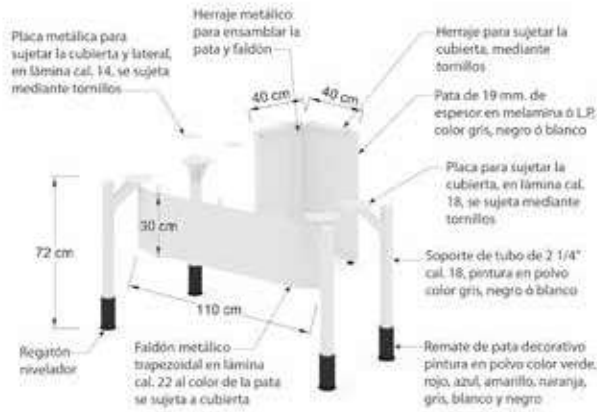
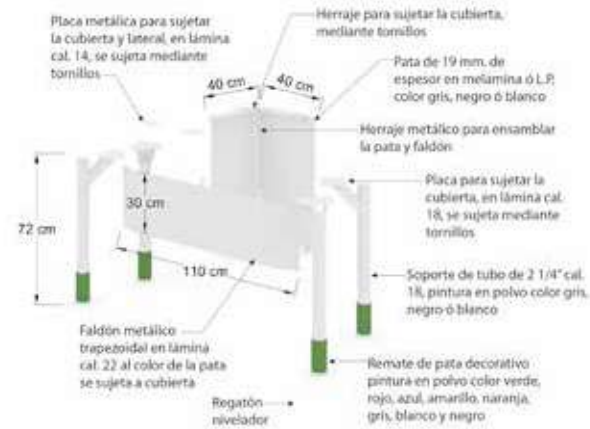

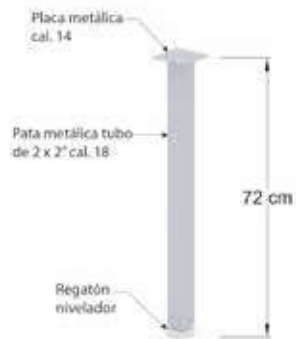
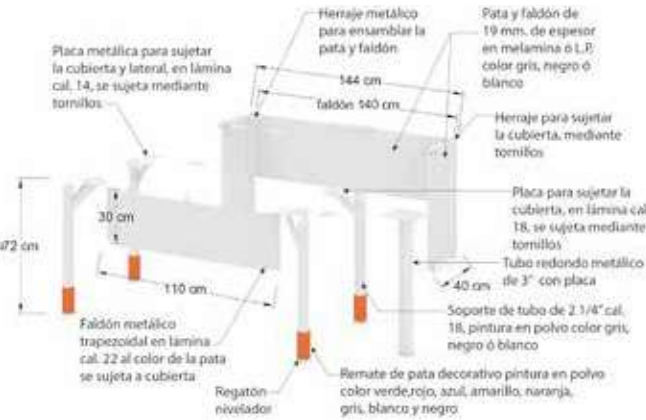











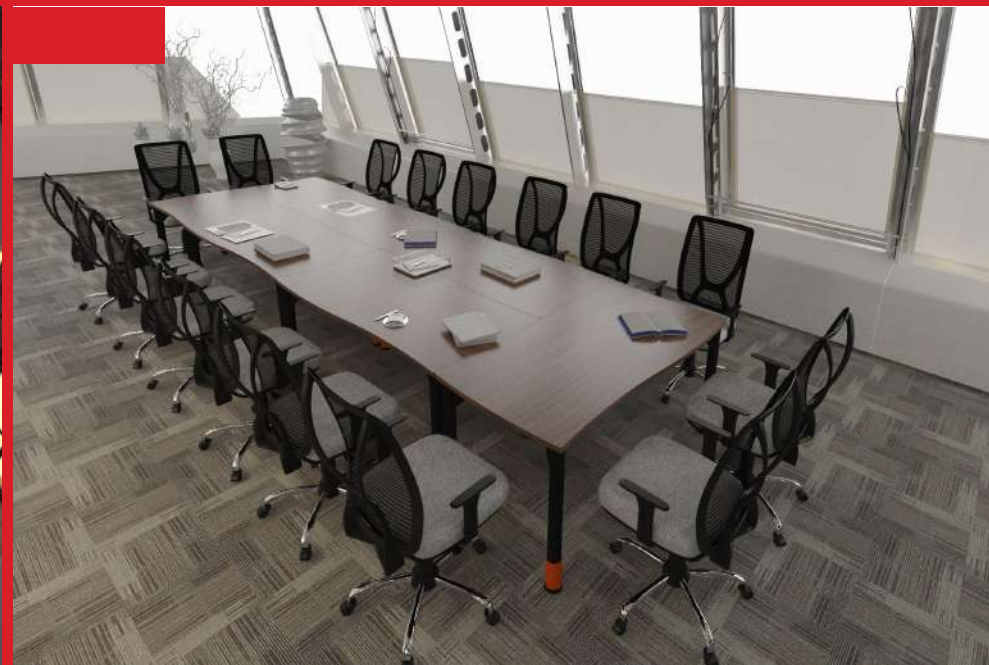

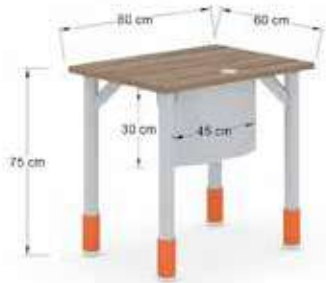

G08W



G13W



G15W

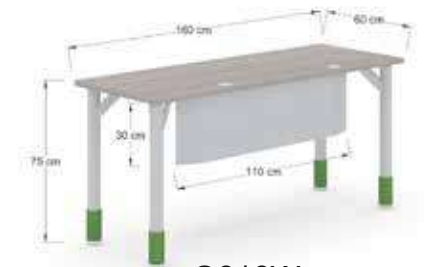

G616W



G618W



G816W



G818W



OPPGW16

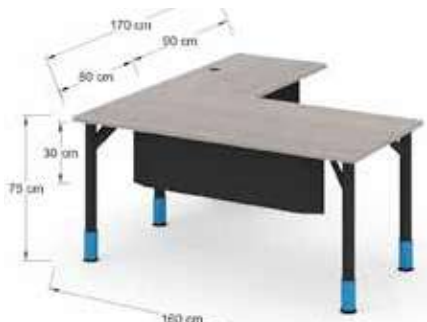

PORGW16



OPHGW16



ESPGW18



ESHGW18



G17W



G16W

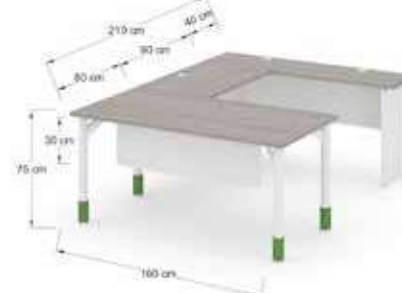

ESGGW16

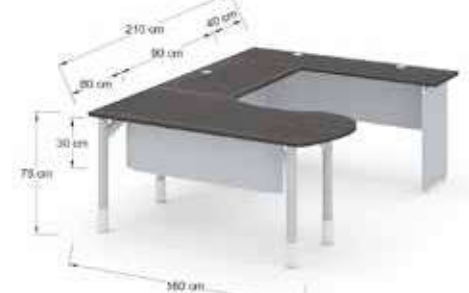

SEPGW16



SEHGW16

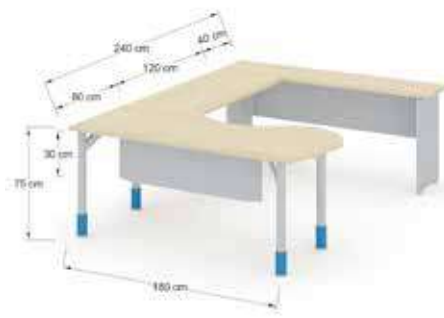

PDPGW18

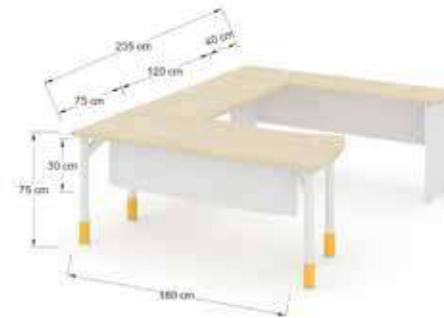

PDHGW18

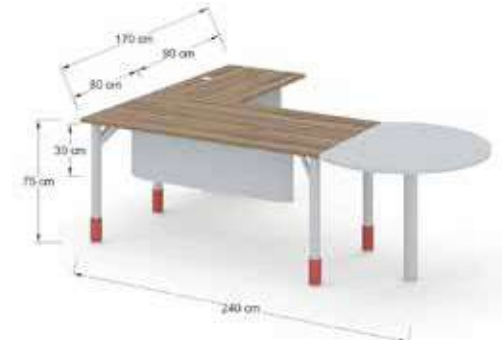

PEGGW24



PGDGW24



CCB06



CTB03

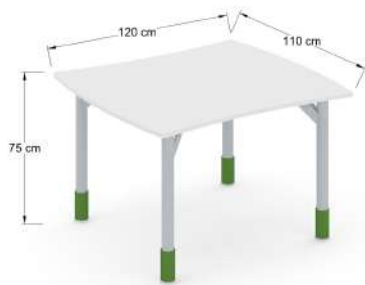

MJBEA12



MJBEA18

Línea Space Plus

Línea fabricadas en lámina calibre 18, se ensamblan mediante un tapa pierna de 30 cm de ancho, fabricado en lámina calibre 20 sujetando los extremos de ambas patas mediante tornillos e insertos colocados en los extremos de cada pata. Toda la estructura está pintada en color gris, negro o blanco.

a) cada pata tiene una puerta abatible para paso de cables en cada extremo desde el piso hasta la cubierta.

b) el cuerpo de las patas esta pintado en color negro, blanco o gris, la puerta abatible de la pata aasi como la base de la pata pueden ser pintads en colores, azul, rojo, narajna, amarillo, verde, gris, negro o blanco, para hacer su oficina direntente.

c) cubiertas fabricadas en laminado plastico (melamina) de 28 mm, colores de línea (chechar muestrario), con cantos de pvc al color de la cubierta, incluye insertos para su armado y grumet pasacables.

se pueden configurar multiples opciones ya que cuenta con diferentes modelos y medidas..

Las peninsulas independientes de la cubierta están soportados por una pata circular metálica de 5 cm de diámetro, pintada en color blanca gris ó negra.

Las mesas laterales ó terminales seconectan por médio de una placa en la cubierta y el otro extremo tiene una pata terminalde LP. de 19 mm, al color de la cubierta.

Puede llevar mini mampara adicional de laminado plástico ó melamina de 19 mm. al color del mueble ó en los colores de línea (ver muestrario), con los cantos de PVC al color de la cubierta, incluye adaptador para fijar al escritorio.

Nota: Estas mini mamparas y sus accesorios ijadores se venden por separado ya que no son parte integral del mueble.



Esta línea se puede surtir armada ó desarmada en caja, incluye empaque certificado, tornilleria necesaria para su ensamble y armado, asi como instructivo de armado.

Armada* Preguntar área de cobertura.

Desarmada** Preguntar área de cobertura, precio y cubicaje de cada modelo para su envio por letera ó revisar con costo adicional.

Especificación gráfica de chasis línea Moville Space Plus (SP15)



Especificación gráfica de cubierta línea Moville Space Plus (SP15)

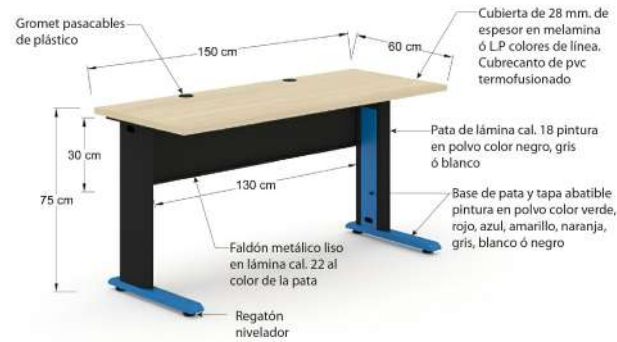

Especificación gráfica de chasis línea Moville Space Plus (ESPSS18)

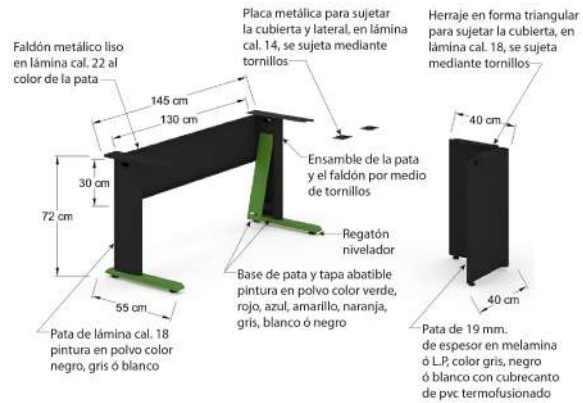

Especificación gráfica de cubierta línea Moville Space Plus (ESPSS18)



Especificación gráfica de chasis línea Moville Space Plus (PGDSS24)

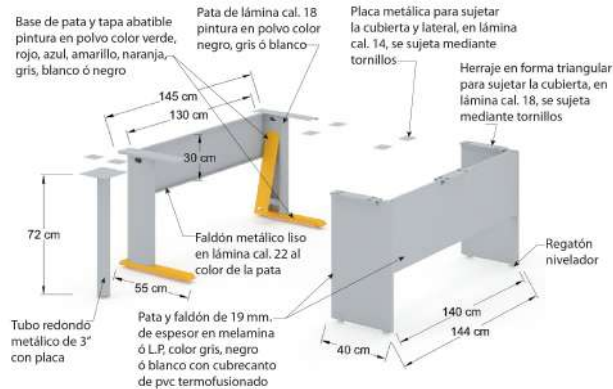

Especificación gráfica de cubierta línea Moville Space Plus (PGDSS24)













SP08

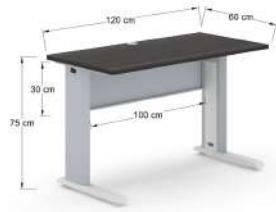

SP13



SP15



SP616



SP618



SP816



SP818



PORSS16



OPHSS16



ESHSS18



OPPSS16



ESPSS18



ESGSS16

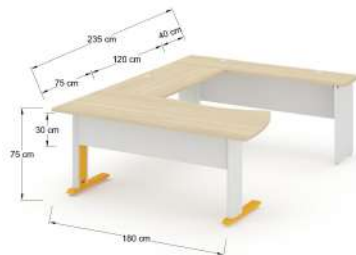

PDHSS18



SP16



SP17



SEHSS16

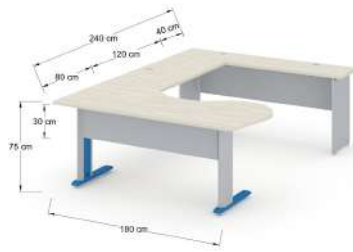

PDPSS18



SEPSS16

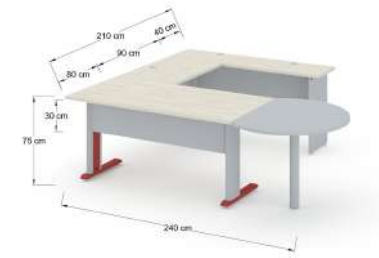

PGDSS24



PEGSS24



CCB06



CTB03



Esta línea se puede surtir armada ó desarmada en caja, incluye empaque certificado, tornillería necesaria para su ensamble y armado, así como instructivo de armado.

Armada* Preguntar área de cobertura.

Desarmada** Preguntar área de cobertura, precio y cubijaje de cada modelo para su envío por fletera ó revisar con costo adicional.

Línea Metra I:

Conjunto de escritorios, laterales, credenzas, mesas de trabajo con las siguientes especificaciones.

a) Cubiertas fabricadas en LP de 28 mm, colores de línea.

b) Tapa piernas fabricados en lámina calibre 22 al color de la estructura.

c) Patas y costados fabricados en tubo rectangular de dos pulgadas por una pulgada calibre 18 pintados en color negro, gris ó blanco. en forma de grapa.

d) Las penínsulas independientes de la cubierta están soportados por una pata circular metálica de 5 cm de diámetro, pintada en color blanca gris ó negra.

e) Las mesas laterales ó terminales se conectan por medio de una placa en la cubierta y el otro extremo tiene una pata terminalde LP.de 19 mm, al color de la cubierta.

Toda la línea se puede surtir desarmada ó en caja ya que su ensamble es muy sencillo, mediante tornillos.

Puede llevar mini mampara adicional de laminado plástico ó melamina de 19 mm. al color del mueble ó en los colores de línea (ver muestrario), con los cantos de PVC al color de la cubierta, incluye adaptador para fijar al escritorio.

Nota: Estas mini mamparas y sus accesorios fijadores se venden por separado ya que no son parte integral del mueble.

Especificación gráfica de chasis línea Movable operativa (PGD1MT24)

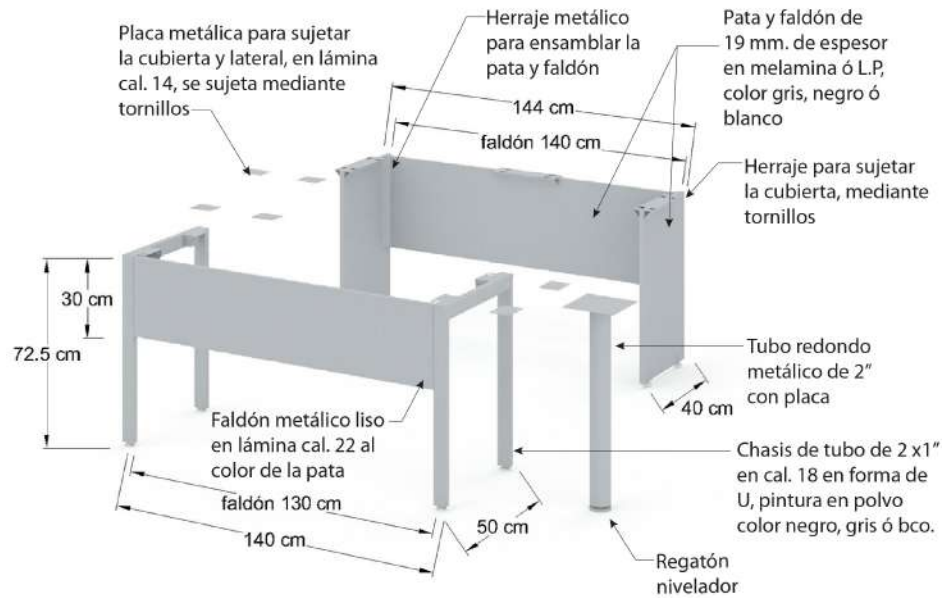

Especificación gráfica de cubierta línea Movable operativa (PGD1MT24)

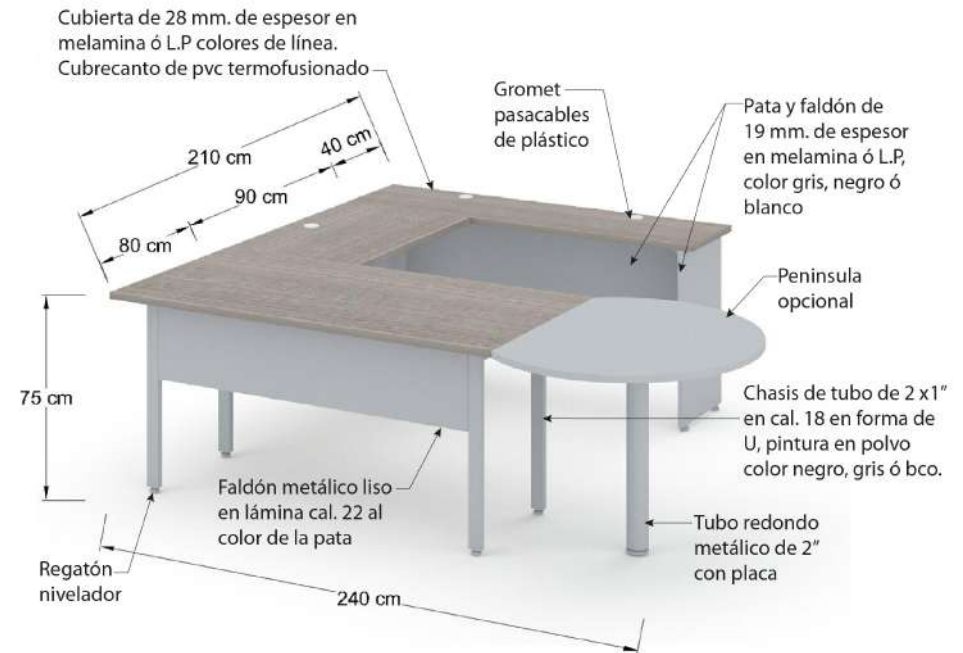











MT08



MT13



MT15



MT616



MT618



MT816



MT818



POR1MT16



OPH1MT16



ESH1MT18



OPP1MT16



ESP1MT18



ESG1MT16



PDH1MT18



MT16



MT17



SEH1MT16



PDP1MT18



SEP1MT16



PGD1MT24



PEG1MT24



CCB06



CTB03

**Línea Metra II:**

Conjunto de escritorios, laterales, credenzas, mesas de trabajo con las siguientes especificaciones.

- a) Cubiertas fabricadas en LP de 28mm, colores de línea.
- b) Tapa piernas fabricados en lámina calibre 22 al color de la estructura.
- c) Patas y costados fabricados en tubo rectangular de dos pulgadas por una pulgada calibre 18 pintados en color negro, gris ó blanco. en forma de marco.
- d) Las penínsulas independientes de la cubierta.
- e) Las mesas laterales ó terminales se conectan por medio de una pata termina de LP.de 19 mm, al color de la cubierta.

Toda la línea se puede surtir desarmada ó en caja ya que su ensamble es muy sencillo, mediante tornillos.

Puede llevar mini mampara adicional de laminado plástico ó melamina de 19mm. al color del mueble ó en los colores de línea (ver muestrario) con los cantos de PVC al color de la cubierta, incluye adaptador para fijar al escritorio.

Nota: Estas mini mamparas y sus accesorios fijadores se venden por separado ya que no son parte integral del mueble.

Esta línea se puede surtir armada ó desarmada en caja, incluye empaque certificado, tornillería necesaria para su ensamble y armado, así como instructivo de armado.

Armada* Preguntar área de cobertura.

Desarmada** Preguntar área de cobertura, precio y cubicaje de cada modelo para su envío por fletera ó revisar con costo adicional.

Especificación gráfica de chasis línea Movable operativa (PGDMT24)

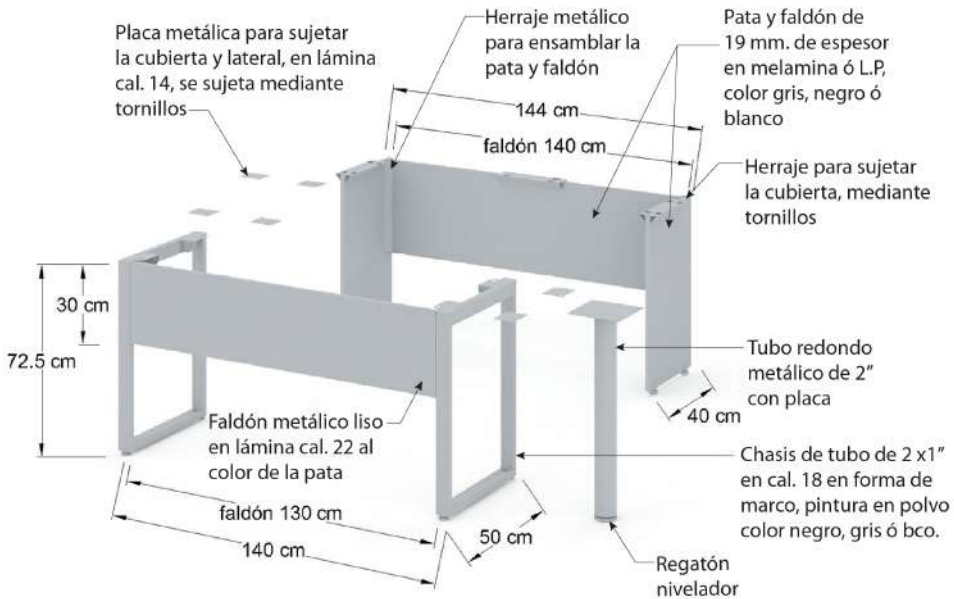

Especificación gráfica de cubierta línea Movable operativa (PGDMT24)

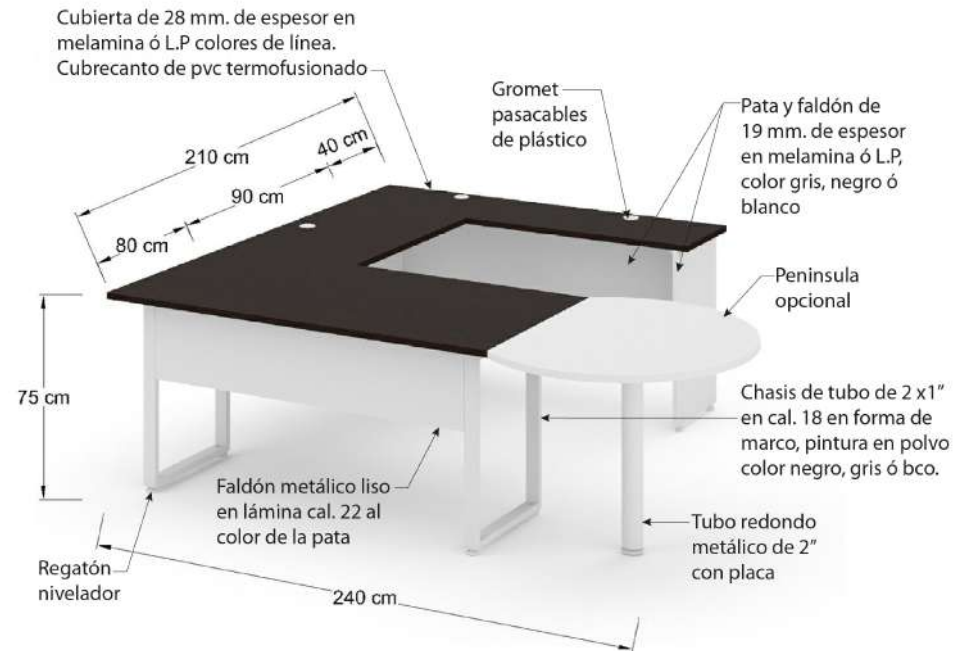











M08



M13



M15



M616



M618



M816



M818



ESP1MT18



PDHMT18



ESHMT18



OPPMT16



SEPMT16



PORMT16

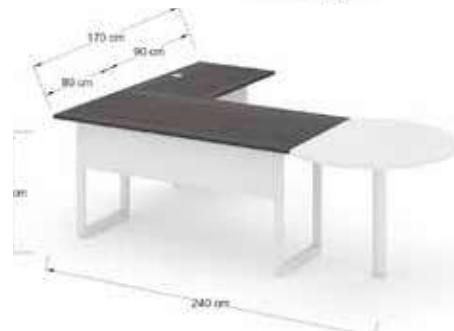

PEGMT24



M16



M17



SEHMT16



PDPMT18



PGDMT24



ESGMT16



CTB03



CCB06



Línea Qualium:

Conjunto de escritorios, laterales, credenzas , mesas de trabajo con las siguientes especificaciones.

a) Cubiertas curvas y semicurvas con esquinas redondeadas fabricadas en LP de 28 mm en colores de línea.

b) Costados fabricados en LP de 28 mm en color gris, blanco ó negro.

c) Tapa piernas fabricado en LP de 19 mm al mismo color que los costados. color gris, blanco ó negro.

Las penínsulas tienen como soporte una pata curva de tubo de 5 cm de diámetro con una base circular metálica.

Toda la línea se puede surtir desarmada ó en caja ya que su ensamble es muy sencillo, mediante tornillos.

* opcional

- cubiertas en chapa de encino.
- cubiertas en cristal de color, adherido a la cubierta.

nota: ninguna de estas opciones se puede surtir en caja.

Puede llevar mini mampara adicional de laminado plástico ó melamina de 19mm. al color del mueble ó en los colores de línea (ver muestrario) con los cantos de PVC al color de la cubierta, incluye adaptador para fijar al escritorio.

Nota: Estas mini mamparas y sus accesorios fijadores se venden por separado ya que no son parte integral del mueble.

Esta línea se puede surtir armada ó desarmada en caja, incluye empaque certificado, tornillería necesaria para su ensamble y armado, así como instructivo de armado.

Armada* Preguntar área de cobertura.

Desarmada** Preguntar área de cobertura, precio y cubijaje de cada modelo para su envío por fletera ó revisar con costo adicional.

Especificación gráfica de chasis línea Qualium (LPAQEJE1)

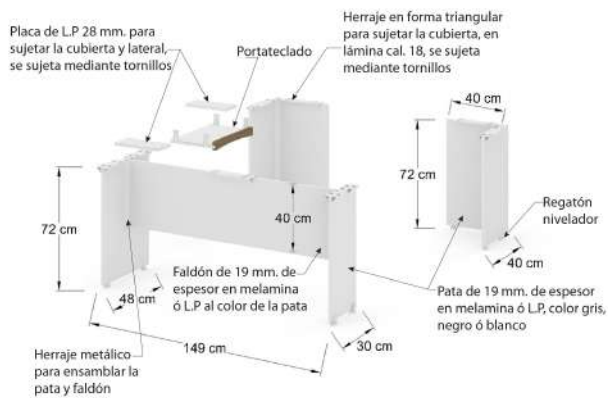

Especificación gráfica de cubierta línea Qualium Chapa (LPAQEJE1)

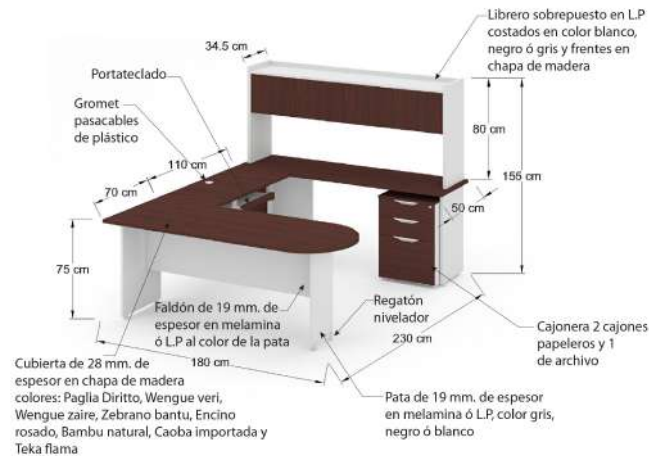

Especificación gráfica de cubierta línea Qualium (LPAQEJE1)



Especificación gráfica de chasis línea Qualium (PBQUA818)

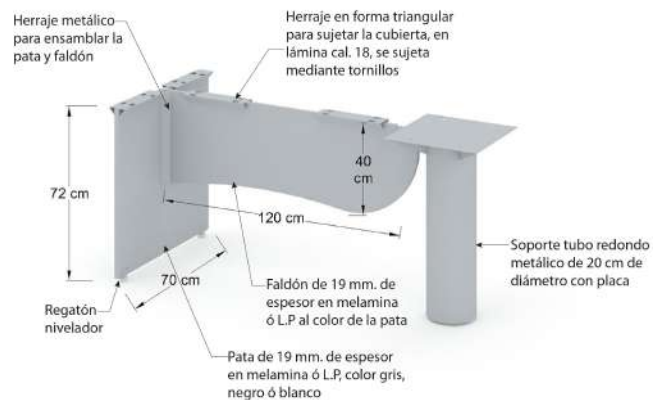

Especificación gráfica de cubierta línea Qualium chapa (PBQUA818)



Especificación gráfica de cubierta línea Qualium (PBQUA818)













CBQUA412



CBQUA415



CBQUA418



CBQUA419



CBQUA512



CBQUA515



CBQUA518



CBQUA519



CBQUA523



CBQUA612



CBQUA618



CBQUA619



CBQUA623



EQUA612



EQUA615



EQUA812



EQUA815



EQUA818



EQUA819



CBQUA419



PBQUA612



PBQUA615



PBQUA812



PBQUA815



PBQUA818



PBQUA819

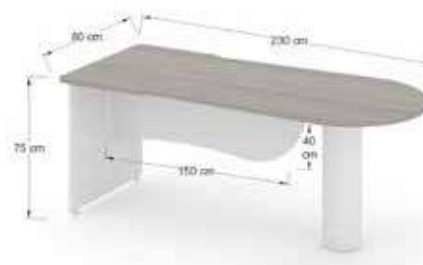

PBQUA823



PQMT12



PQMT14



PQPNB12



PQPNB14



PQMT15



PQMT18



PQMT19



PQQNB15



PQQNB18



PQQNB19



LPAQEJE1



LPAQEJE2



LPAQEJE3



LPAQEJE4



LPAQSEC2



LPAQSEC3



CUQUA480



CUQUA540



CUQUA680



CUQUA410



CUQUA510



CUQUA610



CTQUA480



CTQUA580



CTQUA680



CTQUA410



CTQUA510



CTQUA610



CBQUA412

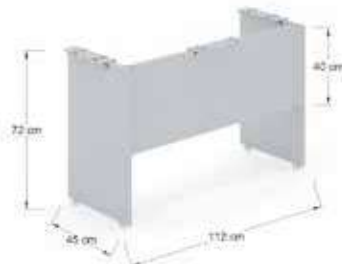

CBQUA512

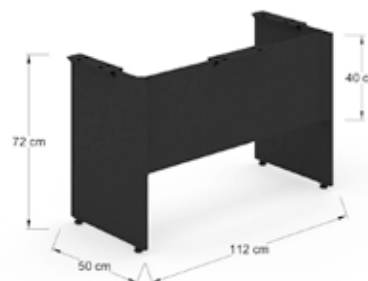

CBQUA612



CBQUA415



CBQUA515

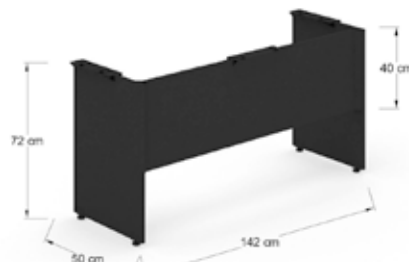

CBQUA615

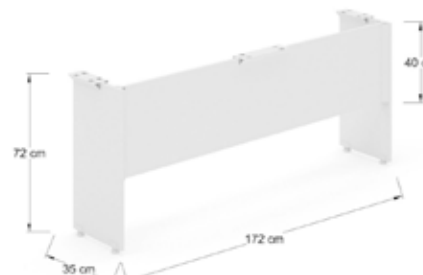

CBQUA418

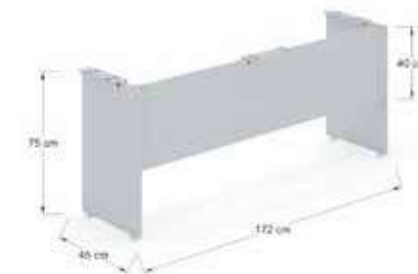

CBQUA518

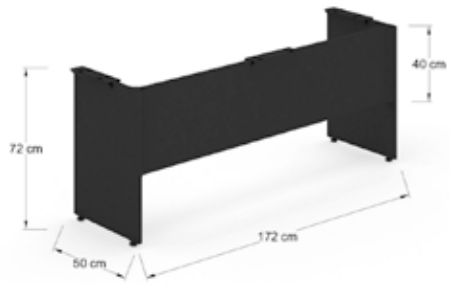

CBQUA618

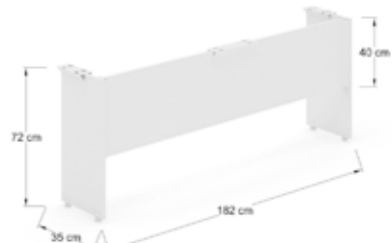

CBQUA419

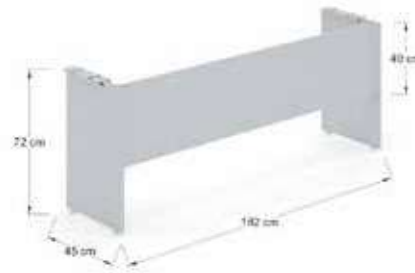

CBQUA519

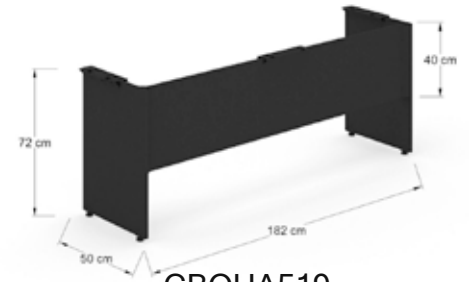

CBQUA519

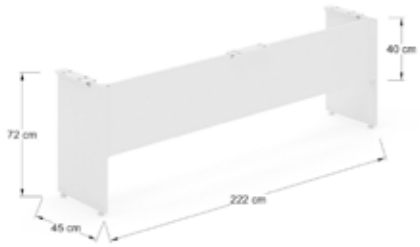

CBQUA519

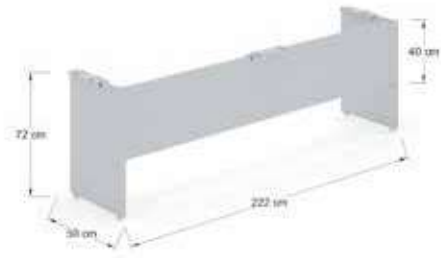

CTQUA623



woodsweb.com.mx

Sucursal del Valle :

Insurgentes Sur 590 B
Col: del Valle, C.P. 03100,
CDMX.
Tels: (55) 5682 4860,
(55) 5682 5936.

Sucursal Medellín :

Medellín 168. Col Roma,
C.P. 06760, CDMX.
Tels: (55) 5564 1461,
(55) 5564 1102.

Sucursal División del Norte :

División del Norte 606,
Col: del Valle, C.P. 03100,
CDMX.
Tels: (55) 5250 5417,
(55) 5250 6134.

Sucursal Santa Fe :

Av. Vasco de Quiroga No .
3800, Ctro. Com. Santa Fe
loc. 489, 1er nivel, CDMX.
Tels: (55) 5258 0845
(55) 2167 4278

muebles-oficina-express.com

sugerencias y cotizaciones : sugerencias@woodsweb.com.mx

Síguenos en
facebook



Woods Muebles Oficina,
Hogar y Restaurante