



Due to the high thrust motors that can be flown in this rocket, epoxy is recommended!

Before beginning construction, read over instructions to become familiar with the proper construction steps. Check Parts List to make sure you have all the parts.

TEST FIT ALL PARTS! Light sanding may be necessary to obtain proper fit.

ITEMS YOU WILL NEED TO BUILD THIS KIT

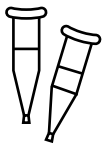

Glue
(Epoxy
Recommended)

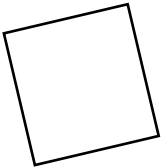

Sandpaper

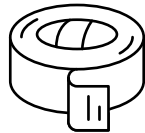

Masking Tape



Pencil and Ruler

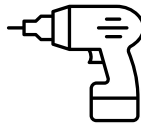

Drill



Paint

STEP 1 - Eye-bolt / Forward Centering Ring Assembly

Lightly sand outer glassine layer of motor tube until shiny surface is removed.

Mix a small amount of epoxy and spread onto the threads of the eye-bolt. Install one of the eye-bolt nuts onto the eye-bolt and thread all the way down to the eye. Slip one washer onto the eye-bolt, then insert into the **forward centering ring with laser drilled hole**. Slip the second washer onto the eye-bolt, followed by the remaining nut. Make sure the eye does not exceed the edge of the ring. A test fit into the booster will ensure proper position. Once the eye-bolt position is confirmed, spread the remaining epoxy over the upper and lower nuts and set aside to dry.

STEP 2 - Motor Tube / Centering Rings Assembly

Install the forward centering ring with the eye-bolt 1/4" from one end of the 11" length of the 38mm motor mount tube – this will be the FWD (Forward) end of the assembly.

Make sure the eye of the ring is forward!

Slide on another centering ring 5" from the other end of the motor tube, this is the MID (Middle) ring.

Slide last ring on and recess 1/4" as this is the AFT (Rear). You may check spacing by inserting a fin between MID and AFT rings. Make sure rings are perpendicular (at right angles) to the motor tube. **Test fit to ensure rings will not interfere with the fin slots!** Once you are sure of the ring placement, epoxy the rings onto the motor tube. Set aside to dry.



Test fit to ensure MID and AFT centering rings will not interfere with the fin slots!

Optional Pro Motor Retainer

LOC PRO Motor Retainers are CNC machined aluminum and anodized. Install onto aft of motor tube with JB Weld and easily flip motors in the field! [Click here for info!](#)

Parts List

Check your parts before you begin your build!

- Polyethylene Nose Cone
- Slotted Booster
- Payload Section
- 38MM Motor Tube
- 3/16" Tubular Nylon
- LP-28 Parachute
- Centering Rings (3)
- Starter Fire Blanket
- 1/4" Launch Lug/Rail Guides
- Laser Cut Fins (3)
- Vinyl Decal

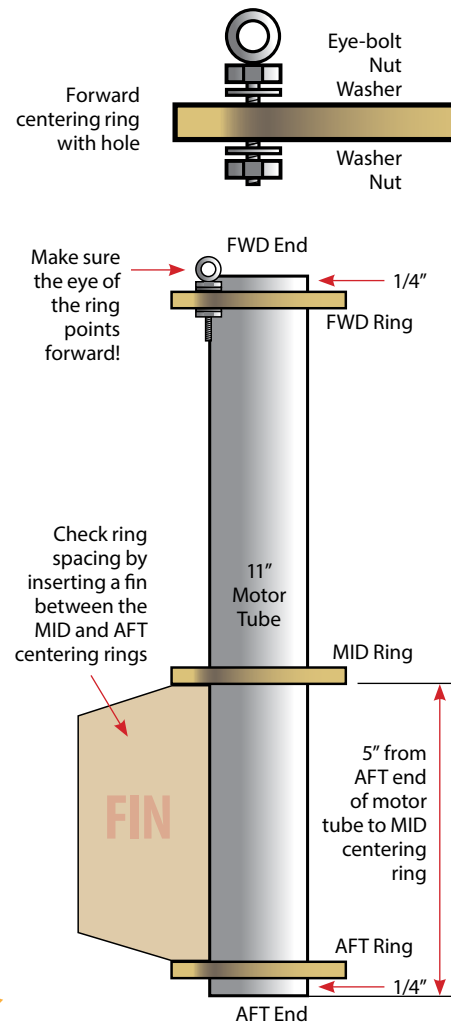

STEP 3 - Shock Cord / Eye-bolt Assembly

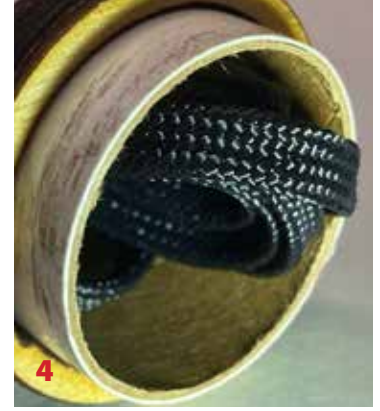

1. Take tubular nylon shock cord and insert one end into eye bolt.

2. Insert other end of shock cord through the sewn loop and ...

3. pull tight around eye bolt.

4. Bunch up shock cord and feed from FWD end of motor tube toward the AFT end of motor tube. This will keep it

clear of the epoxy through the following steps.

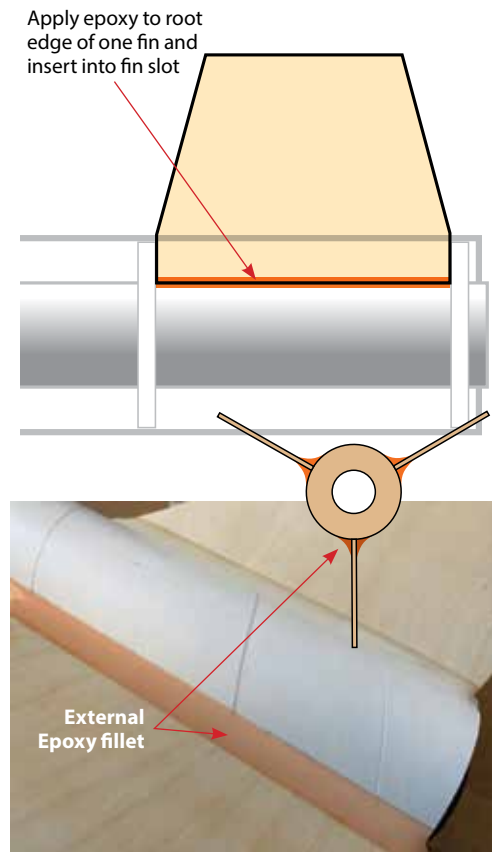
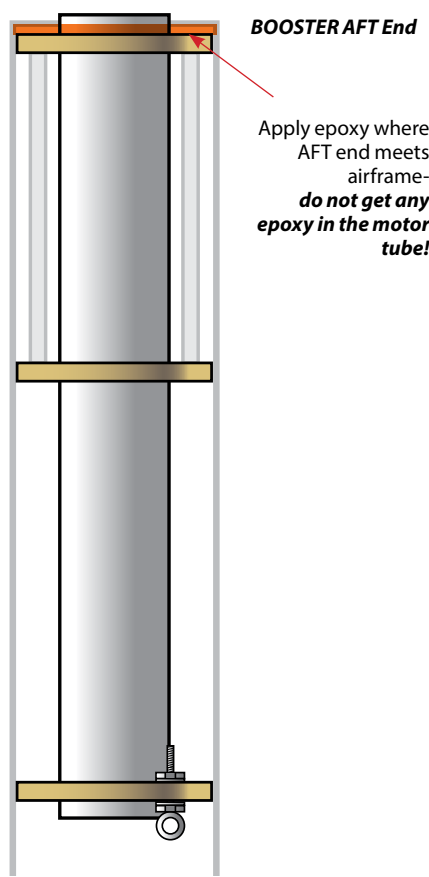
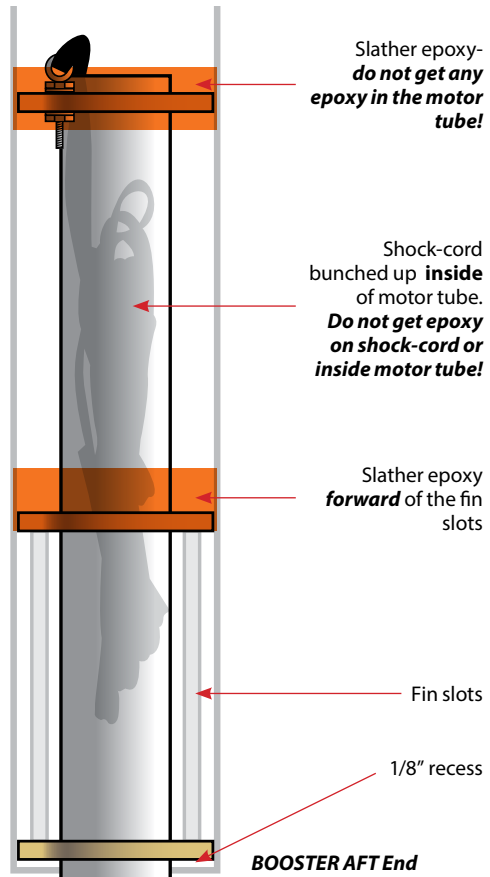

STEP 4A - Motor / Booster Airframe Assembly

Slather epoxy up the AFT of the booster tube (the end with fin slots) FWD of the fin slots. Insert motor mount assembly until AFT ring is 1/8" recessed. Stand airframe **AFT down** to cure. You may always add more epoxy to the FWD ring by drizzling epoxy onto the ring from the FWD end of the booster. **DO NOT get any epoxy in the motor tube!**

STEP 4B - Motor / Booster Airframe Assembly

Flip airframe over so **AFT is upright**. Apply an epoxy fillet to the intersection where the AFT ring meets the airframe. **DO NOT** get any epoxy in the motor tube! Allow to cure.

STEP 5 - Booster Airframe / Fin Assembly

Reposition airframe laying down. Apply a generous bead of epoxy to the root edge of one fin and insert in the fin slot. Allow to cure before moving onto the next fin. When all fins are epoxied in place, apply an external fillet to each fin to airframe joint.

STEP 6 - Bulkhead Assembly

Install screw eye in bulkhead. Epoxy both sides where the screw eye meets the bulkhead. Allow to cure.

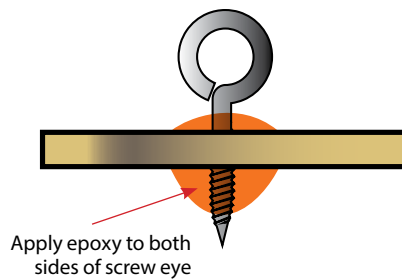

STEP 7 - Bulkhead / Coupler Assembly

Insert bulkhead into coupler. Epoxy fillet both sides where the bulkhead meets coupler. Allow to cure.

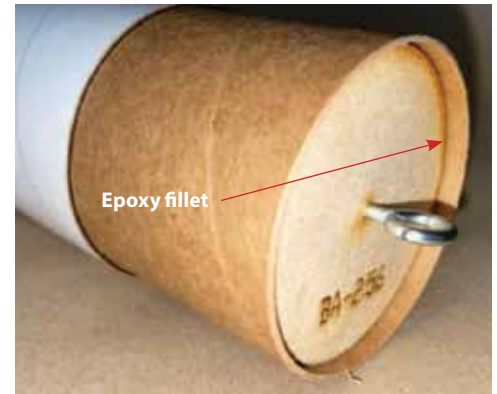
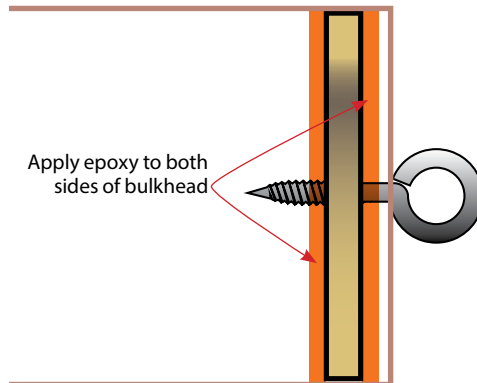

STEP 8 - Coupler / Payload Assembly

Slather epoxy in one end of payload section. Insert coupler 50% (3") in payload and allow to cure.

Optional Coupler Payload Assembly

You may retain the coupler with screws or plastic rivets. This will leave the possibility of adding an electronics bay in the future.

[Click for Nylon Rivets](#)

[Click for Electronic Bays](#)

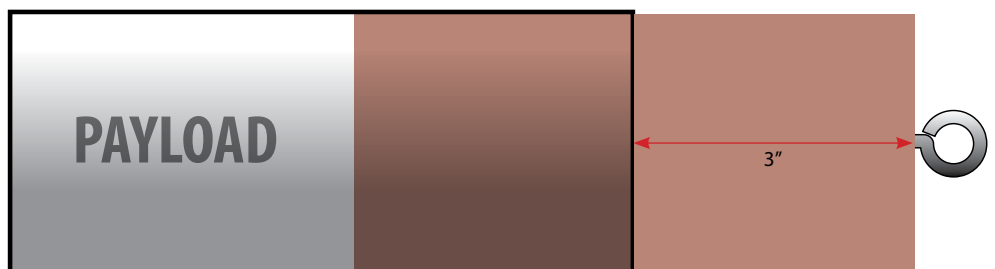

STEP 9 - Shock Cord Attachment

Shake or push shock cord from motor tube out the FWD end of booster.

Insert shock cord into fire resistant blanket and slide down.

Insert shock cord 3' through screw eye. Make a knot.

At the end of the shock cord, insert parachute shroud lines. Then pass parachute canopy back through shroud line loops, pull tight.



Screw eye knot



Parachute / Shock Cord knot

STEP 10 - Nose Cone Assembly

Friction fit the nose cone to FWD end of payload using masking tape. You may also use plastic push rivets or screws.

Make sure the cone will NOT come off during ejection or decent.

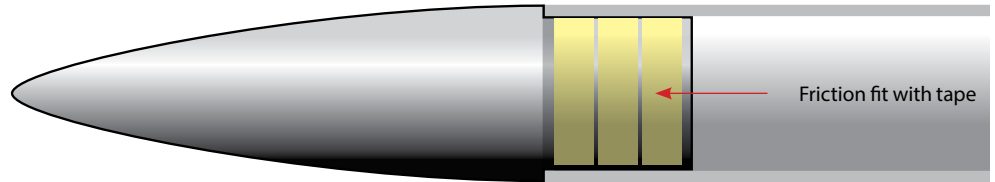

STEP 11 - Rail Guides / Launch Lugs

Install the rail guides into the booster with provided screws:

- Drill a hole smaller than the screw so the screw threads into it 1/2" forward of aft ring centered between fin set
- Drop a small amount of epoxy in drilled hole
- Thread the rail guide and screw in the hole
- Rotate rocket 180 degrees and let cure
- Repeat for the forward rail guide 1/2" aft of the forward ring

Optional Install:

Some choose to use a wood screw drill/tighten into the aft and forward rings. Your choice!

Note: Launch lugs provided if launched from a rod



STEP 12 - Paint / Finish

- Spray rocket with primer, sand and repeat until smooth finish is obtained
- Spray rocket with paint of choice, let dry.
- Apply protective clear coat
- Apply vinyl decals to your liking
- Repeat with clear coat.

PREFLIGHT

Sim Your Rocket!

This rocket is recommended for high power rocket motors F through H impulse. Depending on your flying field and finished weight, this is a very versatile kit. The Rocksim® file is available on the 2.6" HI-TECH product page on our website.

Always check stability to ensure stable flight; the Center of Gravity (CG) must be forward of the Center of Pressure (CP) in flight ready condition.



Hi-Tech Specs

Height: 49.75"

Weight: 20 oz.*

Diameter: 2.630"

* Be sure to weigh your rocket!

Your build may be above or below the specified weight. The actual weight must be entered into the sim software to get correct flight statistics.

Motor Suggestions

F50-6*

F55-6*

G40-7*

G80-7*

H97-10*

H128-M*

H45-10

H123-M

*29mm motors to be used with 29mm MMA-2 Motor Adapter



Since Yank Aeronautics LLC dba LOC PRECISION cannot control the use of its products once sold, the buyer assumes all risks and liabilities there from, and accepts and uses LOC Precision products on these conditions. For any questions or issues please contact LOC directly—info@locprecision.com

© YANK AERONAUTICS LLC. dba LOC PRECISION ALL RIGHTS RESERVED



Model Rocket Safety Code

Materials – I will use only lightweight, non-metal parts for the nose, body, and fins of my rocket.

Motors – I will use only certified, commercially made model rocket motors, and will not tamper with these motors or use them for any purposes except those recommended by the manufacturer.

Ignition System – I will launch my rockets with an electrical launch system and electrical motor igniters. My launch system will have a safety interlock in series with the launch switch, and will use a launch switch that returns to the “off” position when released.

Misfires – If my rocket does not launch when I press the button of my electrical launch system, I will remove the launcher’s safety interlock or disconnect its battery, and will wait 60 seconds after the last launch attempt before allowing anyone to approach the rocket.

Launch Safety – I will use a countdown before launch, and will ensure that everyone is paying attention and is a safe distance of at least 15 feet away when I launch rockets with D motors or smaller, and 30 feet when I launch larger rockets. If I am uncertain about the safety or stability of an untested rocket, I will check the stability before flight and will fly it only after warning spectators and clearing them away to a safe distance. When conducting a simultaneous launch of more than ten rockets, I will observe a safe distance of 1.5 times the maximum expected altitude of any launched rocket.

Launcher – I will launch my rocket from a launch rod, tower, or rail that is pointed to within 30 degrees of the vertical to ensure that the rocket flies nearly straight up, and I will use a blast deflector to prevent the motor’s exhaust from hitting the ground. To prevent accidental eye injury, I will place launchers so that the end of the launch rod is above eye level or will cap the end of the rod when it is not in use.

Size – My model rocket will not weigh more than 1,500 grams (53 ounces) at liftoff and will not contain more than 125 grams (4.4 ounces) of propellant or 320 N-sec (71.9 pound-seconds) of total impulse.

Flight Safety – I will not launch my rocket at targets, into clouds, or near airplanes, and will not put any flammable or explosive payload in my rocket.

Launch Site – I will launch my rocket outdoors, in an open area at least as large as shown in the accompanying table, and in safe weather conditions with wind speeds no greater than 20 miles per hour. I will ensure that there is no dry grass close to the launch pad, and that the launch site does not present risk of grass fires.

Recovery System – I will use a recovery system such as a streamer or parachute in my rocket so that it returns safely and undamaged and can be flown again, and I will use only flame-resistant or fireproof recovery system wadding in my rocket.

Recovery Safety – I will not attempt to recover my rocket from power lines, tall trees, or other dangerous places.

Launch Site Dimensions

Installed Total Impulse (N-sec)	Equivalent Motor Type	Minimum Site Dimensions (Ft.)
0.00 – 1.25	1/4A, 1/2A	50'
1.26 – 2.50	A	100'
2.51 – 5.00	B	200'
5.01 – 10.00	C	400'
10.01 – 20.00	D	500'
20.01 – 40.00	E	1,000'
40.01 – 80.00	F	1,000'
80.01 – 160.00	G	1,000'
160.01 – 320.00	Two G's	1,500'

Schools, Clubs and Other Groups

Loc Precision Multi-Packs are available for this and other Loc Precision Rocket kits. Call or email us for multi-pack pricing.

