

# FarmLife™

WWW.FARMLIFE.SHOP



# farmlife.shop

6 Helmsmore Lane Quail Rise QUEENSTOWN 9371  
DDI: 0800 10 24 10 | Mob: 0274 941 245

7	Aluminium Composite Panel (Dibond) Signs
8	Backlit Poster Frames
7	Bollard Covers
15	Bunting
10	Cafe Barriers
10	Cafe Umbrellas
12	Car Flags
7	Corflute Signs
21	Exhibition Booths
23	Fabric Covered Tables
11	Flag Pole Flags
17	Floor Stickers
12	Hand Wave Flags
23	Inflatables
14	Marquees
18	Media Walls
9	Mesh Polyester Banners
12	Music Stand Covers
13	Pennants
20	Polyester Sleeve Floor Displays
16	Pop Up Banners
15	Pull Out Banners
5	Pull Up Banners (Light Weight and Premium)
11	Shop Front Flags
9	Snap Lock Picture Frames
8	Stackable Cubes & Triangles (Corflute)
19	Stretch Fabric Displays
22	Table Covers
6	Table Top Banners
2	Tear Drop and Wing Banners
4	Tear Drop and Wing Banner Bases / Accessories
13	Vinyl Mesh and Vinyl Banners

## Tear Drop Banner

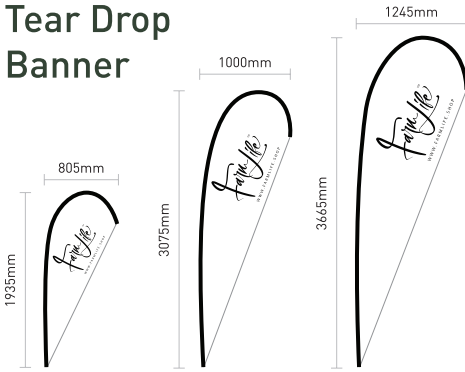

## Wing Banner Shape 1

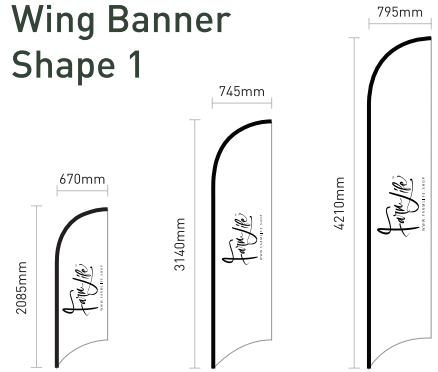

## Wing Banner Shape 2

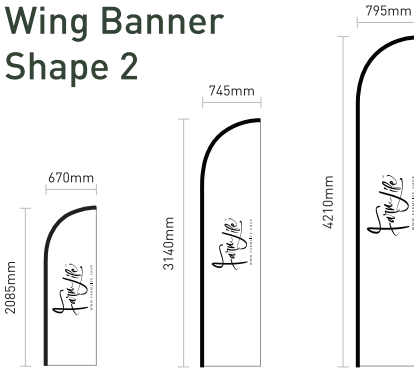

## Wing Banner Shape 3

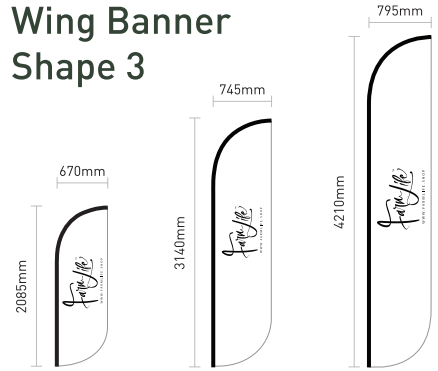

## Wing Banner Shape 4

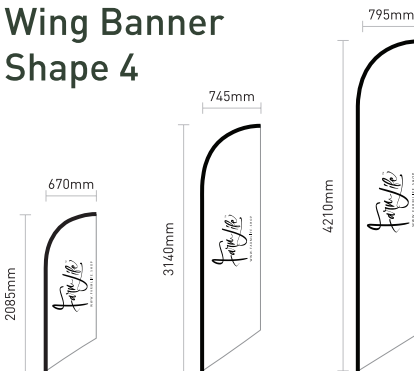

## Wing Banner Shape 5

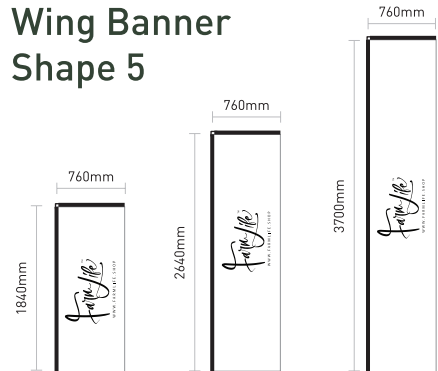

- Total set up height from ground dependent on pole size and base type
- Banners are supplied in an Oxford carry case and include pole kit and selected base type
- Banner sleeve pockets are black (or white if requested).





## **Tear Drop and Wing Banners**

### **Supplied with base of choice**

- Banner shapes and sizes are on page 2
- Banners are supplied with an Oxford carry case and base of choice
- Banner poles are fibreglass
- Banners are printed UV resistant full colour dye sublimation, banner sleeve pockets are black (or white if requested)
- Single sided banners are printed on 110gsm knitted polyester
- Double sided banners are printed on 2 pieces of 110gsm knitted polyester with a UV block-out sheet in-between to prevent the image on the other side of the banner showing through
- Standard lead time 10 - 15 days from artwork approval for orders up to 19 banners. Please contact us for lead time for orders of 20 or more banners

# Bases / Accessories



Water Bag  
(optional extra)

## Retractable Cross Base

- Weight - 3kg
- Chrome plated
- Great for installing wing and tear drop banners indoors or outdoors with a water bag



## Water Base

- Weight - approx. 18kg when filled
- Available in black only
- Perfect for installing wing and tear drop banners in windy areas



## Marquee Water Base

- Weight - approx. 9kg when filled



## Screw In Base / Spiky Base

- Light weight
- Excellent for installing wing and tear drop banners on lawn or other soft surfaces. Screw In Base can be left in ground permanently

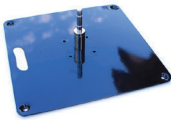

Water Bag  
(optional extra)

## Flat Metal Base

- Weight - 5kg
- Black powder coat with chrome spindle
- Great for installing wing and tear drop banners indoors or outdoors with a water bag



## Wall / Ground Mount Brackets

- Allows the banner to be installed off of the ground for increased height and visibility
- Available in 25 and 180 degree and ground mount bracket
- For use with SMALL and MEDIUM banners only



Water Bag  
(optional extra)

- Great for use with flat metal base or cross base in windy areas

Diameter of spindle on all bases is 15mm

# Pull Up Banners

- Ideal for trade shows, showrooms, reception areas, displays, conferences, presentations etc.
- Quick set up and compact storage
- Light Weight Pull Up Banner supplied with silver aluminium base with fold out feet (approx. 3kg)
- Premium Pull Up Banner supplied with streamline weighted base (approx. 6kg)
- Full colour digital print on curl resistant Rite-Flat blockout media
- Supplied with padded carry bag
- Please contact us for lead times



Light Weight Pull Up Banner



Premium Pull Up Banner

- Size options:
  - 600mm x 1600mm (available in Light Weight & Premium - single sided only)
  - 850mm x 2000mm (available in Light Weight single or double sided & Premium, single sided only for small quantities)
  - 1000mm x 2200mm (available in Light Weight & Premium, single sided only for small quantities)

## Table Top Pull Up Banners

- MOQ of 10 applies
- Silver aluminium light weight base available in A3 & A4
- Full colour single or double sided digital print on curl resistant polypropylene
- Ideal for trade shows, presentations, displays, conferences, etc.
- Standard lead time for quantities up to 14 is 5 – 7 days from artwork approval. Please contact us for lead time for orders of 15 or more



## Table Top Tear Drop Banners

- MOQ of 10 applies
- Full colour dye sublimation print on 110gsm knitted polyester
- 580mm tall, weight 0.3kg
- Single sided only (reverse image on back)
- Print can be different on each banner eg. different numbers for table settings
- Supplied with fibreglass pole and metal base
- Replacement skins available
- Standard lead time 10 - 15 days from artwork approval



# Aluminium Composite Panel (Dibond) Signs

- MOQ and size restrictions apply
- Very durable - 3mm thickness
- Full colour SAV digital print, single or double sided
- Suitable for indoor or outdoor use
- Custom sizes available
- Standard lead time for quantities up to 4 is 5 - 7 days from artwork approval. Please contact us for lead time for orders of 5 or more



# Corflute Signs

- MOQ and size restrictions apply
- 3mm or 5mm thickness
- Full colour SAV digital print, single or double sided
- Suitable for indoor or outdoor use
- Custom sizes available
- Standard lead time for quantities up to 4 is 5 - 7 days from artwork approval. Please contact us for lead time for orders of 5 or more



# Bollard Covers (Corflute)

- MOQ of 10 applies
- Full colour digital print on SAV
- Bollard cover size 270mm x 1000mm x 3mm corflute
- Standard lead time for quantities up to 14 is 5 - 7 days from artwork approval. Please contact us for lead time for orders of 15 or more





# Stackable Cubes & Triangles (Corflute)

CUSTOM  
SIZES  
AVAILABLE



- MOQ of 10 applies
- Great for trade shows, presentations, product launches, displays, shop windows, shopping malls etc.
- Full colour digital print on SAV
- Standard sizes:
  - 300mm x 300mm
  - 400mm x 400mm
  - 500mm x 500mm
  - Custom sizes available
- Standard lead time for quantities up to 4 is 5 – 7 days from artwork approval. Please contact us for lead time for orders of 5 or more

# Backlit Poster Frames



- MOQ of 3 applies
- Great for trade shows, presentations, displays, shop windows, shopping malls etc.
- Full colour digital print on 200gsm backlit film
- Portrait or landscape orientation options
- Detachable and adjustable legs
- Acrylic front - clear
- Light weight unit, 10mm thick
- Size options:
  - A4 (0.6kg)
  - A3 (1kg)
- Supplied with transformer
- Standard lead time for quantities up to 9 is 5 - 7 days from artwork approval. Please contact us for lead time for orders of 10 or more

# Mesh Polyester Banners

- Full colour dye sublimation digital print
- 130gsm polyester mesh fabric
- Banners are supplied with reinforced edges and eyelets every 1000mm
- Standard lead time 10 - 15 days from artwork approval

CUSTOM  
SIZES  
AVAILABLE



Any Size  
Banner  
Available

# Snap Lock Picture Frames

- MOQ of 10 applies
- Size options:
  - A4 print size
  - A3 print size
- 25mm rounded snap lock frame
- Supplied with full colour digital print (can supply frame only or print only)
- Replacement prints available
- Standard lead time for quantities up to 14 is 5 - 7 days from artwork approval. Please contact us for lead time for orders of 15 or more



# Café Barriers



- Great for use in café/restaurant alfresco areas or for other barrier uses
- Frame is supplied flat packed and simply clicks together
- Light weight aluminium tube frame with feet (43mm diameter frame)
- Full colour double sided dye sublimation on 230gsm polyester
- Size options:
  - 1040mm x 915mm (graphic area 900mm x 710mm, plus 65mm black outer sleeve)
  - 2040mm x 915mm (graphic area 1900mm x 710mm, plus 65mm black outer sleeve)
- Standard lead time 10 – 15 days from artwork approval

# Café Umbrellas

- Umbrella supplied with aluminium frame (47mm diameter pole) and printed canopy (base not included)
- Canopy is 500D Oxford fabric which is waterproof, PU coated and flame retardant
- 2m x 2m canopy available with or without a valance
- Full colour dye sublimation
- Standard lead time 10 – 15 days from artwork approval



# Flag Pole Flags

- Flags include sister clips for easy installation - optional fittings available
- Flags are dye sublimated on 110gsm knitted polyester (approx. 90% bleed through) or 130gsm trilobal polyester (approx. 75% bleed through) with double stitched edges
- Standard sizes:
  - 1800mm x 900mm
  - 2500mm x 1250mm
  - Custom sizes available
- Double sided flags available
- 500D woven polyester available for extra durability and longer life
- Standard lead time 10 - 15 days from artwork approval for orders up to 49 flags. Please contact us for lead time for orders of 50 or more flags

**CUSTOM SIZES AVAILABLE**



Sister Clip

# Shop Front Flags

- MOQ of 5 applies
- Full colour digital print on 400gsm double sided vinyl or 500D double sided Oxford fabric
- Flag size 400mm x 600mm
- Supplied with removable plastic pole and 4 way bracket to allow set up at various angles
- Standard lead time 10 - 15 days from artwork approval



# Hand Wave Flags

- Standard flag size:
  - 300mm x 200mm
  - Custom sizes available
- Available in:
  - PVC : Double sided print on 0.2mm PVC
  - Polyester : Single sided print (100D polyester with approx. 85% bleed through)
  - Paper : Single or double sided print on coated paper
  - PPE Clear Plastic : Single sided print (with bleed through)
- Supplied with plastic pole
- Please contact us for lead times



# Car Flags

- Flag size is 450mm x 300mm
- Full colour single sided digital print on 110gsm knitted polyester
- Supplied with plastic pole and car window clip
- Please contact us for lead times



# Music Stand Covers

- Standard size:
  - 540mm wide x 530mm high, plus 200mm sleeve to slide over music stand
  - Custom sizes available
- Full colour digital print on 160gsm satin drill
- Standard lead time 10 – 15 days from artwork approval



# Pennants

- Standard size:
  - 210mm x 300mm with 20mm tassels
  - Custom sizes available
- Full colour digital print on 160gsm satin drill
- Includes 360mm cord on 235mm wide pole
- Standard lead time 10 – 15 days from artwork approval



# Vinyl Mesh and Vinyl Banners

- MOQ and size restrictions apply
- Full colour CMYK digital print
- Single sided and double sided vinyl banners printed on outdoor quality vinyl (single sided only for vinyl mesh)
- Banners are supplied with welded edges and eyelets every 1000mm
- Please contact us for lead times



# Marquees

- Supplied with 40mm aluminium frame, printed canopy, ropes, pegs and wheel bag
- Canopy is 500D Oxford fabric which is waterproof, PU coated and flame retardant
- Single sided or double sided full walls available for all sizes (half walls available for 3 metre sides only)
- Single sided walls available with window
- Clear protective screen walls available for 3 metre sides
- Full colour dye sublimation
- Size options:
  - 3m x 3m
  - 6m x 3m
- Replacement ropes and pegs available
- Frames and printed or unprinted walls and canopies available individually\*
- Sea freight available for orders of 10 + marquees
- Please contact us for lead times

## Marquee Extras

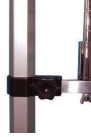

**Bracket for Wing / Tear Drop Banner**



**Gutter Kit**  
Gutter kit required when joining 2 marquees



**Sand Bag**



**Marquee Water Base**

- Weight - approx. 9kg when filled



\*Un-printed stock walls and canopies available in black, red, yellow, green and white

# Bunting

- Vinyl or polyester - single sided or double sided
- 30 flags per 10 metres as a standard - customisation available
- Standard sizes:
  - Triangle flags, 150mm x 200mm
  - Rectangle flags, 150mm x 200mm
  - Custom sizes available
- PVC also available - minimum order 2000 metres
- Please contact us for lead times

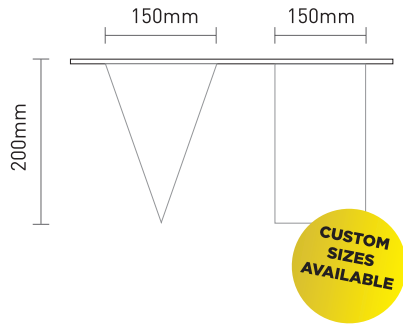

# Pull Out Banners

- Size of opened banner is 700mm x 240mm
- Double sided or single sided print available
- Offset gravure print
- Please contact us for lead times





# Pop Up Banners

## Round Pop Up Banners

- Full colour dye sublimation print on 240gsm knitted polyester
- Double sided
- Supplied with steel wire frame and carry case
- Size options:
  - 1200mm diameter
  - 1400mm diameter
- Standard lead time 10 - 15 days from artwork approval for orders up to 24 banners. Please contact us for lead time for orders of 25 or more banners



## Vertical Pop Up Banners

- Full colour dye sublimation print on 240gsm knitted polyester
- Double sided
- Target hole can be added
- Supplied with steel wire frame and carry case
- Size options:
  - 920mm x 1100mm
  - 1050mm x 1250mm
- Standard lead time 10 - 15 days from artwork approval for orders up to 24 banners. Please contact us for lead time for orders of 25 or more banners

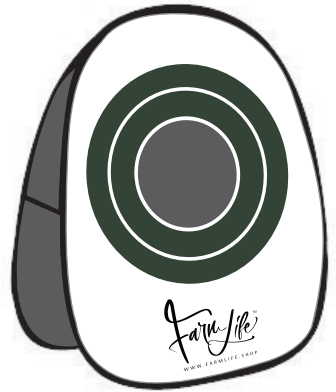

## Horizontal Pop Up Banners

- Full colour dye sublimation print on 240gsm knitted polyester
- Double sided
- Supplied with steel wire frame and carry case
- Size options:
  - 1300mm x 660mm
  - 1600mm x 650mm
  - 2000mm x 1000mm
- Standard lead time 10 - 15 days from artwork approval for orders up to 24 banners. Please contact us for lead time for orders of 25 or more banners



# Floor Stickers

- MOQ applies
- Floor stickers are a perfect advertising medium for floors, walls and footpaths
- Premium quality, offering long durability due to the composition of PVC and fabric
- Embossed textured matte finish to prevent slippage - R11 slip rating (Slip Resistance Test AS 4586:2031)
- Lifespan of the stickers is dependent on the movement at the place of installation, however, is estimated to be approximately 9 to 12 months in normal operation
- Full colour digital print and cut to custom sizes
- Stickers can be removed without leaving residue behind
- Standard lead time 5 – 7 days from artwork approval



# Media Walls

- Great for trade shows, exhibitions, presentations, green screens, etc.
- Dye sublimation print on high quality 250gsm knitted polyester
- Wrap around printed sides available
- Graphics are attached to the aluminium concertina style frame with Velcro
- Size options:
  - 2250mm x 2250mm (flat or curved wall)
  - 3000mm x 2250mm (flat or curved wall)
- Set up and pull down in minutes
- Total weight of frame and print approx. 10kg
- Supplied with carry bag
- Sea freight available for orders of more than 20 units
- Standard lead time 10 - 15 days from artwork approval

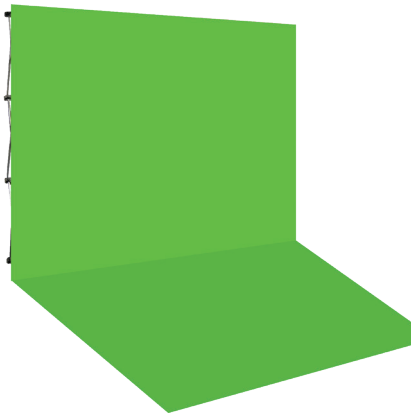

# Stretch Fabric Displays



Straight shape



Snake shape



\* All stretch displays supplied with carry bag



H-shape (flat, angled or curved top)

- Great for trade shows, presentations, displays, back drops etc.
- Light weight aluminium frame and feet (tube frame 1mm thick and 32mm diameter)
- Frame clicks together for quick and easy assembly and dismantle
- Full colour double sided dye sublimation print on 240gsm stretch polyester sleeve (Snake shape display available as single sided print only)
- Size and shape options:
  - Straight shape (2950mm x 2210mm)
  - H-shape (flat, angled or curved top, 1000mm x 2500mm)
  - Snake shape (single sided print only 915mm x 2280mm)
- Supplied with carry bag
- Standard lead time 10 – 15 days from artwork approval

# Polyester Sleeve Floor Displays



- Great for trade shows, presentations, back drops etc.
- Light weight aluminium frame with plastic foldable feet (suitable for indoor use)
- Frame clicks together for quick and easy assembly and dismantle
- Full colour double sided polyester pillow case style sleeve slides over frame
- Size options:
  - 1000mm x 2300mm
  - 1200mm x 2300mm
  - 2400mm x 2300mm
- Supplied with carry bag
- Standard lead time is 10 – 15 days from artwork approval

# Exhibition Booths

## Portable Trade Show Exhibition Booths

- Great for trade shows, presentations, product launches, back drops etc.
- Light weight aluminium frame and feet (tube frame 1mm thick and 32mm diameter)
- Frame clicks together for quick and easy assembly and dismantle
- Full colour double sided dye sublimation print on 240gsm stretch polyester sleeve
- Various size and shape options available
- Optional accessories available (LED lights, TV stand, S-connect joiner, leg inserts / joiners and table stand)
- Supplied with carry bag
- Standard lead time 10 – 15 days from artwork approval



### Exhibition Booth A Includes:

- 1 x 3m stretch fabric display
- 1 x 1m stretch fabric display (flat, angled or curved top)
- 1 x 800mm x 500mm x 1000mm fabric covered table
- 1 x leg connector



### Exhibition Booth B Includes:

- 1 x 3m stretch fabric display
- 2 x 1m stretch fabric displays (flat, angled or curved top)
- 1 x 800mm x 500mm x 1000mm fabric covered table
- 1 x 6 foot table cover
- 1 x 850mm x 2000mm pull up banner
- 2 x leg connectors



### Exhibition Booth C Includes:

- 2 x 3m stretch fabric displays
- 2 x 1m stretch fabric displays (flat, angled or curved top)
- 1 x 800mm x 500mm x 1000mm fabric covered table
- 1 x 6 foot table cover
- 1 x 850mm x 2000mm pull up banner
- 3 x leg connectors

# Table Covers

## Drape or Fitted Table Covers

- Available in drape or fitted style with open or closed back and hemmed edges
- Full colour dye sublimation print on 240gsm knitted polyester
- Entire table cover can be printed
- Standard sizes:
  - 1800mm (6 Foot) table top - 1800mm x 700mm with 700mm fall (table cover total size 3200mm x 2100mm)
  - 2400mm (8 Foot) table top - 2400mm x 700mm with 700mm fall (table cover total size 3800mm x 2100mm)
  - Custom sizes available
- Standard lead time 10 - 15 days from artwork approval for orders up to 24 table covers. Please contact us for lead times for orders of 25 or more table covers



## Stretch Table Covers

- Full colour dye sublimation print on 200gsm stretch polyester fabric
- Entire table cover can be printed
- Available with an open back or closed back (with or without a zip)
- Size options:
  - 1200mm (4 foot) table top - 1230mm x 750mm with 610mm fall
  - 1800mm (6 foot) table top - 1820mm x 750mm with 720mm fall
  - 2400mm (8 foot) table top - 2410mm x 750mm with 720mm fall
- Standard lead time 10 - 15 days from artwork approval for orders up to 24 table covers. Please contact us for lead times for orders of 25 or more table covers



# Fabric Covered Tables

- Great for trade shows, exhibitions, presentations etc.
- Entire table cover can be printed
- Dye sublimation print on 250gsm knitted stretch fabric
- Includes light weight frame
- Table size:
  - 800mm x 500mm (table top) x 1000mm (h), 5kg
- Graphic size:
  - 2200mm x 1020mm
- Standard lead time 10 – 15 days from artwork approval



# Inflatables

- Full colour dye sublimation print
- Supplied with electric pump for inflation, ropes and pegs for installation and repair patches
- Please contact us for lead times



## Inflatable Arch

- Size options:
  - 3000mm x 2850mm
  - 5090mm x 3340mm
  - 7000mm x 5000mm

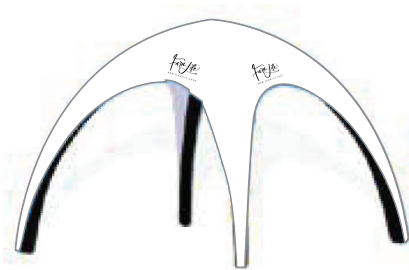

Air tent awnings and walls also available

## Inflatable Tent

- Size options:
  - 10 foot: 2400mm high x 3000mm wide
  - 13 foot: 3100mm high x 4000mm wide
  - 16 foot: 3650mm high x 5000mm wide
  - 20 foot: 4400mm high x 6000mm wide



## Inflatable Banner

- Size options:
  - 6 metres
  - 8 metres
  - 10 metres



## Inflatable Pillar

- Size options:
  - 400mm x 2500mm
  - 670mm x 3000mm



## Inflatable Table & Chairs

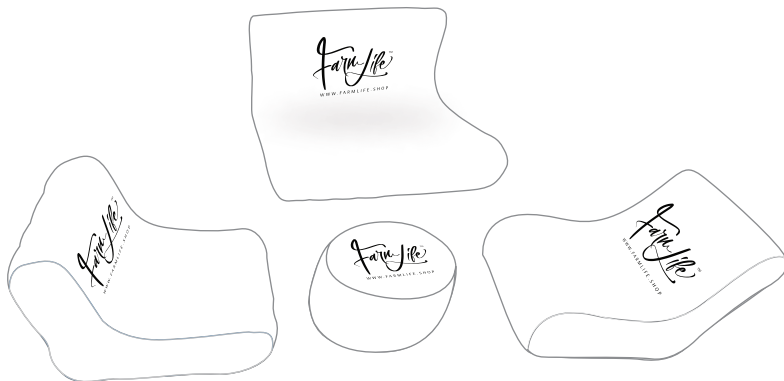

- Size - Table:
  - 680mm diameter x 380mm high
- Size options - Chairs:
  - Single Chair: 800mm x 1000mm x 700mm
  - Double Chair: 1680mm x 1000mm x 700mm

