

# **PARL** MOTORSPORTS

## INSTALLATION GUIDE



## HONDA CIVIC TYPE R (2023+) INTERCOOLER UPGRADE

# PRL INSTALLATION OVERVIEW

2

**PRODUCT:** PRL-HCR11-IC PRL MOTORSPORTS INTERCOOLER UPGRADE

**FITMENT:** 2023+ Honda Civic Type R

**INSTALLATION TIME:** Approximately 2 hours

**NOTE:** THIS ITEM DOES NOT REQUIRE AN ECU RE-CALIBRATION.

Please check that all components that are listed in the parts list have been supplied to you, and are correct. If you require any assistance or are missing components please email: [support@prlmotorsports.com](mailto:support@prlmotorsports.com). Please verify with a customer service representative before installation or returning the product.

## **PRODUCT DISCLAIMER:**

United States 48 State Compliant:

California/New York Residents please see Prop 65.

This is a Race Only product that is to be used solely for competition, it cannot be used on vehicles that are operated on public streets, roads or highways. Its use is limited to closed-course and open-course racing that is formally sanctioned by a recognized racing organization. Any other use including recreational use could be in violation of local, state and federal laws.

PRL Motorsports is not responsible for any vehicle damage or personal injury that may occur due to an installation error, product misuse, or removal of PRL Motorsports products. PRL Motorsports highly suggests that a trained professional conduct the installation on all products. PRL Motorsports is not responsible for damaged products due to incorrect installation.

## **REQUIRED TOOLS:**

Ratchet

Extension (6 - 12" Length)

10mm Socket

12mm Socket

Torque Wrench

Pliers

Phillips Head Screw Driver

Flat Head Screw Driver

Clip Removal Tool

Fresh Razor Blade

Drill

5/16 " Drill Bit



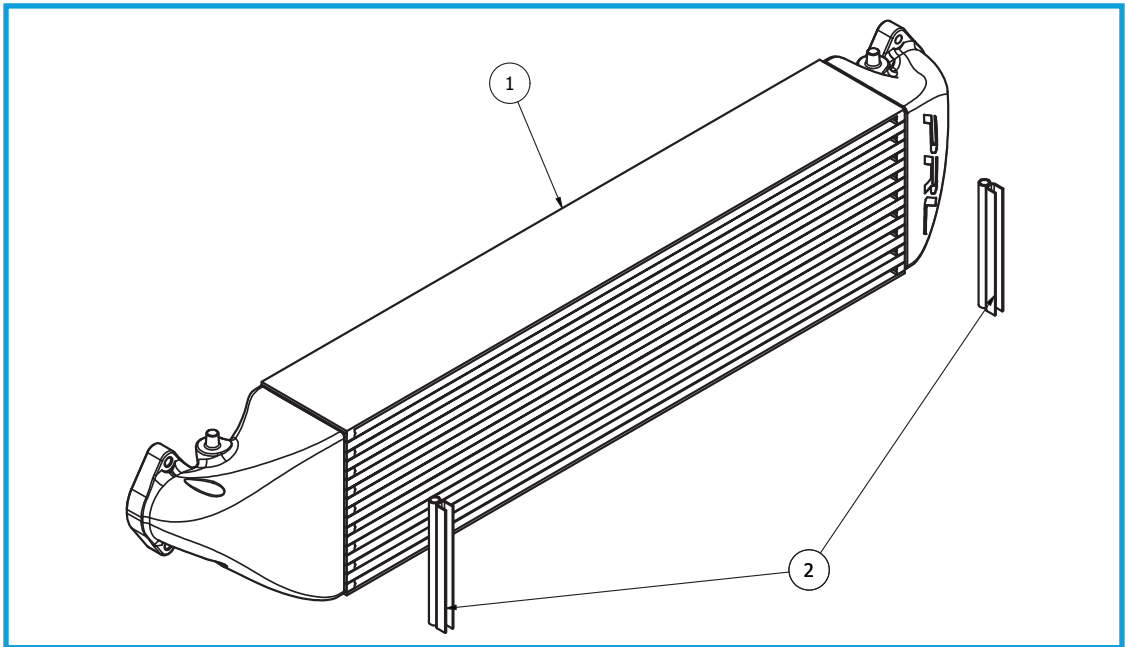

## COMPONENT LIST

#	PART #	QTY	DESCRIPTION
1	RAW-HCR11-IC	1	2023+ Honda Civic Type R Intercooler
2	MCM-1120A322	2	3/16" Push on Seal

- 1 Using a phillips head screwdriver, remove the screws from the wheel well to free the fender liner from the front bumper cover.



- 2 Remove all of the clips attaching the factory undertray/skid plate to the front bumper using your clip removal tool.

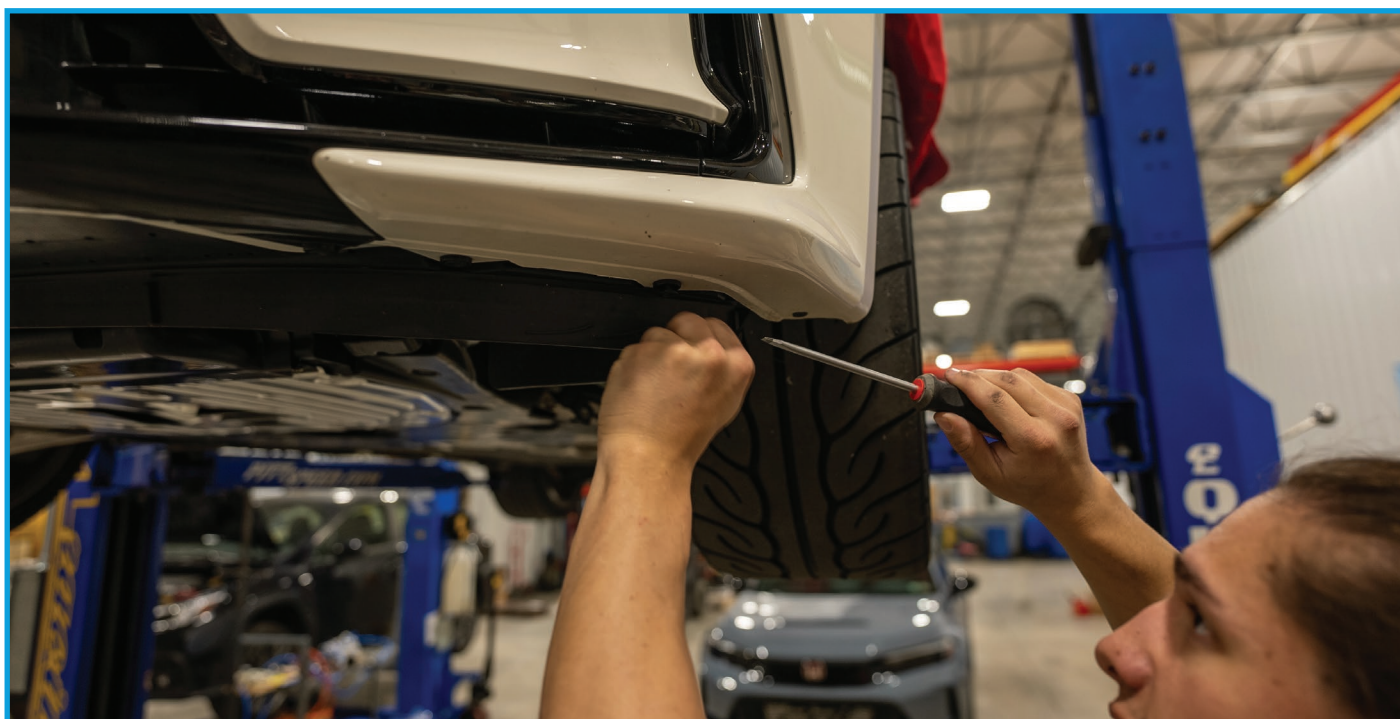

3

With a clip removal tool or flat head screwdriver, remove all of the clips securing the front bumper to the top of the radiator support. You should be able to gently remove the front bumper, taking care with the clips around the headlights.

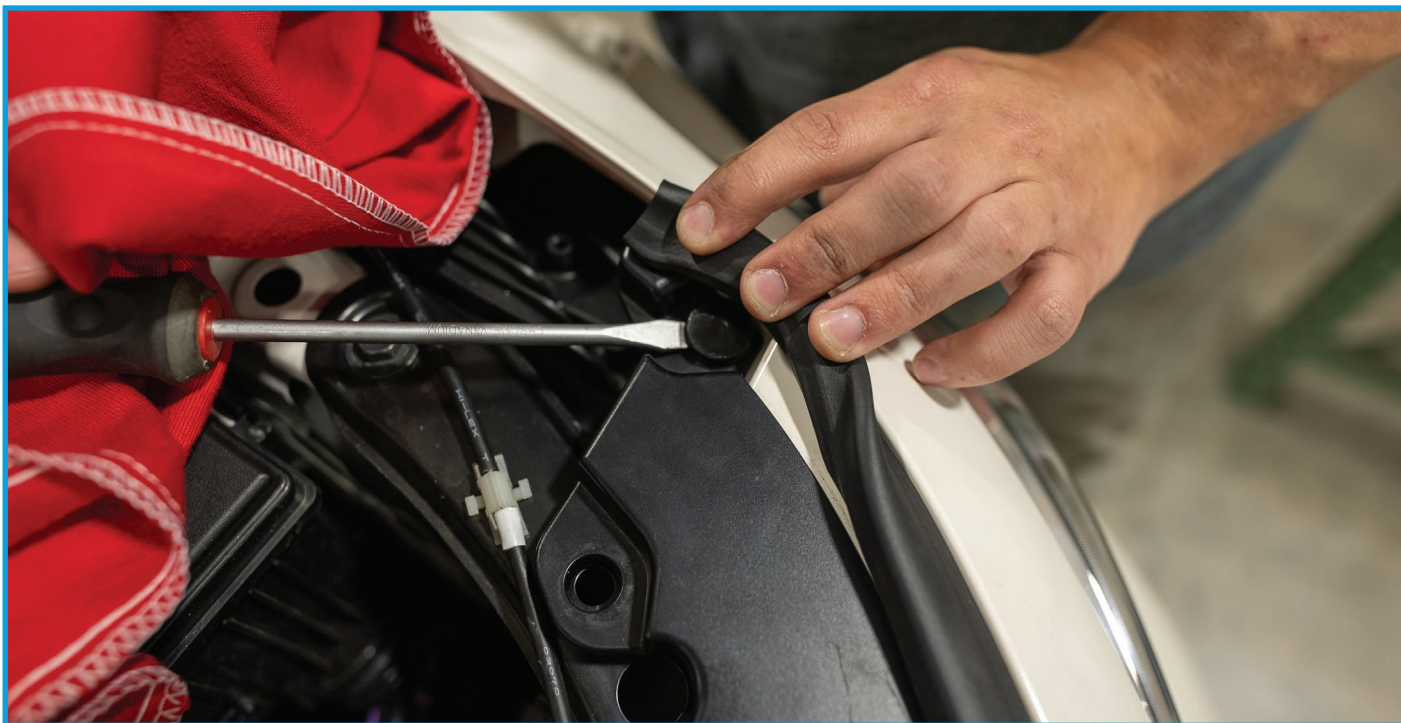

4

Now that you have access to the factory intercooler, remove the 2 12mm bolts on the drivers-side flange connecting the intercooler to the charge piping.

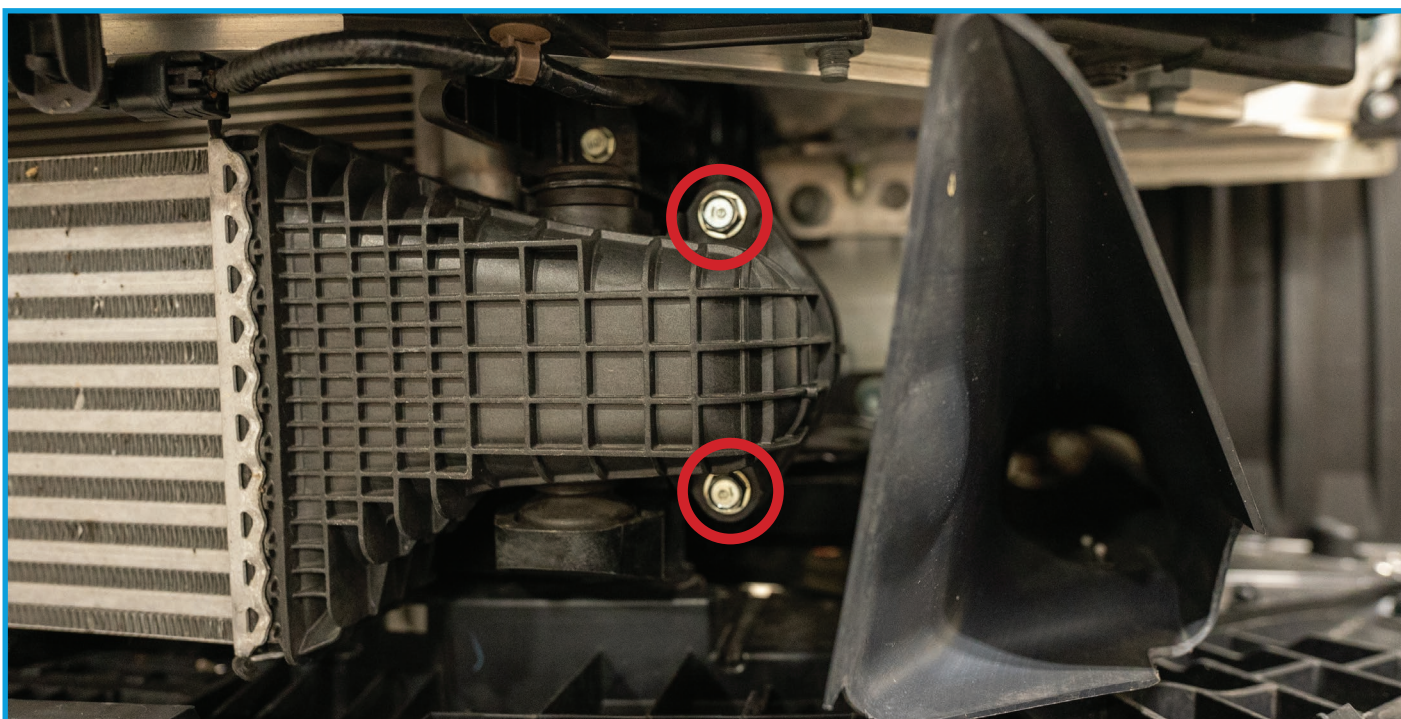

5

Repeat step 4 on the passenger side of the car as well. Remove the 2 12mm bolts on the intercooler flange connecting to the charge pipe.

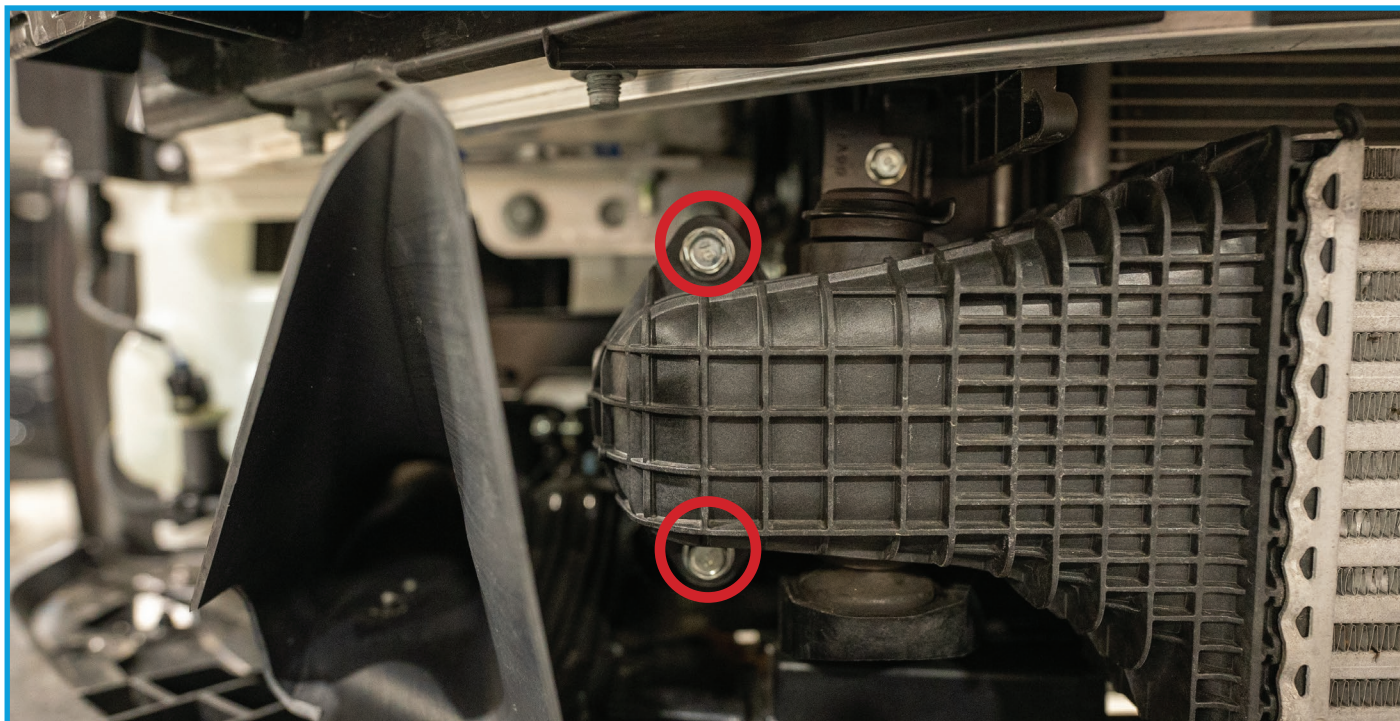

6

With a long extension on your ratchet, remove the 12mm bolt securing the factory intercooler mount to the chassis. Remove these mounts from both sides of the vehicle.



- 7 Locate the ambient air temperature sensor mounted to the black plastic air dam running across the front of the car. Using your pliers, gently pinch the retention clip to remove the sensor.



- 8 We will need to remove the mounting tab to make clearance for the larger intercooler. Using a sharp razor blade or some shears, trim away the plastic tab that the air temp sensor was mounted to.



9

Drill a 5/16" hole through the bottom of the plastic air dam slightly offset from the original mounting location.



10

With your new hole drilled, you can pop the temperature sensor mounting clip through from the bottom of the air dam to secure it in place.





11

Now that the chassis is prepped, we need to prep the PRL Intercooler for installation. Grab the two rubber o-rings off of the factory intercooler charge-pipe flanges.

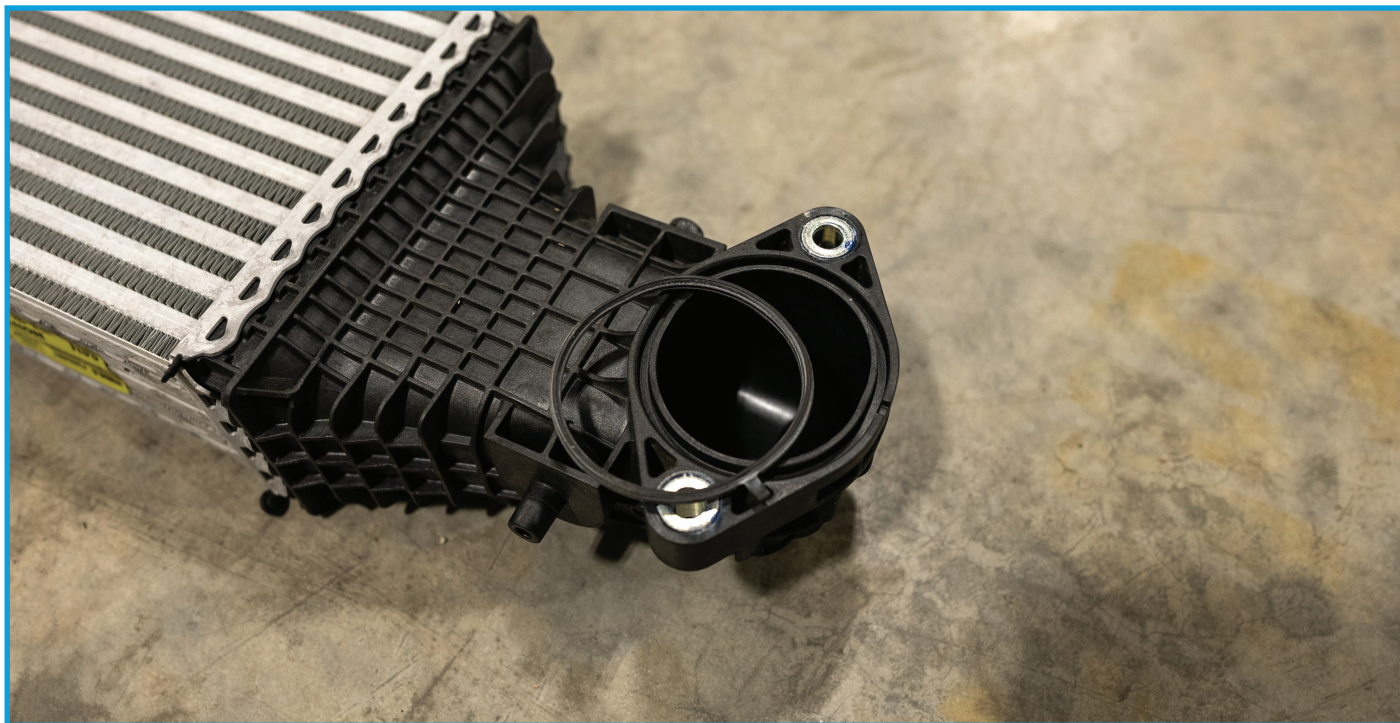

12

Using a sharp blade, trim the small tab off of the outside of both o-rings, taking care not to nick or cut the circular portion of the ring.



13

Before installing the o-rings onto your PRL Intercooler, make sure that they are clear of any dust or debris so they can create a tight seal against the chargepipes. Pop them in place in the machined grooves on your new Intercooler.



14

We will also be retaining the factory mounting grommet located on the sides of the intercooler. Simply pop the rubber grommets off of the factory intercooler and slide them onto the peg on your PRL unit in the same orientation.



15

You can now install your PRL Intercooler onto the car. Ensure that the machined 'PRL' Logo is on the left-hand (USDM driver's side) of the car. Start with the mounting grommet on the passenger side and bolt it into place using the factory bracket and 12mm bolt. Torque this bolt to 18 ft/lbs. Repeat for the driver side mount as well.

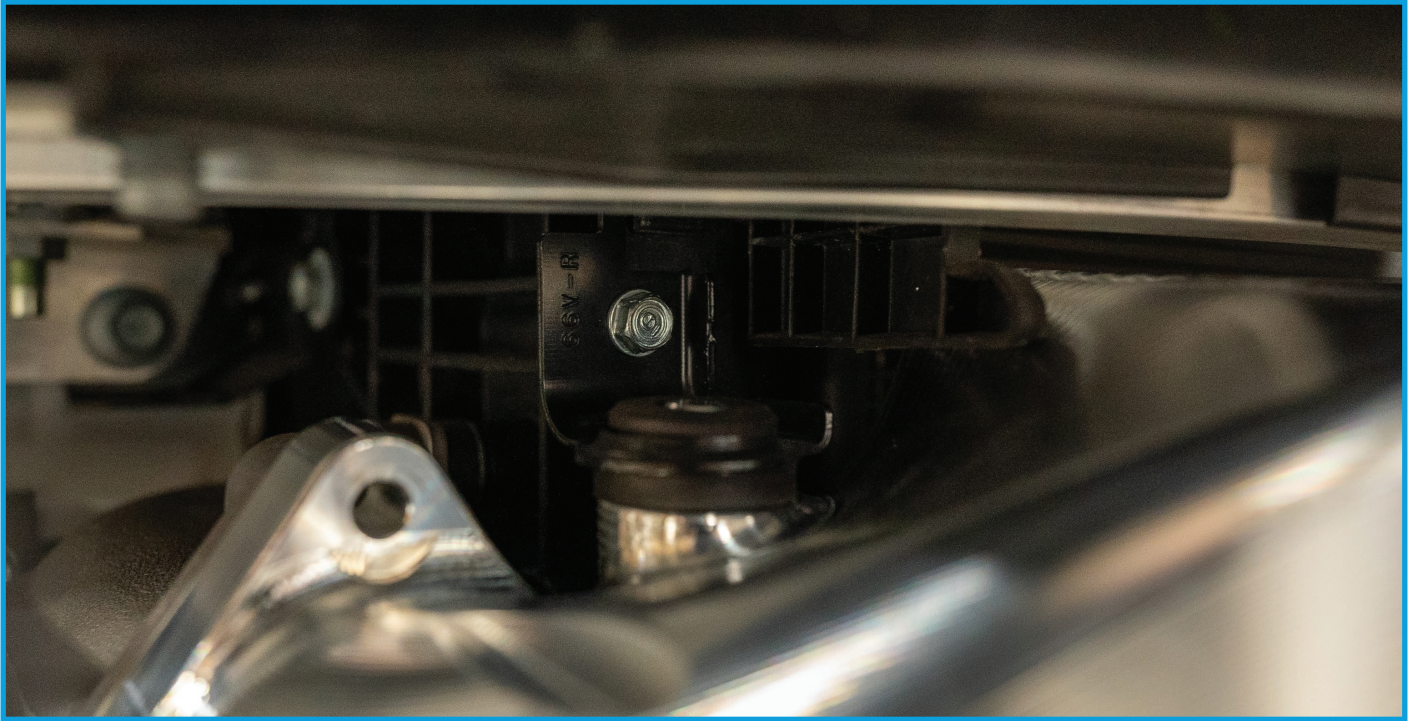

16

Next, fully secure the intercooler in place by bolting it up to the chargepipes. Re-use the 4 of the factory 12mm flange bolts to bolt these together. Torque all of these bolts to 18 ft/lbs.

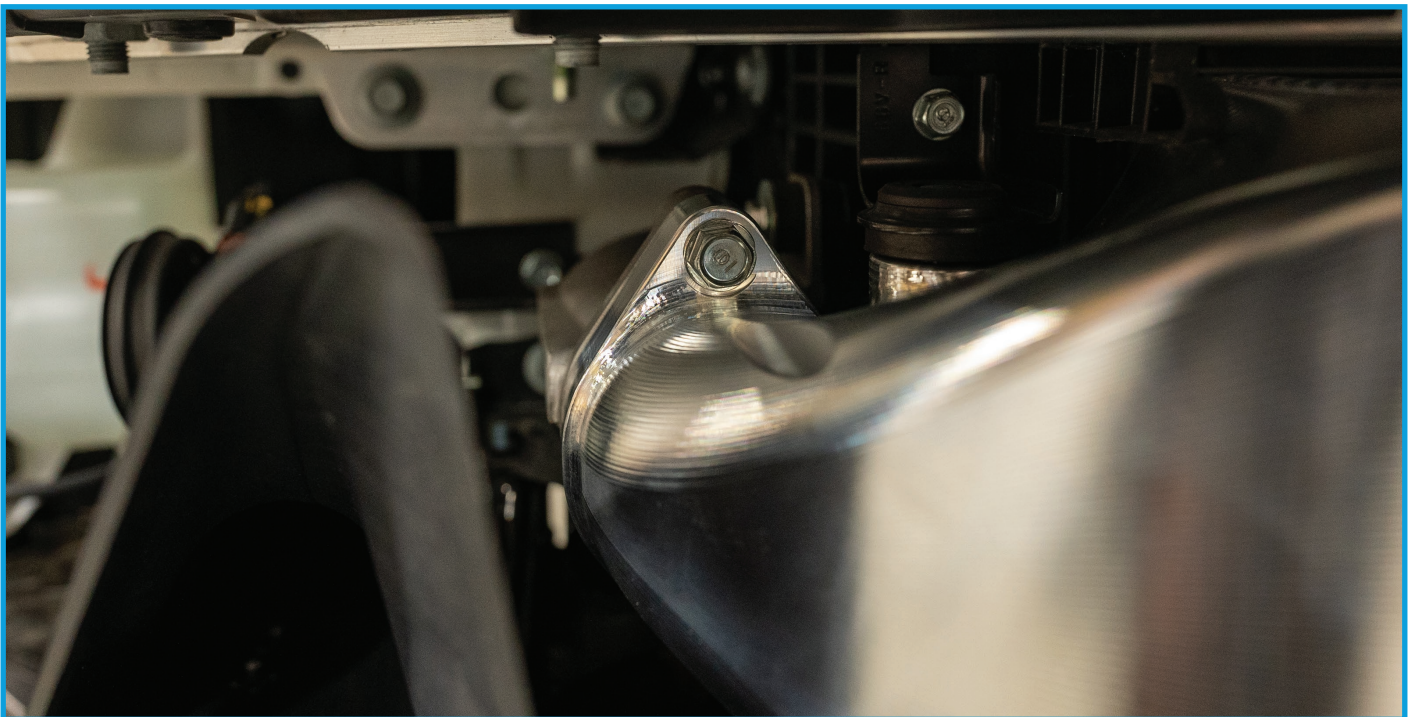

17

Before re-installing the bumper, we will need to get rid of the factory air dams to make room for the thicker intercooler core. You can remove them by simply undoing these 2 phillips head screws. Repeat this on both sides of the bumper.



18

To ensure that you are getting the maximum airflow through your PRL Intercooler, install the included rubber gasket material onto both sides of the plastic intercooler grill.



## Road Testing Your PRL Intercooler Upgrade

1. Start the vehicle with the transmission in neutral and the emergency brake engaged. Assess to make sure of any possible issue(s) and then make any subsequent adjustments as they are needed.
2. Test drive the vehicle to ensure everything is in working order.
3. If after the road testing, everything is good to go, enjoy your PRL Intercooler Upgrade! Thank you for being a part of the #PRLARMY.

**If you have any questions/concerns please reach out to us at:**

[support@PRLMotorsports.com](mailto:support@PRLMotorsports.com)

Please provide a full description of your issue, ideally with any pertinent images or video clips that can help our team address the issue.

Please note: All support tickets are addressed during business hours and in order of received.

As stated at the beginning of this guide, the PRL Intercooler Upgrade has been specifically designed to be 100% compatible with the factory ECU calibration. No tuning is required to benefit from the advertised gains and performance. Our intercooler is designed to fit like factory but be a more optimal and overall better performing unit. Under conditions in which the horsepower of the vehicle is increased, this unit is rated for 600HP.

## Required Maintenance

PRL Motorsports thoroughly recommends visually inspecting your products during any routine maintenance like oil changes, tire rotations, and filter changes or cleanings. Please make sure to check your connections on all mounted parts periodically to ensure that they have not come loose over time. Always make sure to not drive through any debris that can damage the fins of the intercooler. Nor drive over or into anything that could puncture or crack the intercooler.



1400 RANDALL COURT - UNIT 104  
EXPORT, PENNSYLVANIA 15632  
[www.PRLMotorsports.com](http://www.PRLMotorsports.com)

Follow Us!  
PRLMotorsports

