

WARNING!
 Not suitable for children under 36 months. Choking hazard. Only for use by children over 8 years old. To be used solely under the strict supervision of adults that have studied the precautions given in the experimental set.

Water toys sometimes get messy. Protect play surfaces before use. Drain, rinse, clean and dry all items thoroughly before storing.

Packaging materials are not toys. Please remove all packaging before giving this toy to your child.

Did you know
 Hydraulics is a branch of science and engineering concerned with the use of liquids to perform mechanical tasks.

Hydraulic machinery are machines and tools which use fluid power to do simple work. Heavy equipment is a common example. Excavators, cranes, wood loader, hydraulic grab, fire engine and bulldozer all make use of this principle.

Typically, the fluid used in a hydraulic system is an incompressible liquid such as water or oil. Pressure is applied by a piston to the fluid in a rigid vessel, causing the fluid to press on another piston that delivers energy to a load. If the areas of the two pistons are different, then the force applied to the first piston will be different from the force exerted by the second piston. This creates a mechanical advantage, which is the number of times a machine multiplies your effort force.

In hydraulic machine, high-pressure liquid — called hydraulic fluid — is transmitted throughout the machine to various hydraulic motors and hydraulic cylinders. The fluid is controlled directly or automatically by control valves and distributed through hoses and tubes.

- Components:**
- | | |
|---------------------|-----------------------|
| 1. 1 Frame | 14. 1 Handle |
| 2. 1 Long arm | 15. 1 Flow divider |
| 3. 1 Middle arm | 16. 8 Tube rings |
| 4. 1 Short arm | 17. 1 Hand pump |
| 5. 2 Cab parts | 18. 2 Arm stand parts |
| 6. Soft tube | 19. 1 Short pin |
| 7. Soft tube | 20. 3 Pump holders |
| 8. Soft tube | 21. 18 Caps |
| 9. Soft tube | 22. 4 Wheels |
| 10. 3 Mini pumps | 23. 4 Pins |
| 11. 2 Tracks | |
| 12. 1 Work platform | |
- 

Assemble your Hydraulic Fire Engine

1. Attach the wheels (22) to the frame (1) using the pins (23).



2. Cover the wheels with the tracks (11).



3. Attach the work platform (12) to the short arm (4).



4. Slide the short arm into the middle arm (3).



5. Install the short pin (19) to the hole of the short arm.



6. Connect the middle arm to the long arm (2).



7. Attach the arm stand parts (18) to each side of the long arm.



8. Install the arm by inserting the arm stand to the corresponding slots on the frame.



9. Install a pump holder (20) to each mini pump (10).



10. Fill the mini pump by dipping its head into a cup of water and lift the plunger.



11. Point the mini pump upwards.



12. Expel the water from the mini pump by pushing the plunger all the way to the top. The tip of the mini pump should still be filled with water. Repeat steps 9-12 for all three mini pumps.



13. Install a tube ring (15) to each of the three shorter soft tubes (7,8,9).

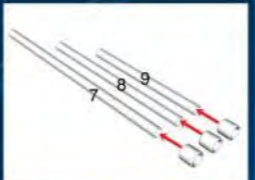

14. Attach the three tubes (7,8,9) to the flow divider (14) output marked '1', '2', '3' respectively. Secure the tubes by sliding the tube ring to the interconnection.

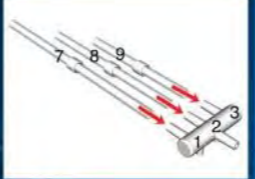

15. Attach a tube ring to the remaining soft tube (6) and connect it to the input tube of the flow divider. Secure it with the tube ring.

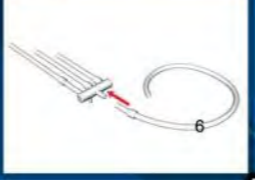

16. Attach a tube ring to the soft tubes (7,8,9).

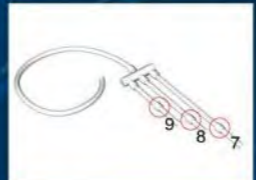

17. Connect a mini pump to the two longer soft tubes as shown.



18. Combine the handle (13) and the hand pump (16).



19. Press the handle of the hand pump to the lowest position and dip it into a cup of water.



20. Fill the hand pump with water by pulling the handle to the top.



21. Install a tube ring to the free end of the long soft tube (6). Connect the hand pump to the soft tube.



22. Press the handle of the hand pump to fill the open soft tube (9) with water.



23. Connect a mini pump to the shortest soft tube (9). Make sure no air is trapped inside the tube or the mini pump. Secure the connection with the tube ring.



24. Detach the hand pump from the soft tube.



25. Dip the pump into a cup of water again.



26. Fill the hand pump with water by pulling the handle to the top.



27. Connect the hand pump to the soft tube.



28. Detach the middle mini pump from the soft tube.



29. Press the handle of the hand pump to fill the middle soft tube (8) with water.



30. Attach the mini pump back to the soft tube. Make sure no air is trapped inside the tube or the mini pump. Secure the connection with the tube ring. Detach the hand pump from the soft tube.



31. Dip the pump into a cup of water again.



32. Pull the handle to fill it with water.



33. Connect the hand pump to the soft tube.



34. Detach the mini pump from the longer soft tube (7).



35. Press the handle of the hand pump to fill the open soft tube (7) with water.



36. Attach the mini pump back to the soft tube. Make sure no air is trapped inside the tube or the mini pump. Secure the connection with the tube ring. Detach the hand pump from the soft tube.



37. Dip the pump into a cup of water again.



38. Pull the handle to fill it with water.



39. Connect the hand pump to the soft tube and secure it with the tube ring at the interconnection.



40. Attach the hand pump covers (17) to the hand pump.



41. Install the flow divider onto the frame as shown.

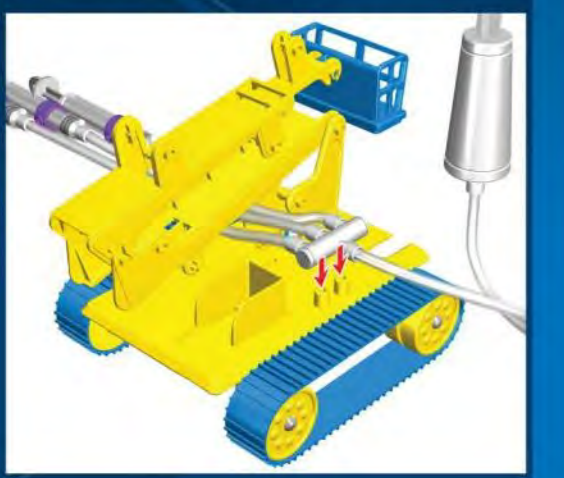

42. Attach the hand pump to the frame.



43. Install the mini pumps to the arms by aligning the holes of the pump holders to the pins of the arms and arm stand as shown. The plungers should also be clipped to the corresponding pin on each arm.

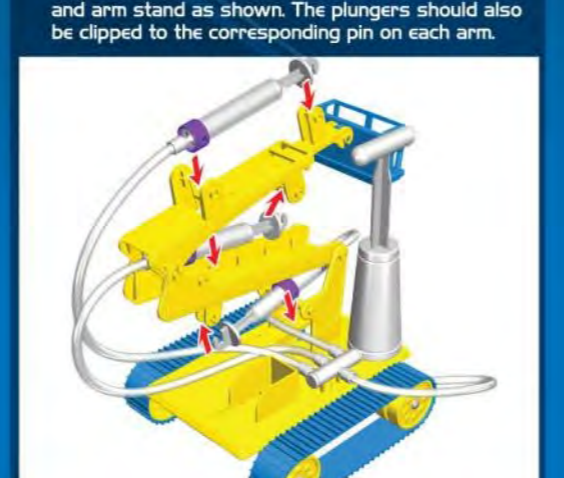

44. Install the caps (21) as shown.



45. Combine the cab parts (5).

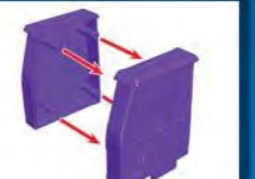

46. Install the cab onto the frame.



47. Done! Push and pull the handle of the hand pump and note how the plunger of each mini pump control the movement of the arm of the fire engine!

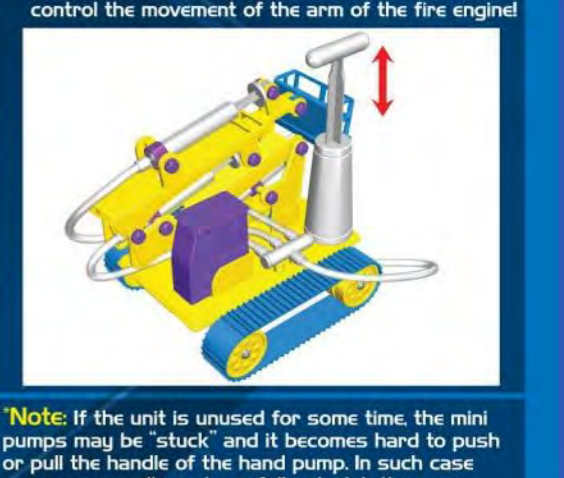





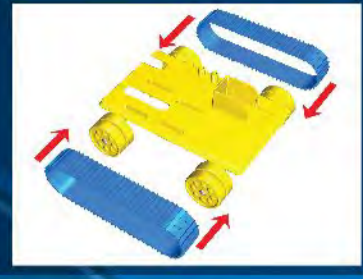
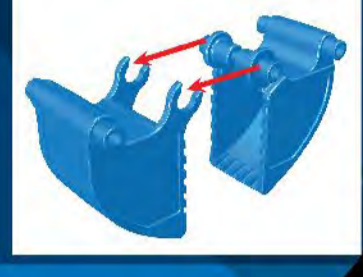

Note: If the unit is unused for some time, the mini pumps may be "stuck" and it becomes hard to push or pull the handle of the hand pump. In such case you can manually and carefully stretch the arms several times to reduce the friction inside the mini pumps. It will resume normal function afterwards.



WARNING!
 Not suitable for children under 36 months. Choking hazard. Only for use by children over 8 years old. To be used solely under the strict supervision of adults that have studied the precautions given in the experimental set.
 Water toys sometimes get messy. Protect play surface before use. Drain, rinse, clean and dry all items thoroughly before storing.
 Packaging materials are not toys. Please remove all packaging before giving this toy to your child.
Did you know
 Hydraulics is a branch of science and engineering concerned with the use of liquids to perform mechanical tasks.
 Hydraulic machinery are machines and tools which use fluid power to do simple work. Heavy equipment is a common example. Excavators, crane, wood loader, hydraulic grab, fire engine and bulldozer all make use of this principle.
 Typically, the fluid used in a hydraulic system is an incompressible liquid such as water or oil. Pressure is applied by a piston to the fluid in a rigid vessel, causing the fluid to press on another piston that delivers energy to a load. If the areas of the two pistons are different, then the force applied to the first piston will be different from the force exerted by the second piston. This creates a mechanical advantage, which is the number of times a machine multiplies your effort force.
 In hydraulic machine, high-pressure liquid — called hydraulic fluid — is transmitted throughout the machine to various hydraulic motors and hydraulic cylinders. The fluid is controlled directly or automatically by control valves and distributed through hoses and tubes.



- Components:**
- | | |
|-----------------------|------------------------|
| 1. 1 Frame | 13. 2 Buckets |
| 2. 4 Links | 14. 1 Handle |
| 3. 2 Upper boom parts | 15. 1 Flow divider |
| 4. 2 Main boom parts | 16. 8 Tube rings |
| 5. 2 Dipper arm parts | 17. 1 Hand pump |
| 6. 2 Cab parts | 18. 2 Hand pump covers |
| 7. Soft tube | 19. 2 Boom stand parts |
| 8. Soft tube | 20. 4 Pump holders |
| 9. Soft tube | 21. 2 Caps |
| 10. Soft tube | 22. 4 Wheels |
| 11. 3 Mini pumps | 23. 4 Pins |
| 12. 2 Tracks | |
- 

- Assemble your Hydraulic Grab**
1. Attach the wheels (22) to the frame (1) using the pins (23).
 2. Cover the wheels with the tracks (12).
 3. Join the buckets (13).
- 
- 
- 



4. Combine the dipper arms (5).
 5. Connect the bucket to the dipper arm using the links (2) and caps (21).
 6. Combine the upper boom parts (3) and attach the dipper arm to it.
- 
- 
- 

7. Combine the main boom parts (4) with the upper boom inside.
 8. Attach the boom stand parts (19) to each side of the main boom.
 9. Install the boom by inserting the boom stand to the corresponding slots on the frame.
- 
- 
- 

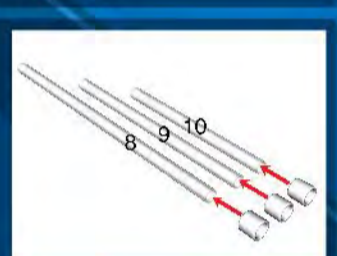
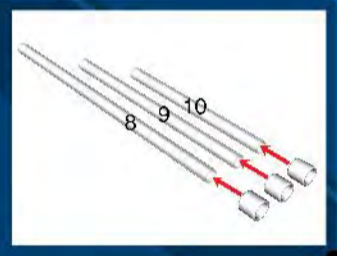

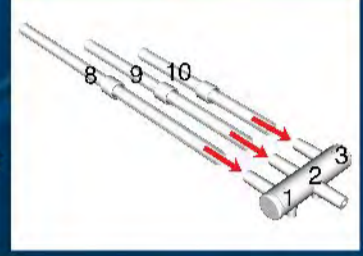
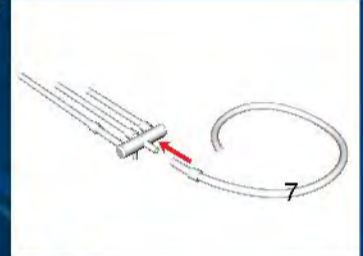
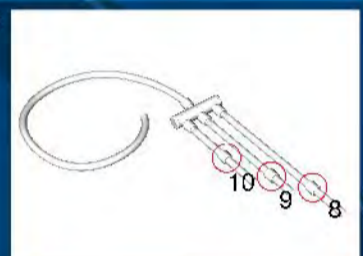
10. Install a pump holder (20) to a mini pump (11).
 11. Fill the mini pump by dipping its head into a cup of water and lift the plunger.
 12. Point the mini pump upwards.
- 
- 
- 

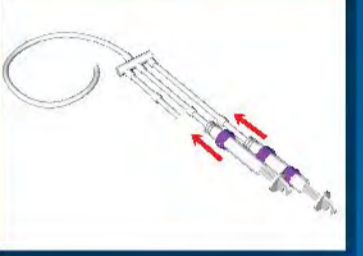

13. Expel the water from the mini pump by pushing the plunger all the way to the top. The tip of the mini pump should still be filled with water. Repeat steps 10-13 for another mini pump.
 14. Install two pump holders (20) to the third mini pump (11).
 15. Repeat steps 11-13 for this mini pump.
 16. Install a tube ring (16) to each of the three shorter soft tubes (8,9,10).
- 
- 
- 
- 

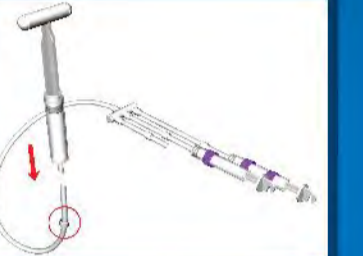
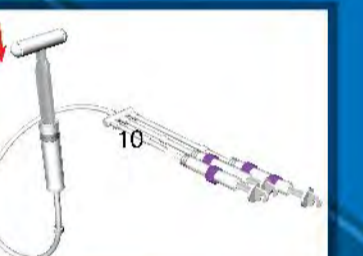

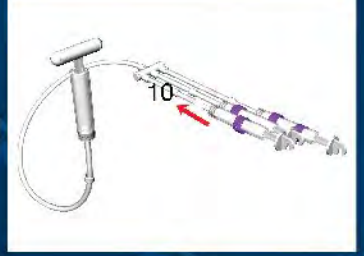
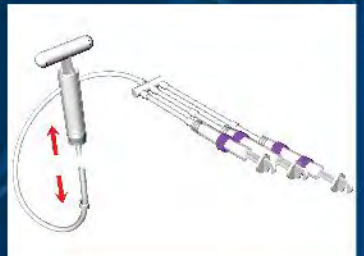
17. Attach the three tubes (8,9,10) to the flow divider (15) output marked '1', '2', '3' respectively. Secure the tubes by sliding the tube ring to the interconnection.
 18. Attach a tube ring to the remaining soft tube (7) and connect it to the input tube of the flow divider. Secure it with the tube ring.
 19. Attach a tube ring to the soft tubes (8,9,10).
- 
- 
- 

20. Connect the mini pump with 2 pump holders to the tube (8) and another mini pump to the middle soft tube (9).
 21. Combine the handle (14) and the hand pump (17).
 22. Press the handle of the hand pump to the lowest position and dip it into a cup of water.
- 
- 
- 

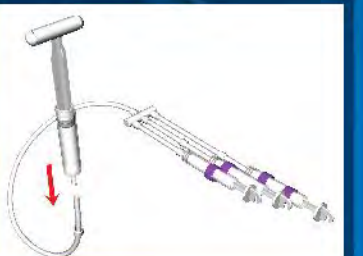
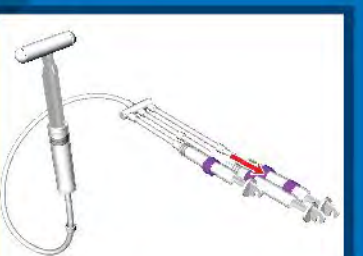
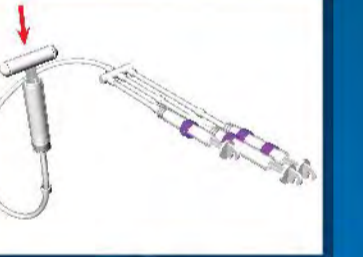
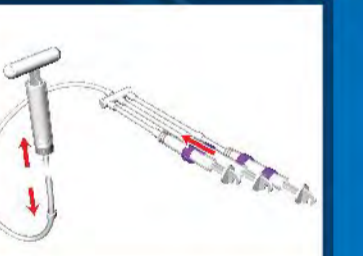
23. Fill the hand pump with water by pulling the handle to the top.
 24. Install a tube ring to the free end of the long soft tube (5). Connect the hand pump to the soft tube.
 25. Press the handle of the hand pump to the lowest position and dip it into a cup of water.
- 
- 
- 

26. Connect a mini pump to the shortest soft tube (10). Make sure no air is trapped inside the tube or the mini pump. Secure the connection with the tube ring.
 27. Detach the hand pump from the soft tube.
 28. Dip the pump into a cup of water again.
- 
- 
- 

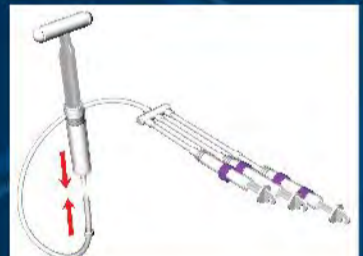
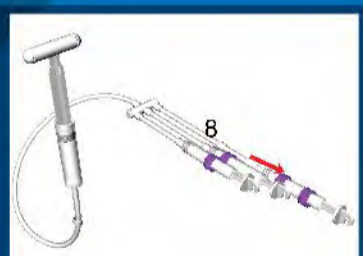
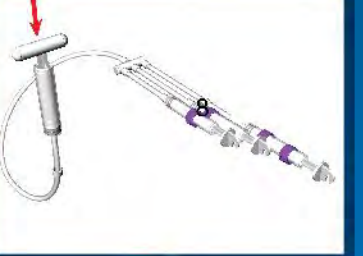
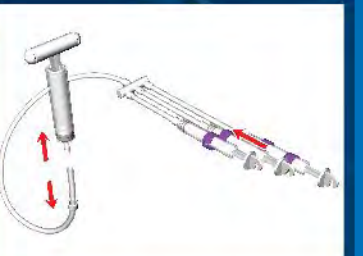
29. Fill the hand pump with water by pulling the handle to the top.
 30. Connect the hand pump to the soft tube.
 31. Detach the middle mini pump from the soft tube.
 32. Press the handle of the hand pump to fill the middle soft tube (9) with water.
 33. Attach the mini pump back to the middle soft tube. Make sure no air is trapped inside the tube or the mini pump. Secure the connection with the tube ring. Detach the hand pump from the soft tube.
 34. Dip the pump into a cup of water again.
- 
- 
- 
- 
- 
- 

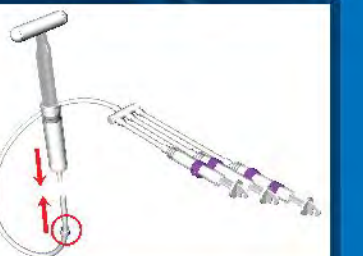
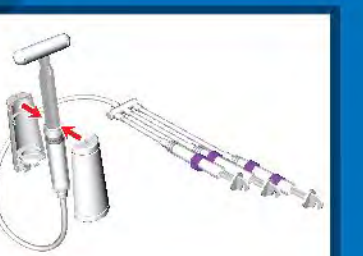

35. Pull the handle to fill it with water.
 36. Connect the hand pump to the soft tube.
 37. Detach the mini pump from the longer soft tube (8).
 38. Press the handle of the hand pump to fill the open soft tube (8) with water.
 39. Attach the mini pump back to the soft tube. Make sure no air is trapped inside the tube or the mini pump. Secure the connection with the tube ring. Detach the hand pump from the soft tube.
 40. Dip the pump into a cup of water again.
- 
- 
- 
- 
- 
- 

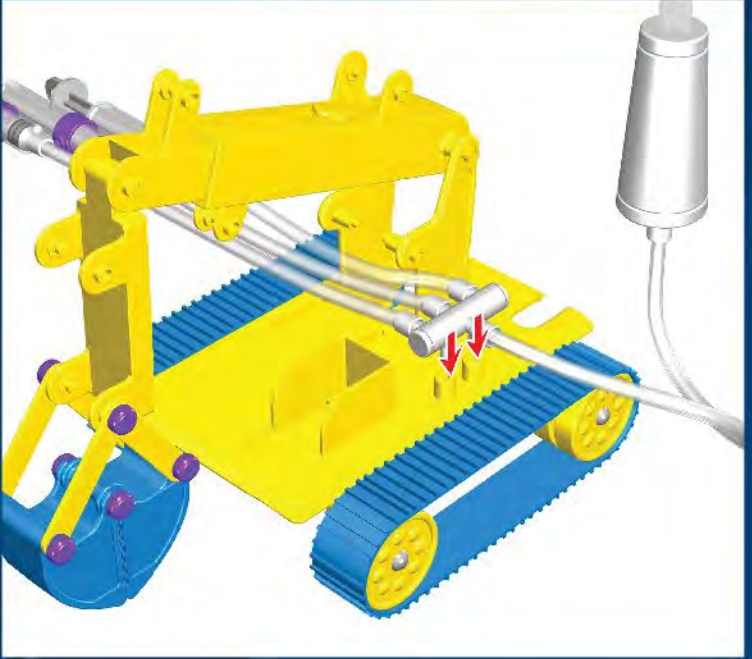
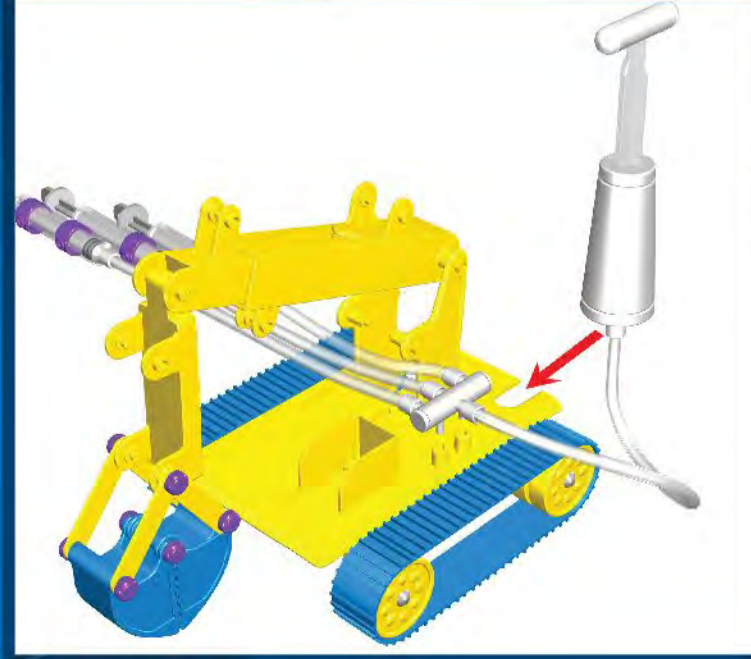
41. Pull the handle to fill it with water.
 42. Connect the hand pump to the soft tube and secure it with the tube ring at the interconnection.
 43. Attach the hand pump covers (18) to the hand pump.
- 
- 
- 

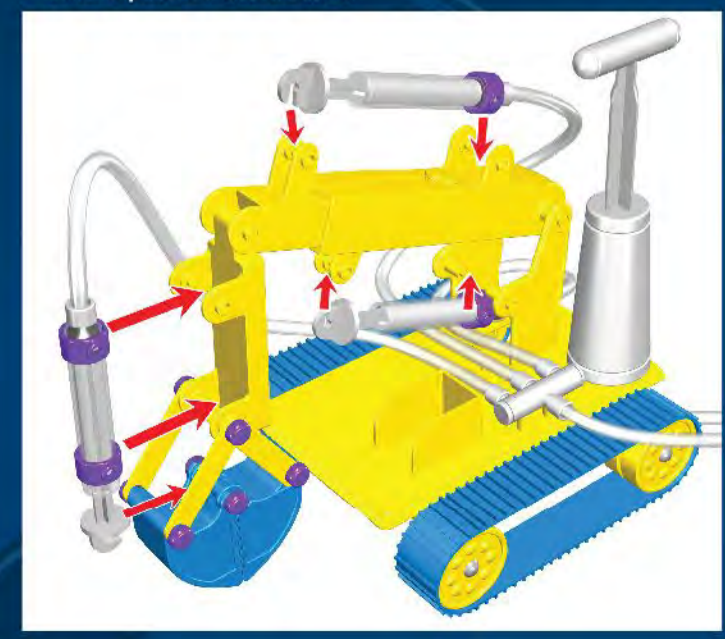
44. Install the flow divider onto the frame as shown.
 45. Attach the hand pump to the frame.
- 
- 

46. Install the mini pumps to the boom by aligning the holes of the pump holders to the pins of the boom and dipper arm as shown. The plungers should also be clipped to the corresponding pin on the boom. The plunger of the mini pump of the dipper arm should be clipped to the centre pole of the bucket.
- 

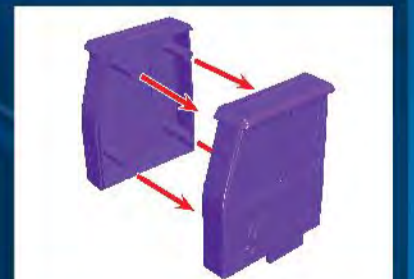
47. Install the remaining 14 caps (21) as shown.
- 



48. Combine the cab parts (6).
 49. Install the cab onto the frame.
- 
- 



50. Done! Push and pull the handle of the hand pump and note how the plunger of each mini pump controls the movement of the boom and the bucket!
- 
- Note:** If the unit is unused for some time, the mini pumps may be "stuck" and it becomes hard to push or pull the handle of the hand pump. In such case you can manually and carefully stretch the moving parts several times to reduce the friction inside the mini pumps. It will resume normal function afterwards.



WARNING!
 Not suitable for children under 36 months. Choking hazard. Only for use by children over 8 years old. To be used solely under the strict supervision of adults that have studied the precautions given in the experimental set.
 Water toys sometimes get messy. Protect play surface before use. Drain, rinse, clean and dry all items thoroughly before storing.
 Packaging materials are not toys. Please remove all packaging before giving this toy to your child.



Did you know?
 Hydraulics is a branch of science and engineering concerned with the use of liquids to perform mechanical tasks.
 Hydraulic machinery are machines and tools which use fluid power to do simple work. Heavy equipment is a common example. Excavators, cranes, wood loader, hydraulic grab, fire engine and bulldozer all make use of this principle.
 Typically, the fluid used in a hydraulic system is an incompressible liquid such as water or oil. Pressure is applied by a piston to the fluid in a rigid vessel, causing the fluid to press on another piston that delivers energy to a load. If the areas of the two pistons are different, then the force applied to the first piston will be different from the force exerted by the second piston. This creates a mechanical advantage which is the number of times a machine multiplies your effort force.
 In hydraulic machine, high-pressure liquid — called hydraulic fluid — is transmitted throughout the machine to various hydraulic motors and hydraulic cylinders. The fluid is controlled directly or automatically by control valves and distributed through hoses and tubes.

- Components**
- | | |
|----------------------|------------------------|
| 1. 1 Frame | 12. 2 Tracks |
| 2. 2 Boom parts | 13. 2 Lower fork arms |
| 3. 2 Upper fork arms | 14. 1 Hand pump |
| 4. 4 Pins | 15. 2 Hand pump covers |
| 5. 2 Pump holders | 16. 2 Boom stand parts |
| 6. 2 Cab parts | 17. 1 Fork connector |
| 7. Soft tube | 18. 6 Tube rings |
| 8. Soft tube | 19. 1 Flow divider |
| 9. Soft tube | 20. 12 Caps |
| 10. 2 Mini pumps | 21. 4 Wheels |
| 11. 1 Handle | |
- 

- Assemble your Hydraulic Wood Loader**
1. Attach the wheels (21) to the frame (1) using the pins (4).
 2. Cover the wheels with the tracks (12).
 3. Combine the boom parts (2).
- 
- 
- 

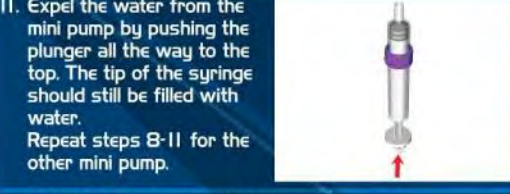

4. Attached the lower fork arms (13) to the boom and the fork connector (17).
 5. Attach the upper fork arms (3) to the boom connector (17).
 6. Attach the boom stand parts (16) to each side of the boom.
- 
- 
- 

7. Install the boom by inserting the boom stand to the corresponding slots on the frame.
 8. Install a pump holder (5) to each mini pump (10).
 9. Fill the mini pump by dipping its head into a cup of water and lift the plunger.
- 
- 
- 

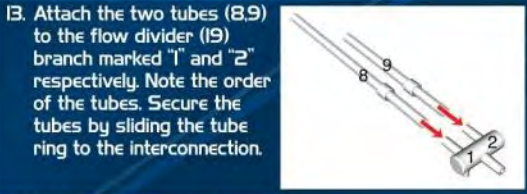
10. Point the mini pump upwards.
 11. Expel the water from the mini pump by pushing the plunger all the way to the top. The tip of the syringe should still be filled with water. Repeat steps 8-11 for the other mini pump.
 12. Install a tube ring (18) to each of the two shorter soft tubes (8,9).
- 
- 
- 

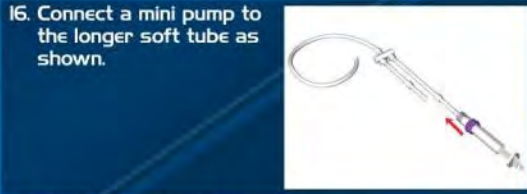
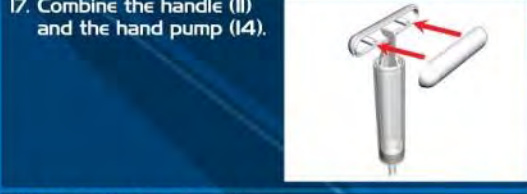
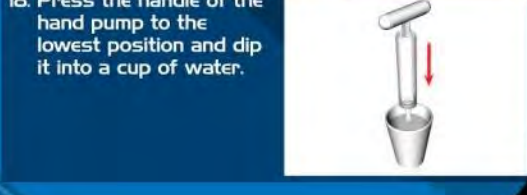
13. Attach the two tubes (8,9) to the flow divider (19) branch marked "1" and "2" respectively. Note the order of the tubes. Secure the tubes by sliding the tube ring to the interconnection.
 14. Attach a tube ring to the remaining soft tube (7) and connect it to the input tube of the flow divider. Secure it with the tube ring.
 15. Attach a tube ring to the soft tubes (8,9).
- 
- 
- 

16. Connect a mini pump to the longer soft tube as shown.
 17. Combine the handle (11) and the hand pump (14).
 18. Press the handle of the hand pump to the lowest position and dip it into a cup of water.
- 
- 
- 

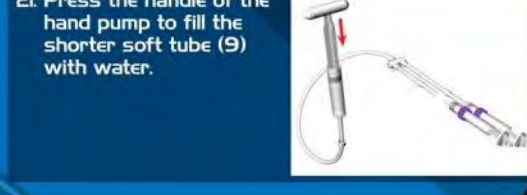

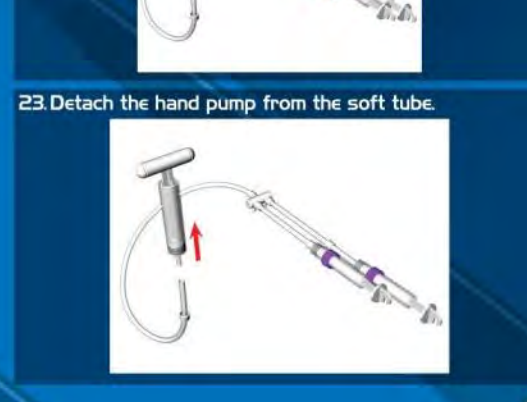
19. Fill the hand pump with water by pulling the handle to the top.
 20. Install a tube ring to the free end of the long soft tube (7). Connect the hand pump to the soft tube.
 21. Press the handle of the hand pump to fill the shorter soft tube (9) with water.
- 
- 
- 

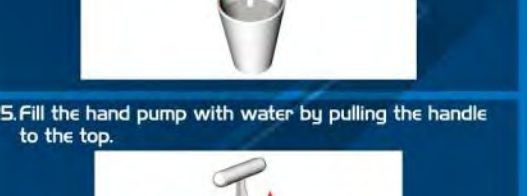

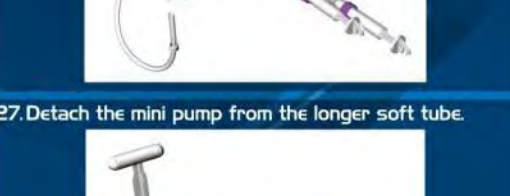
22. Connect a mini pump to the shorter soft tube (9). Make sure no air is trapped inside the tube or the mini pump. Secure the connection with the tube ring.
 23. Detach the hand pump from the soft tube.
- 
- 

24. Dip the pump into a cup of water again.
 25. Fill the hand pump with water by pulling the handle to the top.
- 
- 

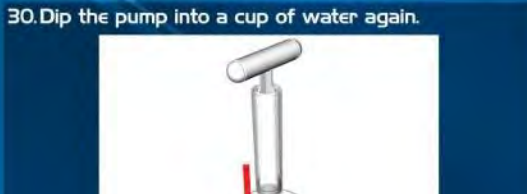
26. Connect the hand pump to the soft tube.
 27. Detach the mini pump from the longer soft tube.
- 
- 

28. Press the handle of the hand pump to fill the longer soft tube with water.
 29. Attach the mini pump back to the soft tube. Make sure no air is trapped inside the tube or the syringe. Secure the connection with the tube ring. Detach the hand pump from the soft tube.
- 
- 

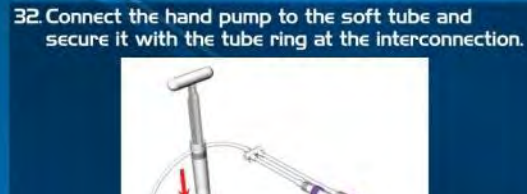
30. Dip the pump into a cup of water again.
 31. Pull the handle to fill it with water.
- 
- 

32. Connect the hand pump to the soft tube and secure it with the tube ring at the interconnection.
 33. Attach the hand pump covers (15) to the hand pump.
- 
- 

34. Install the flow divider onto the frame as shown.
- 

35. Attach the hand pump to the frame.
- 

36. Install the mini pump with the shorter tube to the boom by aligning the holes of the pump holder to the pins of the boom stand as shown. The plunger should also be clipped to the corresponding pin on the backside of the boom.
- 

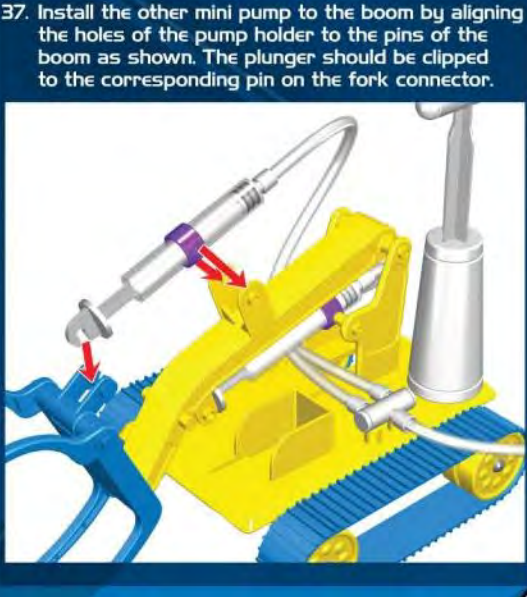
37. Install the other mini pump to the boom by aligning the holes of the pump holder to the pins of the boom as shown. The plunger should be clipped to the corresponding pin on the fork connector.
- 

38. Install the caps (20) as shown.
- 

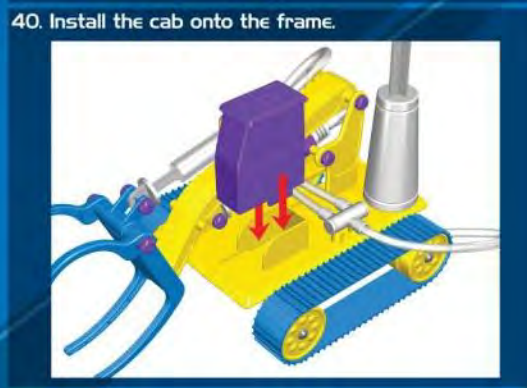
39. Combine the cab parts (6).
 40. Install the cab onto the frame.
- 
- 

41. Done! Push and pull the handle of the hand pump and note how the plunger of each mini pump controls the movement of the boom and fork of the wood loader!
- 
- Note:** If the unit is unused for some time, the mini pumps may be "stuck" and it becomes hard to push or pull the handle of the hand pump. In such case you can manually and carefully stretch the moving parts several times to reduce the friction inside the mini pumps. It will resume normal function afterwards.

