

**WARNING!**  
Not suitable for children under 36 months. Choking hazard. Only for use by children over 8 years old. To be used solely under the strict supervision of adults that have studied the precautions given in the experimental set.

Water toys sometimes get messy. Protect play surfaces before use. Drain, rinse, clean and dry all items thoroughly before storing.

Packaging materials are not toys. Please remove all packaging before giving this toy to your child.

**Did you know**  
Hydraulics is a branch of science and engineering concerned with the use of liquids to perform mechanical tasks.

Hydraulic machinery are machines and tools which use fluid power to do simple work. Heavy equipment is a common example. Excavators, cranes, wood loader, hydraulic grab, fire engine and bulldozer all make use of this principle.

Typically, the fluid used in a hydraulic system is an incompressible liquid such as water or oil. Pressure is applied by a piston to the fluid in a rigid vessel, causing the fluid to press on another piston that delivers energy to a load. If the areas of the two pistons are different, then the force applied to the first piston will be different from the force exerted by the second piston. This creates a mechanical advantage, which is the number of times a machine multiplies your effort force.

In hydraulic machine, high-pressure liquid — called hydraulic fluid — is transmitted throughout the machine to various hydraulic motors and hydraulic cylinders. The fluid is controlled directly or automatically by control valves and distributed through hoses and tubes.

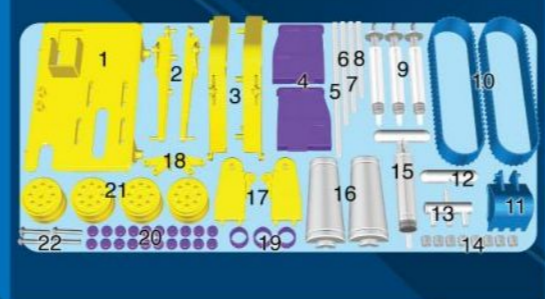
- Components:**
- |                       |                         |
|-----------------------|-------------------------|
| 1. 1 Frame            | 12. 1 Handle            |
| 2. 2 Upper boom parts | 13. 1 Flow divider      |
| 3. 2 Main boom parts  | 14. 8 Tube rings        |
| 4. 2 Cab parts        | 15. 1 Hand pump         |
| 5. Soft tube          | 16. 2 Hand pump covers  |
| 6. Soft tube          | 17. 2 Boom stand parts  |
| 7. Soft tube          | 18. 2 Bucket connectors |
| 8. Soft tube          | 19. 3 Pump holders      |
| 9. 3 Mini pumps       | 20. 20 Caps             |
| 10. 2 Tracks          | 21. 4 Wheels            |
| 11. 1 Bucket          | 22. 4 Pins              |
- 

**Assemble your Hydraulic Excavator**

1. Attach the wheels (21) to the frame (1) using the pins (22).



2. Cover the wheels with the tracks (10).



3. Combine the upper boom parts (2).



4. Attach the bucket (11) to the upper boom.



5. Attach the bucket connectors (18) to the pins of the upper boom.



6. Combine the main boom parts (3) with the upper boom.



7. Attach the boom stand parts (17) to the main boom.



8. Install the boom by inserting the boom stand to the corresponding slots on the frame.



9. Install a pump holder (19) to each mini pump.



10. Fill the mini pump by dipping its head into a cup of water and lift the plunger.



11. Point the mini pump upwards.



12. Expel the water from the mini pump by pushing the plunger all the way to the top. The tip of the mini pump should still be filled with water. Repeat steps 9-12 for all three mini pumps.



13. Install a tube ring (14) to each of the three shorter soft tubes (6,7,8).

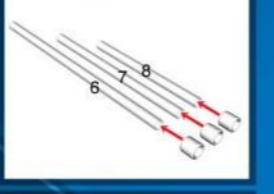

14. Attach the three tubes (6,7,8) to the flow divider (13) output marked "1", "2", "3" respectively. Secure the tubes by sliding the tube ring to the interconnection.

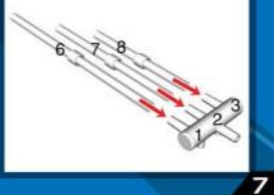

15. Attach a tube ring to the remaining soft tube (5) and connect it to the input tube of the flow divider. Secure it with the tube ring.

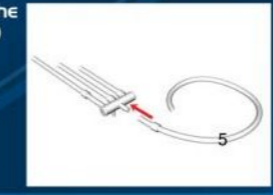

16. Attach a tube ring to the soft tubes (6,7,8).

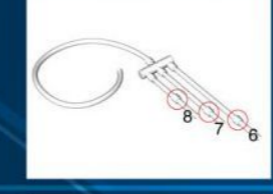

17. Connect a mini pump to the two longer soft tubes as shown.



18. Combine the handle (12) and the hand pump (15).



19. Press the handle of the hand pump to the lowest position and dip it into a cup of water.



20. Fill the hand pump with water by pulling the handle to the top.



21. Install a tube ring to the free end of the long soft tube (5). Connect the hand pump to the soft tube.

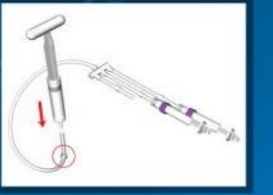

22. Press the handle of the hand pump to fill the open soft tube (8) with water.



23. Connect a mini pump to the shortest soft tube (8). Make sure no air is trapped inside the tube or the mini pump. Secure the connection with the tube ring.



24. Detach the hand pump from the soft tube.



25. Dip the pump into a cup of water again.



26. Fill the hand pump with water by pulling the handle to the top.



27. Connect the hand pump to the soft tube.



28. Detach the middle mini pump from the soft tube.



29. Press the handle of the hand pump to fill the middle soft tube (7) with water.



30. Attach the mini pump back to the soft tube. Make sure no air is trapped inside the tube or the mini pump. Secure the connection with the tube ring. Detach the hand pump from the soft tube.

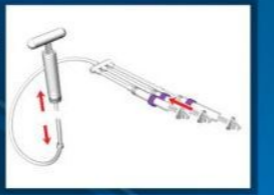

31. Dip the pump into a cup of water again.



32. Pull the handle to fill it with water.



33. Connect the hand pump to the soft tube.



34. Detach the mini pump from the longer soft tube (6).

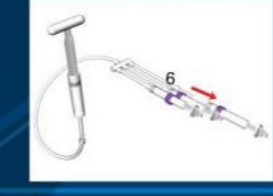

35. Press the handle of the hand pump to fill the open soft tube (6) with water.

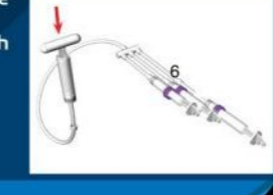

36. Attach the mini pump back to the soft tube. Make sure no air is trapped inside the tube or the mini pump. Secure the connection with the tube ring. Detach the hand pump from the soft tube.

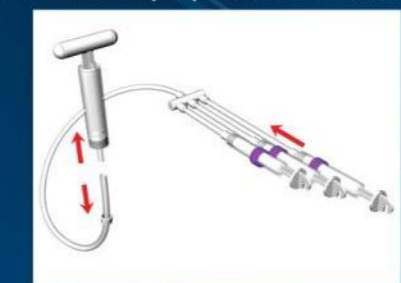

37. Dip the pump into a cup of water again.



38. Pull the handle to fill it with water.



39. Connect the hand pump to the soft tube and secure it with the tube ring at the interconnection.



40. Attach the hand pump covers (16) to the hand pump.



41. Install the flow divider onto the frame as shown.



42. Attach the hand pump to the frame.

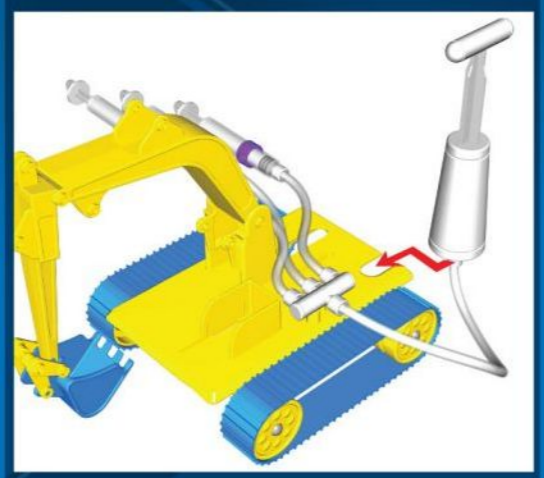

43. Install the mini pumps to the boom by aligning the holes of the pump holders to the pins of the boom and boom stand as shown. The plungers should also be clipped to the corresponding pin on the boom.

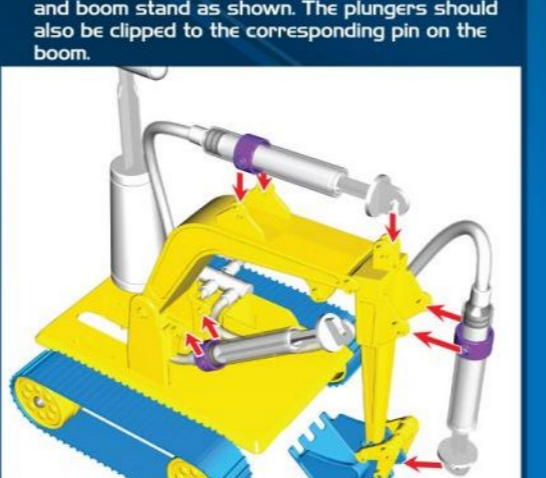

44. Install the caps (20) as shown.



45. Combine the cab parts (4).

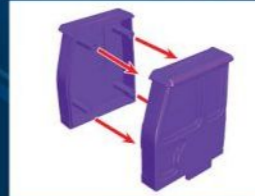

46. Install the cab onto the frame.



47. Done! Push and pull the handle of the hand pump and note how the plunger of each mini pump control the movement of the boom of the excavator!



**Note:** If the unit is unused for some time, the mini pumps may be "stuck" and it becomes hard to push or pull the handle of the hand pump. In such case you can manually and carefully stretch the moving parts several times to reduce the friction inside the mini pumps. It will resume normal function afterwards.