

Assembling your Kaleidoscope set

1. Put the bodies together.
2. Put the eyepiece onto one end of the body.
3. Slides the 3 pieces of foil mirrors into the body with the mirror facing inward.

For viewing marble

4. Place the marble holder in place and clip the marble onto the holder. Look into the eyepiece while slowly rolling the marble.

For viewing colour chips

5. Cut the colour chips into the desired shape and size.
6. Place them inside the colour chips case and put the case inside the case holder. Attached the cover to the body and it's ready for viewing.

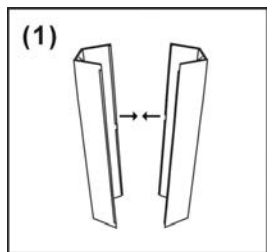

FOR VIEWING MARBLE

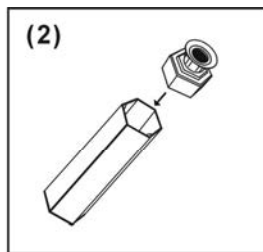

FOR VIEWING COLOR CHIPS

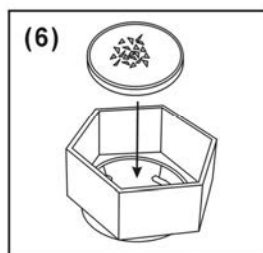
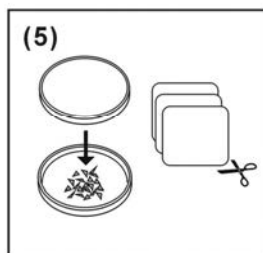
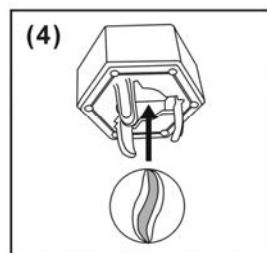
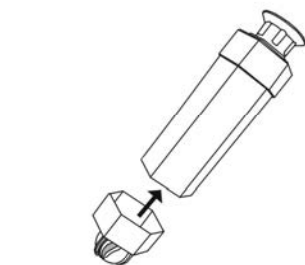
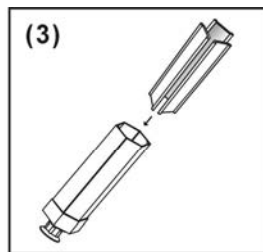

D-I-Y Kaleidoscope set

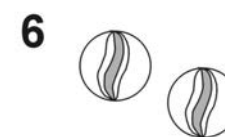
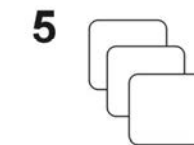
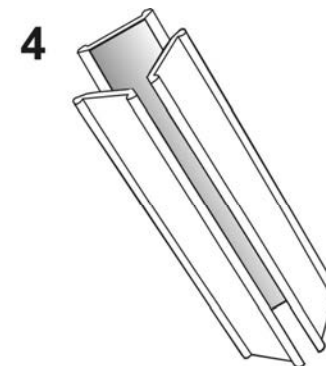
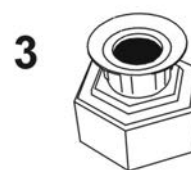
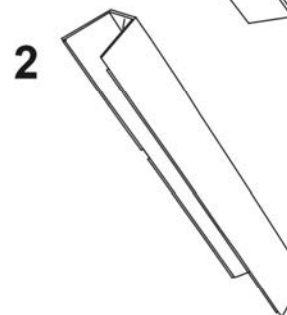
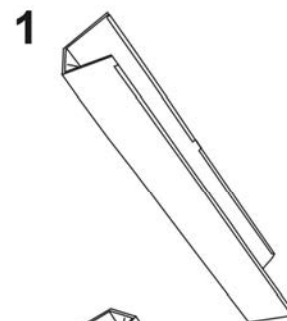

Contents include:

1. Body (left)	4. Foil mirrors x 3 pcs	7. Colour chips case
2. Body (right)	5. Colour chips x 3 pcs	8. Colour chips holder
3. Eyepiece	6. Marbles x 2 pcs	9. Marble holder