



# DeltaBoard

Fixing Instructions



# DeltaBoard

## Fixing Instructions

### Contents

#### Structure Preparation

1. DeltaBoard Surface Preparation & Fixing Overview
2. Fixing to Timber Floors
3. Fixing to Solid Floors
4. Fixing to Internal Stud Framework
5. Fixing to External Stud Framework
6. Fixing to Masonry Walls

#### Surface Preparation

7. Taping Joints, Abutments and Fixings
8. PCS Waterproofing Paste
9. Expansion/Movement Joints
10. DeltaBoard with Soft Floor Finishes  
(Carpet, Vinyl floors, Vinyl tiles, Karndean, Amtico etc)
11. DeltaBoard with Wood Planking/Laminate Planking Floor Finishes  
(Floating Floor)
12. DeltaBoard with Solid Wood Planking/Wood Blocks  
(Solid Floor)
13. DeltaBoard with Under Floor Heating
14. Tile Choice for Floors
15. Tile fixing to Walls
16. Plastering
17. Flexible Synthetic Render Systems

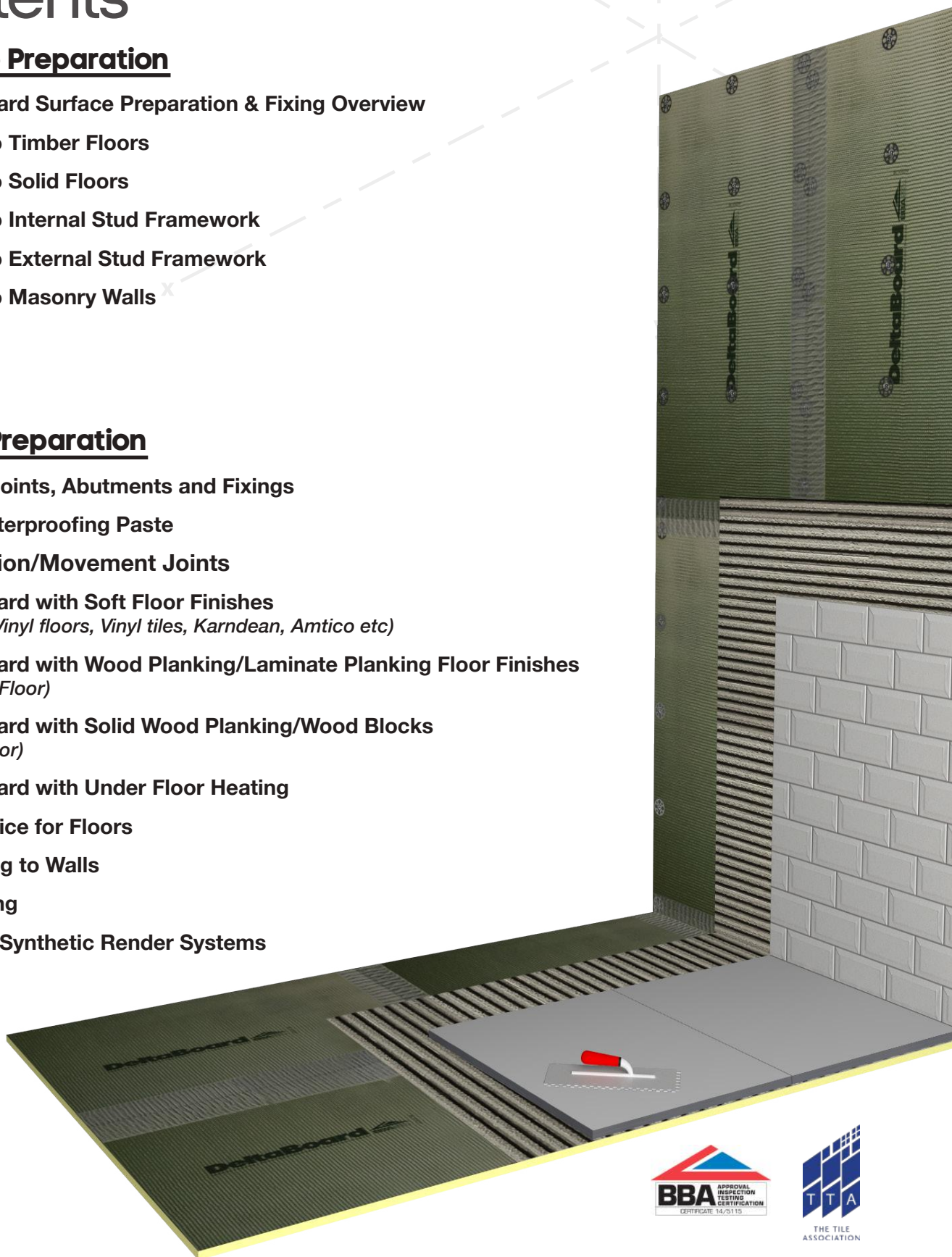

## 1. DeltaBoard Surface Preparation

**NOTE:** DeltaBoard is not compatible with solvent based adhesives.

It is very important to read the surface preparation notes set out in this document prior to installation of the DeltaBoard. The advisory points below provide a quick overview for the preparation of the DeltaBoard surface prior to applying floor finishes.

- I. For Soft floor finishes e.g. Vinyl & Carpet, it is essential to cover the DeltaBoard surface with a minimum 10mm thick, flexible, cement-based levelling screed.
- II. Wood planking and Wood Laminate can be fitted directly over the DeltaBoard surface, however, for commercial projects subject to heavy foot traffic, we recommend covering the surface of the DeltaBoard with a minimum 7mm thick, flexible, cement-based levelling screed.
- III. For Solid Wood fixed with adhesive, the surface of the DeltaBoard must be covered with a minimum 7mm thick cement-based, flexible, levelling screed.
- IV. Porcelain, natural stone and ceramic tiles, can be applied directly onto the surface of the DeltaBoard, however, for commercial projects, subject to heavy loads, we recommend covering the surface of the DeltaBoard with a minimum 7mm thick, flexible, cement-based levelling screed, prior to fixing tiles.
- V. DeltaBoard is compatible for use with highly flexible synthetic render systems. Traditional sand/cement and scraped render types are not compatible.

Refer to additional surface preparation notes set out in this document for more detailed information.

Contact PCS Technical for advice on structures, applications and surface finishes not covered in this document.

### Internal Stud Frame & Timber Floor Construction

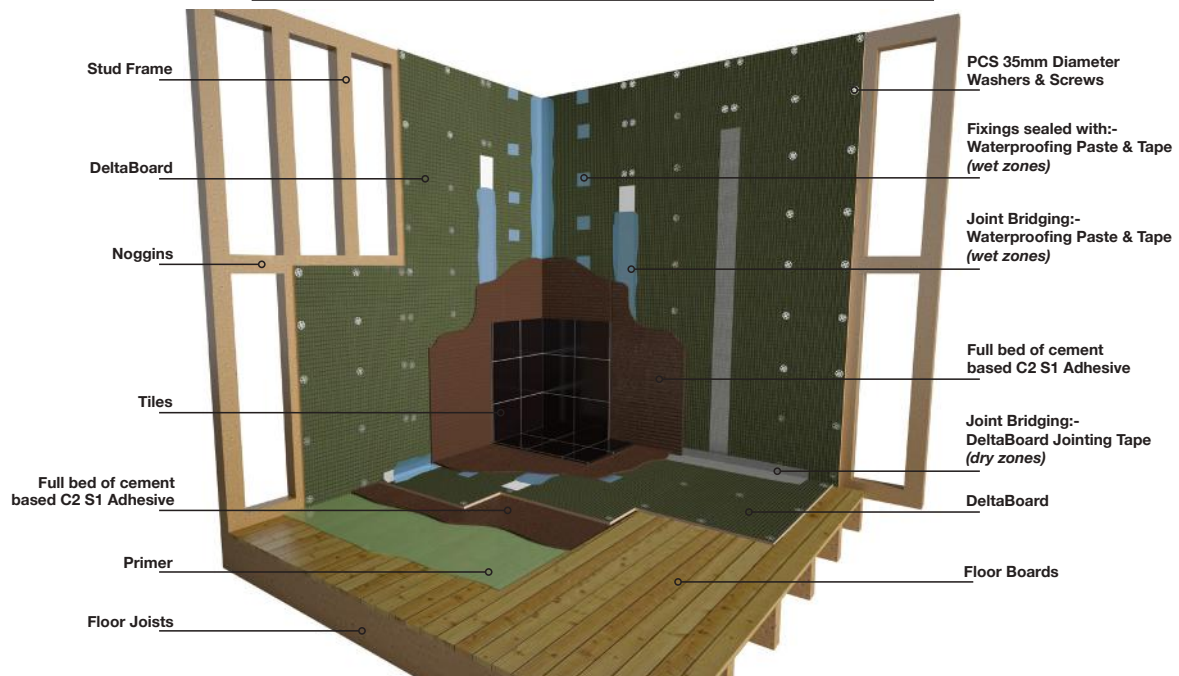

### Internal Masonry Wall & Solid Floor Construction

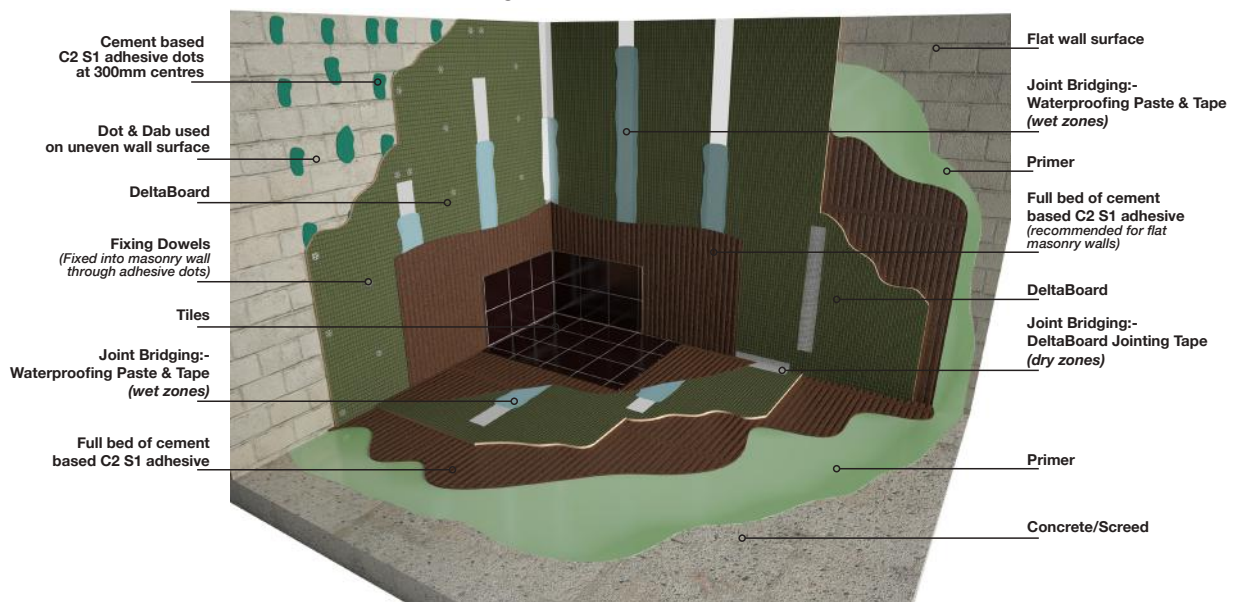

## 2. Fixing to Timber Floor Boards

### Structural Design Consideration:

DeltaBoard is NOT designed to be directly fixed onto timber joists, therefore it is essential that all joists are boarded with a suitable flooring material, such as Plywood/Chipboard Planks/T&G boarding etc. before DeltaBoard is fitted. The type of boarding used, must comply with current building regulations and approved standards. The floor boarding must be of the correct thickness to resist warping and deflection between joist centres, meet the requirements of BS EN 5385 1,2,3,4,5, code of practice for design and installation of internal floor tiling, and must be able to support the weight of finishes applied and any live loading imposed on the floor in service.

**Note:** 4mm thick DeltaBoard is not suitable for fixing onto timber floor boarding.

DeltaBoard 6mm thick and above is suitable for fixing onto timber floor boarding.

### 2a) Fixing onto timber floor boarding using cement-based tile adhesive and 35mm diameter fixing washers

*(Refer to the adhesive manufacturer's instructions for the preparation and priming of the structural boarding, prior to starting your project)*

**Note:** 4mm thick DeltaBoard is not suitable for fixing onto timber floor boarding.

DeltaBoard 6mm thick and above is suitable for fixing onto timber floor boarding.

DeltaBoard can be fixed using a good quality cement-based, flexible, fast setting tile adhesive that meets classification C2 S1 or above. Check with the adhesive manufacturer for advice on priming the floor boarding. The adhesive should be applied directly onto the floor boarding using an 8-12mm notched tiling trowel. Ensure full adhesive contact with the DeltaBoard surface; solvent-based or ready mixed adhesives must NOT be used. Fix the DeltaBoard in a brick bond style, abutting the DeltaBoard surface with adjacent DeltaBoard as you proceed. Apply pressure to the DeltaBoard surface, making sure there is good compaction of the DeltaBoard into the adhesive, and that no hollow spots remain under the DeltaBoard.

In addition to the adhesive layer, DeltaBoard must also be secured to the floor boarding with 35mm diameter fixing washers and a suitable screw with a countersunk head. Fix the washers to the DeltaBoard once the adhesive has set. It is acceptable to fix directly into the floor boarding, however, where possible fix and anchor into the floor joists. The spacing for the fixing washers should be set at 400mm - 600mm centres (e.g. 8 fixing washers per 1200mm x 600mm DeltaBoard). Position the fixing washers along the DeltaBoard edge and also down the centre line of each DeltaBoard. The fixing washers placed down the centre of the DeltaBoard should be staggered from the DeltaBoard edge fixings, creating a crisscross pattern on the DeltaBoard surface. It is acceptable to place fixing washers directly along the DeltaBoard edge, so that the fixing washers can secure adjacent DeltaBoards reducing the amount of fixings required.

Additional fixings can be used to secure the DeltaBoard firmly to the floor boarding.

**DO NOT ALLOW THE ADHESIVE TO FORM A SKIN AS THIS WILL PREVENT ADHESION.**

**NOTE: WHEN FIXING SCREWS MAKE SURE TO AVOID ELECTRICAL CABLES OR PIPEWORK THAT MAY BE CONCEALED UNDER THE FLOOR.**

#### Fixing Coverage Guide

Adhesive 4.5kg per m<sup>2</sup>

Fixings 12 per m<sup>2</sup>  
*(fixing quantities may be reduced if washers are used to span adjacent DeltaBoards)*

Indicative Fixing Detail using adhesive, washers & screws  
(1200mm x 600mm DeltaBoard)

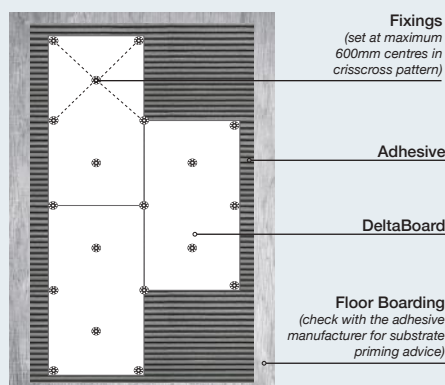

2b) Fixing onto timber floor boarding using fixing washers and screws only (no adhesive)

Note: 4mm thick DeltaBoard is not suitable for fixing onto timber floor boarding.

DeltaBoard 6mm thick and above is suitable for fixing onto timber floor boarding.

DeltaBoard can be secured directly to timber floor boarding using 35mm diameter fixing washers and suitable screws with a countersunk head, set at a maximum of 300mm centres (e.g. 15 fixings per 1200mm x 600mm DeltaBoard). It is acceptable to fix directly into the floor boarding, however, where possible fix and anchor into the floor joists. It is acceptable to place fixing washers directly along the DeltaBoard edge so that the fixing washers can secure adjacent DeltaBoard reducing the amount of fixings required. Ensure that the DeltaBoard is in full contact with the floor surface and that there is no movement, or hollow spots, between the DeltaBoard and the sub floor. Additional fixings can be used to secure the DeltaBoard firmly to the floor boarding. If the sub floor is uneven, we would recommend applying adhesive and fixing washers to secure the DeltaBoard to the sub floor (referenced in note 2a.)

**NOTE: WHEN FIXING SCREWS MAKE SURE TO AVOID ELECTRICAL CABLES OR PIPEWORK THAT MAY BE CONCEALED UNDER THE FLOOR.**

Fixing Coverage Guide

Fixings 21 per m<sup>2</sup>  
*(fixing quantities may be reduced if washers are used to span adjacent DeltaBoards)*

Indicative Fixing Details using washers & screws  
(1200mm x 600mm DeltaBoard)

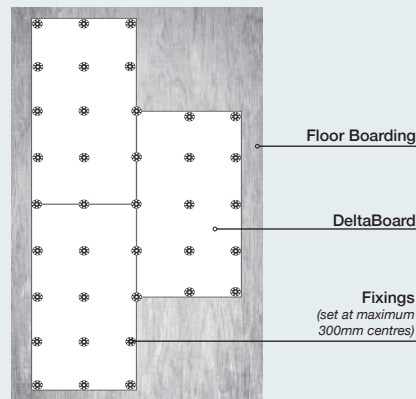

### 3. Fixing to Solid Floors

3a) Fixing onto concrete / cement screed / asphalt and other similar solid substrates using cement-based tile adhesive. For Calcium Sulphate / Anhydrite / Gypsum screeds, advice must be sought from the adhesive manufacturer regarding the preparation of the screed prior to applying fixing adhesive.

*(Refer to the adhesive manufacturer's instructions for the preparation and priming of the substrate, prior to starting your project)*

Note: DeltaBoard of all thicknesses is suitable for fixing onto solid floors.

Prior to fixing the DeltaBoard, all traces of grease and loose material must be removed from the floor substrate. Newly poured concrete and screed should be fully cured, and have a moisture reading no greater than 75% Relative Humidity (RH) as per BS5383 prior to fixing the DeltaBoard. We recommend sealing any porous floor substrate with a suitable water-resistant primer before adhesive is applied. Fix DeltaBoard using a good quality cement-based, flexible, fast setting tile adhesive that meets classification C2 S1 or above.

When fixing DeltaBoard to substrates such as Calcium Sulphate, Anhydrite, Gypsum screeds, advice must be sought from the adhesive manufacturer regarding the preparation of the screed prior to applying the adhesive. The adhesive should be applied directly onto the floor using an 8-12mm notched tiling trowel, ensuring full coverage to the DeltaBoard surface; solvent-based or ready mixed adhesives must NOT be used. Fix DeltaBoard into the adhesive in a brick bond style, abutting the DeltaBoard surface with adjacent DeltaBoards as you proceed. Apply pressure to the DeltaBoard surface making sure there is good compaction of the DeltaBoard into the adhesive, and that no hollow spots remain under the DeltaBoard.

**DO NOT ALLOW THE ADHESIVE TO FORM A SKIN AS THIS WILL PREVENT ADHESION.**

#### Fixing Coverage Guide

Adhesive	4.5kg per m <sup>2</sup>
----------	--------------------------

Indicative Fixing Details using adhesive  
(1200mm x 600mm DeltaBoard)

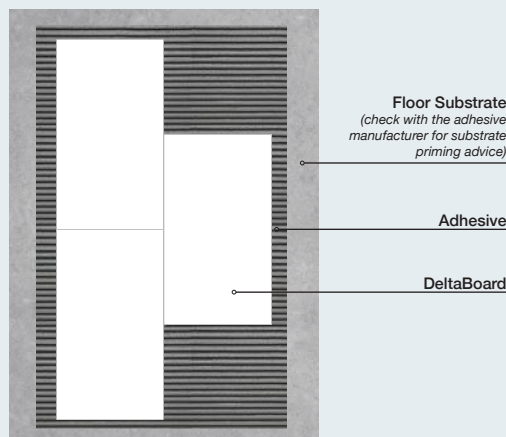

## 4. Fixing to Internal Stud Framework

### Structural design consideration:

Stud framework and any cladding/lining used, must be designed and constructed in accordance with relevant building regulations, and must be able to support the weight of the finishes applied, and any live loading imposed on the framework.

DeltaBoard over plasterboard lined stud framework is fixed using the same detail as fixing DeltaBoard over unlined studs.

DeltaBoard 4mm thick is not suitable for use onto walls.

DeltaBoard 6mm thick is not suitable for use over unlined or plasterboard lined stud framework.

DeltaBoard 6mm thick is suitable for use over plywood lined stud framework.

DeltaBoard 10mm thick and above is suitable for use over unlined and lined stud framework.

### 4a) Fixing directly onto internal stud framework and onto stud framework lined with plasterboard

*(Fix using 35mm diameter washers and screws)*

**Note:** DeltaBoard must be 10mm thick or greater for use over unlined and plasterboard lined stud framework.

For 10mm thick DeltaBoard, vertical studs should be set at maximum 300mm centres.

For 12.5mm thick DeltaBoard, vertical studs should be set at maximum 400mm centres.

For DeltaBoard above 20mm thick, stud centres should be set at maximum 600mm centres.

Timber noggins **MUST** be installed between vertical studs and positioned to support the edges of the DeltaBoard.

Fixing washers and screws should be set at maximum 300mm centres on vertical stud framework and also fixed into the intermediate noggins on 600mm stud centres (e.g. 15 fixing per 1200mm x 600mm DeltaBoard on 300mm studs, 12 fixing per 1200mm x 600mm DeltaBoard on 400mm and 600mm studs)

Additional fixings can be used if required.

#### Fixing Coverage Guide

Fixings: 21 fixings per m<sup>2</sup> based on 300mm stud centres for a 10mm thick DeltaBoard.  
*(fixing quantities may be reduced if washers are used to span adjacent DeltaBoards)*

Fixings: 17 fixings per m<sup>2</sup> based on 400mm stud centres for a 12.5 mm thick DeltaBoard.  
*(fixing quantities may be reduced if washers are used to span adjacent DeltaBoards)*

Fixings: 17 fixings per m<sup>2</sup> based on 600mm stud centres for a 20mm+ thick DeltaBoard.  
*(fixing quantities may be reduced if washers are used to span adjacent DeltaBoards)*

#### Stud Framework (unlined)

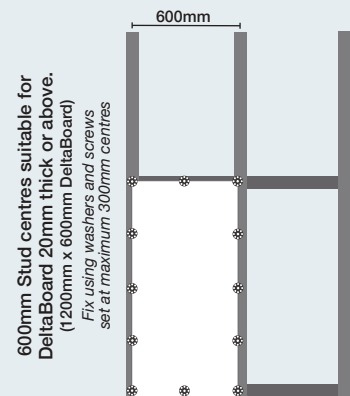
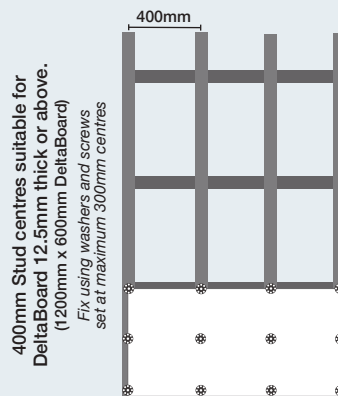
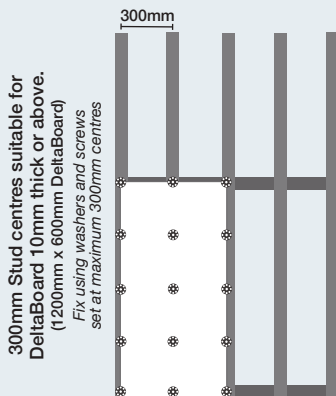

#### Stud Framework (plasterboard lined)

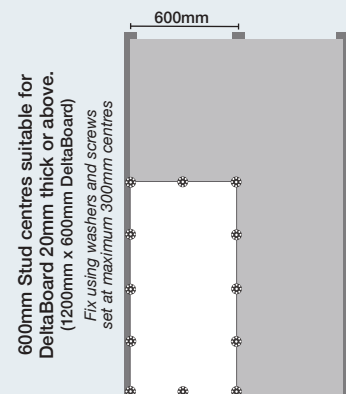
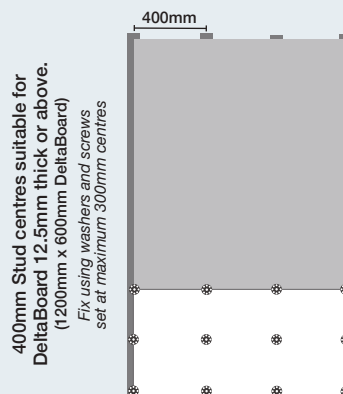
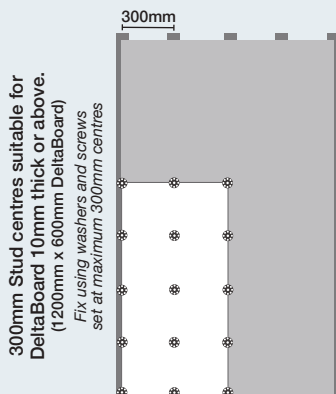

**4b) Fixing to Internal stud framework pre lined with Plywood**

*(Fix using 35mm diameter washers and screws)*

**Note:** 4mm thick DeltaBoard is not suitable for fixing onto walls

DeltaBoard 6mm thick and above can be fixed over plywood lined stud framework

Studs can be set up to 600mm centres, plywood must be minimum 12mm thick.

Fix 6mm thick DeltaBoard with washers and screws set at 200mm centres

(i.e 28 fixings per 1200mm x 600mm DeltaBoard)

Fix DeltaBoard 10mm thick and above with washers and screws set at 300mm centres

(i.e 15 fixings per 1200mm x 600mm DeltaBoard)

It is acceptable to fix directly into the plywood lining, however, where possible fixings should be anchored into the stud framing.

Additional fixings can be used if required.

**Fixing Coverage Guide**

Fixings for 6mm thick DeltaBoard: 38 fixings per m<sup>2</sup>  
*(fixing quantities may be reduced if washers are used to span adjacent DeltaBoards)*

Fixings for 10 mm thick DeltaBoard: 21 fixings per m<sup>2</sup>  
*(fixing quantities may be reduced if washers are used to span adjacent DeltaBoards)*

**6mm DeltaBoard fixed horizontally over plywood lined studs set at 400mm centres.**  
*(1200mm x 600mm DeltaBoard)*

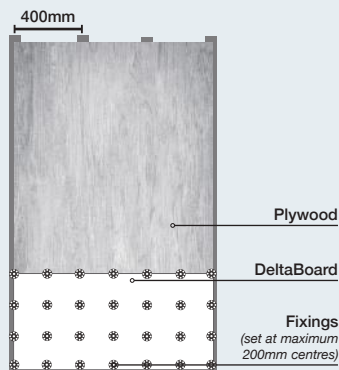

**6mm DeltaBoard fixed vertically over plywood lined studs set at 400mm centres.**  
*(1200mm x 600mm DeltaBoard)*

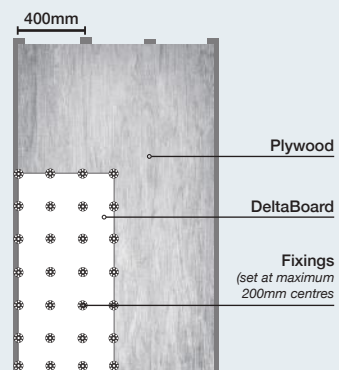

**6mm DeltaBoard fixed vertically over plywood lined studs set at 600mm centres.**  
*(1200mm x 600mm DeltaBoard)*

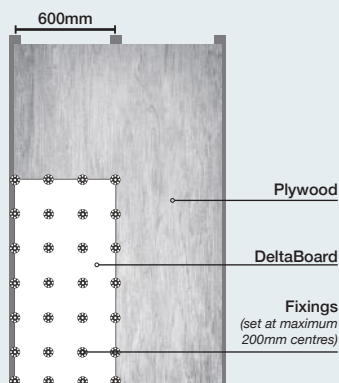

**10mm/12.5mm DeltaBoard fixed vertically over plywood lined studs set at 600mm centres.**  
*(1200mm x 600mm DeltaBoard)*

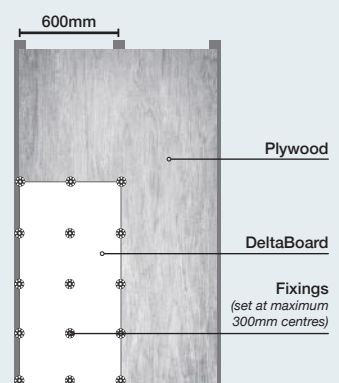



## 5. Fixing to External Stud Framework

### Structural design consideration:

DeltaBoard less than 12.5mm thick is not suitable for use onto external stud framework.

The external stud framework specification and any over cladding used must be designed and constructed in accordance with relevant building regulations. Depending on the design requirements, If the stud framework is pre clad, it may be necessary to fix 80mm wide fixing battens over the cladding, before fixing DeltaBoard to form a ventilation cavity between the DeltaBoard and the cladding. A moisture vapour membrane may also be required and must be considered as part of the design process before DeltaBoard is applied.

### 5a) External Stud Framework

*(Fix using 35mm diameter stainless- steel washers and screws)*

**Note:** DeltaBoard must be 12.5mm thick or greater for use on external stud framework

DeltaBoard should be fixed using PCS 35mm diameter stainless-steel fixing washers and stainless-steel screws with a countersunk head. Anchor fixings into the stud/batten framework.

For Stud framework with vertical studs set at 300mm centres: Use minimum 12.5mm thick DeltaBoard. Fix using 35mm diameter stainless steel washers and screws set vertically at 300mm centres. E.g. 15 Fixings per 1200mm x 600mm DeltaBoard.

For Stud framework with vertical studs set at 400mm centres: Use minimum 20mm thick DeltaBoard. Fix using 35mm diameter stainless steel washers and screws set vertically at 300mm centres. E.g. 12 Fixings per 1200mm x 600mm DeltaBoard.

For Stud framework with vertical studs set at 600mm centres: Use minimum 30mm thick DeltaBoard. Fix using 35mm diameter stainless steel washers and screws set vertically at 300mm centres. E.g. 10 Fixings per 1200mm x 600mm DeltaBoard.

#### Fixing Coverage Guide

For 300mm stud framework centres with 12.5mm thick DeltaBoard: 21 fixings per m<sup>2</sup>

For 400mm stud framework centres with 20mm thick DeltaBoard: 17 fixings per m<sup>2</sup>

For 600mm stud framework centres with 30mm thick DeltaBoard: 14 fixings per m<sup>2</sup>

#### Stud framework without cladding

Indicative Fixing Detail  
using washers & screws  
with 300mm Stud Centres  
(1200mm x 600mm x 12.5mm DeltaBoard)

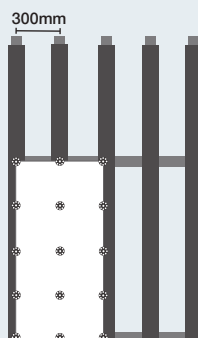

#### Stud framework with cladding & ventilation cavity

Indicative Fixing Detail  
using washers & screws  
with 400mm Stud Centres  
(1200mm x 600mm x 20mm DeltaBoard)

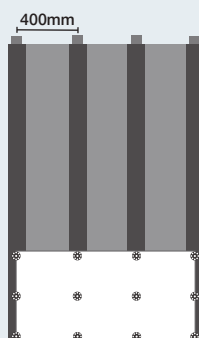

Indicative Fixing Detail  
using washers & screws  
with 600mm Stud Centres  
(1200mm x 600mm x 30mm DeltaBoard)

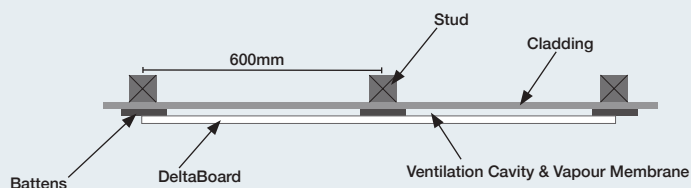
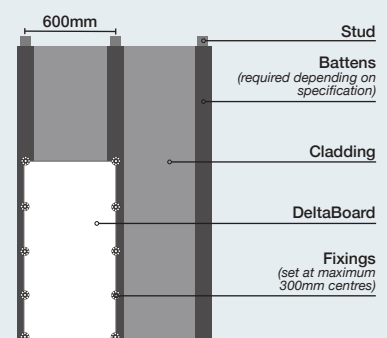

**Cross section showing cladding with ventilation cavity**

**5b) External Stud Framework Clad in Cement Panelling**

*(fix with a solid adhesive bed and secure with 35mm diameter stainless- steel washers and screws)*

**Note:** DeltaBoard must be 12.5mm thick or greater.

DeltaBoard should be fixed onto external cement panelling using a cement-based, flexible, tile adhesive that meets classification C2 S1 or above. The cement panels must be sealed with a suitable primer before cement adhesive is applied. In addition to the adhesive layer, 35mm diameter stainless-steel fixing washers and stainless-steel screws with a countersunk head must be used. The washers and screws must be fixed through the DeltaBoard and cement cladding to anchor directly into the stud framework. The fixings should be positioned at maximum 300mm centres along the vertical studs of the framework.

The adhesive should be applied directly to the panelling using an 8-12mm notched tiling trowel, ensuring full coverage of the DeltaBoard surface; solvent-based or ready mixed adhesives must NOT be used. In certain circumstances, for example uneven walls, it may be necessary to back butter the DeltaBoard in addition to the adhesive applied to the substrate. Place the DeltaBoard onto the wall surface, and bed firmly into place. Apply pressure to the DeltaBoard surface making sure there is good compaction of the DeltaBoard into the adhesive, and that no hollow spots remain under the DeltaBoard. The adhesive layer will provide additional rigidity to the DeltaBoard cladding.

Level the DeltaBoards using a straight edge to ensure a flat uniform surface is achieved. Stagger DeltaBoard joints by fixing the DeltaBoard in a brick bond style.

**Fixing Coverage Guide**

<b>Fixings</b>	21 fixings + 4.5kg adhesive per m <sup>2</sup> based on 300mm stud centres
	17 fixings + 4.5kg adhesive per m <sup>2</sup> based on 400mm stud centres
	14 fixings + 4.5kg adhesive per m <sup>2</sup> based on 600mm stud centres

**Indicative Fixing Detail**  
using adhesive, washers & screws  
based on 300mm stud centres  
(1200mm x 600mm x 12.5mm DeltaBoard)

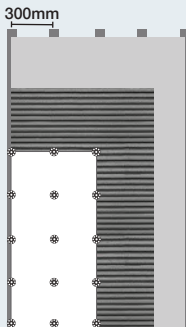

**Indicative Fixing Detail**  
using adhesive, washers & screws  
based on 400mm stud centres  
(1200mm x 600mm x 12.5mm DeltaBoard)

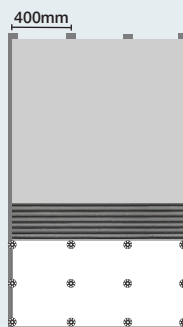

**Indicative Fixing Detail**  
using adhesive, washers & screws  
based on 600mm stud centres  
(1200mm x 600mm x 20mm DeltaBoard)

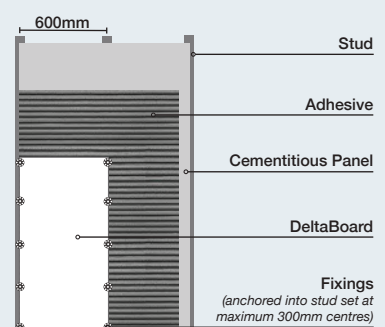

## 6. Fixing to Masonry Walls

### Structural design consideration:

To fix DeltaBoard onto walls above 2.4mtrs in height, mechanical fixing dowels and adhesive must be used.

For walls under 2.4mtrs DeltaBoard can be fixed using adhesive without the need for fixing dowels.

For masonry walls that have a plaster or cement finish, adhesive and fixing dowels must be used. Fixing dowels must be of sufficient length to securely anchor into the masonry wall by a minimum 50mm. Ensure that the wall surface is stable, free of dust and grease, and that all loose and deleterious materials are removed to ensure good adhesion between the adhesive and the wall substrate.

**Note:** 4mm thick DeltaBoard is not suitable for fixing onto walls.

DeltaBoard 6mm thick and above is suitable for solid bed fixing onto masonry walls.

#### 6a) Fixing onto Internal Masonry walls

*(Fix using a solid adhesive bed. Fixing dowels will also be required if the wall has a cement or plaster finish)*

**Note:** 4mm thick DeltaBoard is not suitable for fixing onto walls.

DeltaBoard 6mm thick and above is suitable for solid bed fixing onto masonry walls.

DeltaBoard can be fixed onto clean internal masonry walls using a cement-based, flexible, fast setting tile adhesive that meets classification C2 S1 or above. The wall surface must be sealed with a suitable primer, prior to applying the cement adhesive.

The adhesive should be applied directly onto the wall using an 8-12mm notched tiling trowel, ensuring full coverage to the DeltaBoard surface; solvent-based or ready mixed adhesives must NOT be used. In certain circumstances, for example uneven walls, it may be necessary to back butter the DeltaBoard in addition to the adhesive applied to the substrate. Place the DeltaBoard onto the wall surface, and bed firmly into place. Apply pressure to the DeltaBoard surface, making sure there is good compaction of the DeltaBoard into the adhesive, and that no hollow spots remain under the DeltaBoard.

Level the DeltaBoards using a straight edge to ensure a flat uniform surface is achieved. Stagger DeltaBoard joints by fixing the DeltaBoard in a brick bond style.

**DO NOT ALLOW THE ADHESIVE TO FORM A SKIN AS THIS WILL PREVENT ADHESION.**

#### 6b) Fixing onto Internal Masonry Walls with Gypsum/ Cement Finishes

**Note:** 4mm thick DeltaBoard is not suitable for fixing onto walls.

DeltaBoard 6mm thick and above is suitable for solid bed fixing onto masonry walls.

For internal masonry walls that have a gypsum or cement finish and is in a good condition, it may be possible to fix the DeltaBoard onto the wall without removing the existing finishes; however professional advice on the stability of the wall structure and wall finishes should be sought. All masonry, cement, and gypsum wall surfaces must be sealed with a suitable primer, prior to applying the cement adhesive.

Fix DeltaBoard over the cement/plaster finishes using a flexible, fast setting tile adhesive that meets classification C2 S1 or above. The adhesive should be applied to the wall surface using an 8-12mm notched tiling trowel, ensuring full coverage of the DeltaBoard surface; solvent-based or ready mixed adhesives must NOT be used. In certain circumstances, for example uneven walls, it may be necessary to back butter the DeltaBoard in addition to the adhesive applied to the substrate.

In addition, once the adhesive has set, DeltaBoards MUST be fixed with PCS fixing dowels set at 400mm - 600mm centres (e.g. 8 dowels per 1200mm x 600mm DeltaBoard).

Position the fixing dowels along the DeltaBoard edge and also along the centre line of each DeltaBoard. The fixings placed along the centre of the DeltaBoard should be staggered from the DeltaBoard edge fixings, creating a crisscross pattern on the DeltaBoard surface.

Additional fixings can be used to secure the DeltaBoard firmly to the wall substrate.

**DO NOT ALLOW THE ADHESIVE TO FORM A SKIN AS THIS WILL PREVENT ADHESION.**

#### Fixing Coverage Guide

Adhesive: 4.5kg per m<sup>2</sup>

Fixings Dowels: 12 per m<sup>2</sup>

*(fixing quantities may be reduced if Dowels are used to span adjacent DeltaBoards)*

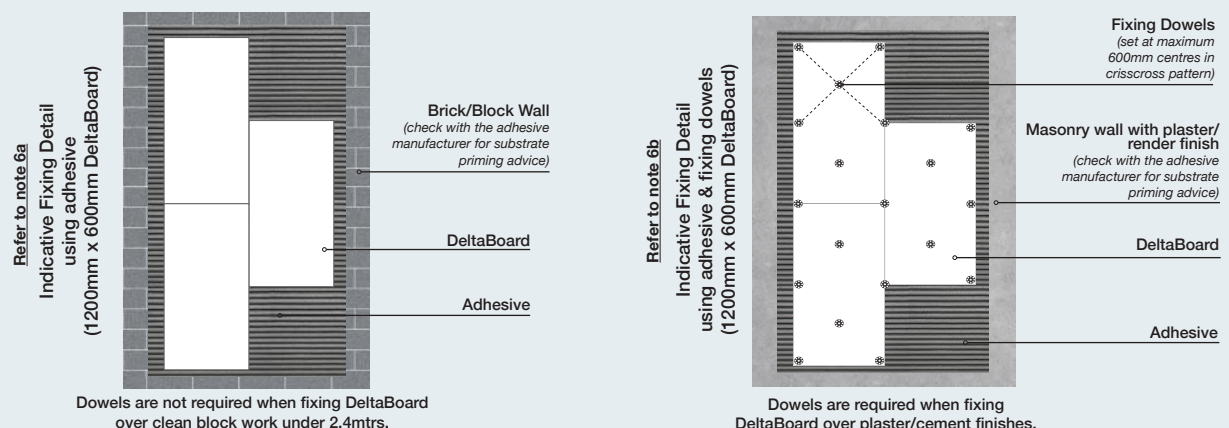

### 6c) Fixing onto External Masonry walls

*Fix using a solid adhesive bed and secure with fixing dowels)*

To fix DeltaBoard onto walls above 2.4mtrs in height, mechanical fixing dowels and adhesive must be used.

For walls under 2.4mtrs DeltaBoard can be fixed using adhesive without the need for fixing dowels.

Fixing dowels must be of sufficient length to securely anchor into the masonry wall by a minimum 50mm.

Ensure that the wall surface is stable, free of dust and grease, and that all loose and deleterious materials are removed to ensure good adhesion between the adhesive and the wall substrate.

**Note:** 4mm thick DeltaBoard is not suitable for fixing onto walls.

DeltaBoard 6mm thick and above is suitable for solid bed fixing onto masonry walls.

DeltaBoard can be fixed onto clean external masonry walls using a solid bed of cement-based, flexible, tile adhesive that meets classification C2 S1 or above. When Fixing DeltaBoard onto external masonry walls that extend above 2.4mtrs height, in addition to the solid adhesive bed, the DeltaBoard must also be secured with fixing dowels once the adhesive has set. Fixing dowels should be set at 400mm and 600mm centres (e.g. 8 fixings per 1200mm x 600mm DeltaBoard). Seal the wall with a suitable water-resistant primer, before the adhesive is applied. The adhesive should be applied directly onto the wall using an 8-12mm notched tiling trowel, ensuring full coverage to the DeltaBoard surface; solvent-based or ready mixed adhesives must NOT be used. In certain circumstances, for example uneven walls, it may be necessary to back butter the DeltaBoard in addition to the adhesive applied to the substrate.

Place the DeltaBoard onto the wall surface, and bed firmly into place. Apply pressure to the DeltaBoard surface, making sure there is good compaction of the DeltaBoard into the adhesive, and that no hollow spots remain under the DeltaBoard. Level the DeltaBoards using a straight edge to ensure a flat uniform surface is achieved. Stagger DeltaBoard joints by fixing the DeltaBoard in a brick bond style. Position the fixing dowels (required above 2.4mtrs) along the DeltaBoard edge and also along the centre line of each DeltaBoard. The fixings placed along the centre of the DeltaBoard should be staggered from the DeltaBoard edge fixings, creating a crisscross pattern on the DeltaBoard surface.

Additional fixings can be used to secure the DeltaBoard firmly to the wall substrate.

**DO NOT ALLOW THE ADHESIVE TO FORM A SKIN AS THIS WILL PREVENT ADHESION.**

<b>Fixing Coverage Guide</b>
Adhesive: 4.5kg per m <sup>2</sup>
Fixings: 12 per m <sup>2</sup> <i>(fixing quantities may be reduced if washers are used to span adjacent DeltaBoards)</i>

**Indicative Fixing Detail  
using adhesive and fixing dowels.  
(1200mm x 600mm DeltaBoard)**

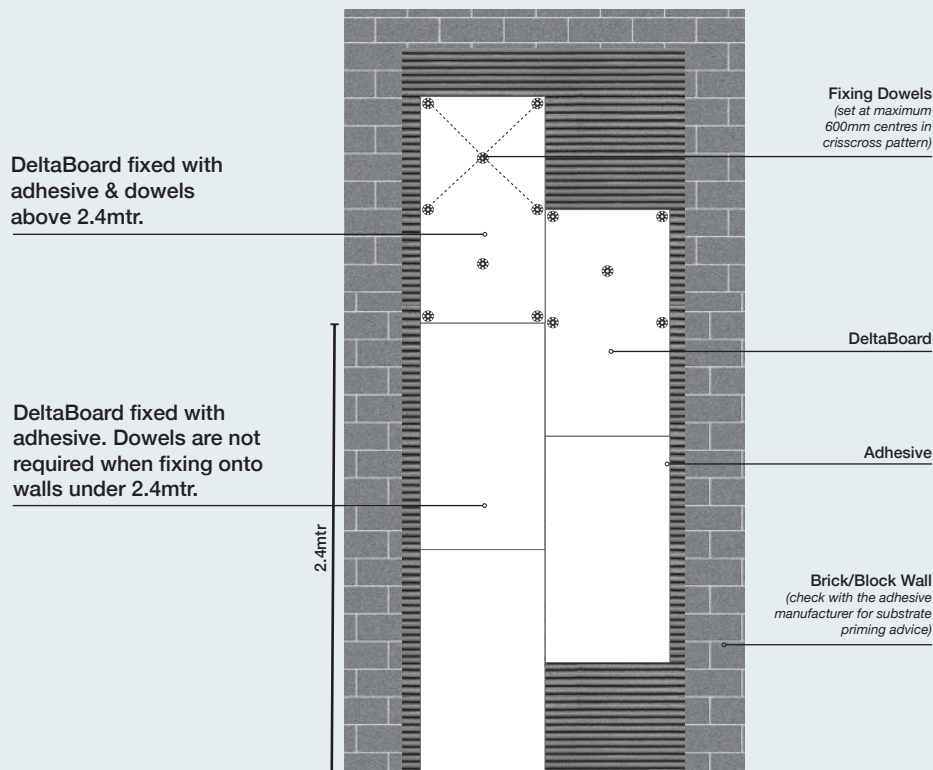

**6d) Dot and Dab onto Masonry Walls (internal walls only)**

*(fix with cement-based adhesive dots and secure with fixing dowels. DRYWALL ADHESIVE MUST NOT BE USED.*

**Note:** DeltaBoard must be 12.5mm thick or greater for fixing with Dot and Dab method.

Make sure that the existing wall surface is stable and free of dust and grease. If the wall has a pre-finished surface e.g. plaster/render, and is in a good condition, it may be possible to adhere the DeltaBoard without removing the existing finish, however professional advice on the stability of the existing finishes and wall structure should be sought. All masonry walls, and cement and plaster finishes must be sealed with a suitable primer before cement adhesive is applied. To fix DeltaBoard to walls, the dot and dab material used, must be cement-based, flexible, fast setting tile adhesive that meets classification C2 S1 or above.

The adhesive dots must be applied directly to the DeltaBoard with dots set at a maximum 300mm apart. A useful tip is to create a pre-set hole through the face of the DeltaBoard to show where the fixing dowels will be placed once adhesive has set. To avoid adhesive shrinkage, the tile adhesive dots must not exceed 15mm once compressed to the wall substrate. Place the DeltaBoard onto the wall surface, and bed firmly into place in a brick bond style, levelling the DeltaBoard surface with adjacent DeltaBoard as you proceed. Apply pressure to the DeltaBoard surface making sure there is good compaction of the DeltaBoard onto the wall. In addition to the adhesive dots, DeltaBoards must be secured using fixing dowels anchored with a minimum 50mm embedment into the masonry wall. Position the dowels through the centre of the adhesive dots once the adhesive has set.

Place dowels at between 400mm and 600mm centres (e.g. 8 fixings per 1200mm x 600mm DeltaBoard). Position the fixing dowels along the DeltaBoard edge and also down the centre line of each DeltaBoard. The fixing dowels placed down the centre of the DeltaBoard should be staggered from the DeltaBoard edge dowels, creating a crisscross pattern on the DeltaBoard surface.

Additional fixings can be used to secure the DeltaBoard firmly to the wall substrate.

Fixing Coverage Guide	
Adhesive	6kg per m <sup>2</sup>
Fixings	12 per m <sup>2</sup>

**Indicative Fixing Detail  
using adhesive dots and fixing dowels  
(2400mm x 600mm DeltaBoard)**

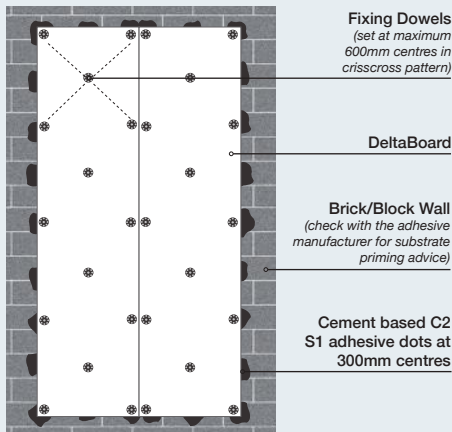

**Indicative Fixing Detail  
using adhesive dots and fixing dowels  
(1200mm x 600mm DeltaBoard)**

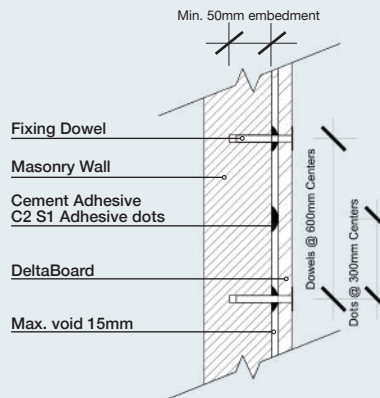
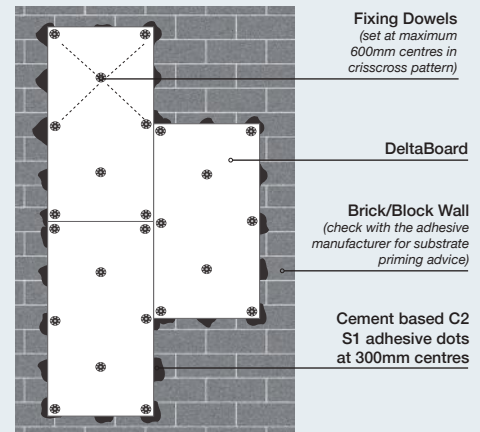

**Cross section showing dowels fixed through adhesive dots.**

## 7. Taping Joints, Abutments and Fixings

All DeltaBoard joints, abutments and mechanical fixings must be bridged with a joint reinforcing tape, suitable for the intended use and the environment in which the DeltaBoard is to be installed.

For DeltaBoard fixed in dry zones: Tape all joints, fixing washers, and holes in the DeltaBoard using an alkaline resistant mesh such as DeltaBoard Jointing Tape.

For DeltaBoard fixed in wet zones: Tape all joints, fixing washers, and holes in the DeltaBoard with PCS Waterproofing Paste and PCS Waterproofing Tape.

PCS Waterproofing Paste is a brush applied liquid waterproofing membrane designed for use under tiles. Tiles should be fixed over PCS Waterproofing Paste & Tape using a cement-based tile adhesive that meets classification C2 S1 or above. Solvent based, ready mixed and epoxy-based adhesives should not be used over the PCS Waterproofing Paste and Tape.

Solvent free epoxy grout, that meets classification R2, can be used to grout tiles that have been fixed over PCS Waterproofing Paste with a cement based C2 S1 adhesive.

## 8. PCS Waterproofing Paste

Although DeltaBoard is 100% waterproof, moisture vapour can pass through the DeltaBoard structure, when exposed to extremely high humidity over prolonged periods in environments such as steam rooms. To protect the DeltaBoard against moisture vapour penetration in such harsh environments, we recommend applying PCS Waterproofing Paste over the entire surface of the DeltaBoard. Covering all joints, abutments and fixings with PCS Waterproofing Paste & Tape, will provide an effective vapour barrier with a moisture resistance value of  $\mu 41400$ , prior to fixing tiles.

Domestic showering and bathing environments are not usually subject to prolonged high levels of humidity, and therefore, only require the board joints and fixings to be covered with PCS Waterproofing Paste and Tape. PCS Waterproofing Paste is very easy to apply using a paint brush or roller. The instruction guidance supplied with the PCS Waterproofing Paste must be followed.

PCS Waterproofing Paste is designed for use under tiles. Tiles should be fixed over the PCS Waterproofing Paste and Tape using a cement-based tile adhesive that meets classification C2 S1 or above. Solvent based, ready mixed and epoxy-based adhesives should not be used over the PCS Waterproofing Paste. Solvent free epoxy grout, that meets classification R2, can be used to grout tiles that have been fixed over PCS Waterproofing Paste with a cement based C2 S1 adhesive.

## 9. Expansion/Movement Joints

DeltaBoard must not bridge expansion/movement joints. The integrity of such joints should be maintained through the DeltaBoard and tile bed and should be sealed in the appropriate manner.

## 10. DeltaBoard with Soft Floor Finishes

*(Carpet, Vinyl floors, Vinyl tiles, Karndean, Amtico etc)*

When installing soft floor coverings over DeltaBoard, it is essential that the surface of the DeltaBoard is covered with a minimum 10mm thick hard-wearing, cement-based, flexible, levelling screed, capable of resisting high point loading. Tape all DeltaBoard Joints before applying the levelling screed. The cement levelling screed must be left to cure before floor finishes are applied.

**Note:** DeltaBoard is not compatible with solvent based adhesives. If solvent adhesive is required to fix floor finishes over DeltaBoard, the surface of the DeltaBoard must be covered with a cement based, flexible, levelling screed, applied at a minimum thickness of 7mm. For floor finishes where solvent based adhesive is to be used, care must be taken to ensure that the solvent adhesive does not come into contact with the DeltaBoard.

## 11. DeltaBoard with Wood Planking/Laminate Planking Floor Finishes (*Floating Floor*)

For domestic projects, if the floor is flat and level wood planking/laminate planking can be fitted directly over DeltaBoard.

Lay the wood planking/laminate planking after fitting a foam underlay over the surface of DeltaBoard. The type of underlay used will depend on the type of wood planking/laminate planking used. It is important to use a low thermal resistant underlay if underfloor heating is present.

When installing wood planking/laminate planking over DeltaBoard on commercial projects, the DeltaBoard surface must be covered with a minimum 7mm thick, hard-wearing, cement-based, flexible, levelling screed, capable of resisting high point loading.

Tape all Board Joints before applying the levelling screed. The cement levelling screed must be allowed to cure before floor finishes are applied.

## 12. DeltaBoard with Solid Wood Planking/Wood Blocks fixed using Adhesive (Solid Floor)

When fixing Solid Wood finishes over DeltaBoard, the surface of the DeltaBoard must be covered with a minimum 7mm thick hard-wearing, cement-based, flexible, levelling screed, capable of resisting high point loading. The cement screed must be allowed to cure before floor finishes are applied. Fix the Solid Wood onto the levelling screed in accordance with the solid wood manufacturer's instructions.

**Note:** DeltaBoard is not compatible with solvent based adhesives. If solvent adhesive is required to fix floor finishes over DeltaBoard, the surface of the DeltaBoard must be covered with a cement based, flexible, levelling screed, applied at a minimum thickness of 7mm. For applications where solvent based adhesive is to be used, care must be taken to ensure that the solvent adhesive does not come into contact with the DeltaBoard.

## 13. DeltaBoard with Under Floor Heating

DeltaBoard is a thermally insulating construction board, and when installed below underfloor heating will improve the heating system performance by significantly reducing downward heat loss. DeltaBoard is compatible for use with water based and electric cable underfloor heating systems. DeltaBoard must not be fixed over floors that have an existing underfloor heating system installed.

## 14. Tile Choice for Floors

When choosing tiles for your floor it is important to consider point loading. Applying larger tiles improves the DeltaBoards resistance to concentrated loads. For areas that may be subject to concentrated loads over 0.21 N/mm<sup>2</sup>, advice should be sought to determine suitability. All tiles must be fixed using a solid bed of adhesive, ensuring no voids remain under the tiles. Tiles should be fixed using good quality, flexible cement-based tile adhesive that meets classification C2 S1 grade or above. Solvent-based or Ready Mixed adhesives MUST NOT be used. The chart below shows resistance to concentrated loads based on a 1mm deflection over a range of standard tile sizes.

Indicative Tile Size Examples	300mm x 200mm	150mm x 150mm	100mm x 100mm	50mm x 50mm
Load Resistance Over Tile Surface	1260kg	472kg	210kg	52.5kg

## 15. Tile fixing to Walls

Tiles can be fixed directly to DeltaBoard using a good quality cement-based, flexible tile adhesive that meets classification C2 S1 grade or above. Solvent-based or ready mixed adhesives MUST NOT be used.

Advice from the tile manufacturer must be sought regarding the mechanical securing and fixing of tiles onto walls above 2.4mtr.

## 16. Plastering

All joints, abutments and fixings, must be bridged with a suitable joint reinforcing mesh such as DeltaBoard Jointing Tape. Prior to skim coating with plaster, the surface of the DeltaBoard must be sealed using a suitable primer, applied in accordance with the manufacturer's instructions.

## 17. Flexible Synthetic Render Systems

DeltaBoard is compatible for highly flexible synthetic render systems that require the application of a reinforcing base layer and a reinforcing mesh, before a final finishing coat is applied. Traditional sand & cement-based materials, and modern one coat scraped render systems are not compatible for use with DeltaBoard.

Advice and guidance must be sought from the manufacture regarding the preparation of the DeltaBoard before applying external render.

**NOTE:** DeltaBoard must be stored flat at all times, leaning the DeltaBoard against a wall can cause them to warp slightly prior to installation. If this occurs, they can be straightened by applying a minimal amount of hand pressure. This correction will not affect the performance of the DeltaBoard. When fixing DeltaBoard in conditions where temperatures can fluctuate considerably it will be necessary to protect the boards from extreme temperature fluctuations, allowing any adhesive used to set properly. All information is given as guidance, and if adhered to will perform as intended. We fully guarantee the quality of DeltaBoard, but as we do not have knowledge of site conditions or the capability of the installer, we cannot accept liability for damage which may arise as a result of installation. The information supplied in this document covers standard applications. For application methods not covered in this document we recommend contacting PCS Technical for further advice.

The Professionals Choice



PCS Ltd  
Hemfield Court, Makerfield Way,  
Ince, Wigan, WN2 2PR

**Tel:** +44 (0) 1942 820131

**Web:** [www.pcsboard.com](http://www.pcsboard.com)