

**MOVE
TO A
BRIGHTER
WORLD**

Lighting Business Unit
ORIENT ELECTRIC LIMITED
C-130, Sector-63, Noida-201301,
U.P, India

Head Office
ORIENT ELECTRIC LIMITED
240, Okhla Industrial Estate Phase III
New Delhi-110020

Fans | Home Appliances | Lighting | Switchgear

Website: www.orientelectric.com | Email: customercare_lighting@orientelctric.com | Orient Helpline No: 18001037574 | Customer Care: 91-120-4894900 | Follow us on | [f](#) [t](#) [in](#)

Professional Luminaires Catalogue-2021

OUR JOURNEY

SEVEN DECADES OF TRUST, INNOVATION & EXCELLENCE

We started our journey more than 70 years ago, manufacturing and distributing highly efficient, premium quality fans. Since then, we have grown, embracing new frontiers in technology and innovation, to become one of the leading consumer electrical brands in India. Today, we are the largest manufacturer and exporter of fans from India with a dominating global presence in over 35 international markets. In the domestic market, we enjoy a robust pan-India reach, with over 1 lakh retail outlets and a service network covering 300 cities aided by a 24x7 call center. Not only this, we have also paved the way for pioneering developments in fans, home appliances, lighting and switchgear. We take pride in our R&D capabilities, spirit of continuous innovation and commitment to manufacturing cutting-edge lifestyle electrical products that meet the needs and expectations of modern consumers. We've always strived to achieve and exceed industry benchmarks in quality and processes through constant evolution and rejuvenation. As always, we'll continue to partner our customers at every stage of their lives by offering superior lifestyle solutions with technology that makes their world safer, easier and creatively inspiring. Orient Electric offers a diverse variety of lighting solutions apart from its equally diverse range of fans and home appliances. Advancing with modern requirements, the brand constantly upgrades to newer technologies. These, being low on cost and more efficient, are used for industrial lighting and outdoor, and also for specialised lighting requirements. With the power of the most futuristic and smartest lighting solutions, it's so easy to switch to smart.

OUR JOURNEY

FELICITATIONS THAT SPUR US ON

Orient Electric and its efforts towards excellence have been lauded by several awards and accolades. Here is a look at some of the most prominent ones.

Superbrand, 2016 & 2017

Orient Electric was named a 'Superbrand' two times in a row in Consumer Durable category in 2016 & 2017.

ASSOCHAM's Corporate Excellence Award, 2016

Orient Electric received the award for The 'Comeback Brand' in the consumer durables category at the ASSOCHAM National Brand Summit & Excellence Awards in 2016. The prestigious awards felicitate Indian brands working in various sectors towards excellence and innovation.

Make in India Award for Excellence, 2015

Orient Electric bagged the prestigious 'Make in India Award for Excellence' in the consumer electrical products category in 2015. The 'Make in India Awards for Excellence' recognise contributions that enable India to become a leading global economy.

Most Trusted Brand, 2015

Orient Electric earned the status of being one of India's most trusted brands in 2015, as per a Nielsen survey. It was listed in the consumer durables category in the Most Trusted Brand Survey report.

Global Quality Award, 2015

Orient Electric bagged the prestigious 'Global Quality Award' for the quality energy-efficient lighting products Manufacturer of the Year in 2016. The 'Global Quality Awards' recognise doers and pioneers across the manufacturing sector in India.

Icon of the Year, 2015

Orient Electric won the 'Icon of the Year' award in the lighting & switchgear category in 2015. The Brands Academy 'Icon of the Year' Awards are given to select individuals, brands and organisations to recognise their outstanding contributions to the economic growth of India.



WHY ORIENT ?

A pioneer of innovation in lighting and more, Orient is a name you can always put your trust in.

- Orient Electric offers a wide range of lighting products, from LED lighting and fixtures to energy-efficient light bulbs, batten and tube lights, as well as consumer and professional luminaires.
- Smart lighting at Orient Electric stands for four P's: People, Power, Planet and Performance. Our LED lighting solutions comply with photobiological safety norms and are environment-friendly, save energy, and perform even in trying temperature conditions, from cold storages to boiler rooms.
- Orient Electric provides lighting solutions for the professional and consumer segments, catering to commercial, industrial and residential needs.
- Orient Electric operates major manufacturing facility in Noida (Uttar Pradesh).
- Orient Electric has a wide network made up of 500 distributors and over 50,000 direct/indirect retail shops, efficiently serviced by 20 company depots across India.
- Orient Electric is one of the first companies in India to receive a 3-star BEE rating for all the wattages. It's also the only brand to have a 5-star rating for selected wattages.
- Orient Electric is the first company to launch Flicker Controlled Lights with their EyeLuv.
- Orient Electric is a regular and prominent supplier of various LED lights to the Indian government through Energy Efficiency Services Limited (EESL).

1-16

EYELUV LIGHTING

17-52

INDOOR LIGHTING

53-60

RETAIL LIGHTING

61-78

INDUSTRIAL LIGHTING

79-92

OUTDOOR LIGHTING

93-102

SOLAR LIGHTING

103-124

LANDSCAPE LIGHTING

**FLICKER IN LED
LIGHTS IS NOT
VISIBLE.
BUT IT AFFECTS
EYE HEALTH.**

eyeLuv
Flicker-Control Technology

orient
electric



Presenting

eyeLuv
Flicker-Control Technology



RECOMMENDED BY
INDIAN MEDICAL ACADEMY
FOR PREVENTIVE HEALTH

Orient EyeLuv LED lights come with Flicker-Control Technology that reduces the impact of LED flicker and its effects, like eye strain and eye fatigue, making them better and safer for overall eye health.

YOUR LED LIGHTS HAVE FLICKER THAT IS NOT VISIBLE.



Flicker is the constant fluctuation of light output. It can be divided into two kinds: Visible and Invisible. While Visible Flicker can be seen with your eyes, Invisible Flicker is at a high frequency and therefore not visible to the naked eye.

HOW DOES LED LIGHTS' FLICKER AFFECT YOU ?

- Blurred vision and eye strain
- Reduced visual task performance
- Apparent slowing or stopping of motion
- Epileptic seizure and other neurological problems
- Headache, migraine, fatigue and distraction
- Leading to lack of concentration

DECREASES PERFORMANCE AND PRODUCTIVITY

IT'S INVISIBLE. BUT HERE'S HOW TO CHECK THE FLICKER

- 1 Open your smartphone camera in slow-motion video mode.
- 2 Point the camera towards the lights & check for flicker.



Presenting | **orient electric** | **eyeLuv** Flicker-Control Technology

Orient EyeLuv LED Lights come with the revolutionary FCT (Flicker-Control Technology), which reduces the harmful invisible flicker present in LED lighting sources that causes eye strain, eye fatigue and many other health complications, thus making them better and safer for overall eye health.

- 👁️ Good for eye health
- 💡 High lumen efficacy
- ∞ Long life
- 💡 Substantial energy saving

Low flicker toh **No fikar**



POWERLINE FC

Ultra bright LED retrofit tube light aluminium housing with powder coating and polycarbonate diffuser with high efficacy, suitable for replacement of existing T8 & T12 fluorescent tube light with G13 lamp holder and revolutionary Flicker-Control Technology to reduce harmful invisible flicker present in LED lighting sources.

PRODUCT SPECIFICATIONS

Housing

Elegantly designed aluminium housing polycarbonate end caps are snap-fitted to the housing.

Optics

Polycarbonate diffuser to provide glare-free uniform light distribution. High lumen efficacy LED with viewing angle of 120° used to enhance the lumen output.

Mounting

Directly installed in existing T8/T12 FTL conventional lighting fixtures; refer to the wiring diagram for proper installation.

Control Gear

Powered by an integral constant-current driver suitable for 120-280 V AC working range.

Surge Protection

Up to 2.5 KV

IP

20

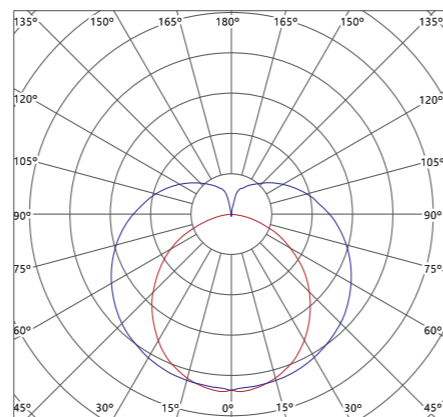

Front View

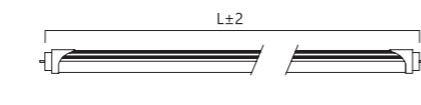

Side View

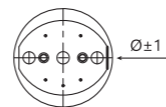

WIRING DIAGRAM

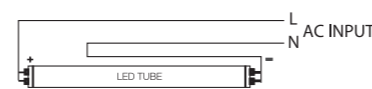

RECOMMENDED USAGE

• Commercial Buildings • Residential Buildings • Other Indoor Applications

TECHNICAL DETAILS

Model No.	System Wattage	CCT	CRI	Rated Voltage	Power Factor	Dimensions (in mm)	
						L	Ø
LTPS-18-C-FC	18W	6500K	≥80	240V AC	≥0.9	1212	32.5

CCT's are available in Cool white, Neutral white & Warm white.

TASKLINE FC

Slim LED batten with polycarbonate round-shape diffuser, Polycarbonate housing is an ideal replacement solution for existing battens/fluorescent lamps with elegantly designed end caps with revolutionary Flicker-Control Technology to reduce harmful invisible flicker present in LED lighting sources.

PRODUCT SPECIFICATIONS

Housing

Made of ultra-slim co-extruded polycarbonate channel with the housing part in white finish & diffuser part in opal finish. White- finish ABS end caps with decorative circular polycarbonate cap snap-fitted on the end cap to enhance the aesthetic of the fixture.

Optics

Polycarbonate diffuser to provide glare-free uniform light distribution. High lumen efficacy LED with viewing angle of 120° used to enhance the lumen output.

Mounting

Fix directly into the wall/ceiling by means of mounting SS clips provided with the fixture.

Control Gear

Integral electronic driver with Output Short-Circuit Protection/Open Circuit Protection, Surge Voltage Protection and other safety tests.

Surge Protection

Up to 2.5 KV

IP

20

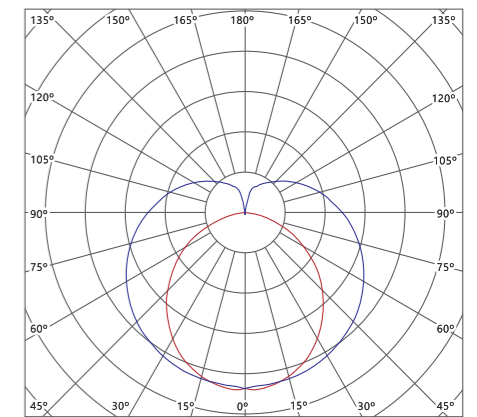

Front View

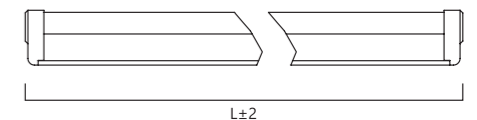

Side View

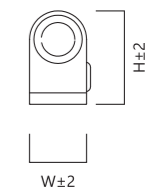

RECOMMENDED USAGE

• Commercial Buildings • Residential Buildings • Other Indoor Applications

TECHNICAL DETAILS

Model No.	System Wattage	CCT	CRI	Rated Voltage	Power Factor	Dimensions (in mm)		
						L	W	H
LBLN-18-C-FC	18W	6500K	≥80	240V AC	≥0.9	1183	21.5	36.5

CCT's are available in Cool white, Neutral white & Warm white.

VENUS PLUS FC

Recess backlit downlighter round with heat dissipating fins for larger surface area finished in epoxy powder coated white to deliver high efficacy light output and uniformity utilising back lit technology and revolutionary flicker- control technology that reduce harmful invisible flicker present in LED lighting sources.

PRODUCT SPECIFICATIONS

Housing

Designed in round shape with excellent thermally managed aluminium pressure die cast housing.

Optics

High transmittance opal diffuser for glare free symmetric light distribution.

Mounting

Fix into false ceiling by means of spring & clips provided.

Control Gear

Powered by an independent electronic LED driver with Output Short-circuit protection, Surge protection & other reliability tests.

Surge Protection

Up to 2.5 KV

IP

20

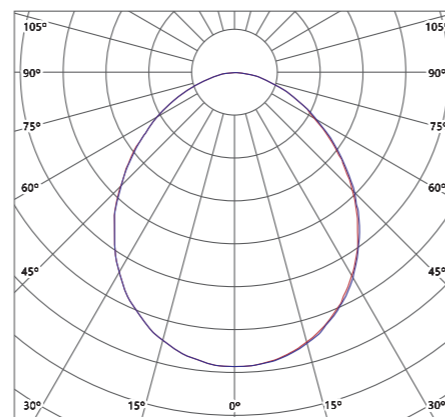

Front View

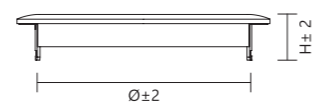
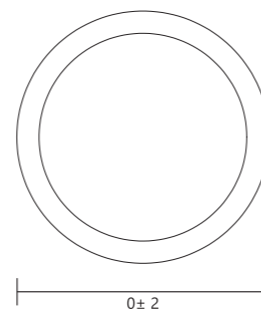

RECOMMENDED USAGE

• Retail Stores • Restaurants • Hotel Lobbies • Waiting Areas • Corporate Offices

TECHNICAL DETAILS

Model No.	System Wattage	Rated CCT	CRI	Rated Voltage	Power Factor	Dimensions (in mm)		
						Ø	Ø	H
LDRVP-012-C-FC	12W	6500K	≥80	240V AC	≥0.9	170	155	30
LDRVP-015-C-FC	15W	6500K	≥80	240V AC	≥0.9	170	155	30
LDRVP-018-C-FC	18W	6500K	≥80	240V AC	≥0.9	225	215	30

CCT's are available in Cool white, Neutral white & Warm white.

MERCURY PLUS FC

Recess backlit downlighter square with heat dissipating fins for larger surface area finished in epoxy powder coated white to deliver high efficacy light output and uniformity utilising back lit technology and revolutionary flicker- control technology that reduce harmful invisible flicker present in LED lighting sources.

PRODUCT SPECIFICATIONS

Housing

Designed in square shape with excellent thermally managed aluminium pressure die cast housing.

Optics

High transmittance opal diffuser for glare free symmetric light distribution.

Mounting

Fix into false ceiling by means of spring & clips provided.

Control Gear

Powered by an independent electronic LED driver with Output Short-circuit protection, Surge protection & other reliability tests.

Surge Protection

Up to 2.5 KV

IP

20

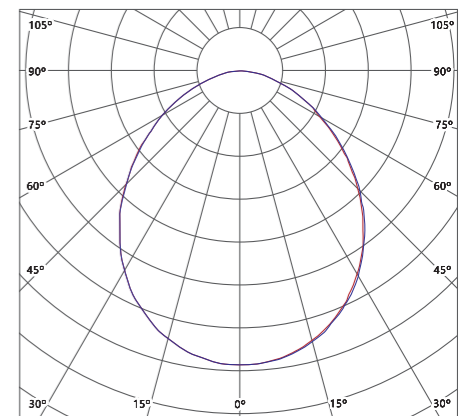

Front View

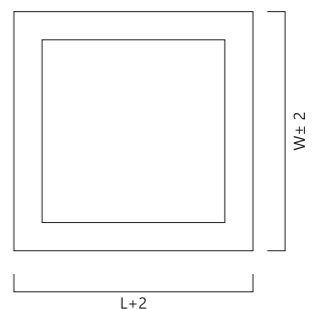

Side View

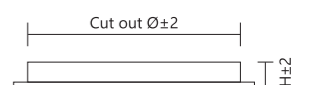

RECOMMENDED USAGE

• Retail Stores • Restaurants • Hotel Lobbies • Waiting Areas • Corporate Offices

TECHNICAL DETAILS

Model No.	System Wattage	Rated CCT	CRI	Rated Voltage	Power Factor	Dimensions (in mm)		
						LxW	Ø	H
LDRMP-012-C-FC	12W	6500K	≥80	240V AC	≥0.9	160 x 160	145 x 145	30
LDRMP-015-C-FC	15W	6500K	≥80	240V AC	≥0.9	160 x 160	145 x 145	30
LDRMP-018-C-FC	18W	6500K	≥80	240V AC	≥0.9	210 x 210	195 x 195	30

CCT's are available in Cool white, Neutral white & Warm white.

VENUS RECESS ECO FC

Recess-mounting low-height round LED downlighter housing and revolutionary Flicker-Control Technology that reduce harmful invisible flicker present in LED lighting sources.

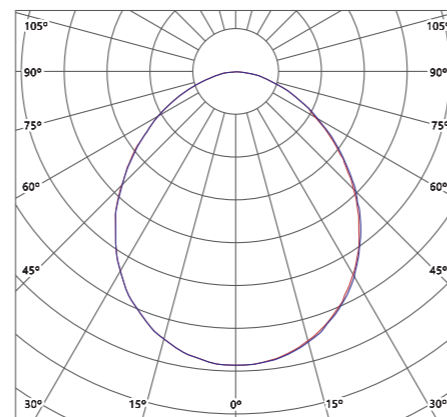

Front View

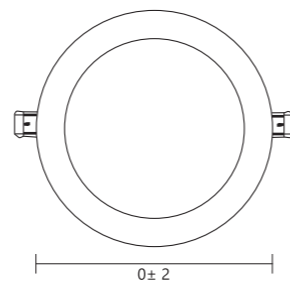

Side View

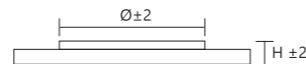

PRODUCT SPECIFICATIONS

Housing

Designed in polycarbonate housing for durability and aesthetics.

Optics

High transmittance opal diffuser for glare free uniform light distribution. High lumen efficacy LED with viewing angle of 120° used to enhance the lumen output.

Mounting

Fix into false ceiling by means of provided spring & clips.

Control Gear

Powered by an independent electronic LED driver with Output Short-Circuit Protection, Surge Protection & other reliability tests.

Surge Protection

Up to 2.5 KV

IP

20

RECOMMENDED USAGE

- Banks & Back Offices • Reception & Public Service Areas • Waiting Lounges
- Meeting Rooms • Corridors

TECHNICAL DETAILS

Model No.	System Wattage	CCT	CRI	Rated Voltage	Power Factor	Dimensions (in mm)		
						O	Ø	H
LDRVE-015-C-FC	15W	6500K	≥80	240V AC	≥0.9	170	150	20

CCT's are available in Cool white, Neutral white & Warm white.

VENUS SURFACE ECO FC

Surface-mounting low-height round LED downlighter housing and revolutionary Flicker-Control Technology to reduce harmful invisible flicker present in LED lighting sources.

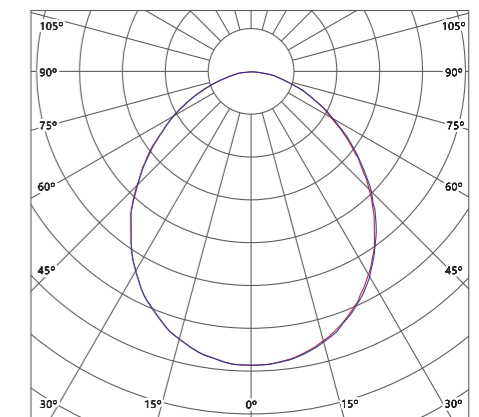

Front View

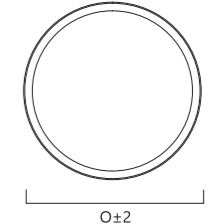

Side View



PRODUCT SPECIFICATIONS

Housing

Designed in polycarbonate housing for durability and aesthetics.

Optics

High transmittance opal diffuser for glare free uniform light distribution. High lumen efficacy LED with viewing angle of 120° used to enhance the lumen output.

Mounting

Surface mounting

Control Gear

Powered by an independent electronic LED driver with Output Short-Circuit Protection, Surge Protection & other reliability tests.

Surge Protection

Up to 2.5 KV

IP

20

RECOMMENDED USAGE

- Banks & Back Offices • Reception & Public Service Areas • Waiting Lounges
- Meeting Rooms • Corridors

TECHNICAL DETAILS

Model No.	System Wattage	CCT	CRI	Rated Voltage	Power Factor	Dimensions (in mm)	
						O	H
LDSVE-015-C-FC	15W	6500K	≥80	240V AC	≥0.9	170	30

CCT's are available in Cool white, Neutral white & Warm white.

MERCURY RECESS ECO FC

Recess-mounting low-height square LED downlighter housing and revolutionary Flicker-Control Technology to reduce harmful invisible flicker present in LED lighting sources.

PRODUCT SPECIFICATIONS

Housing

Designed in polycarbonate housing for durability and aesthetics.

Optics

High transmittance opal diffuser for glare free uniform light distribution. High lumen efficacy LED with viewing angle of 120° used to enhance the lumen output.

Mounting

Fix into false ceiling by means of provided spring & clips.

Control Gear

Powered by an independent electronic LED driver with Output Short-Circuit Protection, Surge Protection & other reliability tests.

Surge Protection

Up to 2.5 KV

IP

20

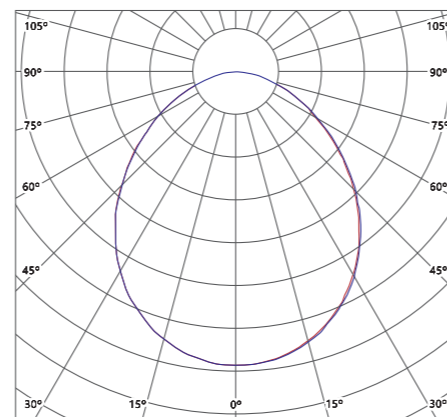
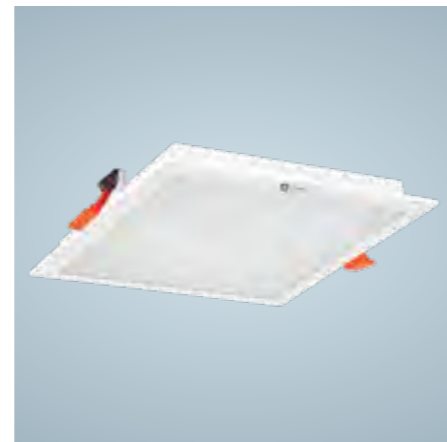

Front View

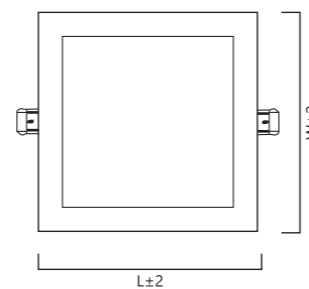

Side View

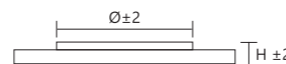

RECOMMENDED USAGE

- Banks & Back Offices • Reception & Public Service Areas • Waiting Lounges
- Meeting Rooms • Corridors

TECHNICAL DETAILS

Model No.	System Wattage	CCT	CRI	Rated Voltage	Power Factor	Dimensions (in mm)		
						LxW	Ø	H
LDRME-015-C-FC	15W	6500K	≥80	240V AC	≥0.9	170x170	150x150	20

CCT's are available in Cool white, Neutral white & Warm white.

MERCURY SURFACE ECO FC

Surface-mounting low-height square LED downlighter housing and revolutionary Flicker-Control Technology to reduce harmful invisible flicker present in LED lighting sources.

PRODUCT SPECIFICATIONS

Housing

Designed in polycarbonate housing for durability and aesthetics.

Optics

High transmittance opal diffuser for glare free uniform light distribution. High lumen efficacy LED with viewing angle of 120° used to enhance the lumen output.

Mounting

Surface mounting.

Control Gear

Powered by an independent electronic LED driver with Output Short-Circuit Protection, Surge Protection & other reliability tests.

Surge Protection

Up to 2.5 KV

IP

20

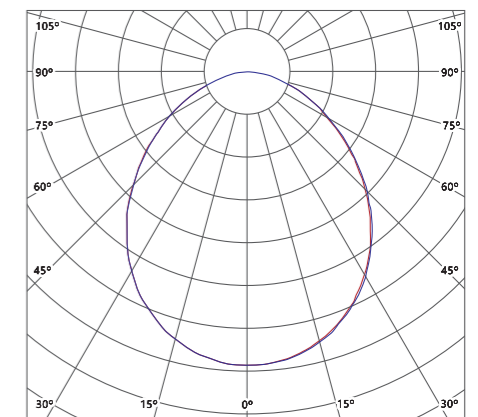

Front View

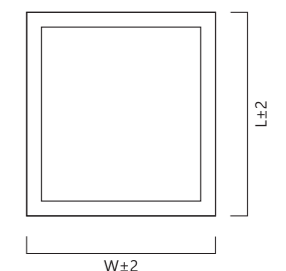

Side View



RECOMMENDED USAGE

- Banks & Back Offices • Reception & Public Service Areas • Waiting Lounges
- Meeting Rooms • Corridors

TECHNICAL DETAILS

Model No.	System Wattage	CCT	CRI	Rated Voltage	Power Factor	Dimensions (in mm)	
						LxW	H
LDSME-015-C-FC	15W	6500K	≥80	240V AC	≥0.9	170x170	30

CCT's are available in Cool white, Neutral white & Warm white.

AQUA RECESS 2X2 FC

Recess-mounting back-lit LED 2X2 tile in CRCA housing with full-opal diffuser suitable for Armstrong/Grid ceilings and revolutionary Flicker-Control Technology to reduce harmful invisible flicker present in LED lighting sources.

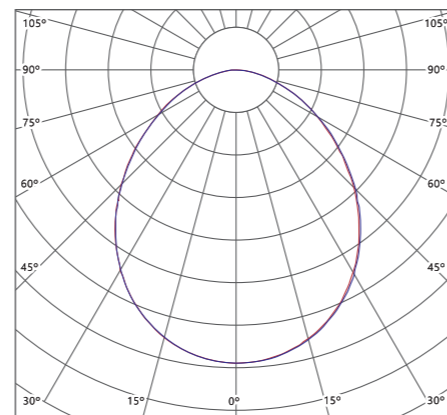

Front View

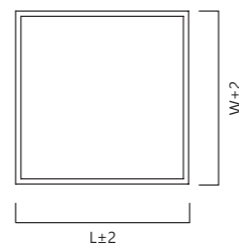

Side View

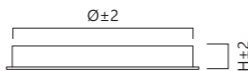

PRODUCT SPECIFICATIONS

Housing

CRCA powder-coated white after phosphochromate treatment.

Optics

High transmittance opal diffuser for glare free uniform light distribution. High lumen efficacy LED with viewing angle of 120° used to enhance the lumen output.

Mounting

Recessed mounting.

Control Gear

Powered by an independent electronic LED driver with Output Short-circuit protection, Surge protection & other reliability tests.

Surge Protection

Up to 2.5 KV

IP

20

RECOMMENDED USAGE

• Offices • BPOs • Hospitals • Banks • Meeting Rooms • Other Indoor Applications

TECHNICAL DETAILS

Model No.	System Wattage	CCT	CRI	Rated Voltage	Power Factor	Dimensions (in mm)		
						LxW	Ø	H
LTRAQ-36-C-FC	36W	6500K	≥80	240V AC	≥0.95	595x595	570x570	80

CCT's are available in Cool white, Neutral white & Warm white.

AQUA RECESS 1X4 FC

Recess-mounting back-lit LED 1X4 tile in CRCA housing with full-opal diffuser suitable for Armstrong/Grid ceilings and revolutionary Flicker-Control Technology to reduce harmful invisible flicker present in LED lighting sources.

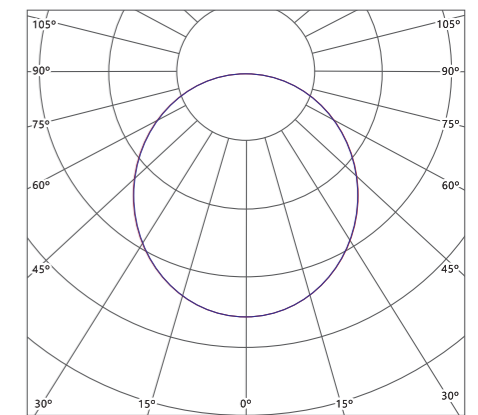

Front View



Side View

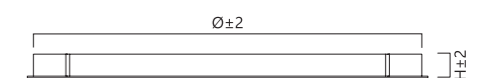

PRODUCT SPECIFICATIONS

Housing

CRCA white powder-coated after phosphochromate treatment.

Optics

High transmittance opal diffuser for glare free uniform light distribution. High lumen efficacy LED with viewing angle of 120° used to enhance the lumen output.

Mounting

Recessed mounting.

Control Gear

Powered by an independent electronic LED driver with Output Short-circuit protection, Surge protection & other reliability tests.

Surge Protection

Up to 2.5 KV

IP

20

RECOMMENDED USAGE

• Offices • BPOs • Hospitals • Banks • Meeting Rooms • Other Indoor Applications

TECHNICAL DETAILS

Model No.	System Wattage	CCT	CRI	Rated Voltage	Power Factor	Dimensions (in mm)		
						LxW	Ø	H
LTRAQ-36-C-1X4-FC	36W	6500K	≥80	240V AC	≥0.95	1195x295	1170x270	80

CCT's are available in Cool white, Neutral white & Warm white.

AQUA SURFACE 2X2 FC

Surface-mounting back-lit LED 2x2 tile in CRCA housing with full-opal diffuser for soft & glare-free light distribution and revolutionary Flicker-Control Technology to reduce harmful invisible flicker present in LED lighting sources.

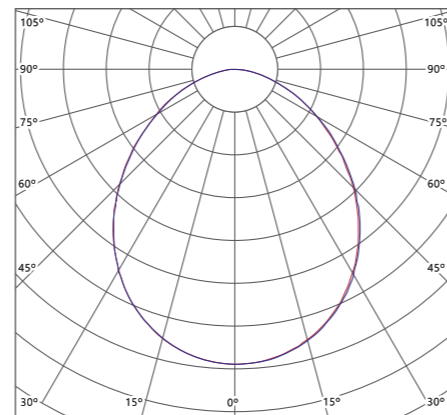
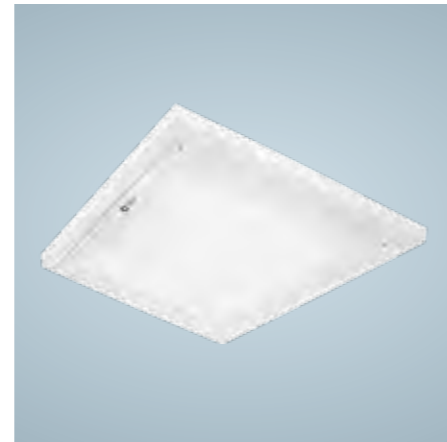

Front View

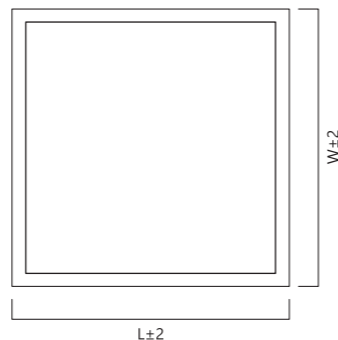

Side View

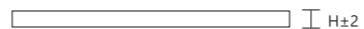

PRODUCT SPECIFICATIONS

Housing

CRCA powder-coated white after phosphochromate treatment.

Optics

High transmittance opal diffuser for glare free uniform light distribution. High lumen efficacy LED with viewing angle of 120° used to enhance the lumen output.

Mounting

Provision for surface mounting.

Control Gear

Powered by an independent electronic LED driver with Output Short-circuit protection, Surge protection & other reliability tests.

Surge Protection

Up to 2.5 KV

IP

20

RECOMMENDED USAGE

• Offices • BPOs • Hospitals • Banks • Meeting Rooms • Other Indoor Applications

TECHNICAL DETAILS

Model No.	System Wattage	CCT	CRI	Rated Voltage	Power Factor	Dimensions (in mm)		
						L	W	H
LTSAQ-36-C-FC	36W	6500K	≥80	240V AC	≥0.95	595	595	80

CCT's are available in Cool white, Neutral white & Warm white.

AQUA SURFACE 1X4 FC

Surface-mounting back-lit LED 1x4 tile in CRCA housing with full-opal diffuser for soft & glare-free light distribution and revolutionary Flicker-Control Technology to reduce harmful invisible flicker present in LED lighting sources.

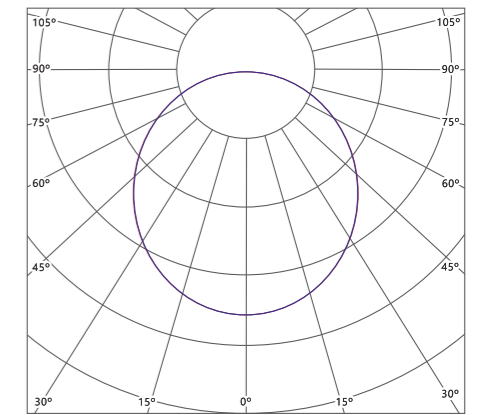
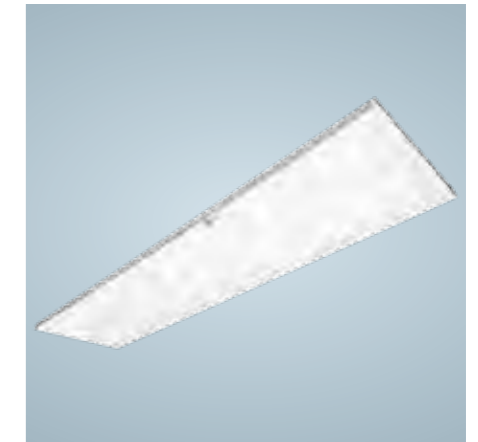

Front View

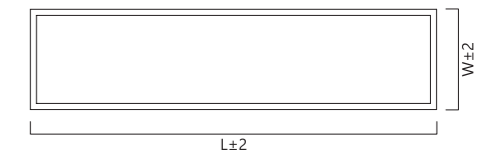

Side View



PRODUCT SPECIFICATIONS

Housing

CRCA powder-coated white after phosphochromate treatment.

Optics

High transmittance opal diffuser for glare free uniform light distribution. High lumen efficacy LED with viewing angle of 120° used to enhance the lumen output.

Mounting

Provision for surface mounting.

Control Gear

Powered by an independent electronic LED driver with Output Short-circuit protection, Surge protection & other reliability tests.

Surge Protection

Up to 2.5 KV

IP

20

RECOMMENDED USAGE

• Offices • BPOs • Hospitals • Banks • Meeting Rooms • Other Indoor Applications

TECHNICAL DETAILS

Model No.	System Wattage	CCT	CRI	Rated Voltage	Power Factor	Dimensions (in mm)		
						L	W	H
LTSAQ-36-C-1X4-FC	36W	6500K	≥80	240V AC	≥0.95	1195	295	80

CCT's are available in Cool white, Neutral white & Warm white.

DLINE RECESS FC

Seamless LED aluminium extruded recess-mounting luminaire for indoor architectural lighting solution and continuous mounting. It offers excellent energy saving and maintenance-free operation featured with best-in-class LED light sources with high luminous efficacy and highly translucent optical system to ensure maximum light output with excellent glare control and uniformity along with revolutionary Flicker-Control Technology to reduce harmful invisible flicker present in LED lighting sources.

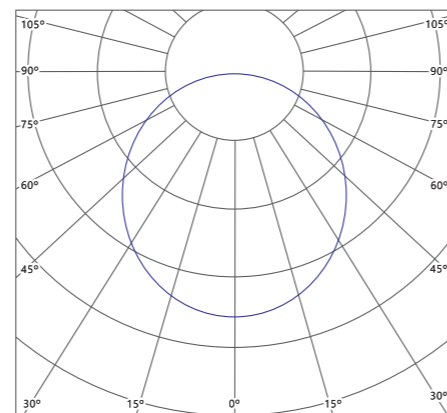

Side View

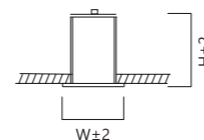
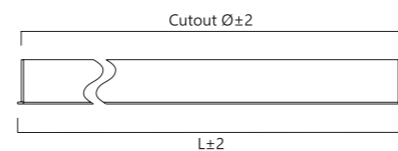

PRODUCT SPECIFICATIONS

Housing

Aluminum extruded housing in white powder-coated finish and plastic moulded end caps.

Optics

High transmittance opal diffuser for glare free uniform light distribution. High lumen efficacy LED with viewing angle of 120° used to enhance the lumen output.

Mounting

Suitable for Recess mounting through mounting clamps as per installation manual provided with the fixture. It can be installed in continuous mounting using joining kits.

Control Gear

Powered by an independent electronic LED driver with Output Short-circuit protection, Surge protection & other reliability tests.

Surge Protection

Up to 2.5 KV

IP

20

RECOMMENDED USAGE

• Offices • BPOs • Hospitals • Banks • Meeting Rooms • Other Indoor Applications

TECHNICAL DETAILS

Model No.	System Wattage	CCT	CRI	Rated Voltage	Power Factor	Dimensions (in mm)		
						LxW	Ø	H
LCRDL-28-C-66-FC	28W	6500K	≥80	240V AC	≥0.95	1211x66	120x54	38
LCRDL-36-C-90-FC	36W	6500K	≥80	240V AC	≥0.95	1212x90	1202x82	38

CCT's are available in Cool white, Neutral white & Warm white.

DLINE FC

Seamless LED aluminium extruded suspended luminaire for indoor architectural lighting solution. Offers excellent energy saving and maintenance-free operation. Suitable for continuous mounting linear lighting system. It enhances visual ambience with uniform illumination with its revolutionary Flicker-Control Technology reduces harmful invisible flicker present in LED lighting sources.

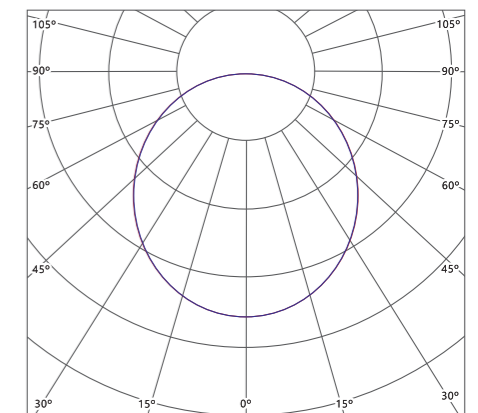

Side View

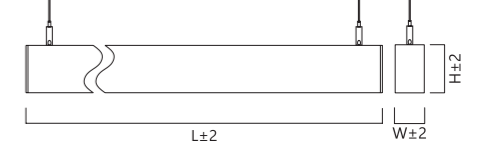

PRODUCT SPECIFICATIONS

Housing

Aluminum extruded housing in white powder-coated finish and plastic moulded end caps.

Optics

High transmittance opal diffuser for glare free uniform light distribution. High lumen efficacy LED with viewing angle of 120° used to enhance the lumen output.

Mounting

Suitable for suspended/surface mounting with height adjustable suspension kit. It can be installed in continuous mounting using joining kits.

Control Gear

Powered by an independent electronic LED with Output Short-circuit protection, Surge protection & other reliability tests.

Surge Protection

Up to 2.5 KV

IP

20

RECOMMENDED USAGE

• Offices • BPOs • Hospitals • Banks • Meeting Rooms • Other Indoor Applications

TECHNICAL DETAILS

Model No.	System Wattage	CCT	CRI	Rated Voltage	Power Factor	Dimensions (in mm)		
						L	W	H
LCPDL-28-C-54-FC	28W	6500K	≥80	240V AC	≥0.95	1200	54	73
LCPDL-36-C-75-FC	36W	6500K	≥80	240V AC	≥0.95	1200	75	85

CCT's are available in Cool white, Neutral white & Warm white.



INDOOR LIGHTING

XLINE

(Single-Side Connection)

Ultra-bright polycarbonate LED retrofit tube light with high efficacy. Suitable for the replacement of existing T8 & T12 fluorescent tube light with G13 lamp holder.

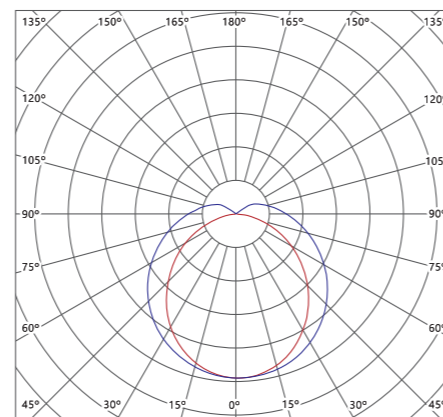

Front View

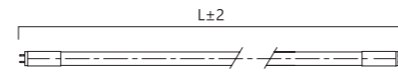

Side View

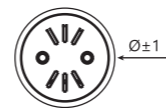

WIRING DIAGRAM

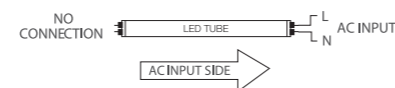

PRODUCT SPECIFICATIONS

Housing

Elegantly designed polycarbonate housing with opal finish to provide glare-free uniform light distribution. High-quality polycarbonate end caps are snap-fitted to the housing.

Optics

Polycarbonate diffuser to provide glare-free uniform light distribution. High lumen efficacy LED with viewing angle of 120° used to enhance the lumen output.

Mounting

Directly installed in existing T8/T12 FTL conventional lighting fixtures; refer to the wiring diagram for proper installation.

Control Gear

Powered by an integral constant-current driver suitable for 120-280 V AC working range.

Surge Protection

Up to 2.5 KV

IP

20

RECOMMENDED USAGE

• Commercial Buildings • Residential Buildings • Other Indoor Applications

TECHNICAL DETAILS

Model No.	System Wattage	Rated CCT	CRI	Rated Voltage	Power Factor	Dimensions (in mm)	
						L	Ø
LTXL-09-C	9W	6500K	≥80	240V AC	≥0.9	602	28
LTXL-18-C	18W	6500K	≥80	240V AC	≥0.9	1212	28
LTXL-20-C	20W	6500K	≥80	240V AC	≥0.9	1212	28

CCT's are available in Cool white, Neutral white & Warm white.

XLINE XT

(Double-Side Connection)

Ultra-bright polycarbonate LED retrofit tube light with high efficacy of 120 lm/W. Suitable for the replacement of existing T8 & T12 fluorescent tube light with G13 lamp holder.

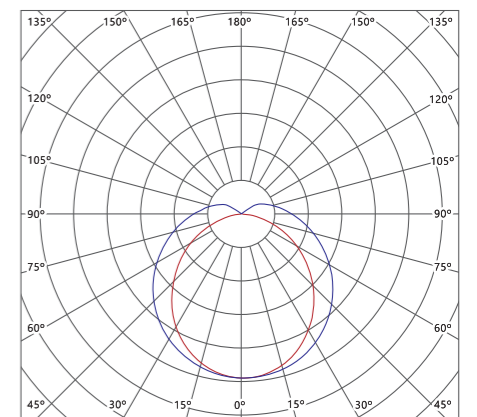

Front View

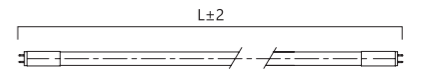

Side View

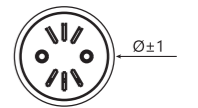

WIRING DIAGRAM

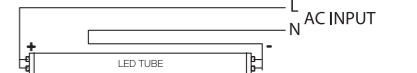

PRODUCT SPECIFICATIONS

Housing

Elegantly designed polycarbonate housing in opal finish to provide glare-free uniform light distribution. High-quality polycarbonate end caps are snap-fitted to the housing.

Optics

Polycarbonate diffuser to provide glare-free uniform light distribution. High lumen efficacy LED with viewing angle of 120° used to enhance the lumen output.

Mounting

Directly installed in existing T8/T12 FTL conventional lighting fixtures; refer to the wiring diagram for proper installation.

Control Gear

Powered by an integral constant-current driver suitable for 120-280 V AC working range.

Surge Protection

Up to 2.5 KV

IP

20

RECOMMENDED USAGE

• Commercial Buildings • Residential Buildings • Other Indoor Applications

TECHNICAL DETAILS

Model No.	System Wattage	Rated CCT	CRI	Rated Voltage	Power Factor	Dimensions (in mm)	
						L	Ø
LTXL-13-C-XT	13W	6500K	≥80	240V AC	≥0.9	1212	28
LTXL-18-C-XT-D	18W	6500K	≥80	240V AC	≥0.9	1212	28

CCT's are available in Cool white, Neutral white & Warm white.

POWERLINE SP

(Double-Side Connection)

Ultrabright LED retrofit tube light with aluminium housing and polycarbonate diffuser with high efficiency, suitable for replacement of existing T8 & T12 fluorescent tube light with G13 lamp holder.

PRODUCT SPECIFICATIONS

Housing

Elegantly designed aluminium heat sink for efficient heat dissipation.

Optics

Polycarbonate diffuser to provide glare-free uniform light distribution. High lumen efficacy LED with viewing angle of 120° used to enhance the lumen output.

Mounting

Directly installed in existing T8/T12 FTL conventional lighting fixtures; refer to the wiring diagram for proper installation.

Control Gear

Powered by an integral constant-current driver suitable for 120-280 V AC working range.

Surge Protection

Up to 2.5 KV

IP

20

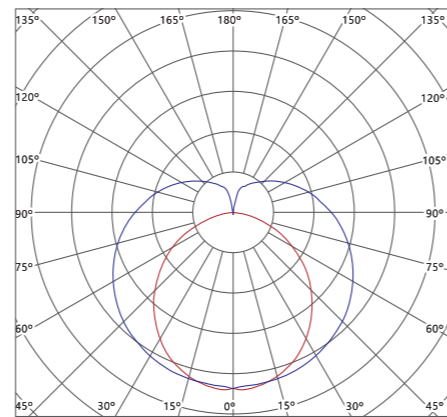

Front View

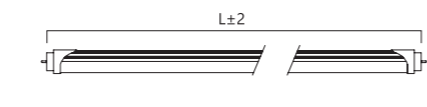

Side View

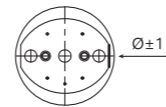

WIRING DIAGRAM

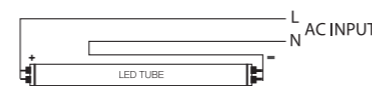

RECOMMENDED USAGE

• Commercial Buildings • Residential Buildings • Other Indoor Applications

TECHNICAL DETAILS

Model No.	System Wattage	Rated CCT	CRI	Rated Voltage	Power Factor	Dimensions (in mm)	
						L	Ø
LTPS-18-C	18W	6500K	≥80	240V AC	≥0.9	1212	32.5
LTPS-20-C	20W	6500K	≥80	240V AC	≥0.9	1212	32.5

CCT's are available in Cool white, Neutral white & Warm white.

POWERLINE SPXT

(Double-Side Connection)

Ultra-bright LED retrofit tube light with aluminium housing and polycarbonate diffuser with very high efficacy of 120lm/W; suitable for replacement of existing T8 & T12 fluorescent tube light with G13 lamp holder.

PRODUCT SPECIFICATIONS

Housing

Elegantly designed aluminium heat sink for efficient heat dissipation.

Optics

Polycarbonate diffuser to provide glare-free uniform light distribution. High lumen efficacy LED with viewing angle of 120° used to enhance the lumen output.

Mounting

Directly installed in existing T8/T12 FTL conventional lighting fixtures; refer to the wiring diagram for proper installation.

Control Gear

Powered by an integral constant current driver suitable for 120-280 V AC working range.

Surge Protection

Up to 2.5 KV

IP

20

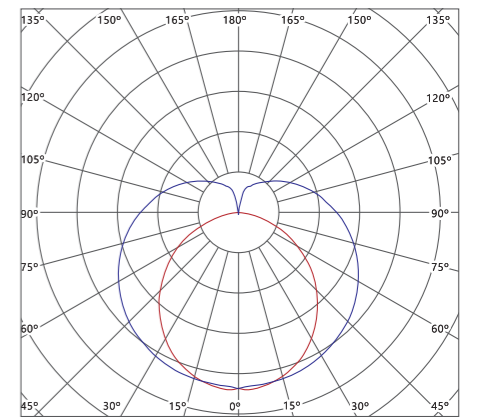

Front View

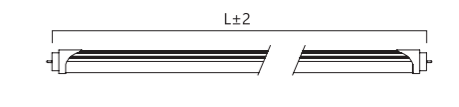

Side View

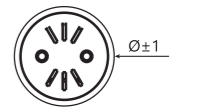

WIRING DIAGRAM

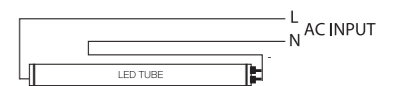

RECOMMENDED USAGE

• Commercial Buildings • Residential Buildings • Other Indoor Applications

TECHNICAL DETAILS

Model No.	System Wattage	Rated CCT	CRI	Rated Voltage	Power Factor	Dimensions (in mm)	
						L	Ø
LTPS-18-C-XT	18W	6500K	≥80	240V AC	≥0.9	1212	32.5

CCT's are available in Cool white, Neutral white & Warm white.

SLEEKLINE

(Double-Side Connection)

Ultra-bright LED retrofit tube light with aluminium housing and polycarbonate diffuser; suitable for replacement of existing T5 fluorescent tube light with G5 lamp holder.

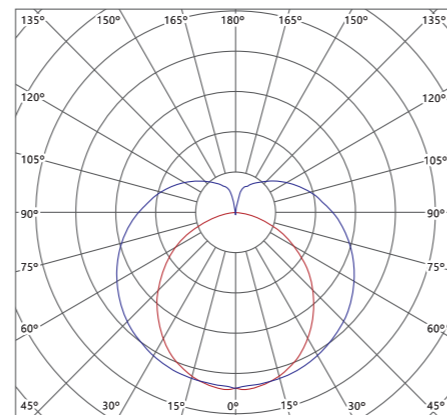

Front View

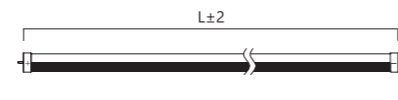

Side View

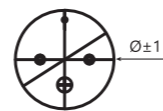

WIRING DIAGRAM

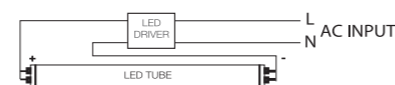

PRODUCT SPECIFICATIONS

Housing

Elegantly designed aluminium heat sink for efficient heat dissipation. High quality polycarbonate end caps are snap-fitted to the housing.

Optics

Polycarbonate diffuser to provide glare-free uniform light distribution. High lumen efficacy LED with viewing angle of 120° used to enhance the lumen output.

Mounting

Directly installed in existing T5 FTL conventional lighting fixtures; refer to the wiring diagram for proper installation.

Control Gear

Powered by constant-current driver suitable for 120-280 V AC working range.

Surge Protection

Up to 2.5 KV

IP

20

RECOMMENDED USAGE

• Commercial Buildings • Residential Buildings • Other Indoor Applications

TECHNICAL DETAILS

Model No.	System Wattage	Rated CCT	CRI	Rated Voltage	Power Factor	Dimensions (in mm)	
						L	Ø
LTSL-018-C	18W	6500K	≥80	240V AC	≥0.9	1164	16.5

CCT's are available in Cool white, Neutral white & Warm white.



TASKLINE

Slim LED batten with polycarbonate housing and diffuser is an ideal replacement solution for existing battens/fluorescent lamps with elegantly designed end caps.

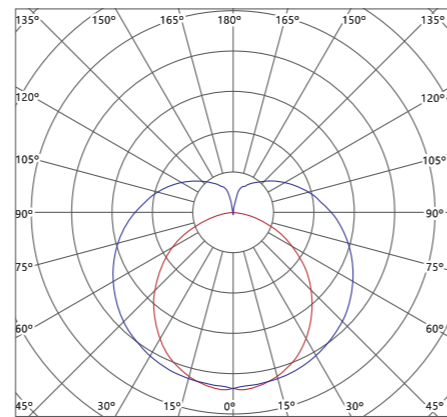

Front View

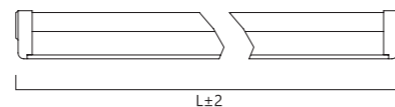

Side View

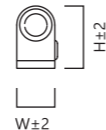

PRODUCT SPECIFICATIONS

Housing

Made of ultra-slim co-extruded polycarbonate channel with the housing part in white finish & diffuser part in opal finish. White-finish ABS end caps with decorative circular polycarbonate cap snap-fitted on the end cap to enhance the aesthetic of the fixture. These end caps are snapfitted to the fixture.

Optics

Polycarbonate diffuser to provide glare-free uniform light distribution. High lumen efficacy LED with viewing angle of 120° used to enhance the lumen output.

Mounting

Fix directly into the wall/ceiling by means of mounting SS clips provided with the fixture.

Control Gear

Integral electronic driver with Output Short-Circuit Protection/Open Circuit Protection, Surge Voltage Protection and other safety tests.

Surge Protection

Up to 2.5 KV

IP

20

RECOMMENDED USAGE

• Commercial Buildings • Residential Buildings • Other Indoor Applications

TECHNICAL DETAILS

Model No.	System Wattage	Rated CCT	CRI	Rated Voltage	Power Factor	Dimensions (in mm)		
						L	W	H
LBLN-18-C	18W	6500K	≥80	240V AC	≥0.9	1135	21.5	36.5
LBLN-20-C	20W	6500K	≥80	240V AC	≥0.9	1135	21.5	36.5

CCT's are available in Cool white, Neutral white & Warm white.

TASKLINE SQUARE

Slim LED batten with polycarbonate housing and diffuser is an ideal replacement solution for existing battens/fluorescent lamps with elegantly designed end caps.

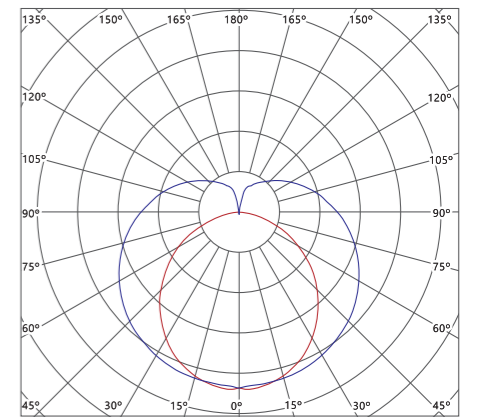

Front View

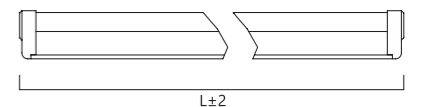

Side View

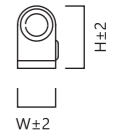

PRODUCT SPECIFICATIONS

Housing

Made of ultra-slim co-extruded polycarbonate channel with housing part in white finish & diffuser part in opal finish. White-finish ABS end caps with decorative square polycarbonate cap are snap-fitted on the end cap to enhance the aesthetic of the fixture. These end caps are snapfitted to the fixture.

Optics

Polycarbonate diffuser to provide glare-free uniform light distribution. High lumen efficacy LED with viewing angle of 120° used to enhance the lumen output.

Mounting

Fix directly into the wall/ceiling by means of mounting SS clips provided with the fixture.

Control Gear

Integral electronic driver with Output Short Circuit Protection/Open Circuit Protection, Surge Voltage Protection and other safety tests.

Surge Protection

Up to 2.5 KV

IP

20

RECOMMENDED USAGE

• Commercial Buildings • Residential Buildings • Other Indoor Applications

TECHNICAL DETAILS

Model No.	System Wattage	Rated CCT	CRI	Rated Voltage	Power Factor	Dimensions (in mm)		
						L	W	H
LBLN-10-C-SQ	10W	6500K	≥80	240V AC	≥0.9	591	21.5	37
LBLN-18-C-SQ	18W	6500K	≥80	240V AC	≥0.9	1184	21.5	37
LBLN-20-C-SQ	20W	6500K	≥80	240V AC	≥0.9	1184	21.5	37
LBLN-22-C-SQ	22W	6500K	≥80	240V AC	≥0.9	1184	21.5	37

CCT's are available in Cool white, Neutral white & Warm white.

TASKLINE AL

Slim LED batten with aluminium housing and polycarbonate diffuser with elegantly designed End caps. It is an ideal replacement solution for existing battens fluorescent lamps.

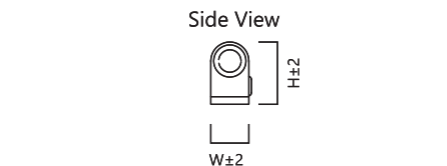
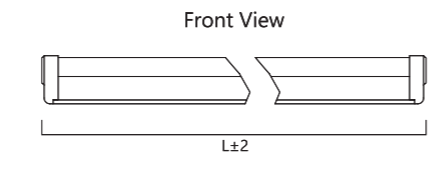
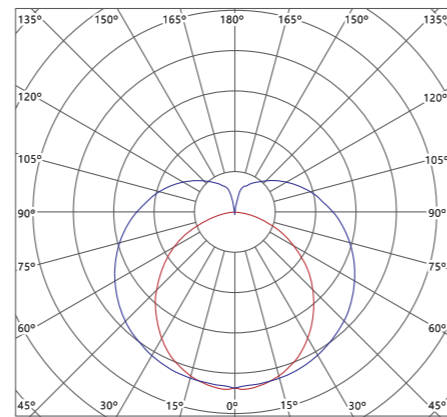

PRODUCT SPECIFICATIONS

Housing

Epoxy powder-coated white extruded aluminium channel housing for efficient heat dissipation. Elegantly designed white-coloured ABS end caps enhance the aesthetics of the fixture.

Optics

Polycarbonate diffuser to provide glare-free uniform light distribution. High lumen efficacy LED with viewing angle of 120° used to enhance the lumen output.

Mounting

Fix directly into the wall/ceiling by means of mounting SS clips provided with the fixture.

Control Gear

Powered by an integral electronic driver with Output Short-Circuit Protection, Surge Protection & other safety tests.

Surge Protection

Up to 2.5 KV

IP

20

RECOMMENDED USAGE

• Commercial Buildings • Residential Buildings • Other Indoor Applications • Industrial Buildings

TECHNICAL DETAILS

Model No.	System Wattage	Rated CCT	CRI	Rated Voltage	Power Factor	Dimensions (in mm)		
						L	W	H
LBLN-18-C-AL	18W	6500K	≥80	240V AC	≥0.9	1183	21.5	36.5
LBLN-20-C-AL	20W	6500K	≥80	240V AC	≥0.9	1183	21.5	36.5
LBLN-22-C-AL	22W	6500K	≥80	240V AC	≥0.9	1183	21.5	36.5
LBLN-36-C-AL	36W	6500K	≥80	240V AC	≥0.9	1188	27.0	35.0

CCT's are available in Cool white, Neutral white & Warm white.

LED BATTEN-1/2X18 LED

Universal battens with powder-coated CRCA housing complete with prewired Control Gear. Suitable for T5 and T8/T12 LED tubes.

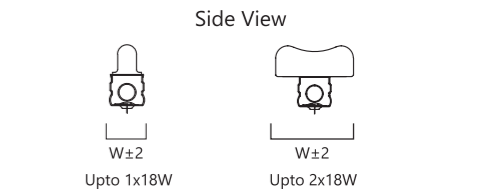
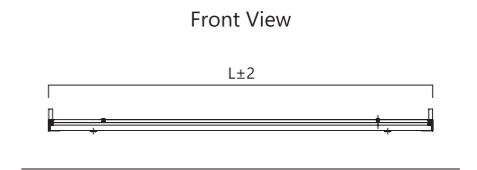

PRODUCT SPECIFICATIONS

Housing

Housing & cover made up of CRCA sheet steel. Cover is fixed to the housing by means of bolts with engineering plastic head. Epoxy powder-coated white after phosphochromate treatment. Push-fit type white polycarbonate housing and ABS rotor with corrosion-resistant brass contacts.

Optics

White powder-coated CRCA sheet.

Mounting

On ceiling/wall with screws.

Control Gear

Complete internal wiring suitable for retrofit LED tubelight with single/double side connections.

Surge Protection

Up to 2.5 KV

IP

20

RECOMMENDED USAGE

• Commercial Buildings • Residential Buildings • Other Indoor Applications • Industrial Buildings

TECHNICAL DETAILS

Model No.	Suitable For*	Dimensions (in mm)	
		L	W
LIBT-118-SS	1X18/20 W T8 LED TUBE	1230	45
LIBT-218-SS	2X18/20 W T8 LED TUBE	1230	100
LIBT-118-DS	1X18/20 W T8 LED TUBE	1230	45
LIBT-218-DS	2X18/20 W T8 LED TUBE	1230	100
LIBT-118-T5	1X18 W T5 LED TUBE	1230	45
LIBT-218-T5	2X18 W T5 LED TUBE	1230	100

*Tubes to be ordered separately.



VENUS

Recess-mounting round LED downlighter designed with back-lit technology.

PRODUCT SPECIFICATIONS

Housing

Designed with excellent thermally managed aluminium pressure die-cast housing with heat-dissipating fins for larger surface area, finished in epoxy powder-coated white.

Optics

High transmittance opal diffuser for glare free uniform light distribution. High lumen efficacy LED with viewing angle of 120° used to enhance the lumen output.

Mounting

Fix into false ceiling by means of provided spring & clips.

Control Gear

Powered by an independent electronic LED driver with Output Short-Circuit Protection, Surge Protection & other reliability tests.

Surge Protection

Up to 2.5 KV

IP

20

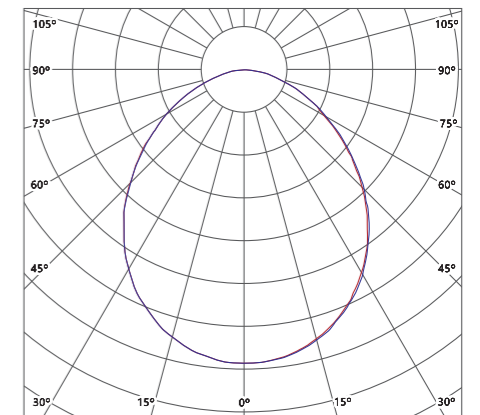

Front View

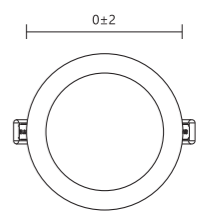

Side View

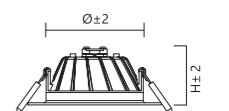

RECOMMENDED USAGE

- Banks & Back Offices • Reception & Public Service Areas • Waiting Lounges
- Meeting Rooms • Corridors

TECHNICAL DETAILS

Model No.	System Wattage	Rated CCT	CRI	Rated Voltage	Power Factor	Dimensions (in mm)		
						Ø	Ø	H
LDRVS-010-C	10W	6500K	≥80	240V AC	≥0.9	170	145	50
LDRVS-015-C	15W	6500K	≥80	240V AC	≥0.9	170	145	50
LDRVS-020-C	20W	6500K	≥80	240V AC	≥0.9	170	145	50
LDRVS-022-C	22W	6500K	≥80	240V AC	≥0.9	170	145	50
LDRVS-024-C	24W	6500K	≥80	240V AC	≥0.9	170	145	50

CCT's are available in Cool white, Neutral white & Warm white.

VENUS PLUS

Recess backlit downlighter round with heat dissipating fins for larger surface area finished in epoxy powder coated white to deliver high efficacy light output and uniformity utilising back lit technology.

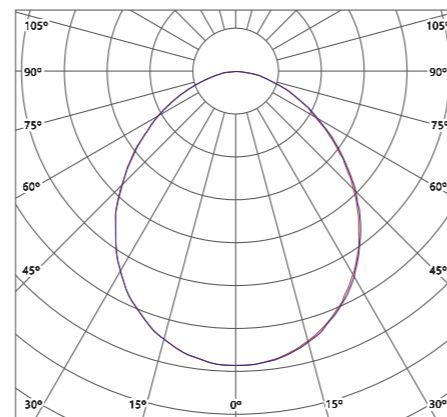

Front View

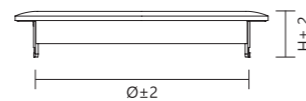
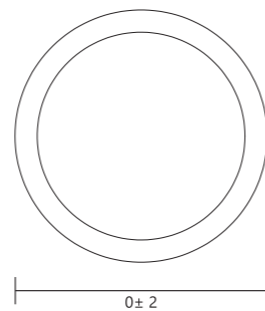

PRODUCT SPECIFICATIONS

Housing

Designed in round shape with excellent thermally managed aluminium pressure die cast housing.

Optics

High transmittance opal diffuser for glare free symmetric light distribution.

Mounting

Fix into false ceiling by means of spring & clips provided.

Control Gear

Powered by an independent electronic LED driver with Output Short-circuit protection, Surge protection & other reliability tests.

Surge Protection

Up to 2.5 KV

IP

20

RECOMMENDED USAGE

• Retail Stores • Restaurants • Hotel Lobbies • Waiting Areas • Corporate Offices

TECHNICAL DETAILS

Model No.	System Wattage	Rated CCT	CRI	Rated Voltage	Power Factor	Dimensions (in mm)		
						Ø	Ø	H
LDRVP-06-C	6W	6500K	≥80	240V AC	≥0.9	110	85	30
LDRVP-012-C	12W	6500K	≥80	240V AC	≥0.9	170	155	30
LDRVP-015-C	15W	6500K	≥80	240V AC	≥0.9	170	155	30
LDRVP-018-C	18W	6500K	≥80	240V AC	≥0.9	225	215	30

CCT's are available in Cool white, Neutral white & Warm white.

MERCURY PLUS

Recess backlit downlighter square with heat dissipating fins for larger surface area finished in epoxy powder coated white to deliver high efficacy light output and uniformity utilising back lit technology.

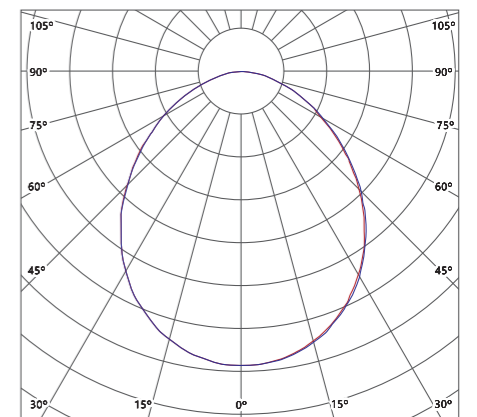

Front View

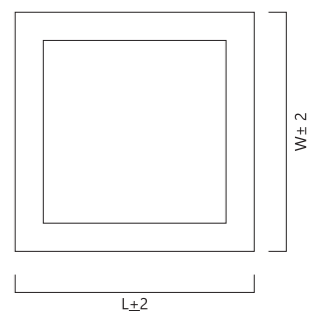

Side View

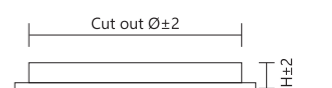

PRODUCT SPECIFICATIONS

Housing

Designed in square shape with excellent thermally managed aluminium pressure die cast housing.

Optics

High transmittance opal diffuser for glare free symmetric light distribution.

Mounting

Fix into false ceiling by means of spring & clips provided.

Control Gear

Powered by an independent electronic LED driver with Output Short-circuit protection, Surge protection & other reliability tests.

Surge Protection

Up to 2.5 KV

IP

20

RECOMMENDED USAGE

• Retail Stores • Restaurants • Hotel Lobbies • Waiting Areas • Corporate Offices

TECHNICAL DETAILS

Model No.	System Wattage	Rated CCT	CRI	Rated Voltage	Power Factor	Dimensions (in mm)		
						LxW	Ø	H
LDRMP-06-C	6W	6500K	≥80	240V AC	≥0.9	95 x 95	85 x 85	30
LDRMP-012-C	12W	6500K	≥80	240V AC	≥0.9	160 x 160	145 x 145	30
LDRMP-015-C	15W	6500K	≥80	240V AC	≥0.9	160 x 160	145 x 145	30
LDRMP-018-C	18W	6500K	≥80	240V AC	≥0.9	210 x 210	195 x 195	30

CCT's are available in Cool white, Neutral white & Warm white.



EDGE RECESS ROUND PANEL

Ultrathin recess-mounting round LED downlighter designed with edge-lit technology with heat-dissipating fins for larger surface area. finished in epoxy powder-coated white to deliver high efficacy light output and uniformity, utilising edge-lit technology.

PRODUCT SPECIFICATIONS

Housing

Designed with excellent thermally managed aluminium pressure die-cast housing.

Optics

High transmittance opal diffuser for glare free uniform light distribution. High lumen efficacy LED with viewing angle of 120° used to enhance the lumen output.

Mounting

Fix into false ceiling by means of provided spring & clips.

Control Gear

Powered by an independent electronic LED driver with Output Short-Circuit Protection, Surge Protection & other reliability tests

Surge Protection

Up to 2.5 KV

IP

20

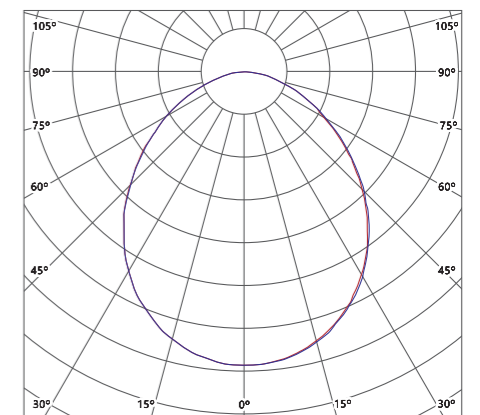

Front View

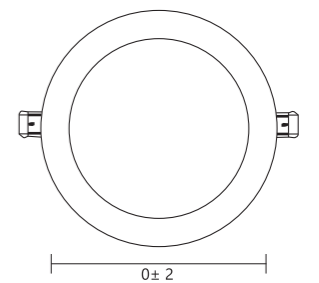

Side View

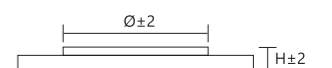

RECOMMENDED USAGE

• Retail Stores • Restaurants • Hotel Lobbies • Waiting Areas • Corporate Offices

TECHNICAL DETAILS

Model No.	System Wattage	Rated CCT	CRI	Rated Voltage	Power Factor	Dimensions (in mm)		
						Ø	H	
LDRER-06-C	6W	6500K	≥80	240V AC	≥0.9	120	105	22
LDRER-12-C	12W	6500K	≥80	240V AC	≥0.9	170	160	22
LDRER-15-C	15W	6500K	≥80	240V AC	≥0.9	200	180	22
LDRER-18-C	18W	6500K	≥80	240V AC	≥0.9	225	205	22

CCT's are available in Cool white, Neutral white & Warm white.

EDGE RECESS SQUARE PANEL

Ultraslim recess-mounting square LED downlighter designed with edge-lit technology.

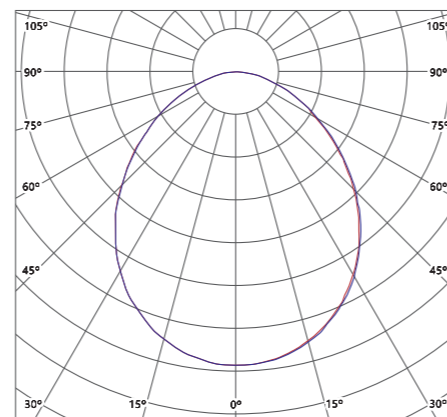

Front View

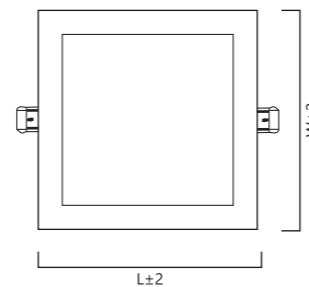

Side View

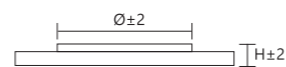

PRODUCT SPECIFICATIONS

Housing

Designed with excellent thermally managed aluminium pressure die-cast housing with heat-dissipating fins for larger surface area, finished in epoxy powder-coated white to deliver high efficacy light output and uniformity, utilising edge-lit technology.

Optics

High transmittance opal diffuser for glare free uniform light distribution. High lumen efficacy LED with viewing angle of 120° used to enhance the lumen output.

Mounting

Fix into false ceiling by means of provided spring and clips.

Control Gear

Powered by an independent electronic LED driver with Output Short-Circuit Protection, Surge Protection & other reliability tests

Surge Protection

Up to 2.5 KV

IP

20

RECOMMENDED USAGE

• Retail Stores • Restaurants • Hotel Lobbies • Waiting Areas • Corporate Offices

TECHNICAL DETAILS

Model No.	System Wattage	Rated CCT	CRI	Rated Voltage	Power Factor	Dimensions (in mm)		
						LxW	Ø	H
LDRES-06-C	6W	6500K	≥80	240V AC	≥0.9	120 x 120	105 x 105	13
LDRES-12-C	12W	6500K	≥80	240V AC	≥0.9	170 x 170	160 x 160	13
LDRES-18-C	18W	6500K	≥80	240V AC	≥0.9	225 x 225	205 x 205	22
LDRES-24-C	24W	6500K	≥80	240V AC	≥0.9	300 x 300	280 x 280	22

CCT's are available in Cool white, Neutral white & Warm white.

EDGE SURFACE ROUND PANEL

Ultraslim surface-mounting round LED downlighter designed with edge-lit technology.

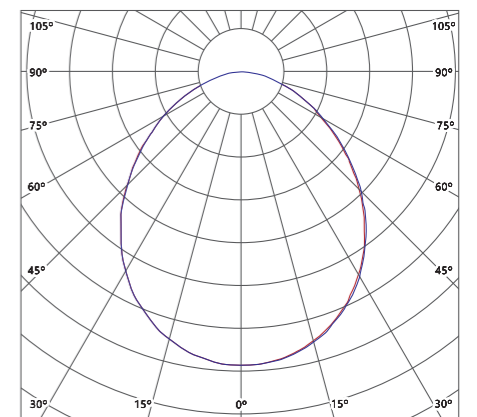

Front View

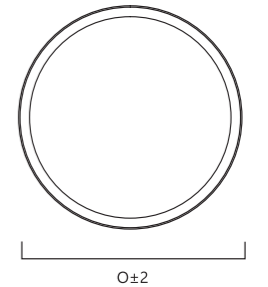

Side View

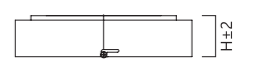

PRODUCT SPECIFICATIONS

Housing

Designed with excellent thermally managed aluminium pressure die-cast housing with heat-dissipating fins for larger surface area, finished in epoxy powder-coated white to deliver high efficacy light output and uniformity, utilising edge-lit technology.

Optics

High transmittance opal diffuser for glare free uniform light distribution. High lumen efficacy LED with viewing angle of 120° used to enhance the lumen output.

Mounting

Surface mounting

Control Gear

Powered by an independent electronic LED driver with Output Short-Circuit Protection, Surge Protection & other reliability tests.

Surge Protection

Up to 2.5 KV

IP

20

RECOMMENDED USAGE

• Retail Stores • Restaurants • Hotel Lobbies • Waiting Areas • Corporate Offices

TECHNICAL DETAILS

Model No.	System Wattage	Rated CCT	CRI	Rated Voltage	Power Factor	Dimensions (in mm)	
						Ø	H
LDSE-06-C	6W	6500K	≥80	240V AC	≥0.9	120	35
LDSE-12-C	12W	6500K	≥80	240V AC	≥0.9	170	35
LDSE-18-C	18W	6500K	≥80	240V AC	≥0.9	225	35

CCT's are available in Cool white, Neutral white & Warm white.



EDGE SURFACE SQUARE PANEL

Ultraslim surface-mounting square LED downlighter designed with edge-lit technology.

PRODUCT SPECIFICATIONS

Housing

Designed with excellent thermally managed aluminium pressure die-cast housing with heat dissipating fins for larger surface area, finished in epoxy powder-coated white to deliver high efficacy light output and uniformity, utilising edge-lit technology.

Optics

High transmittance opal diffuser for glare free uniform light distribution. High lumen efficacy LED with viewing angle of 120° used to enhance the lumen output.

Mounting

Surface-mounting.

Control Gear

Powered by an independent electronic LED driver with Output Short-Circuit Protection, Surge Protection & other reliability tests.

Surge Protection

Up to 2.5 KV

IP

20

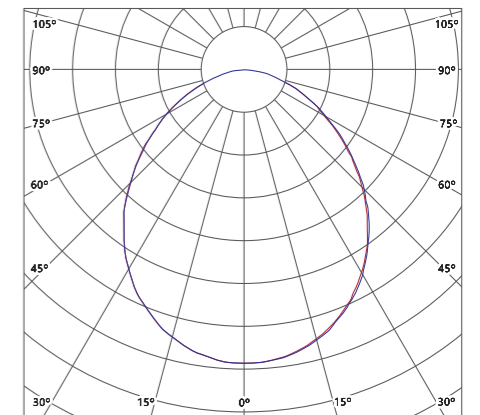

Front View

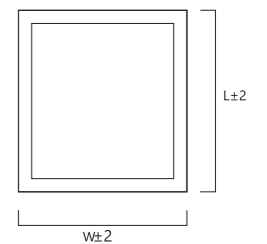

Side View



RECOMMENDED USAGE

• Retail Stores • Restaurants • Hotel Lobbies • Waiting Areas • Corporate Offices

TECHNICAL DETAILS

Model No.	System Wattage	Rated CCT	CRI	Rated Voltage	Power Factor	Dimensions (in mm)	
						LxW	H
LDSES-06-C	6W	6500K	≥80	240V AC	≥0.9	120 x 120	35
LDSES-12-C	12W	6500K	≥80	240V AC	≥0.9	170 x 170	35
LDSES-18-C	18W	6500K	≥80	240V AC	≥0.9	225 x 225	35

CCT's are available in Cool white, Neutral white & Warm white.

AQUA RECESS 2X2

Recess-mounting back-lit LED 2X2 tile in CRCA housing with full opal diffuser; suitable for Armstrong/Grid ceilings.

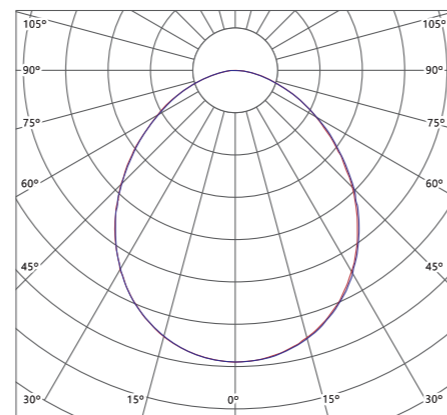

Front View

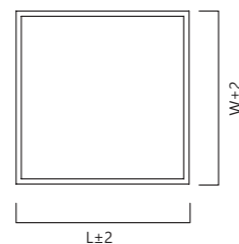

Side View

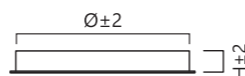

PRODUCT SPECIFICATIONS

Housing

CRCA powder-coated white after phosphochromate treatment.

Optics

High transmittance opal diffuser for glare free uniform light distribution. High lumen efficacy LED with viewing angle of 120° used to enhance the lumen output.

Mounting

Recess-mounting.

Control Gear

Powered by an independent electronic LED driver with Output Short-Circuit Protection, Surge Protection & other reliability tests.

Surge Protection

Up to 2.5 KV

IP

20

RECOMMENDED USAGE

• Offices • BPOs • Hospitals • Banks • Meeting Rooms • Other Indoor Applications

TECHNICAL DETAILS

Model No.	System Wattage	Rated CCT	CRI	Rated Voltage	Power Factor	Dimensions (in mm)		
						LxW	Ø	H
LTRAQ-24-C	24W	6500K	≥80	240V AC	≥0.95	595x595	570x570	80
LTRAQ-30-C	30W	6500K	≥80	240V AC	≥0.95	595x595	580x580	80
LTRAQ-36-C	36W	6500K	≥80	240V AC	≥0.95	595x595	580x580	80
LTRAQ-42-C	42W	6500K	≥80	240V AC	≥0.95	595x595	580x580	80

CCT's are available in Cool white, Neutral white & Warm white.

AQUA RECESS 1X4

Recess-mounting back-lit LED 1x4 tile in CRCA housing with full opal diffuser; suitable for Armstrong/Grid ceilings.

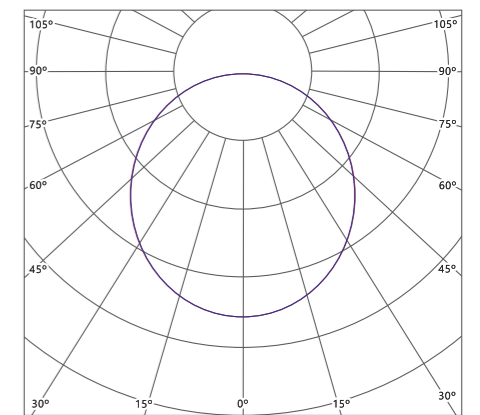

Front View

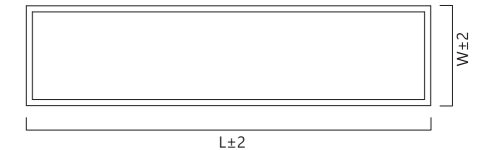

Side View

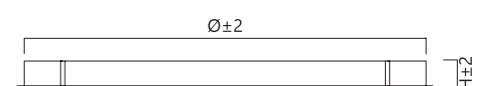

PRODUCT SPECIFICATIONS

Housing

CRCA powder-coated white after phosphochromate treatment.

Optics

High transmittance opal diffuser for glare free uniform light distribution. High lumen efficacy LED with viewing angle of 120° used to enhance the lumen output.

Mounting

Recess-mounting.

Control Gear

Powered by an independent electronic LED driver with Output Short-Circuit Protection, Surge Protection & other reliability tests.

Surge Protection

Up to 2.5 KV

IP

20

RECOMMENDED USAGE

• Offices • BPOs • Hospitals • Banks • Meeting Rooms • Other Indoor Applications

TECHNICAL DETAILS

Model No.	System Wattage	Rated CCT	CRI	Rated Voltage	Power Factor	Dimensions (in mm)		
						LxW	Ø	H
LTRAQ-36-C-1X4	36W	6500K	≥80	240V AC	≥0.95	1195x295	1170x270	80

CCT's are available in Cool white, Neutral white & Warm white.

HYDRA 2X2

Recess-mounting ultraslim LED 2x2 edge-lit tile in aluminium extruded housing with full opal diffuser; suitable for perfect lighting conditions for various visual tasks in offices and general areas.

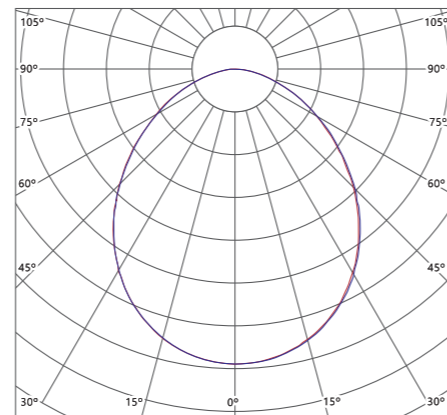

Front View

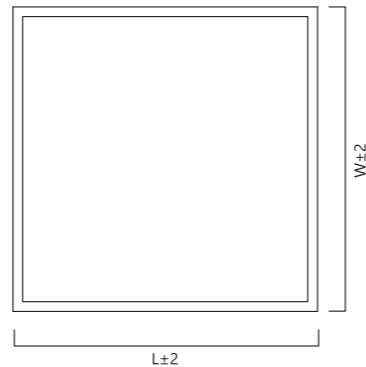

Side View



PRODUCT SPECIFICATIONS

Housing

White powder-coated aluminium extruded frame for better thermal management with a CRCA sheet used as a back cover and fixed with an aluminium extrusion through SS screws.

Optics

Micro-structured wave guide (LGP), opal diffuser for glare-free uniform light distribution. High lumen efficacy LED with viewing angle of 120° used to enhance the lumen output.

Mounting

Suitable for Armstrong/Grid ceiling.

Control Gear

Powered by an independent electronic LED driver with Output Short-Circuit Protection, Surge protection & other reliability tests.

Surge Protection

Up to 2.5 KV

IP

20

RECOMMENDED USAGE

• Offices • BPOs • Hospitals • Banks • Meeting Rooms • Other Indoor Applications

TECHNICAL DETAILS

Model No.	System Wattage	Rated CCT	CRI	Rated Voltage	Power Factor	Dimensions (in mm)		
						L	W	H
LTRHD-36-C	36W	6500K	≥80	240V AC	≥0.95	595	595	14

CCT's are available in Cool white, Neutral white & Warm white.

HYDRA 1X4

Recess-mounting ultraslim LED 1x4 edge-lit tile in aluminium extruded housing with full opal diffuser; suitable for perfect lighting conditions for various visual tasks in offices and general areas.

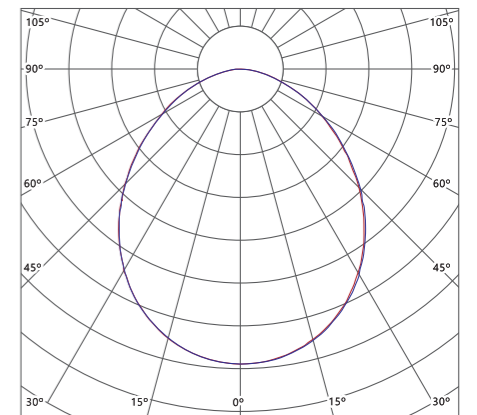

Front View

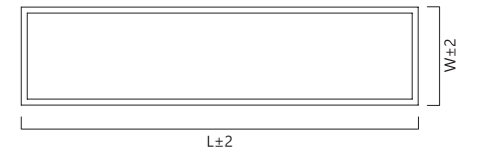

Side View



PRODUCT SPECIFICATIONS

Housing

White powder-coated aluminium extruded frame for better thermal management with a CRCA sheet used as a back cover and fixed with an aluminium extrusion through SS screws.

Optics

Micro-structured wave guide (LGP), opal diffuser for glare-free uniform light distribution. High lumen efficacy LED with viewing angle of 120° used to enhance the lumen output.

Mounting

Suitable for Armstrong/Grid ceiling.

Control Gear

Powered by an independent electronic LED driver with Output Short-Circuit Protection, Surge Protection & other reliability tests.

Surge Protection

Up to 2.5 KV

IP

20

RECOMMENDED USAGE

• Offices • BPOs • Hospitals • Banks • Meeting Rooms • Other Indoor Applications

TECHNICAL DETAILS

Model No.	System Wattage	Rated CCT	CRI	Rated Voltage	Power Factor	Dimensions (in mm)		
						L	W	H
LTRHD-36-C-1X4	36W	6500K	≥80	240V AC	≥0.95	1195	295	14

CCT's are available in Cool white, Neutral white & Warm white.



HYDRA 1X1

Recess-mounting ultraslim LED 1x1 edge-lit tile in aluminium extruded housing with full opal diffuser; suitable for perfect lighting conditions for various visual tasks in offices and general areas.

PRODUCT SPECIFICATIONS

Housing

White powder-coated aluminium extruded frame for better thermal management with a CRCA sheet used as a back cover and fixed with an aluminium extrusion through SS screws.

Optics

Micro-structured wave guide (LGP), opal diffuser for glare-free uniform light distribution. High lumen efficacy LED with viewing angle of 120° used to enhance the lumen output.

Mounting

Suitable for Armstrong ceiling.

Control Gear

Powered by an independent electronic LED driver with Output Short-Circuit Protection, Surge Protection & other reliability tests.

Surge Protection

Up to 2.5 KV

IP

20

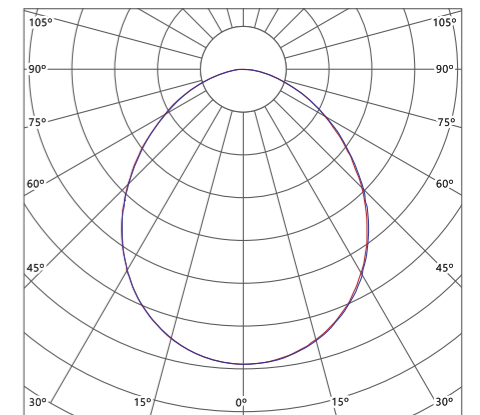
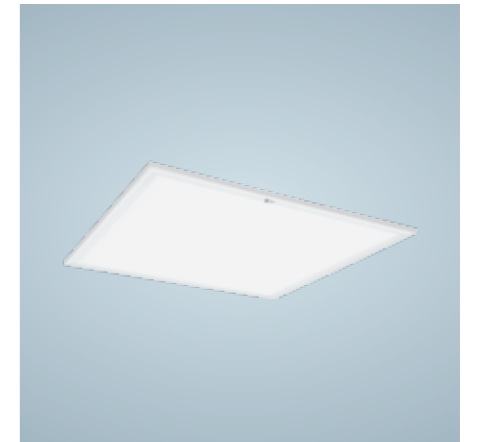

Front View

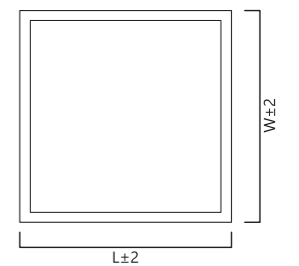

Side View

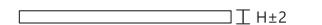

RECOMMENDED USAGE

• Offices • BPOs • Hospitals • Banks • Meeting Rooms • Other Indoor Applications

TECHNICAL DETAILS

Model No.	System Wattage	Rated CCT	CRI	Rated Voltage	Power Factor	Dimensions (in mm)		
						L	W	H
LTRHD-24-C	24W	6500K	≥80	240V AC	≥0.95	295	295	14

CCT's are available in Cool white, Neutral white & Warm white.



AQUA SURFACE 2X2

Surface-mounting back-lit LED 2x2 tile in CRCA housing with full opal diffuser for soft & glare-free light distribution.

PRODUCT SPECIFICATIONS

Housing

CRCA powder-coated white after phosphochromate treatment.

Optics

High transmittance opal diffuser for glare free uniform light distribution. High lumen efficacy LED with viewing angle of 120° used to enhance the lumen output.

Mounting

Surface-mounting.

Control Gear

Powered by an independent electronic LED driver with Output Short-Circuit Protection, Surge Protection & other reliability tests.

Surge Protection

Up to 2.5 KV

IP

20

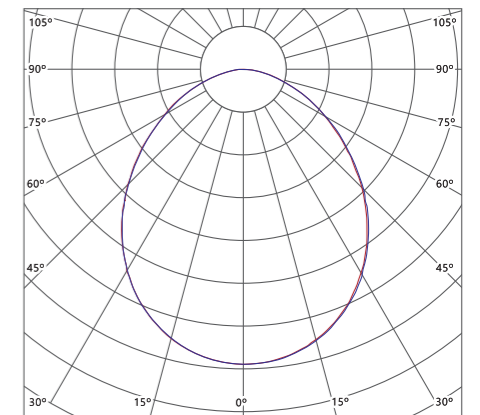
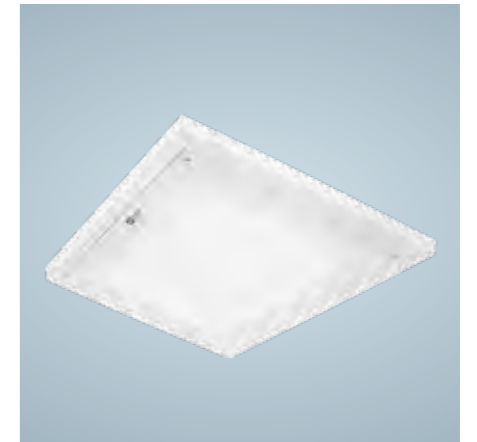

Front View

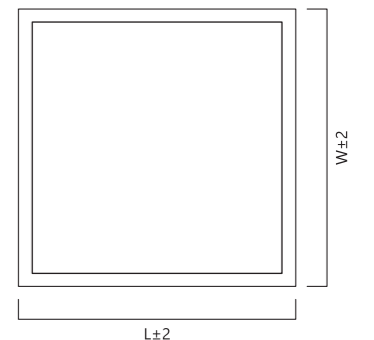

Side View



RECOMMENDED USAGE

• Offices • BPOs • Hospitals • Banks • Meeting Rooms • Other Indoor Applications

TECHNICAL DETAILS

Model No.	System Wattage	Rated CCT	CRI	Rated Voltage	Power Factor	Dimensions (in mm)		
						L	W	H
LTSAQ-36-C	36W	6500K	≥80	240V AC	≥0.95	595	595	80

CCT's are available in Cool white, Neutral white & Warm white.

AQUA SURFACE 1X4

Surface-mounting back-lit LED 1x4 tile in CRCA housing with full opal diffuser for soft & glare-free light distribution.

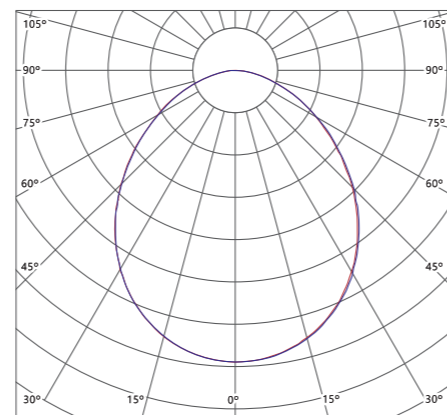

Front View

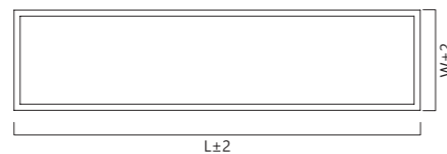

Side View

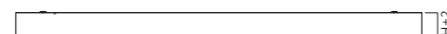

PRODUCT SPECIFICATIONS

Housing

CRCA powder-coated white after phosphochromate treatment.

Optics

High transmittance opal diffuser for glare free uniform light distribution. High lumen efficacy LED with viewing angle of 120° used to enhance the lumen output.

Mounting

Surface-mounting.

Control Gear

Powered by an independent electronic LED driver with Output Short-Circuit Protection, Surge Protection & other reliability tests.

Surge Protection

Up to 2.5 KV

IP

20

RECOMMENDED USAGE

• Offices • BPOs • Hospitals • Banks • Meeting Rooms • Other Indoor Applications

TECHNICAL DETAILS

Model No.	System Wattage	Rated CCT	CRI	Rated Voltage	Power Factor	Dimensions (in mm)		
						L	W	H
LTSAQ-36-C-1X4	36W	6500K	≥80	240V AC	≥0.95	1195	295	80

CCT's are available in Cool white, Neutral white & Warm white.

DLINE RECESS

Seamless aluminium extruded recess-mounting luminaire for indoor architectural lighting solution for continuous mounting. Offers excellent energy-saving and maintenance-free operation featured with best-in-class LED light sources having high luminous efficacy and highly translucent optical system to ensure maximum light output with excellent glare control and uniformity.

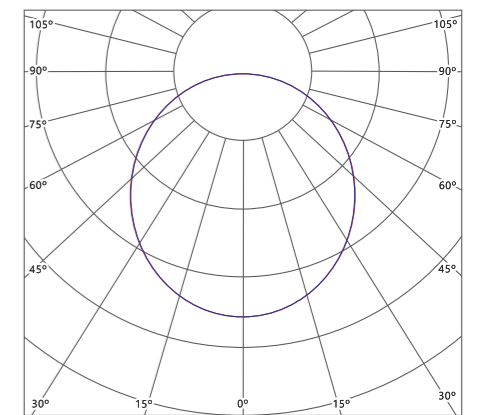

Side View

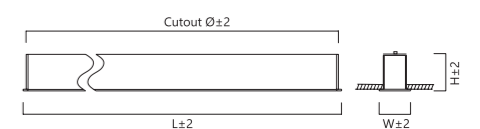

PRODUCT SPECIFICATIONS

Housing

Aluminum extruded housing in white powder-coated finish and plastic moulded end caps.

Optics

High transmittance opal diffuser for glare free uniform light distribution. High lumen efficacy LED with viewing angle of 120° used to enhance the lumen output.

Mounting

Suitable for Recess-mounting. Can be installed in continuous mounting using joining kits.

Control Gear

Powered by an independent electronic LED driver with Output Short-Circuit Protection, Surge Protection & other reliability tests.

Surge Protection

Up to 2.5 KV

IP

20

RECOMMENDED USAGE

• Offices • BPOs • Hospitals • Banks • Meeting Rooms • Other Indoor Applications

TECHNICAL DETAILS

Model No.	System Wattage	Rated CCT	CRI	Rated Voltage	Power Factor	Dimensions (in mm)		
						LxW	Ø	H
LCRD-28-C-66	28W	6500K	≥80	240V AC	≥0.95	1211x66	1202x54	38
LCRD-56-C-66	56W	6500K	≥80	240V AC	≥0.95	2411x66	2402x54	38
LCRD-36-C-90	36W	6500K	≥80	240V AC	≥0.95	1211x90	1202x82	38
LCRD-72-C-90	72W	6500K	≥80	240V AC	≥0.95	2411x90	2402x82	38

CCT's are available in Cool white, Neutral white & Warm white.

DLINE TZ

High-efficiency energy-saving LED recess-mounting luminaire with premium powder-coating and robust electronics makes it the ideal choice for office lighting for continuous mounting. Featured with the best-in-class LED light sources having high luminous efficacy and highly translucent optical system to ensure maximum light output with excellent glare control and uniformity. Suitable for architectural lighting for TechZone ceiling.

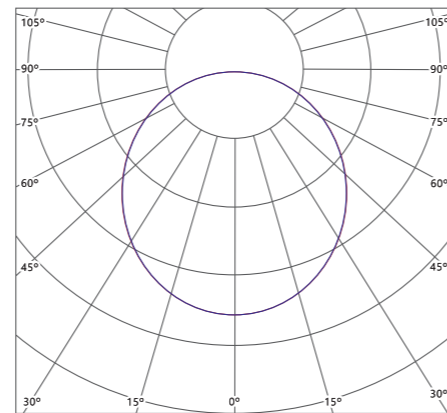

Side View

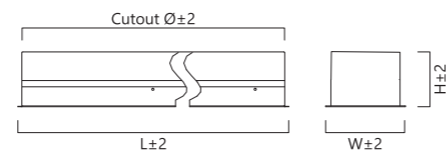

PRODUCT SPECIFICATIONS

Housing

Housing in aluminium extrusion in white powder-coated finish and metal end caps.

Optics

High transmittance opal diffuser for glare free uniform light distribution. High lumen efficacy LED with viewing angle of 120° used to enhance the lumen output.

Mounting

Suitable for recess mounting in TechZone ceiling.

Control Gear

Powered by an independent electronic LED driver with Output Short-Circuit Protection, Surge Protection & other reliability tests.

Surge Protection

Up to 2.5 KV

IP

20

RECOMMENDED USAGE

• Offices • BPOs • Hospitals • Banks • Meeting Rooms • Other Indoor Applications

TECHNICAL DETAILS

Model No.	System Wattage	Rated CCT	CRI	Rated Voltage	Power Factor	Dimensions (in mm)		
						LxW	Ø	H
LCRDL-28-C-TZ	28W	6500K	≥80	240V AC	≥0.95	1200 x 135	1185 x 115	90
LCRDL-56-C-TZ	56W	6500K	≥80	240V AC	≥0.95	2400 x 135	2385 x 115	90

CCT's are available in Cool white, Neutral white & Warm white.



DLINE

Seamless LED aluminium extruded suspended luminaire for indoor architectural lighting solution. Offers excellent energy- saving and maintenance-free operation, suitable for continuous mounting linear lighting system. It enhances visual ambience with uniform illumination.

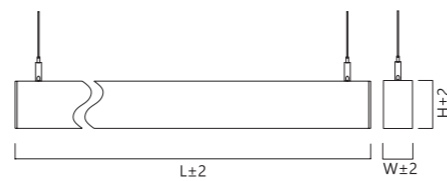
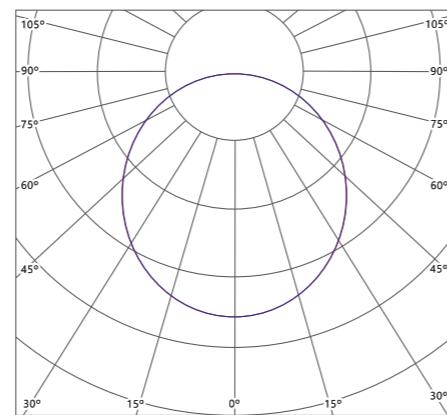

Side View

PRODUCT SPECIFICATIONS

Housing

Aluminium extruded housing in white powder-coated finish and plastic-moulded end caps.

Optics

High transmittance opal diffuser for glare free uniform light distribution. High lumen efficacy LED with viewing angle of 120° used to enhance the lumen output.

Mounting

Suitable for suspended/surface mounting with height-adjustable suspension kit. Can be installed in continuous mounting using joining kits.

Control Gear

Powered by an independent electronic LED driver with Output Short-Circuit Protection, Surge Protection & other reliability tests.

Surge Protection

Up to 2.5 KV

IP

20

RECOMMENDED USAGE

•Offices • BPOs • Hospitals • Banks • Meeting Rooms • Other Indoor Applications

TECHNICAL DETAILS

Model No.	System Wattage	Rated CCT	CRI	Rated Voltage	Power Factor	Dimensions (in mm)		
						L	W	H
LCPDL-14-C-54	14W	6500K	≥80	240V AC	≥0.95	600	54	73
LCPDL-28-C-54	28W	6500K	≥80	240V AC	≥0.95	1200	54	73
LCPDL-56-C-54	56W	6500K	≥80	240V AC	≥0.95	2400	54	73
LCPDL-18-C-75	18W	6500K	≥80	240V AC	≥0.95	600	75	85
LCPDL-36-C-75	36W	6500K	≥80	240V AC	≥0.95	1200	75	85
LCPDL-72-C-75	72W	6500K	≥80	240V AC	≥0.95	2400	75	85

CCT's are available in Cool white, Neutral white & Warm white..

UDLINE

Suspended, seamless LED up-downlight luminaire in extruded aluminium for indoor architectural lighting solution, offering excellent energy-saving and maintenance-free operation. Luminaires can be connected end-to-end to make a continuous lighting system of any length to uplift the visual ambience.

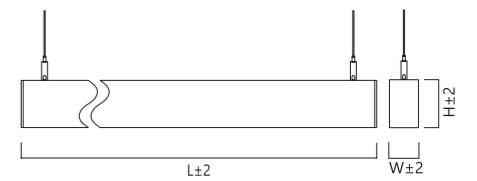
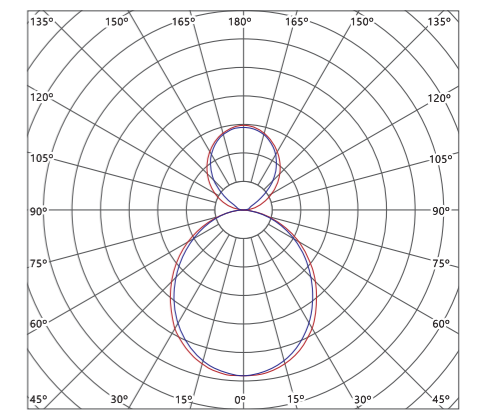

Side View

PRODUCT SPECIFICATIONS

Housing

Aluminium extruded housing in white powder-coated finish and plastic-moulded end caps.

Optics

High transmittance opal diffuser for glare free uniform light distribution. High lumen efficacy LED with viewing angle of 120° used to enhance the lumen output.

Mounting

Suitable for suspended/surface mounting with height-adjustable suspension kit. Can be installed in continuous mounting using joining kits.

Control Gear

Powered by an independent electronic LED driver with Output Short-Circuit Protection, Surge Protection & other reliability tests.

Surge Protection

Up to 2.5 KV

IP

20

RECOMMENDED USAGE

•Offices • BPOs • Hospitals • Banks • Meeting Rooms • Other Indoor Applications

TECHNICAL DETAILS

Model No.	System Wattage	Rated CCT	CRI	Rated Voltage	Power Factor	Dimensions (in mm)		
						L	W	H
LCPUD-28-C-1-EI	8W+20W	6500K	≥80	240V AC	≥0.95	1200	54	73
LCPUD-56-C-2-EI	16W+40W	6500K	≥80	240V AC	≥0.95	2400	54	73

CCT's are available in Cool white, Neutral white & Warm white.



RETAIL LIGHTING

NUCLEUS RECESS

Recess-mounted adjustable LED downlights made of extruded aluminium housing and high-power COB LED as a light source with clear diffuser and a separate electronic driver.

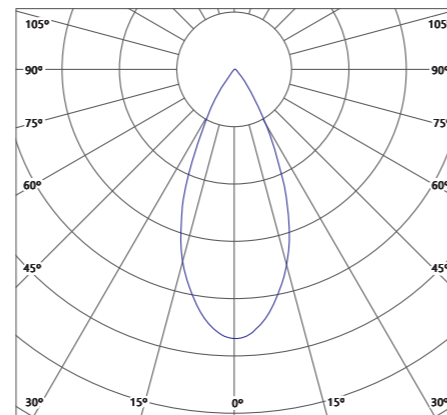

Front View

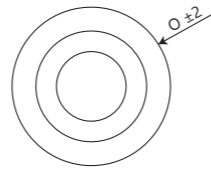

Side View

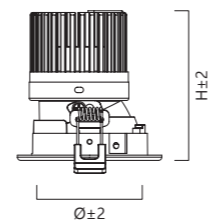

PRODUCT SPECIFICATIONS

Housing

Extruded aluminium heat sink for efficient heat dissipation with clear diffuser.

Optics

High-efficiency and long-life COB LED with high lumen efficacy. High-purity anodised glossy stepped-type reflector to enhance the lumen output of the fixture. Available in narrow and wide beam angles.

Mounting

Fix into false ceiling with spring clamps provided with the fixture.

Control Gear

Powered by an independent isolated electronic driver in ABS housing with Output Short-Circuit Protection, Over Voltage Protection, Surge Voltage Protection and other safety tests.

Surge Protection

Up to 2.5 KV

IP

20

RECOMMENDED USAGE

- Corporate Offices • Restaurants • Hotel • Waiting Areas • Modern Gym & Spa • Corporate Offices

TECHNICAL DETAILS

Model No.	System Wattage	Rated CCT	CRI	Rated Voltage	Power Factor	Dimensions (in mm)		
						Ø	Ø	H
LDRNS-03-C	3W	6500K	≥80	240V AC	≥0.9	65	52	40
LDRNS-06-C	6W	6500K	≥80	240V AC	≥0.9	90	77	53
LDRNS-010-C	10W	6500K	≥80	240V AC	≥0.9	90	77	53
LDRNS-015-C	15W	6500K	≥80	240V AC	≥0.9	115	95	75
LDRNS-020-C	20W	6500K	≥80	240V AC	≥0.9	115	95	75
LDRNS-025-C	25W	6500K	≥80	240V AC	≥0.9	134	122	105
LDRNS-030-C	30W	6500K	≥80	240V AC	≥0.9	160	148	115

CCT's are available in Cool white, Neutral white & Warm white.

NUCLEUS DEEP RECESS

Recess-mounted LED downlights made of die-cast aluminium housing and high-power LED as a light source with clear diffuser and a separate electronic driver.

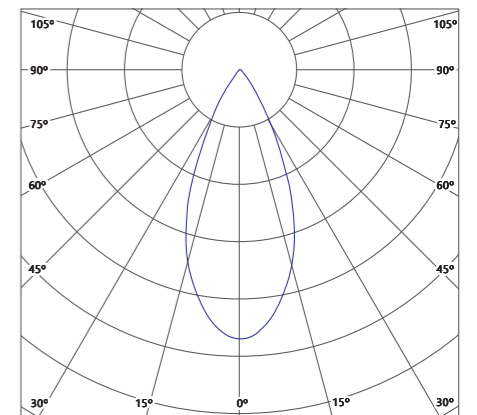

Front View

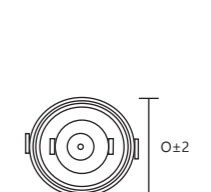

Side View

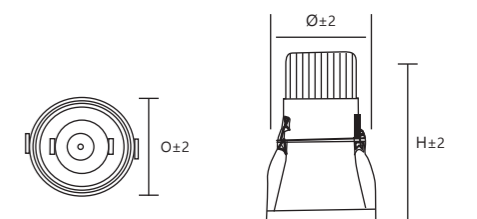

PRODUCT SPECIFICATIONS

Housing

Pressure die-cast aluminium heat sink for efficient heat dissipation with clear diffuser.

Optics

High-efficiency and long-life deep recess COB LED with high lumen efficacy. High-purity anodised glossy stepped type reflector to enhance the lumen output of the fixture.

Mounting

Fix into false ceiling by means of spring & clips provided

Control Gear

Powered by an independent electronic LED driver with Output Short-circuit protection, Surge protection & other reliability tests.

Surge Protection

Up to 2.5 KV

IP

20

RECOMMENDED USAGE

- Retail Stores • Resturants • Hotel Lobbies • Waiting Areas • Corporate Offices

TECHNICAL DETAILS

Model No.	System Wattage	Rated CCT	CRI	Rated Voltage	Power Factor	Dimensions (in mm)		
						Ø	Ø	H
LDRND-06-C	6W	6500K	≥80	240V AC	≥0.9	55	45	92
LDRND-010-C	10W	6500K	≥80	240V AC	≥0.9	76	70	99
LDRND-012-C	12W	6500K	≥80	240V AC	≥0.9	76	70	99
LDRND-015-C	15W	6500K	≥80	240V AC	≥0.9	92	85	117
LDRND-020-C	20W	6500K	≥80	240V AC	≥0.9	92	85	117
LDRND-025-C	25W	6500K	≥80	240V AC	≥0.9	128	122	128

CCT's are available in Cool white, Neutral white & Warm white.

NUCLEUS SURFACE

Cylindrical surface-mounting round LED downlighter designed with excellent thermally managed aluminium pressure die-cast housing finished in epoxy powder-coated white to deliver high efficacy light output and uniformity, utilising COB technology.

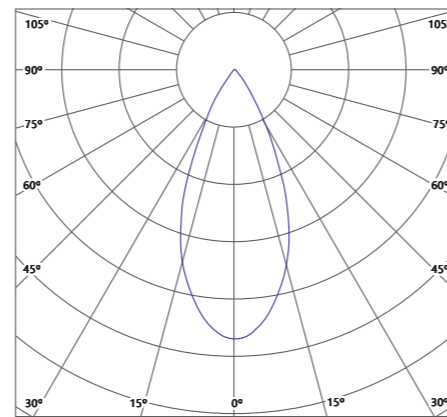

Front View

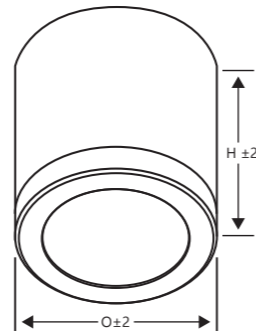

PRODUCT SPECIFICATIONS

Housing

Pressure die-cast aluminium heat sink for efficient heat dissipation with clear diffuser.

Optics

High-efficiency and long-life COB LED with high lumen efficacy. High-purity anodised glossy stepped type reflector to enhance the lumen output of the fixture.

Mounting

Surface-mounted.

Control Gear

Powered by an independent electronic driver with Output Short Circuit protection, Over Voltage protection, Surge Voltage protection and other safety tests.

Surge Protection

Up to 2.5 KV

IP

20

RECOMMENDED USAGE

• Corporate Offices • Restaurants • Hotels • Waiting Areas • Modern Gym & Spa

TECHNICAL DETAILS

Model No.	System Wattage	Rated CCT	CRI	Rated Voltage	Power Factor	Dimensions (in mm)	
						O	H
LDSNS-010-C	10W	6500K	≥80	240V AC	≥0.9	70	125
LDSNS-015-C	15W	6500K	≥80	240V AC	≥0.9	100	148
LDRNS-020-C	20W	6500K	≥80	240V AC	≥0.9	100	148

CCT's are available in Cool white, Neutral white & Warm white.

WALL WASHER

LED recessed adjustable downlight made up of high-grade aluminium die-cast housing with spectacular reflector with 36° beam angle. It is featured with advanced COB LED with adjustable focus.

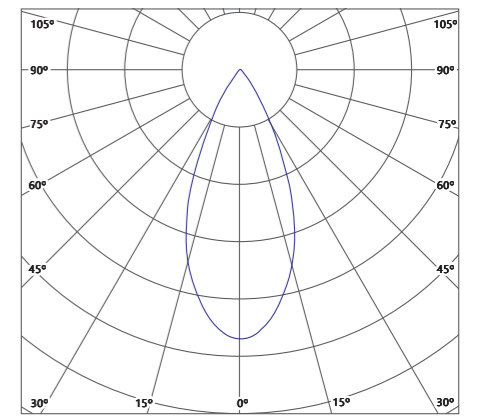

Side View

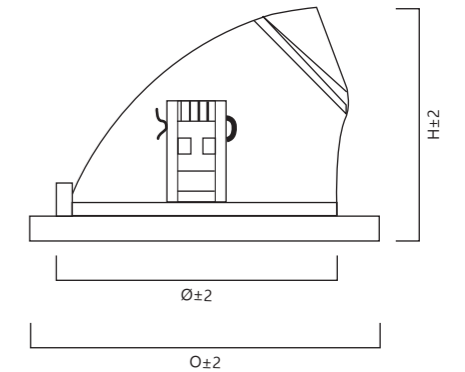

PRODUCT SPECIFICATIONS

Housing

Powder coated white pressure die-cast aluminium housing for efficient thermal management with angle adjustment.

Optics

High purity aluminium sputtered stepped type reflector with clear diffuser, 36° beam angle available.

Mounting

Fix into false ceiling by means of spring & clips provided.

Control Gear

Powered by a separate electronic driver with Output Short Circuit Protection, Surge Voltage Protection and other reliability tests.

Surge Protection

Up to 2.5 KV

IP

20

RECOMMENDED USAGE

• Showrooms • Reception & Public Service Areas • Waiting Lounges
• Breakout Zones • Corridors

TECHNICAL DETAILS

Model No.	System Wattage	Rated CCT	CRI	Rated Voltage	Power Factor	Dimensions (in mm)		
						O	Ø	H
LDRWS-25-C	25W	6500K	≥80	240V AC	≥0.9	152	142	122

CCT's are available in Cool white, Neutral white & Warm white.

LED TRACK LIGHT

Track-based spot light with high-efficiency reflector makes it ideal for lighting up retail spaces with bright and crisp light.

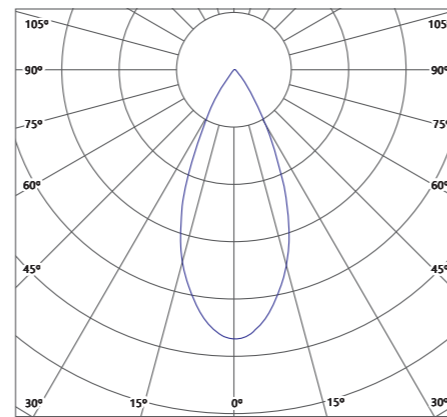

Front View

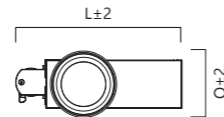

Side View

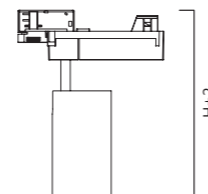

PRODUCT SPECIFICATIONS

Housing

Pressure die-cast aluminium housing (heat sink) with powder-coated white finish.

Optics

High-efficiency and long-life COB LED with high lumen efficacy. Available in narrow and wide beam angles with 355° swivel and 90° elbow tilt.

Mounting

Track-mounted.

Control Gear

Powered by an inbuilt electronic LED driver.

Surge Protection

Up to 2.5 KV

IP

20

RECOMMENDED USAGE

- Retail Stores • Hypermarkets • Hotel Lobbies • Waiting Areas
- Restaurants • Museums

TECHNICAL DETAILS

Model No.	System Wattage	Rated CCT	CRI	Rated Voltage	Power Factor	Dimensions (in mm)		
						L	O	H
LTSTL-20-C	20W	6500K	≥80	240V AC	≥0.9	203	100	201
LTSTL-30-C	30W	6500K	≥80	240V AC	≥0.9	203	100	201

Track rail to be ordered separately.
CCT's are available in Cool white, Neutral white & Warm white.

LED STRIP LIGHT

Flexible LED strip uses high-brightness SMD LED as the light source (for indoor application only). It is highly suitable for cove-lighting, decorative lighting, etc.

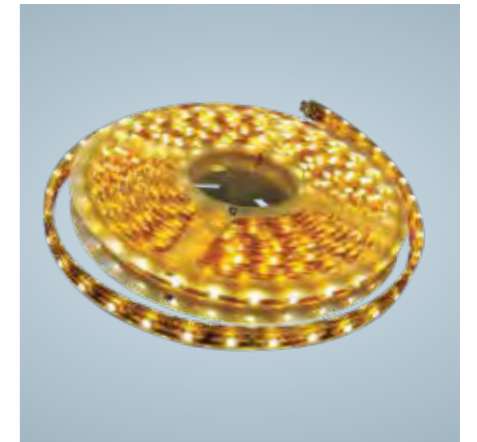

Front View

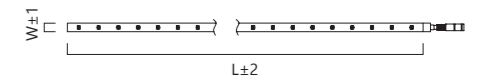

PRODUCT SPECIFICATIONS

Housing

Flexible PCB, fits in any shape.

Mounting

Tape is used at the back of the strip to mount it.

Control Gear

Powered by a separate electronic driver with Output Short-Circuit Protection, Surge Voltage Protection and other. Reliability tests.

Surge Protection

Up to 2.5 KV

IP

20

RECOMMENDED USAGE

- Banks & Back Offices • Reception & Public Service Areas • Waiting Lounge
- Meeting Rooms • Corridors

TECHNICAL DETAILS

Model No.	System Wattage	Rated CCT	CRI	Rated Voltage	Power Factor	Dimensions (in mm)	
						L	W
LSTRIP-24-C	24W	6500K	≥80	240V AC	-	5000	10

Driver to be ordered separately.
CCT's are available in Cool white, Neutral white & Warm white.



INDUSTRIAL LIGHTING

TASKLINE IND

LED batten in robust Aluminium housing is an ideal replacement solution for existing battens/fluorescent lamps.

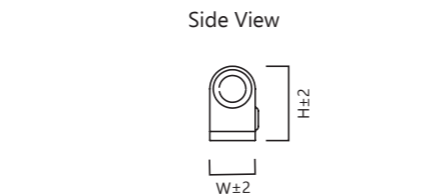
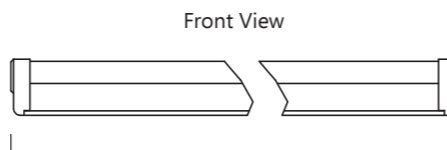
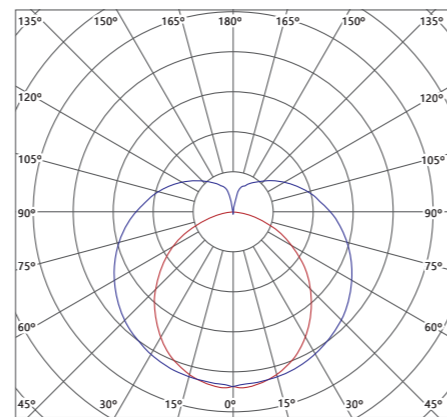

PRODUCT SPECIFICATIONS

Housing

Epoxy powder-coated aluminium housing for efficient heat dissipation. Elegantly designed end caps to enhance the aesthetic view of the fixture.

Optics

High transmittance opal diffuser for glare free uniform light distribution. High lumen efficacy LED with viewing angle of 120° used to enhance the lumen output.

Mounting

Fix directly into the wall/ceiling by means of mounting SS clips, provided with the fixture.

Control Gear

Powered by an integral electronic driver with Output Short-Circuit Protection, surge Protection & other safety tests.

Surge Protection

Up to 3 KV

IP

40

RECOMMENDED USAGE

- Commercial Buildings • Residential Buildings • Industrial Applications
- Other Indoor Applications

TECHNICAL DETAILS

Model No.	System Wattage	Rated CCT	CRI	Rated Voltage	Power Factor	Dimensions (in mm)		
						L	W	H
LBLN-40-C-IND	40W	5700K	≥80	240V AC	≥0.95	1136	45	55

CCT's are available in Cool white, Neutral white & Warm white.

VAPORPROOF

Energy-saving, long-life, corrosion-resistant, impact proof, surface/suspended-mounting luminaires with PC housing and linear ribbed PC cover for glare-free light; suitable for T8 LED tube.

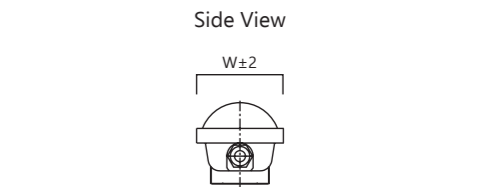
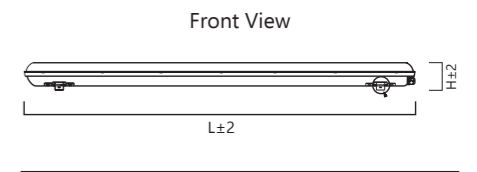

PRODUCT SPECIFICATIONS

Housing

Made up of corrosion-resistant unbreakable polycarbonate.

Optics

Clear polycarbonate cover with better light-dispersive internal reeds fixed to the housing by means of SS toggles.

Mounting

Fix directly into the wall/ceiling by means of mounting SS clips, provided with the fixture.

IP

65

RECOMMENDED USAGE

- Chemical Plants • Stores • Food & Beverage Industry • Other Industrial Applications

TECHNICAL DETAILS

Model No.	System Wattage LED TUBE*	Rated CCT	CRI	Rated Voltage	Power Factor	Dimensions (in mm)		
						L	W	H
LIVP-118-DS	1x18W T8	-	-	240V AC	-	1300	70	60
LIVP-218-DS	2x18W T8	-	-	240V AC	-	1300	110	60

*Tubes to be ordered separately.



VAPORPROOF-I

Energy-saving, long-life, corrosion-resistant, impact-proof, surface/suspended mounting luminaires with PC housing and PC cover for glare-free light.

PRODUCT SPECIFICATIONS

Housing

Made up of scratch-resistant unbreakable polycarbonate in grey finish. Cable gland used for maintaining ingress protection. High-quality polycarbonate diffuser in opal finish for glare-free uniform light distribution, snap-fitted to the housing.

Optics

High transmittance opal diffuser for glare free uniform light distribution. High lumen efficacy LED with viewing angle of 120° used to enhance the lumen output.

Mounting

Fix directly into the wall/ceiling by means of mounting SS clips, provided with the fixture.

Control Gear

Powered by an integral electronic driver with Output Short-Circuit Protection, Surge Protection & other safety tests.

Surge Protection

Up to 3 KV

IP

65

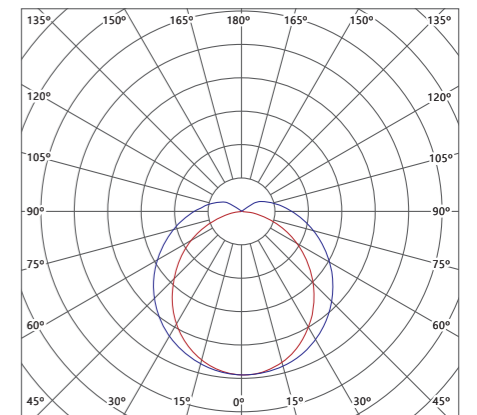

Front View

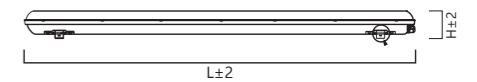

Side View

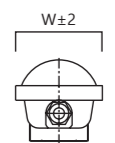

RECOMMENDED USAGE

- Chemical Plants • Stores • Food & Beverage Industry • Other Industrial Applications

TECHNICAL DETAILS

Model No.	System Wattage	Rated CCT	CRI	Rated Voltage	Power Factor	Dimensions (in mm)		
						L	W	H
LIVP-36-C	36W	6500K	≥80	240V AC	≥0.95	1140	75	70

CCT's are available in Cool white, Neutral white & Warm white.



KRYPTON

Energy-saving long-life corrosion-resistant, vertical surface-mounting pressure die-cast aluminium housing integral well glass luminaires with high-lumen LED as light source.

PRODUCT SPECIFICATIONS

Housing

Pressure die-cast aluminium alloy housing (heat sink) for effective thermal management, sturdiness & excellent corrosion-resistance; cable gland is provided at cable entry for maintaining ingress protection and for providing loop-in & loop-out facility. Epoxy powder-coated finish.

Optics

High transmittance opal diffuser for glare free uniform light distribution. High lumen efficacy LED with viewing angle of 120° used to enhance the lumen output.

Mounting

Suspended by means of eye-bolt provided with the fixture.

Control Gear

Powered by an integral electronic driver with Output Short-Circuit Protection, Surge Protection & other safety tests.

Surge Protection

Up to 4 KV (internal)

IP

65

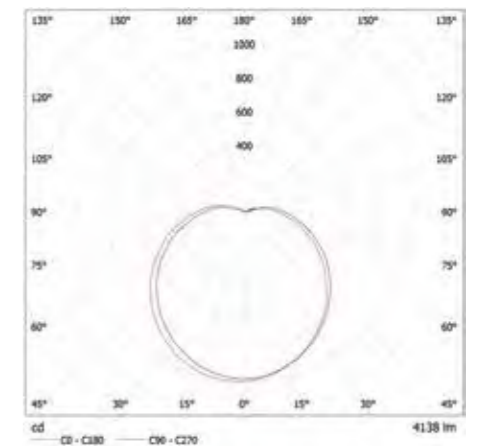

Front View

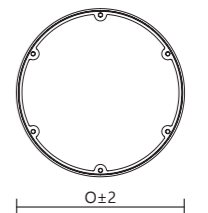

Side View

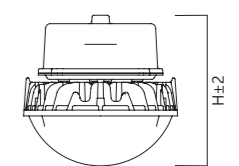

RECOMMENDED USAGE

• Cement Plants • Power Plants • Conveyor Belts • Material Handling Areas

TECHNICAL DETAILS

Model No.	System Wattage	Rated CCT	CRI	Rated Voltage	Power Factor	Dimensions (in mm)	
						O	H
LWKT-30-C	25W	5700K	≥70	240V AC	≥0.95	154	143
LWKT-36-C	30W	5700K	≥70	240V AC	≥0.95	154	143
LWKT-40-C	40W	5700K	≥70	240V AC	≥0.95	154	143
LWKT-45-C	45W	5700K	≥70	240V AC	≥0.95	154	143
LWKT-60-C	60W	5700K	≥70	240V AC	≥0.95	190	208
LWKT-70-C	70W	5700K	≥70	240V AC	≥0.95	190	208

CCT's are available in Cool white, Neutral white & Warm white.

NEUTRON

Energy-saving long-life corrosion-resistant, vertical surface-mounting pressure die-cast aluminium housing and control gear compartment well glass luminaires with high-power LED as light source.

PRODUCT SPECIFICATIONS

Housing

Pressure die-cast aluminium alloy housing (heat sink) for effective thermal management, sturdiness & excellent corrosion-resistance. Epoxy powder coated finish.

Optics

High transmittance opal diffuser for glare free uniform light distribution. High lumen efficacy LED with viewing angle of 120° used to enhance the lumen output.

Mounting

Suspended by means of eye-bolt provided with the fixture.

Control Gear

Powered by an integral electronic driver with Output Short-Circuit Protection, Surge Protection & other safety tests.

Surge Protection

Up to 4 KV (internal); optional 10 KV external SPD.

IP

66

RECOMMENDED USAGE

• Cement Plants • Power Plants • Conveyor Belts • Material Handling Areas

TECHNICAL DETAILS

Model No.	System Wattage	Rated CCT	CRI	Rated Voltage	Power Factor	Dimensions (in mm)	
						O	H
LWNT-35-C	35W	5700K	≥70	240V AC	≥0.95	154	229

CCT's are available in Cool white, Neutral white & Warm white.

HIGH LUMEN OUTPUT

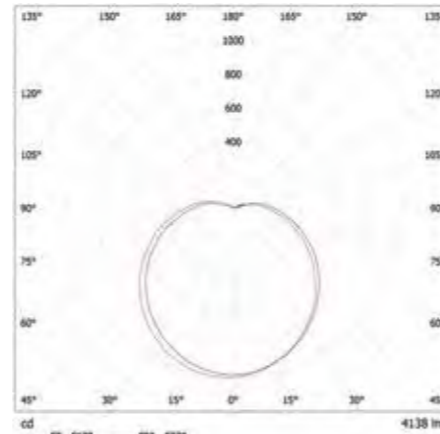

Side View

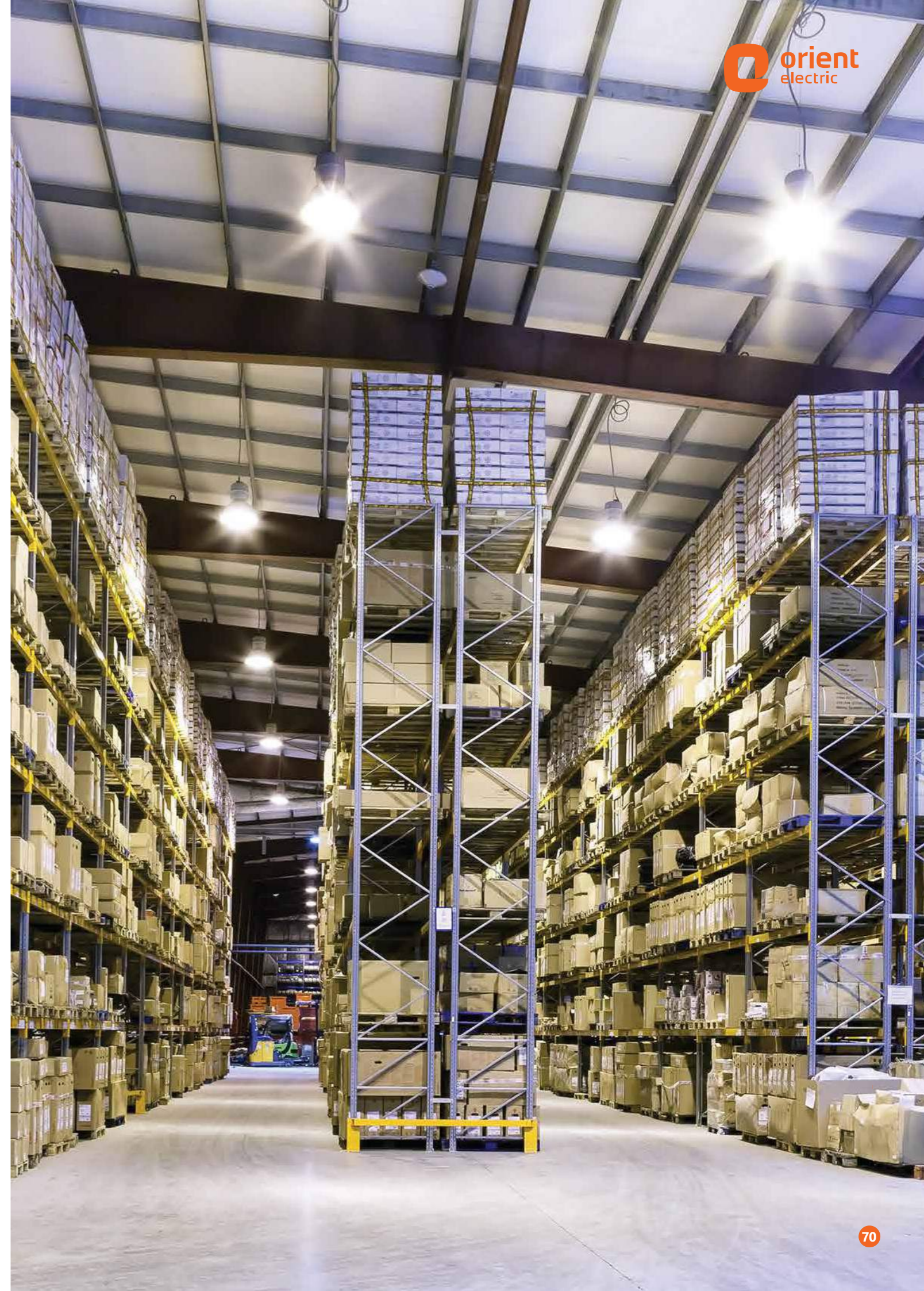
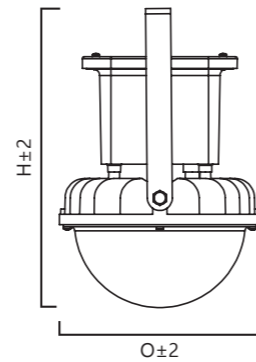

VERTEX SPIRAL

LED Highbay with high efficacy of 110 lm/W designed with excellent thermally managed aluminium die cast housing having heat dissipating fins for larger surface area, satin finish powder coating and fitted with polycarbonate lens diffuser in the front for the desired Ingress Protection.

PRODUCT SPECIFICATIONS

Housing

Excellent thermally managed Pressure die cast aluminum.

Optics

PC Lens Cluster Cover with 60° Beam Angle.

Mounting

Eyebolt.

Control Gear

Powered by independent electronic LED driver with Output Short-circuit protection, Surge protection & other reliability tests.

Surge Protection

Upto 4 KV (internal), optional 10KV SPD

IP

65

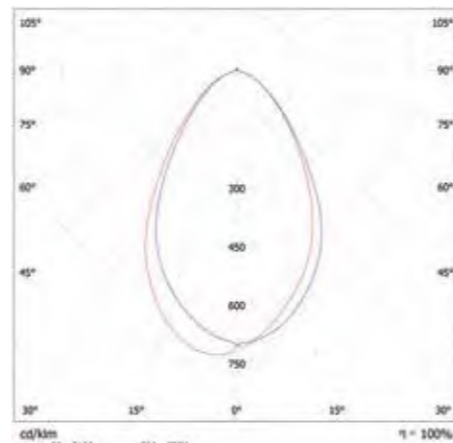
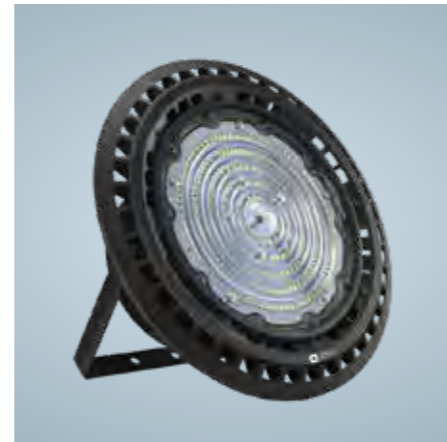

Side View

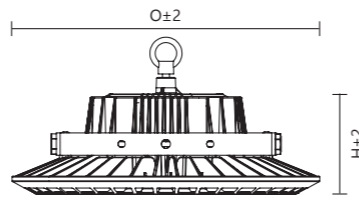

RECOMMENDED USAGE

• Warehouses • Industrial Sheds • Hyper/supermarkets

TECHNICAL DETAILS

Model No.	System Wattage	Rated CCT	CRI	Rated Voltage	Power Factor	Dimensions (in mm)	
						O	H
LHVXS-080-C	80W	5700K	≥70	240V AC	≥0.95	292	135
LHVXS-100-C	100W	5700K	≥70	240V AC	≥0.95	292	135
LHVXS-120-C	120W	5700K	≥70	240V AC	≥0.95	292	135
LHVXS-150-C	150W	5700K	≥70	240V AC	≥0.95	344	109
LHVXS-180-C	180W	5700K	≥70	240V AC	≥0.95	400	165
LHVXS-200-C	200W	5700K	≥70	240V AC	≥0.95	400	165

CCT's are available in Cool white, Neutral white & Warm white.

PINNACLE

LED Highbay with high efficacy of 110 lm/W designed with excellent thermally managed aluminium die cast housing having heat dissipating fins for larger surface area, satin finish powder coating and fitted with toughened glass in the front.

PRODUCT SPECIFICATIONS

Housing

Pressure die-cast housing & control gear box for better heat dissipation and aesthetic appeal. Gland is used for cable entry. The fixture is epoxy powder-coated for smooth finish.

Optics

High-quality PC lens with optional beam angles 60° & 90° for uniform distribution. High lumen efficacy LED with viewing angle of 120° used to enhance the lumen output.

Mounting

Bracket mounting

Control Gear

Powered by an integral electronic driver with output Short-Circuit Protection, Surge Protection & other safety tests.

Surge Protection

Up to 4 KV (Internal), Optional 10 KV external SPD.

IP

65

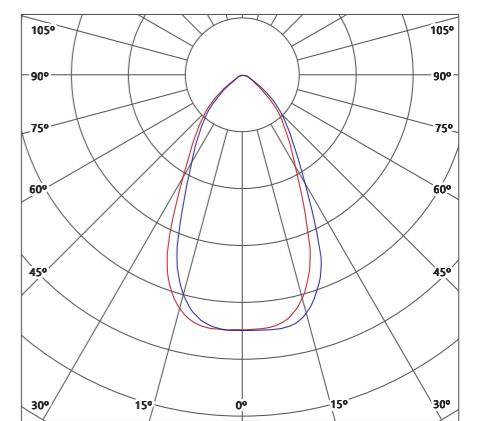

Front View

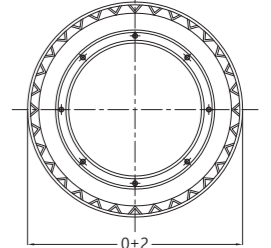

Side View

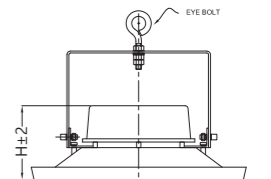

RECOMMENDED USAGE

• Warehouses • Industrial Sheds • Manufacturing Units

TECHNICAL DETAILS

Model No.	System Wattage	Rated CCT	CRI	Rated Voltage	Power Factor	Dimensions (in mm)	
						O	H (without bracket)
LHPN-080-C-V1	80W	5700K	≥70	240V AC	≥0.95	276	135
LHPN-100-C-V1	100W	5700K	≥70	240V AC	≥0.95	276	135
LHPN-120-C-V1	120W	5700K	≥70	240V AC	≥0.95	276	135
LHPN-150-C-V1	150W	5700K	≥70	240V AC	≥0.95	360	132
LHPN-180-C-V1	180W	5700K	≥70	240V AC	≥0.95	360	132
LHPN-200-C-V1	200W	5700K	≥70	240V AC	≥0.95	360	132

CCT's are available in Cool white, Neutral white & Warm white.

PINNACLE PLUS

LED Highbay with high efficacy of 130 lm/W designed with excellent thermally managed aluminium die cast housing having heat dissipating fins for larger surface area, satin finish powder coating and fitted with toughened glass in the front.

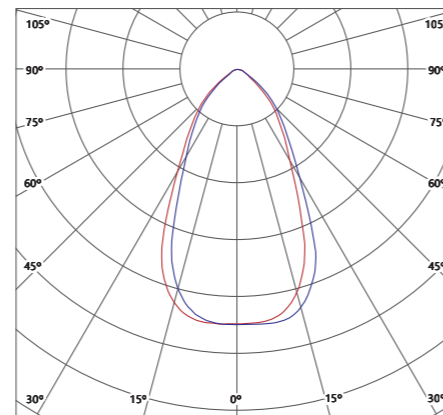

Front View

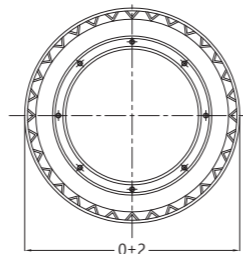

Side View

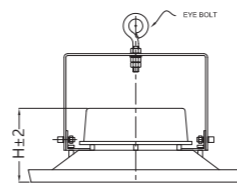

PRODUCT SPECIFICATIONS

Housing

Pressure die-cast housing & control gear box for better heat dissipation and aesthetic appeal. Gland is used for cable entry. The fixture is epoxy powder-coated with smooth finish.

Optics

High-quality PC lens with optional beam angles 60° & 90° for uniform distribution. High lumen efficacy LED with viewing angle of 120° used to enhance the lumen output.

Mounting

Bracket mounting.

Control Gear

Powered by an integral electronic driver with output Short-Circuit Protection, Surge Protection & other safety tests.

Surge Protection

Up to 4 KV (internal); optional 10 KV external SPD

IP

65

RECOMMENDED USAGE

• Warehouses • Industrial sheds • Hyper/supermarkets • Manufacturing units

TECHNICAL DETAILS

Model No.	System Wattage	Rated CCT	CRI	Rated Voltage	Power Factor	Dimensions (in mm)	
						O	H (without bracket)
LHPNP-080-C	80W	5700K	≥70	240V AC	≥0.95	285	120
LHPNP-100-C	100W	5700K	≥70	240V AC	≥0.95	285	120
LHPNP-120-C	120W	5700K	≥70	240V AC	≥0.95	285	120
LHPNP-150-C	150W	5700K	≥70	240V AC	≥0.95	385	127
LHPNP-180-C	180W	5700K	≥70	240V AC	≥0.95	385	127
LHPNP-200-C	200W	5700K	≥70	240V AC	≥0.95	385	127

CCT's are available in Cool white, Neutral white & Warm white.



CANOPY

Innovative design petrol pump/canopy lights with power LEDs as light source.

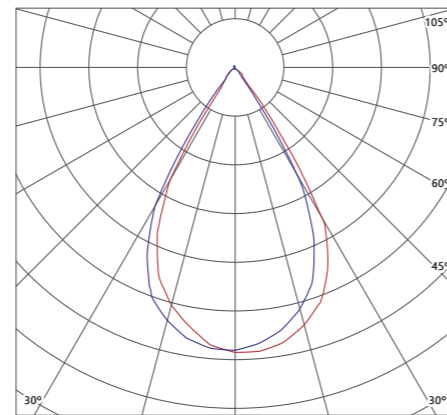
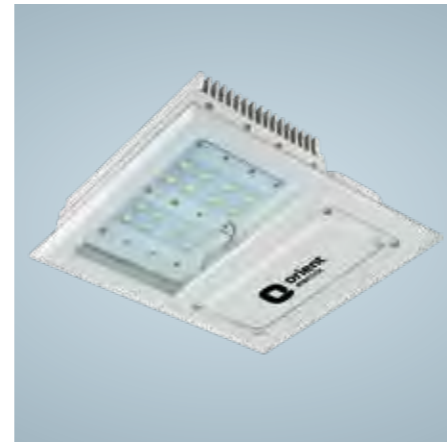

Front View

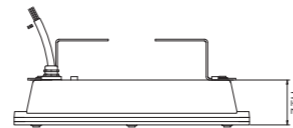

Side View

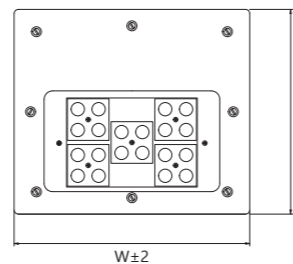

PRODUCT SPECIFICATIONS

Housing

Pressure die-cast aluminium housing with frame and elegantly designed extruded aluminium heat sink for efficient thermal management, sturdiness & excellent corrosion resistance.

Optics

High lumen efficacy LED with viewing angle of 120° used to enhance the lumen output.

Mounting

Recess-mounting.

Control Gear

Independent electronic driver, lower THD, open-circuit protection, over voltage protection, surge voltage protection & other safety tests.

Surge Protection

Up to 4 KV (internal)

IP

65

RECOMMENDED USAGE

• Petrol Pumps • Toll Plaza • Railway Platforms

TECHNICAL DETAILS

Model No.	System Wattage	Rated CCT	CRI	Rated Voltage	Power Factor	Dimensions (in mm)		
						L	W	H
LICP-080-C	80W	5700K	≥80	240V AC	≥0.95	283	246	55
LICP-100-C	100W	5700K	≥80	240V AC	≥0.95	283	246	55

CCT's are available in Cool white, Neutral white & Warm white.

CLEANLED-R-BO

Dust-free and zero-maintenance recess-mounting bottom-opening LED cleanroom luminaire.

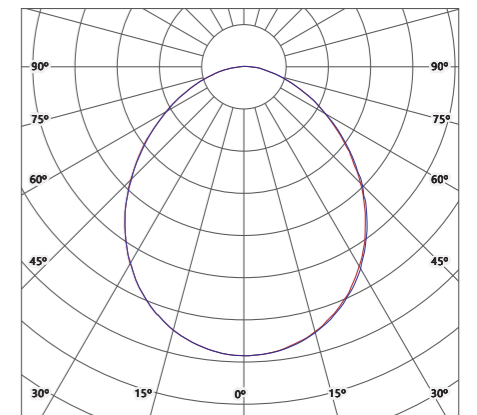

Front View

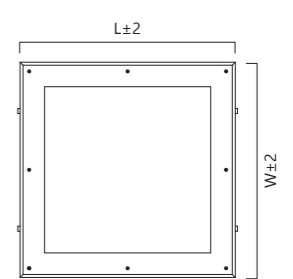

Side View

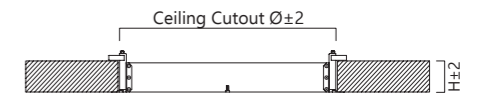

PRODUCT SPECIFICATIONS

Housing

MS powder-coated white housing having high-quality opal diffuser for glare-free uniform light distribution.

Optics

High transmittance opal diffuser for glare free uniform light distribution. High lumen efficacy LED with viewing angle of 120° used to enhance the lumen output.

Mounting

Recess-mounting.

Control Gear

Powered by an integral electronic driver with output short-Circuit Protection, Surge Protection & other safety tests.

Surge Protection

Up to 2.5 KV (internal)

IP

65 (From bottom)

RECOMMENDED USAGE

• Pharma Industry • Chemical & Biological Labs • Hospitals
• Food & Beverage Industry

TECHNICAL DETAILS

Model No.	System Wattage	Rated CCT	CRI	Rated Voltage	Power Factor	Dimensions (in mm)		
						LxW	Ø	H
LTRCL-24-C-BO	24W	6500K	≥80	240V AC	≥0.95	330x330	300x300	80
LTRCL-36-C-BO	36W	6500K	≥80	240V AC	≥0.95	595x595	575x575	80
LTRCL-45-C-BO	45W	6500K	≥80	240V AC	≥0.95	595x595	575x575	80
LTRCL-60-C-BO	60W	6500K	≥80	240V AC	≥0.95	595x595	575x575	80

CCT's are available in Cool white, Neutral white & Warm white.

CLEANLED-R-TO

Dust-free and zero-maintenance recess-mounting top openable LED cleanroom luminaire.

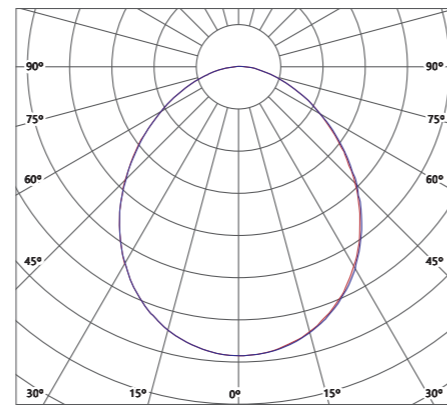

Front View

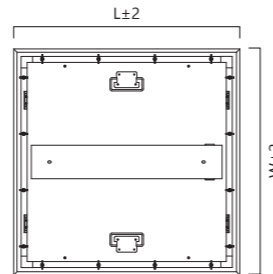

Side View

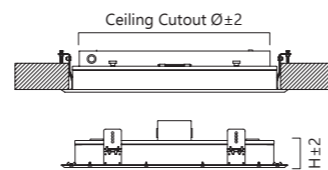

PRODUCT SPECIFICATIONS

Housing

MS powder-coated white housing having high-quality opal diffuser for glare-free uniform light distribution.

Optics

High transmittance opal diffuser for glare free uniform light distribution. High lumen efficacy LED with viewing angle of 120° used to enhance the lumen output.

Mounting

Recess-mounting.

Control Gear

Powered by an integral electronic driver with Output Short-Circuit Protection, Surge Protection & other safety tests.

Surge Protection

Up to 2.5 KV (internal)

IP

65 (From Top)

RECOMMENDED USAGE

- Pharma Industry • Chemical & Biological Labs • Hospitals
- Food & Beverage Industry

TECHNICAL DETAILS

Model No.	System Wattage	Rated CCT	CRI	Rated Voltage	Power Factor	Dimensions (in mm)		
						LxW	Ø	H
LTRCL-24-C-TO	24W	6500K	≥80	240V AC	≥0.95	330x330	300x300	80
LTRCL-36-C-TO	36W	6500K	≥80	240V AC	≥0.95	630x630	600x600	80
LTRCL-45-C-TO	45W	6500K	≥80	240V AC	≥0.95	630x630	600x600	80
LTRCL-60-C-TO	60W	6500K	≥80	240V AC	≥0.95	630x630	600x600	80

CCT's are available in Cool white, Neutral white & Warm white.

BULKHEAD PLUS

Ultra modern, energy saving, surface mounted, decorative oval bulk head edge-lit LED luminaires comprising of high brightness LEDs.

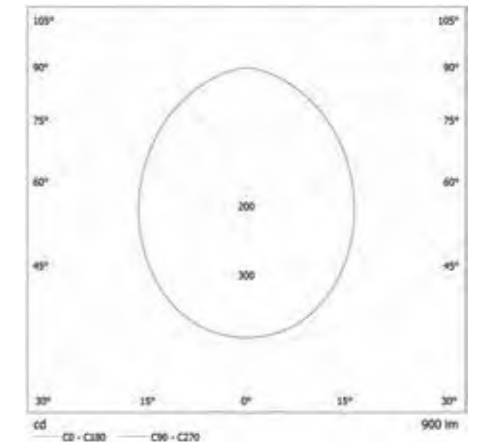

Side View

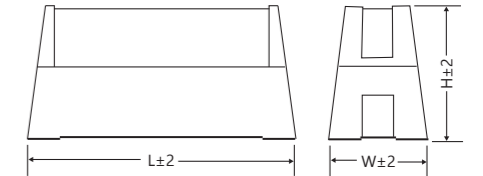

PRODUCT SPECIFICATIONS

Housing

Oval shaped pressure die-cast aluminium housing & ring for sturdiness & corrosion resistance. Epoxy powder coated white after phosphochromate treatment.

Optics

High transmittance opal diffuser for glare free uniform light distribution. High lumen efficacy LED with viewing angle of 120° used to enhance the lumen output.

Mounting

Wall/ceiling mounted by means of clamp with expansion screws provided.

Control Gear

Powered by built-in electronic LED driver with Output Short-circuit protection, Surge protection & other safety tests.

Surge Protection

Upto 2.5 KV(Internal)

IP

65

RECOMMENDED USAGE

- Staircases • Basements • Security Lighting

TECHNICAL DETAILS

Model No.	System Wattage	Rated CCT	CRI	Rated Voltage	Power Factor	Dimensions (in mm)		
						L	W	H
LIBHP-10-C	10W	5700K	≥70	240V AC	≥0.9	195	95	85

CCT's are available in Cool white, Neutral white & Warm white.



OUTDOOR LIGHTING

FEST

Highly efficient IP66 LED streetlight with aluminium pressure die cast housing toughened glass in the front and peanut lens for batwing light distribution to ensure uniform light distribution. Front maintainable driver compartment for easy maintenance.

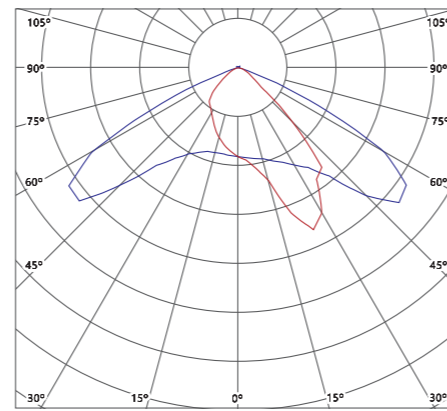

Front View

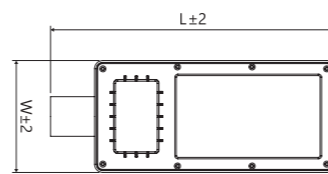

Side View

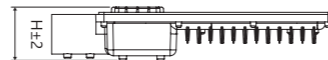

PRODUCT SPECIFICATIONS

Housing

Pressure die-cast aluminium alloy for housing (heat sink) for effective thermal management, sturdiness & excellent corrosion resistance. Cable gland used for maintaining ingress protection. Epoxy powder coated with smooth finish. Tempered protective toughened glass, thermal, shock and impact-resistant, fixed to the housing.

Optics

High lumen efficacy LED module with SMD LED package mounted with PC lens to ensure better uniformity of light distribution.

Mounting

Suitable for pole mounting with bracket arm.

Control Gear

Powered by an integral electronic driver with output short-circuit protection, surge protection & other safety tests.

Surge Protection

Upto 4 KV (Internal); Inbuilt 10KV external SPD

IP

66

RECOMMENDED USAGE

• Road Lighting • Campus Lighting • Industrial Estates • Open Parkings • Circulating Areas

TECHNICAL DETAILS

Model No.	System Wattage	Rated CCT	CRI	Rated Voltage	Power Factor	Dimensions (in mm)		
						L	W	H
LSFT-045-C	45W	5700K	≥70	240V AC	≥0.95	376	148	70
LSFT-060-C	60W	5700K	≥70	240V AC	≥0.95	376	148	70
LSFT-070-C	70W	5700K	≥70	240V AC	≥0.95	376	148	70

CCT's are available in Cool white, Neutral white & Warm white.

FIESTA

LED streetlight designed with excellent thermally managed aluminium pressure die cast housing having heat dissipating fins for larger surface area, matt finish powder coated in grey paint and fitted with polycarbonate cover in the front for the desired Ingress Protection. Front maintainable driver compartment for easy maintenance.

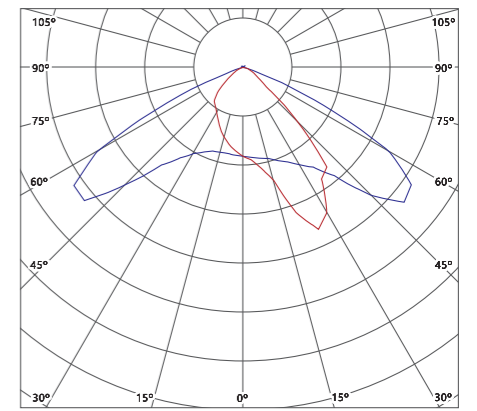

Front View

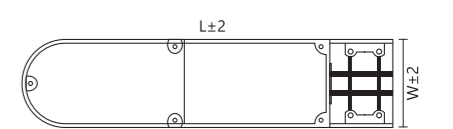

Side View



PRODUCT SPECIFICATIONS

Housing

Pressure die-cast aluminium alloy for housing (heat sink) for effective thermal management, sturdiness & excellent corrosion-resistance. Cable gland is used for maintaining ingress protection. Epoxy powder coated with smooth finish. High-quality PC cover fixed to the housing.

Optics

High lumen efficacy LED module with SMD LED package mounted with PC lens to ensure better uniformity of light distribution.

Mounting

Suitable for pole mounting with bracket arm.

Control Gear

Powered by an integral electronic driver with output short-Circuit Protection, Surge Protection & other safety tests.

Surge Protection

Up to 4 KV (internal); optional 10 KV external SPD

IP

66

RECOMMENDED USAGE

• Road Lighting • Campus Lighting • Industrial Estates • Open Parking • Circulating Areas

TECHNICAL DETAILS

Model No.	System Wattage	Rated CCT	CRI	Rated Voltage	Power Factor	Dimensions (in mm)				
						L	W	H	D	
LSFS-020-CF	20W	5700K	≥70	240V AC	≥0.95	3225	79	79	54	540

CCT's are available in Cool white, Neutral white & Warm white.

FIESTA PC

LED streetlight designed with excellent thermally managed aluminium pressure die-cast housing having heat-dissipating fins for larger surface area, matte-finish powder-coated in grey paint and fitted with polycarbonate cover in the front for the desired Ingress Protection.

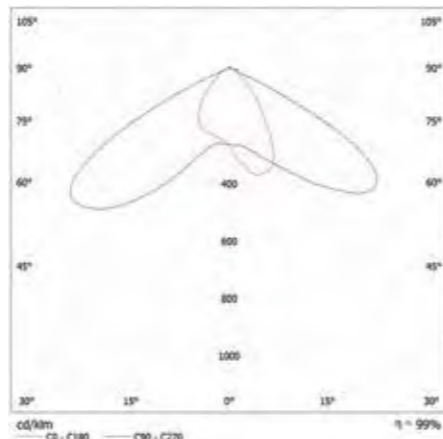

Front View

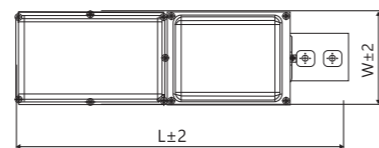

Side View

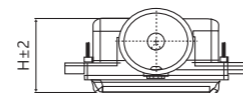

PRODUCT SPECIFICATIONS

Housing

Pressure die-cast aluminium alloy for housing (heat sink) for effective thermal management, sturdiness & excellent corrosion-resistance. Cable gland is used for maintaining ingress protection. Epoxy powder-coated with smooth finish. High-quality PC cover fixed to the housing.

Optics

High lumen efficacy LED module with SMD LED package mounted with PC lens to ensure better uniformity of light distribution.

Mounting

Suitable for pole mounting with bracket arm.

Control Gear

Powered by an integral electronic driver with output Short-Circuit Protection, Surge Protection & other safety tests.

Surge Protection

Up to 4 KV (Internal); optional 10 KV external SPD

IP

66

RECOMMENDED USAGE

• Road Lighting • Campus Lighting • Industrial Estates • Open Parking • Circulating Areas

TECHNICAL DETAILS

Model No.	System Wattage	Rated CCT	CRI	Rated Voltage	Power Factor	Dimensions (in mm)		
						L	W	H
LSFS-25-CF-PC	25W	5700K	≥70	240V AC	≥0.95	246	103	85
LSFS-36-CF-PC	36W	5700K	≥70	240V AC	≥0.95	255	118	85
LSFS-45-CF-PC	45W	5700K	≥70	240V AC	≥0.95	255	118	85

CCT's are available in Cool white, Neutral white & Warm white.

FIESTA PLUS

Highly-efficient LED streetlight with aluminium pressure die-cast housing toughened glass in the front and peanut lens for batwing light distribution to ensure uniform light distribution. Front maintainable driver compartment for easy maintenance.

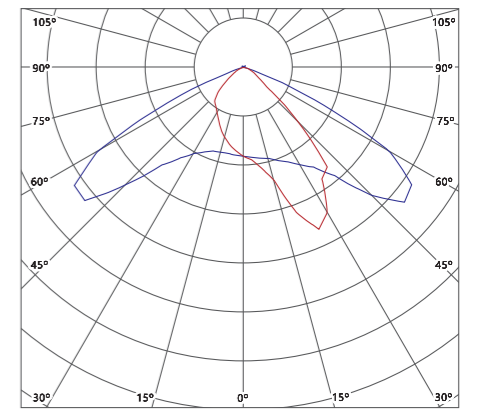

Front View

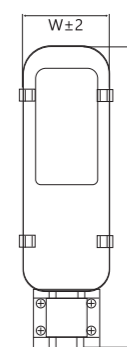

Side View

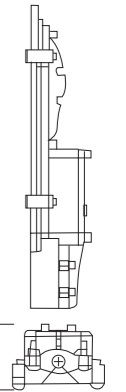

PRODUCT SPECIFICATIONS

Housing

Pressure die-cast aluminium alloy for housing (heat sink) for effective thermal management, sturdiness & excellent corrosion resistance. Cable gland is used for maintaining ingress protection. Epoxy powder-coated with smooth finish. Tempered protective toughened glass, thermal, shock and impact-resistant, fixed to the housing.

Optics

High lumen efficacy LED module with SMD LED package mounted with PC lens to ensure better uniformity of light distribution.

Mounting

Suitable for pole mounting with bracket arm.

Control Gear

Powered by an integral electronic driver with output short-Circuit Protection, Surge Protection & other safety tests.

Surge Protection

Up to 4 KV (internal); optional 10 KV external SPD

IP

66

RECOMMENDED USAGE

• Road Lighting • Campus Lighting • Industrial Estates • Open Parking • Circulating Areas

TECHNICAL DETAILS

Model No.	System Wattage	Rated CCT	CRI	Rated Voltage	Power Factor	Dimensions (in mm)			
						L	W	H	Pole OD
LSFS-020-C	20W	5700K	≥70	240V AC	≥0.95	325	94	74	25-35
LSFS-030-C	30W	5700K	≥70	240V AC	≥0.95	325	94	74	25-35

CCT's are available in Cool white, Neutral white & Warm white.

FIESTA PLUS

Highly-efficient LED streetlight with aluminium pressure die-cast housing toughened glass in the front, and peanut lens for batwing light distribution to ensure uniform light distribution. Top maintainable driver compartment for easy maintenance.

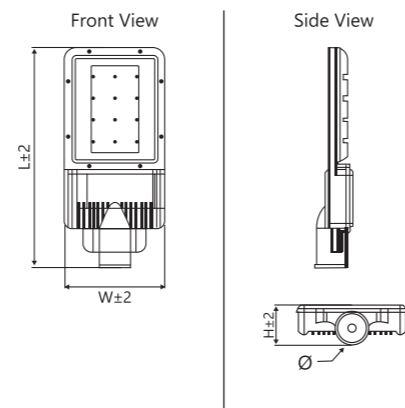
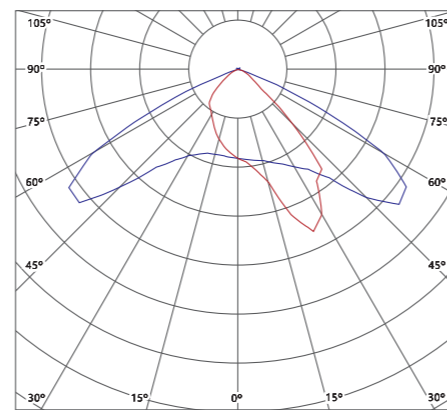

PRODUCT SPECIFICATIONS

Housing

Pressure die-cast aluminium housing (heat sink) and elegantly designed extruded aluminium heat sink for effective thermal management, sturdiness & excellent corrosion-resistance. Cable gland is used for maintaining ingress protection. Epoxy powder-coated with smooth finish. Tempered protective toughened glass, thermal, shock and impact-resistant, fixed to the housing.

Optics

High lumen efficacy LED module with SMD LED package mounted with PC lens to ensure better uniformity of light distribution.

Mounting

Suitable for pole mounting with bracket arm.

Control Gear

Powered by an integral electronic driver with output Short-Circuit Protection, Surge Protection & other safety tests.

Surge Protection

Up to 4 kV (internal); Inbuilt 10 kV external SPD

IP

66

RECOMMENDED USAGE

• Road Lighting • Campus Lighting • Industrial Estates • Open Parking • Circulating Areas

TECHNICAL DETAILS

Model No.	System Wattage	Rated CCT	CRI	Rated Voltage	Power Factor	Dimensions (in mm)		
						L	W	H
LSFS-040-C	40W	5700K	≥70	240V AC	≥0.95	325	94	74
LSFS-045-C	45W	5700K	≥70	240V AC	≥0.95	325	94	74
LSFS-060-C	60W	5700K	≥70	240V AC	≥0.95	388	95	88
LSFS-070-C	70W	5700K	≥70	240V AC	≥0.95	391	179	62
LSFS-080-C	80W	5700K	≥70	240V AC	≥0.95	391	179	62
LSFS-090-C	90W	5700K	≥70	240V AC	≥0.95	391	179	62
LSFS-110-C	110W	5700K	≥70	240V AC	≥0.95	446	226	115
LSFS-120-C	120W	5700K	≥70	240V AC	≥0.95	446	226	115
LSFS-150-C	150W	5700K	≥70	240V AC	≥0.95	446	226	115
LSFS-160-C	160W	5700K	≥70	240V AC	≥0.95	540	266	90
LSFS-180-C	180W	5700K	≥70	240V AC	≥0.95	540	266	90
LSFS-200-C	200W	5700K	≥70	240V AC	≥0.95	540	266	90
LSFS-250-C	250W	5700K	≥70	240V AC	≥0.95	660	264	97

CCT's are available in Cool white, Neutral white & Warm white.

FIESTA PLUS PC

Highly-efficient LED streetlight with aluminium pressure die-cast housing and engraved PC lens in the front for batwing light distribution to ensure uniform light distribution. Front maintainable driver compartment for easy maintenance.

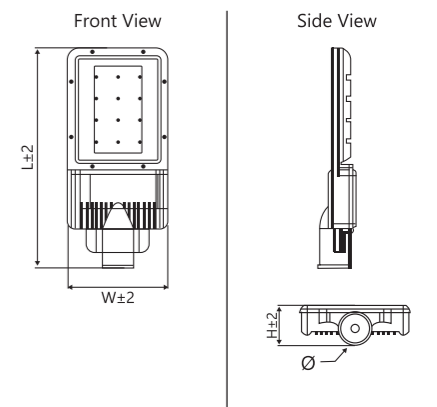
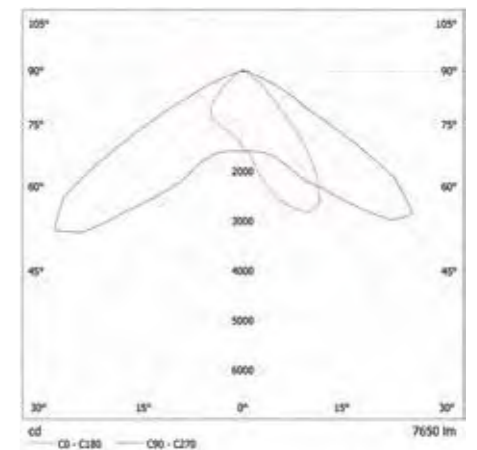

PRODUCT SPECIFICATIONS

Housing

Pressure die-cast aluminium for housing for effective thermal management, sturdiness & excellent corrosion resistance. Cable gland is used for maintaining ingress protection. Epoxy powder-coated with smooth finish. Engraved PC lens front cover fixed to the housing.

Optics

High lumen efficacy LED module with SMD LED package mounted with engraved PC lens to ensure better uniformity of light distribution.

Mounting

Suitable for pole mounting with bracket arm.

Control Gear

Powered by an integral electronic driver with output short-Circuit Protection, Surge Protection & other safety tests.

Surge Protection

Up to 4 kV (internal); optional 10 kV external SPD

IP

66

RECOMMENDED USAGE

• Road Lighting • Campus Lighting • Industrial Estates • Open Parking • Circulating Areas

TECHNICAL DETAILS

Model No.	System Wattage	Rated CCT	CRI	Rated Voltage	Power Factor	Dimensions (in mm)		
						L	W	H
LSFS-030-C-PC	30W	5700K	≥70	240V AC	≥0.95	253	85	70
LSFS-045-C-PC	45W	5700K	≥70	240V AC	≥0.95	317	96	57
LSFS-060-C-PC	60W	5700K	≥70	240V AC	≥0.95	300	153	89
LSFS-070-C-PC	70W	5700K	≥70	240V AC	≥0.95	300	153	89
LSFS-090-C-PC	90W	5700K	≥70	240V AC	≥0.95	300	153	89
LSFS-100-C-PC	100W	5700K	≥70	240V AC	≥0.95	300	153	89
LSFS-120-C-PC	120W	5700K	≥70	240V AC	≥0.95	366	196	90
LSFS-150-C-PC	150W	5700K	≥70	240V AC	≥0.95	480	210	93
LSFS-180-C-PC	180W	5700K	≥70	240V AC	≥0.95	539	263	90
LSFS-200-C-PC	200W	5700K	≥70	240V AC	≥0.95	539	263	90

CCT's are available in Cool white, Neutral white & Warm white.

SIGMA

Energy saving, robust LED Flood light luminaires with high efficacy suitable for highlighting architectural facade highmast and general purpose lighting.

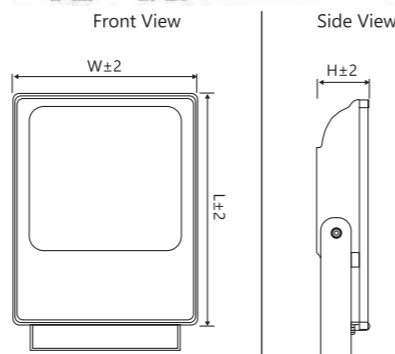
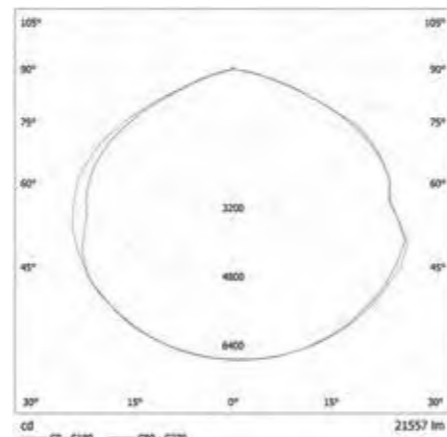

PRODUCT SPECIFICATIONS

Housing

Aluminum alloy pressure die casted housing & control gear box for better heat dissipation and aesthetic appeal. The fixture is epoxy powder coated with smooth finish.

Optics

High lumen efficacy LED module with SMD LED package mounted to ensure better uniformity of light distribution.

Mounting

Wall or surface mounting using adjustable MS cradle.

Control Gear

Powered by an integral electronic driver with output short-circuit protection, surge protection & other safety tests.

Surge Protection

Upto 4 KV (Internal)

IP

65

RECOMMENDED USAGE

- Area Lighting • Building Façade • Open Parking • Security Lighting
- Construction Sites Lighting

TECHNICAL DETAILS

Model No.	System Wattage	Rated CCT	CRI	Rated Voltage	Power Factor	Dimensions (in mm)		
						L	W	H
LFSM-020-C-V1	20W	5700K	≥70	240V AC	≥0.95	179	184	44
LFSM-030-C-V1	30W	5700K	≥70	240V AC	≥0.95	179	184	44
LFSM-040-C-V1	40W	5700K	≥70	240V AC	≥0.95	224	229	52
LFSM-050-C-V1	50W	5700K	≥70	240V AC	≥0.95	224	229	52
LFSM-060-C-V1	60W	5700K	≥70	240V AC	≥0.95	224	229	52
LFSM-070-C-V1	70W	5700K	≥70	240V AC	≥0.95	275	285	63
LFSM-080-C-V1	80W	5700K	≥70	240V AC	≥0.95	275	285	63
LFSM-100-C-V1	100W	5700K	≥70	240V AC	≥0.95	275	285	63
LFSM-120-C-V1	120W	5700K	≥70	240V AC	≥0.95	306	285	75
LFSM-150-C-V1	150W	5700K	≥70	240V AC	≥0.95	306	285	75
LFSM-160-C-V1	160W	5700K	≥70	240V AC	≥0.95	306	285	75
LFSM-180-C-V1	180W	5700K	≥70	240V AC	≥0.95	355	327	75
LFSM-200-C-V1	200W	5700K	≥70	240V AC	≥0.95	355	327	84
LFSM-250-C-V1	250W	5700K	≥70	240V AC	≥0.95	355	327	84
LFSM-300-C-V1	300W	5700K	≥70	240V AC	≥0.95	400	420	75
LFSM-350-C-V1	350W	5700K	≥70	240V AC	≥0.95	510	395	155
LFSM-400-C-V1	400W	5700K	≥70	240V AC	≥0.95	510	395	155

CCT's are available in Cool white, Neutral white & Warm white. 350W & 400W driver on back of the luminaire part.

SIGMA ULTRA

Energy-saving, robust LED flood light luminaires with high efficacy-suitable for highlighting architectural facade High-mast and general purpose lighting.

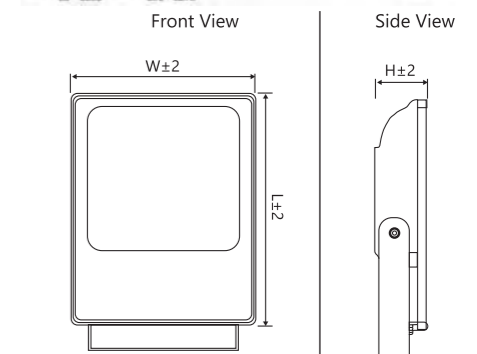
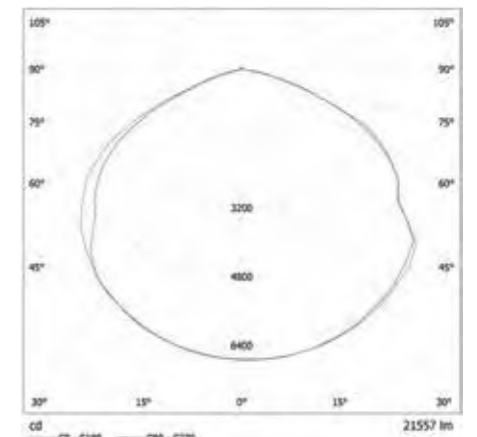

PRODUCT SPECIFICATIONS

Housing

Aluminium alloy pressure die-casted housing & control gear box for better heat dissipation and aesthetic appeal. The fixture is epoxy powder-coated with smooth finish.

Optics

High lumen efficacy LED module with SMD LED package mounted

Mounting

Wall or surface mounting using adjustable MS cradle.

Control Gear

Powered by an integral electronic driver with output Short-Circuit Protection, Surge Protection & other safety tests.

Surge Protection

Up to 4 KV (internal); Inbuilt 10 KV external SPD

IP

66

RECOMMENDED USAGE

- Area Lighting • Building Façade • Open Parking • Security Lighting

TECHNICAL DETAILS

Model No.	System Wattage	Rated CCT	CRI	Rated Voltage	Power Factor	Dimensions (in mm)		
						L	W	H
LFSMU-070-C	70W	5700K	≥70	240V AC	≥0.95	228	188	130
LFSMU-100-C	100W	5700K	≥70	240V AC	≥0.95	305	305	80
LFSMU-120-C	120W	5700K	≥70	240V AC	≥0.95	305	305	80
LFSMU-150-C	150W	5700K	≥70	240V AC	≥0.95	305	305	80
LFSMU-200-C	200W	5700K	≥70	240V AC	≥0.95	390	299	155
LFSMU-250-C	250W	5700K	≥70	240V AC	≥0.95	390	299	155

CCT's are available in Cool white, Neutral white & Warm white.

SIGMA PLUS

Energy-saving, robust LED flood light luminaires with high- efficacy suitable for stadium and sports lighting. High-mast and general purpose lighting.

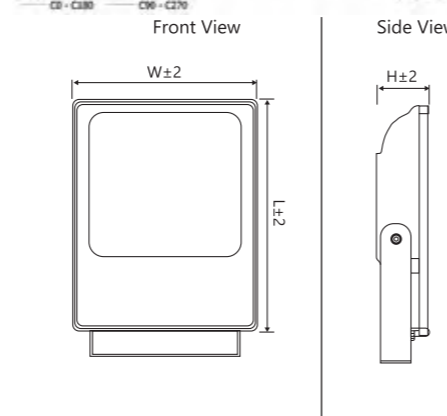
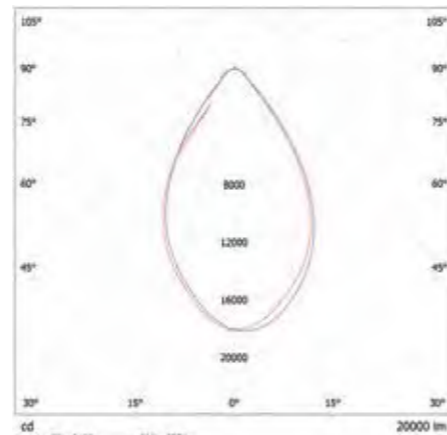

PRODUCT SPECIFICATIONS

Housing

Aluminium alloy pressure die-casted housing & control gear box for better heat dissipation and aesthetic appeal. The fixture is epoxy powder- coated with smooth finish.

Optics

High lumen efficacy LED module with SMD LED package mounted with PC lens to ensure better uniformity of light distribution.

Mounting

Wall or surface mounting using adjustable MS cradle.

Control Gear

Powered by an integral electronic driver with output Short-Circuit Protection, Surge Protection & other safety tests.

Surge Protection

Up to 4 KV (internal); Inbuilt 10 KV external SPD

IP

66

RECOMMENDED USAGE

• Sports & Stadium Lighting • Highmast Lighting • Security Lighting • Junction Lighting

TECHNICAL DETAILS

Model No.	System Wattage	Rated CCT	CRI**	Rated Voltage	Power Factor	Dimensions (in mm)		
						L	W	H
LFSMP-050-C	50W	5700K	≥70	240V AC	≥0.95	247	190	68
LFSMP-080-C	80W	5700K	≥70	240V AC	≥0.95	247	190	68
LFSMP-100-C	100W	5700K	≥70	240V AC	≥0.95	400	258	82
LFSMP-120-C	120W	5700K	≥70	240V AC	≥0.95	400	258	82
LFSMP-150-C	150W	5700K	≥70	240V AC	≥0.95	400	258	82
LFSMP-200-C	200W	5700K	≥70	240V AC	≥0.95	460	304	90
LFSMP-250-C	250W	5700K	≥70	240V AC	≥0.95	460	304	90
LFSMP-300-C	300W	5700K	≥70	240V AC	≥0.95	503	346	75
LFSMP-350-C	350W	5700K	≥70	240V AC	≥0.95	503	346	75
LFSMP-400-C	400W	5700K	≥70	240V AC	≥0.95	503	346	75

ALPHA

Energy-saving, robust LED flood light luminaires with high efficacy-suitable for highlighting architectural facade High-mast and general purpose lighting.

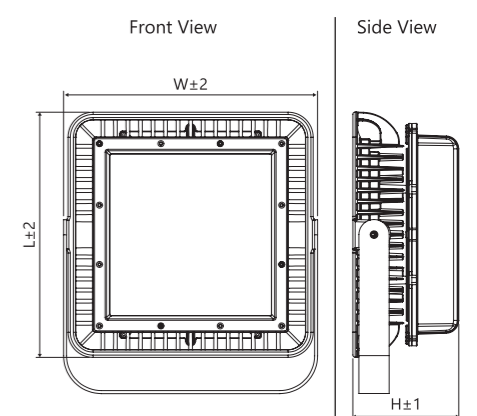
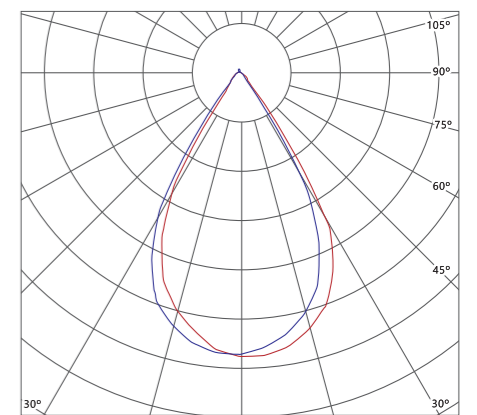

PRODUCT SPECIFICATIONS

Housing

Aluminium alloy pressure die-casted housing & control gear box for better heat dissipation and aesthetic appeal. Gland is used for cable entry and loopin-loopout. The fixture is epoxy powder- coated with smooth finish.

Optics

High lumen efficacy LED module with SMD LED package mounted with PC lens to ensure better uniformity of light distribution.

Mounting

Wall or surface mounting using adjustable MS cradle.

Control Gear

Powered by an integral electronic driver with output Short-Circuit Protection, Surge Protection & other safety tests.

Surge Protection

Up to 4 KV (internal); Inbuilt 10 KV external SPD

IP

66

RECOMMENDED USAGE

• Area Lighting • Building Façade • Open Parking • Security Lighting • Junction Lighting

TECHNICAL DETAILS

Model No.	System Wattage	Rated CCT	CRI	Rated Voltage	Power Factor	Dimensions (in mm)		
						L	W	H
LFAP-050-C	50W	5700K	≥70	240V AC	≥0.95	237	238	125
LFAP-060-C	60W	5700K	≥70	240V AC	≥0.95	237	238	125
LFAP-070-C	70W	5700K	≥70	240V AC	≥0.95	237	238	125
LFAP-080-C	80W	5700K	≥70	240V AC	≥0.95	237	238	125
LFAP-100-C	100W	5700K	≥70	240V AC	≥0.95	237	238	125
LFAP-120-C	120W	5700K	≥70	240V AC	≥0.95	324	328	139
LFAP-150-C	150W	5700K	≥70	240V AC	≥0.95	324	328	139
LFAP-200-C	200W	5700K	≥70	240V AC	≥0.95	324	328	139
LFAP-250-C	250W	5700K	≥70	240V AC	≥0.95	324	328	139

CCT's are available in Cool white, Neutral white & Warm white.

DELTA

Energy-saving, robust LED flood light luminaires with high- efficacy suitable for stadium and sports lighting. High-mast and general purpose lighting.

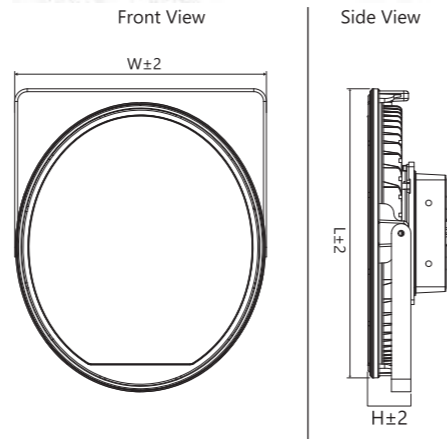
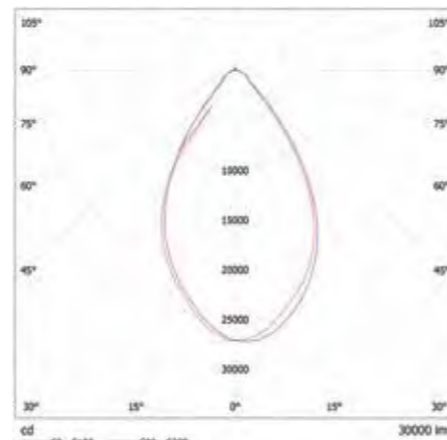

PRODUCT SPECIFICATIONS

Housing

Aluminium alloy pressure die-casted housing & control gear box for better heat dissipation and aesthetic appeal. The fixture is epoxy powder-coated with smooth finish.

Optics

High lumen efficacy LED module with SMD LED package mounted with PC lens to ensure better uniformity of light distribution.

Mounting

Wall or surface mounting using adjustable MS cradle.

Control Gear

Powered by an integral electronic driver with output Short-Circuit Protection, Surge Protection & other safety tests.

Surge Protection

Up to 4 KV (internal); Inbuilt 10 KV external SPD

IP

66

RECOMMENDED USAGE

• Sports & Stadium Lighting • Highmast Lighting • Security Lighting • Junction Lighting

TECHNICAL DETAILS

Model No.	System Wattage	Rated CCT	CRI**	Rated Voltage	Power Factor	Dimensions (in mm)		
						L	W	H
LFDT-300-C	300W	5700K	≥70	240V AC	≥0.95	379	325	166
LFDT-350-C	350W	5700K	≥70	240V AC	≥0.95	460	394	177
LFDT-400-C	400W	5700K	≥70	240V AC	≥0.95	460	394	177
*LFDT-450-C	450W	5700K	≥70	240V AC	≥0.95	500	419	177
*LFDT-500-C	500W	5700K	≥70	240V AC	≥0.95	500	419	177

*Separate Driver box is provided in 450W & 500W.

**Customised CRI can be provided on request.

CCT's are available in Cool white, Neutral white & Warm white.





SOLAR LIGHTING

SOLARIN

Highly efficient IP65 LED Solar Lighting System with built-in high efficiency Solar Panel, LED Light and long-life LiFePO4 / Li-ion battery with high efficiency microprocessor-based charge controller and PIR sensor. The light has automatic dusk to down operation and maintenance free after installation.

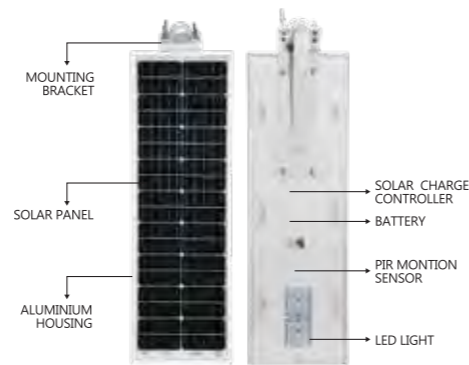

PRODUCT SPECIFICATIONS

Housing

Elegantly designed aluminum housing and heat sink for efficient thermal management, sturdiness and excellent corrosion resistance.

Optics

135° x 85° PC Lens.

Mounting

Pole Mounting.

Panel

Solar Photovoltaic Panel.

Battery Type

Lithium

IP

65

RECOMMENDED USAGE

• Parks and Garden Lighting • Pathway Lighting • Street Lanterns

TECHNICAL DETAILS

Model No.	Wattage (W)	Solar Panel (W)	Battery Capacity (AH)	Autonomy	CRI	Beam Angle
LSSN-09C30-12P	9	30	12	24 Hours	≥70	135°/85°
LSSN-12C40-18P	12	40	18	24 Hours	≥70	135°/85°
LSSN-15C40-24P	15	40	24	24 Hours	≥70	135°/85°
LSSN-20C50-30P	20	50	30	24 Hours	≥70	135°/85°
LSSN-30C90-30P	30	90	30	24 Hours	≥70	135°/85°
LSSN-40C70-30P	40	70	30	12 Hours	≥70	135°/85°

SOLAR SPIKE LIGHT

IP65 LED solar garden spike light with solar panel, 4 No. LED Light and Lithium battery with charge controller.



PRODUCT SPECIFICATIONS

Housing

Elegantly designed aluminum housing and heat sink for efficient thermal management, sturdiness and excellent corrosion resistance.

Optics

Clear diffuser.

Mounting

Spike mounted.

Panel

Solar Photovoltaic Panel.

Battery Type

Lithium

IP

65

RECOMMENDED USAGE

• Planter Area Lighting • Ornamental Lighting

TECHNICAL DETAILS

Model No.	Wattage (W)	Solar Panel (W)	Battery Capacity (AH)	Autonomy	CRI	Beam Angle
LSSL-04-C	1W x 4 Nos	5.5	6	8 Hours	≥70	≥120°

SOLAR BOLLARD

IP65 LED Solar bollard with built-in solar panel, LED Light and Lithium battery with charge controller.



PRODUCT SPECIFICATIONS

Housing

Elegantly designed aluminum housing and heat sink for efficient thermal management, sturdiness and excellent corrosion resistance.

Optics

Opal diffuser.

Mounting

Fixed on ground.

Panel

Solar Photovoltaic Panel.

Battery Type

Lithium

IP

65

RECOMMENDED USAGE

• Parks and Garden Lighting • Pathway Lighting

TECHNICAL DETAILS

Model No.	Wattage (W)	Solar Panel (W)	Battery Capacity (AH)	Autonomy	CRI	Beam Angle
LSBL-03-C	3	3.5	4	8 Hours	≥70	≥120°



SOLAR GATE LIGHT

IP65 LED Solar surface post top with built-in Solar panel, LED light and Lithium battery with charge controller.



PRODUCT SPECIFICATIONS

Housing

Elegantly designed aluminum housing and heat sink for efficient thermal management, sturdiness and excellent corrosion resistance.

Optics

Clear diffuser.

Mounting

Surface mounting.

Panel

Solar photovoltaic panel.

Battery Type

Lithium.

IP

65

RECOMMENDED USAGE

Parks and Garden Lighting • Gate Lighting • Boundary Lighting

TECHNICAL DETAILS

Model No.	Wattage (W)	Solar Panel (W)	Battery Capacity (AH)	Autonomy	CRI	Beam Angle
LSGL-02-C	2	3.7	2.5	8 Hours	≥70	≥120°

SOLAR PILLAR LIGHT

IP65 LED Solar pillar light with built-in Solar panel, LED Light and Lithium battery with charge controller.



PRODUCT SPECIFICATIONS

Housing

Elegantly designed aluminum housing and heat sink for efficient thermal management, sturdiness and excellent corrosion resistance.

Optics

Opal diffuser.

Mounting

Pole mounted.

Panel

Solar photovoltaic panel.

Battery Type

Lithium

IP

65

RECOMMENDED USAGE

Parks and Garden Lighting • Gate Lighting • Boundary Lighting

TECHNICAL DETAILS

Model No.	Wattage (W)	Solar Panel (W)	Battery Capacity (AH)	Autonomy	CRI	Beam Angle
LSPL-03-C	3	5	4.4	8 Hours	≥70	≥120°

SOLAR POST TOP

IP65 LED Solar post top with built-in Solar panel, LED light and Lithium battery with charge controller.

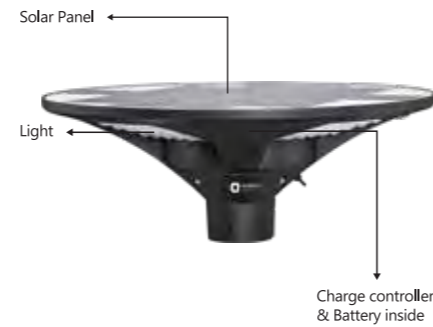

PRODUCT SPECIFICATIONS

Housing

Elegantly designed aluminum housing and heat sink for efficient thermal management, sturdiness and excellent corrosion resistance.

Optics

High lumen efficacy LED module with SMD LED package mounted with PC lens to ensure better uniformity of light distribution.

Mounting

Pole mounting.

Panel

Solar photovoltaic panel.

Battery Type

Lithium

IP

65

RECOMMENDED USAGE

Parks and Garden Lighting • Pathway Lighting

TECHNICAL DETAILS

Model No.	Wattage (W)	Solar Panel (W)	Battery Capacity (AH)	Autonomy	CRI	Beam Angle
LSPT-25-C	25	25	24	8 Hours	≥70	≥120°





LANDSCAPE LIGHTING

SPIKE LIGHT

Energy-saving, stylish LED spike light luminaires with high-efficacy; suitable for highlighting architectural & ornamental planter area lighting.

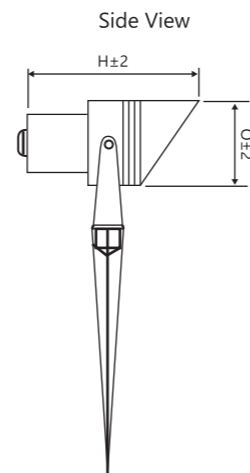
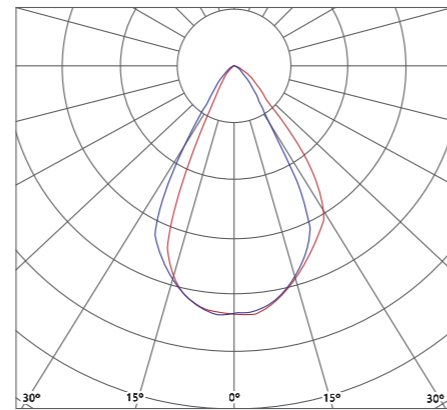

PRODUCT SPECIFICATIONS

Housing

Aluminium alloy pressure die-casted housing for better heat dissipation and aesthetic appeal. The fixture is epoxy powder-coated with smooth finish.

Optics

Clear diffuser is used for effective distribution of light

Mounting

In-ground, spike-mounted.

Control Gear

Powered by an integral electronic driver with output Short-Circuit Protection, Surge Protection & other safety tests.

Surge Protection

Up to 2 KV (internal)

IP

65

RECOMMENDED USAGE

• Parks and Gardens • Residential Areas • Squares and Plazas

TECHNICAL DETAILS

Model No.	System Wattage	Rated CCT	CRI	Rated Voltage	Power Factor	Dimensions (in mm)	
						Ø	H*
LLSL-03-W	3W	3000K	≥70	240V AC	-	72	85
LLSL-06-W	6W	3000K	≥70	240V AC	-	72	85
LLSL-09-W	9W	3000K	≥70	240V AC	-	80	105
LLSL-12-W	12W	3000K	≥70	240V AC	-	75	150

*H mentioned without spike.
CCT's are available in Cool white, Neutral white & Warm white.

STEP LIGHT

Energy-saving, long-life, aesthetically designed decorative rectangular-shaped wall-recessed luminaires for step lighting.

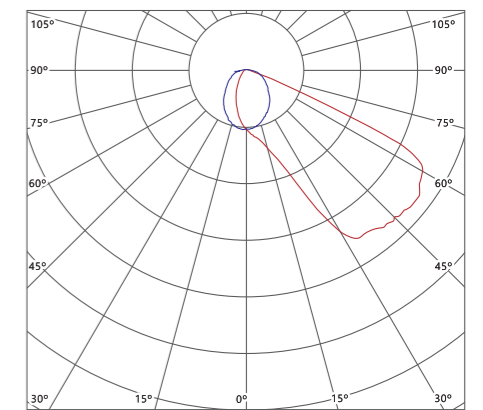

Front View



Side View

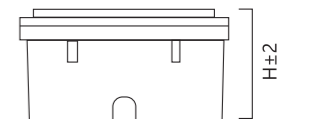

PRODUCT SPECIFICATIONS

Housing

Pressure die-cast aluminium housing for sturdiness, excellent corrosion resistance and efficient thermal management.

Optics

White-finish front cover is designed to provide glare-free downward lighting. High lumen efficacy LED module ensure precise light distribution.

Mounting

Recessed in wall.

Control Gear

Powered by an integral electronic driver with output Short-Circuit Protection, Surge Protection & other safety tests.

Surge Protection

Up to 2 KV (internal)

IP

54

RECOMMENDED USAGE

• Supermarket & Malls Staircases • Stairways & Walkways • Outdoor Staircases
• Wall Lights

TECHNICAL DETAILS

Model No.	System Wattage	Rated CCT	CRI	Rated Voltage	Power Factor	Dimensions (in mm)		
						L	W	H
LLSP-03-W	3W	3000K	≥70	240V AC	-	80	80	42
LLSP-06-W	6W	3000K	≥70	240V AC	-	175	85	42

CCT's are available in Cool white, Neutral white & Warm white.

GROUND BURIAL

Energy-saving, long-life, ground burial light is a floor-embedded luminaire suitable for architectural lighting of outdoor landscapes.

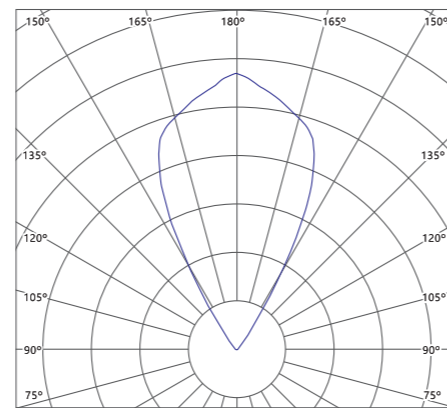

Front View

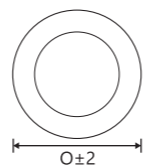

Side View

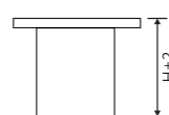

PRODUCT SPECIFICATIONS

Housing

Aluminium die-casting with anodised finish and epoxy powder-coating.

Mounting

Fixed to ground.

Optics

Tempered glass acts as cover.

Control Gear

Powered by an integral electronic driver with output Short-Circuit Protection, Surge Protection & other safety tests.

Surge Protection

Up to 2 KV (Internal)

IP

67

RECOMMENDED USAGE

• Hotels • Shop • Restaurants • Shopping Malls • Showrooms • Outdoor Landscapes

TECHNICAL DETAILS

Model No.	System Wattage	Rated CCT	CRI	Rated Voltage	Power Factor	Dimensions (in mm)	
						O	H
LLGB-15-W	15W	3000K	≥70	240V AC	≥0.9	150	94

CCT's are available in Cool white, Neutral white & Warm white.

CRYSTAL BOLLARD

LED bollard light IP65 having a cylindrical body placed on top. Ideal for architectural outdoor lighting, typically giving off light from the sides, suitable to illuminate walkways, steps or pathways.

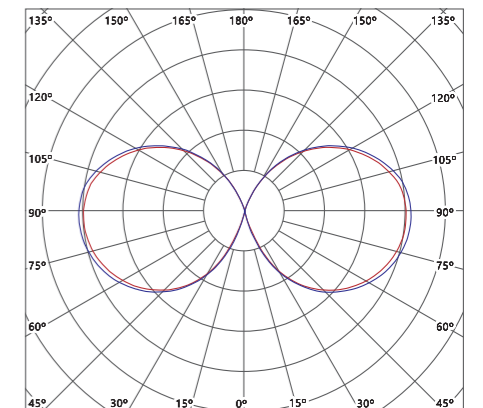

Front View

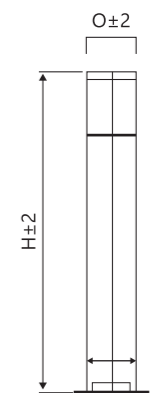

PRODUCT SPECIFICATIONS

Housing

Housing made up of aluminium pipe powder-coated black after phosphochromate treatment with aluminium heat sink for effective thermal management, sturdiness & excellent corrosion resistance.

Optics

Opal diffuser is used for glare-free uniform light distribution. High efficiency and long-life LEDs with high lumen efficacies are used.

Mounting

Fixed to ground.

Control Gear

Powered by an integral electronic driver with output Short-Circuit Protection, Surge Protection & other safety tests.

Surge Protection

Up to 2 KV (internal)

IP

65

RECOMMENDED USAGE

• Parks and Gardens • Townships • Squares and Plazas

TECHNICAL DETAILS

Model No.	System Wattage	Rated CCT	CRI	Rated Voltage	Power Factor	Dimensions (in mm)	
						O	H
LLCBL-10-W	10W	3000K	≥70	240V AC	≥0.9	75	600
LLCBL-10-W-B	10W	3000K	≥70	240V AC	≥0.9	75	800

CCT's are available in Cool white, Neutral white & Warm white.

STEP BOLLARD

Energy-saving, long-life, aesthetically designed aluminium landscape luminaires for diffused lighting with high-power LED as light source.

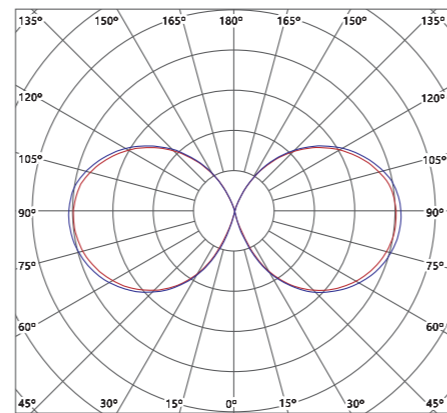

Front View

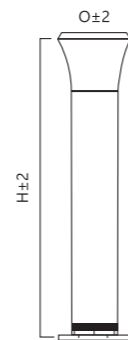

PRODUCT SPECIFICATIONS

Housing

Housing made up of aluminium pipe powder-coated black after phosphochromate treatment with aluminium heat sink for effective thermal management, sturdiness & excellent corrosion resistance.

Optics

Opal diffuser is used for glare-free uniform light distribution. High efficiency and long-life LEDs with high lumen efficacies are used.

Mounting

Fixed to Ground.

Accessories

Powered by an integral electronic driver with output Short-Circuit Protection, Surge Protection & other safety tests.

Surge Protection

Up to 2 KV (internal)

IP

65

RECOMMENDED USAGE

• Parks and gardens • Townships • Squares and Plazas

TECHNICAL DETAILS

Model No.	System Wattage	Rated CCT	CRI	Rated Voltage	Power Factor	Dimensions (in mm)	
						O	H
LLSBL-10-W	10W	3000K	≥70	240V AC	≥0.9	100	610
LLSBL-10-W-B	10W	3000K	≥70	240V AC	≥0.9	100	800

CCT's are available in Cool white, Neutral white & Warm white.

OYSTER BOLLARD

LED bollard light IP65 aesthetically designed landscape luminaire for diffused lighting. Suitable for architectural outdoor lighting typically giving off light from all sides. Best suitable to illuminate walkways, steps or pathways.

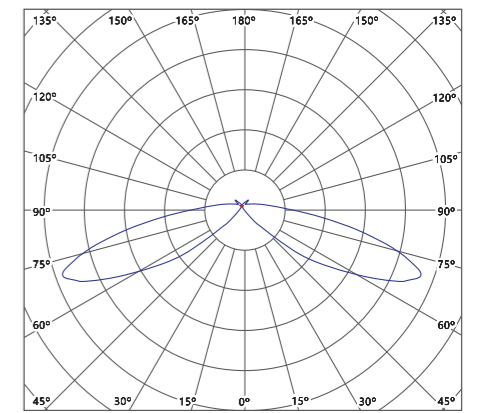

Front View

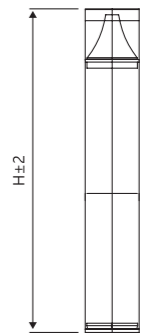

PRODUCT SPECIFICATIONS

Housing

Elegantly designed spun aluminum housing and heat sink for efficient thermal management, sturdiness and excellent corrosion resistance. Two nos. aluminum arms are provided to support the housing. Powder coated black after phosphochromate treatment.

Optics

Opal diffuser is used for glare-free uniform light distribution. High efficiency and long-life LEDs with high lumen efficacies are used.

Mounting

Fixed to ground.

Control Gear

Powered by an integral electronic driver with output short-circuit protection, surge protection & other safety tests.

Surge Protection

Upto 2 KV (Internal)

IP

65

RECOMMENDED USAGE

• Parks and Garden Lighting • Pathway Lighting • Street Lanterns

TECHNICAL DETAILS

Model No.	System Wattage	Rated CCT	CRI	Rated Voltage	Power Factor	Dimensions (in mm)	
						O	H
LLOBL-10-W	10W	3000K	≥70	240V AC	≥0.9	100	600
LLOBL-10-W-B	10W	3000K	≥70	240V AC	≥0.9	100	800

CCT's are available in Cool white, Neutral white & Warm white.

GEM BOLLARD

LED bollard light IP65 having a cylindrical body with LED under PC Lens placed on top. Ideal for architectural outdoor lighting suitable to illuminate walkways, steps or pathways.

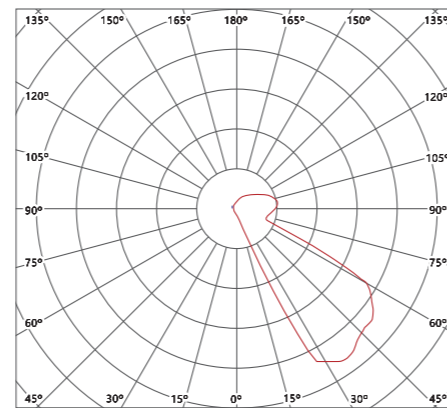

Front View

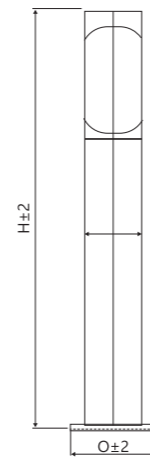

PRODUCT SPECIFICATIONS

Housing

Elegantly designed aluminum housing and heat sink for efficient thermal management, sturdiness and excellent corrosion resistance. MS base plate are provided to support the housing. Powder coated black after phosphochromate treatment.

Optics

High lumen efficacy LED module with SMD LED package mounted with PC lens to ensure better uniformity of light distribution.

Mounting

Ground Mounting.

Control Gear

Powered by an integral electronic driver with output short-circuit protection, surge protection & other safety tests.

Surge Protection

Upto 2 KV (Internal)

IP

65

RECOMMENDED USAGE

• Parks and Garden Lighting • Pathway Lighting • Street Lanterns

TECHNICAL DETAILS

Model No.	System Wattage	Rated CCT	CRI	Rated Voltage	Power Factor	Dimensions (in mm)	
						O	H
LLGBL-10-C	10W	5700K	≥70	240V AC	≥0.9	90	600
LLGBL-10-C-B	10W	5700K	≥70	240V AC	≥0.9	90	800

CCT's are available in Cool white, Neutral white & Warm white.

RING BOLLARD

LED bollard light IP65 having circular profile placed on top. Ideal for architectural outdoor lighting suitable to illuminating Gardens and walkways.

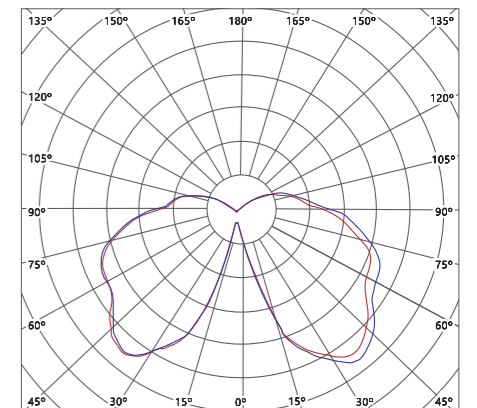

Front View

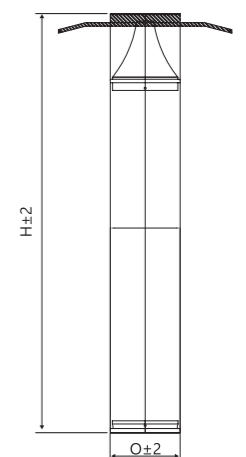

PRODUCT SPECIFICATIONS

Housing

Elegantly designed aluminum housing and heat sink for efficient thermal management, sturdiness and excellent corrosion resistance. MS base plate are provided to support the housing. Powder coated black after phosphochromate treatment.

Optics

Opal diffuser is used for glare-free uniform light distribution. High efficiency and long-life LEDs with high lumen efficacies are used.

Mounting

Ground Mounting.

Control Gear

Powered by an integral electronic driver with output short-circuit protection, surge protection & other safety tests.

Surge Protection

Upto 2 KV (Internal)

IP

65

RECOMMENDED USAGE

• Parks and Garden Lighting • Pathway Lighting • Street Lanterns

TECHNICAL DETAILS

Model No.	System Wattage	Rated CCT	CRI	Rated Voltage	Power Factor	Dimensions (in mm)	
						O	H
LLRBL-15-C	15W	5700K	≥70	240V AC	≥0.9	100	600
LLRBL-15-C-B	15W	5700K	≥70	240V AC	≥0.9	100	800

CCT's are available in Cool white, Neutral white & Warm white.

TOPAZ BOLLARD

LED bollard light IP65 aesthetically designed aluminium housing landscape luminaire for sturdiness with high power LED as light source.

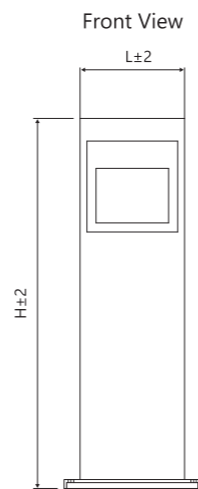
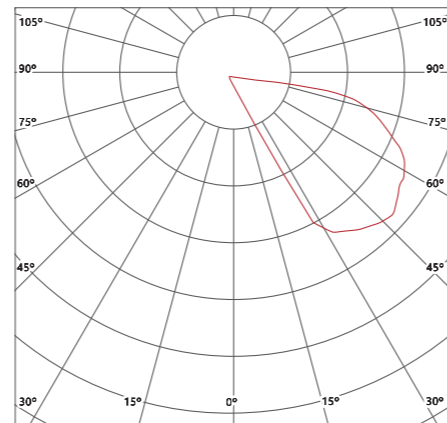

PRODUCT SPECIFICATIONS

Housing

Elegantly designed aluminum (sheet) housing and heat sink for efficient thermal management, sturdiness and excellent corrosion resistance. Die-cast aluminum base provided to support the housing. Powder coated grey after phosphochromate treatment.

Optics

Opal diffuser is used for glare-free uniform light distribution. High efficiency and long-life LEDs with high lumen efficacies are used.

Mounting

Ground Mounting.

Control Gear

Powered by an integral electronic driver with output short-circuit protection, surge protection & other safety tests.

Surge Protection

Upto 2 KV(Internal)

IP

65

RECOMMENDED USAGE

• Parks and Garden Lighting • Pathway Lighting • Street Lanterns

TECHNICAL DETAILS

Model No.	System Wattage	Rated CCT	CRI	Rated Voltage	Power Factor	Dimensions (in mm)	
						LxW	H
LLTBL-20-C	20W	5700K	≥70	240V AC	≥0.9	230x120	815

CCT's are available in Cool white, Neutral white & Warm white.

ASTER

Energy saving, long life aesthetically designed die-cast aluminium landscape luminaire with high power LED as light source.

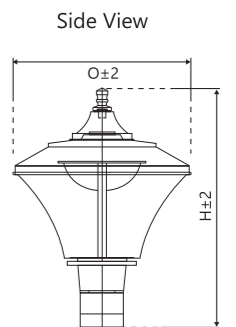
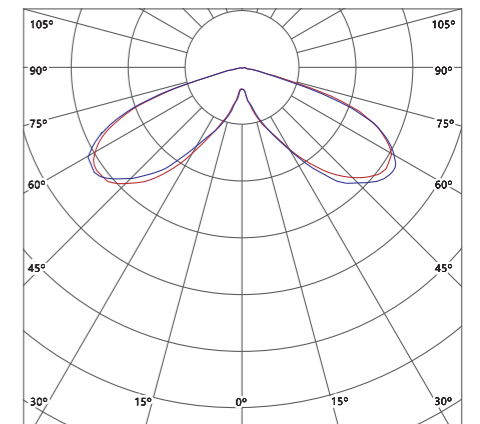

PRODUCT SPECIFICATIONS

Housing

Elegantly designed spun aluminum housing and high grade aluminium heat sink for efficient thermal management, sturdiness and excellent corrosion resistance. MS base provided to support the housing. Powder coated black after phosphochromate treatment.

Optics

Opal diffuser is used for glare-free uniform light distribution. High efficiency and long-life LEDs with high lumen efficacies are used.

Mounting

Pole Mounting.

Control Gear

Powered by an integral electronic driver with output short-circuit protection, surge protection & other safety tests.

Surge Protection

Upto 3.5 KV(Internal);optional 10KV external SPD

IP

65

RECOMMENDED USAGE

• Parks and Garden Lighting • Pathway Lighting • Street Lanterns

TECHNICAL DETAILS

Model No.	System Wattage	Rated CCT	CRI	Rated Voltage	Power Factor	Dimensions (in mm)		
						O	H	Pole OD
LLAS-20-C	20W	5700K	≥70	240V AC	≥0.95	356	500	76
LLAS-30-C	30W	5700K	≥70	240V AC	≥0.95	356	500	76
LLAS-45-C	45W	5700K	≥70	240V AC	≥0.95	356	500	76

CCT's are available in Cool white, Neutral white & Warm white.

OPALINE

LED Post-top IP65 die-cast aluminium spigot for mounting LED driver and spun aluminium canopy which is painted white inside. Epoxy powder-coated matte black finish after phosphochromate treatment.

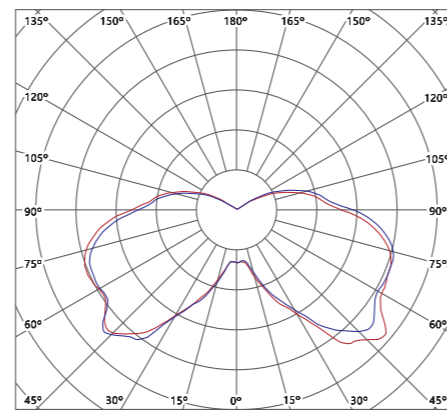

Top View

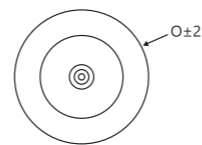

Side View

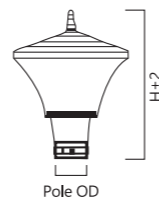

PRODUCT SPECIFICATIONS

Housing

Die-cast aluminium spigot for mounting LED driver and spun aluminium canopy which is painted white inside. Epoxy powder-coated matte black finish after phosphochromate treatment.

Optics

Opal diffuser is used for glare-free uniform light distribution. High efficiency and long-life LEDs with high lumen efficacies are used.

Mounting

Pole-mounting.

Control Gear

Powered by an integral electronic driver with output Short-Circuit Protection, Surge Protection & other safety tests.

Surge Protection

Up to 3.5 KV (internal); optional 10 KV external SPD.

IP

65

RECOMMENDED USAGE

• Parks and Garden Lighting • Pathway Lighting • Street Lanterns

TECHNICAL DETAILS

Model No.	System Wattage	Rated CCT	CRI	Rated Voltage	Power Factor	Dimensions (in mm)		
						Ø	H	Pole OD
LLOP-30-C	30W	5700K	≥70	240V AC	≥0.95	456	528	78

CCT's are available in Cool white, Neutral white & Warm white.

MERIDIAN

Energy saving, long life aesthetically designed die-cast aluminium landscape luminaire with high power LED as light source.

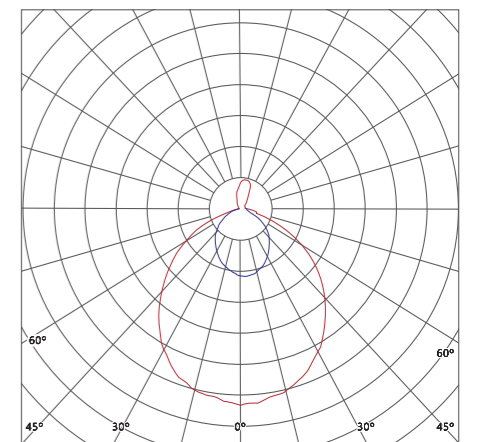

Side View

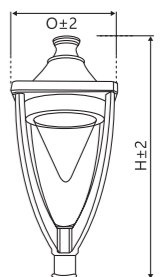

PRODUCT SPECIFICATIONS

Housing

Elegantly designed die-cast aluminum housing and high grade aluminum heat sink for efficient thermal management, sturdiness and excellent corrosion resistance. Four nos. die-cast aluminum arms are provided to support the housing. Powder coated black after phosphochromate treatment.

Optics

Opal diffuser is used for glare-free uniform light distribution. High efficiency and long-life LEDs with high lumen efficacies are used.

Mounting

Pole Mounting.

Control Gear

Powered by an integral electronic driver with output short-circuit protection, surge protection & other safety tests.

Surge Protection

Upto 3.5 KV (Internal); optional 10KV external SPD

IP

65

RECOMMENDED USAGE

• Parks and Garden Lighting • Pathway Lighting • Street Lanterns

TECHNICAL DETAILS

Model No.	System Wattage	Rated CCT	CRI	Rated Voltage	Power Factor	Dimensions (in mm)		
						Ø	H	Pole OD
LLMD-30-C	30W	5700K	≥70	240V AC	≥0.95	315x315	695	78
LLMD-45-C	45W	5700K	≥70	240V AC	≥0.95	315x315	695	78

CCT's are available in Cool white, Neutral white & Warm white.

CRESTINE

Energy saving, long life aesthetically designed die-cast aluminium landscape luminaire with high power LED as light source.

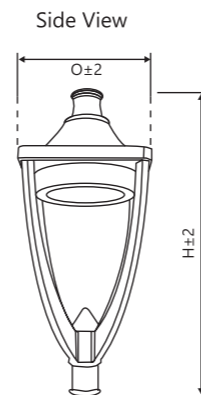
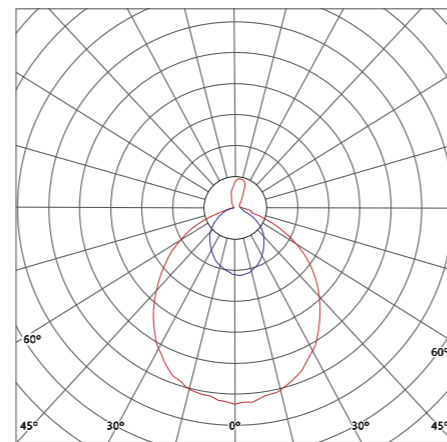

PRODUCT SPECIFICATIONS

Housing

Elegantly designed die-cast aluminum housing and heat sink for efficient thermal management, sturdiness and excellent corrosion resistance. Four nos. die-cast aluminum arms are provided to support the housing. Powder coated black after phosphochromate treatment.

Optics

Clear Cover is used for glare-free uniform light distribution. High efficiency and long-life LEDs with high lumen efficacies are used.

Mounting

Pole Mounting.

Control Gear

Powered by an integral electronic driver with output short-circuit protection, surge protection & other safety tests.

Surge Protection

Upto 3.5 KV(Internal);optional 10KV external SPD

IP

65

RECOMMENDED USAGE

• Parks and Garden Lighting • Pathway Lighting • Street Lanterns

TECHNICAL DETAILS

Model No.	System Wattage	Rated CCT	CRI	Rated Voltage	Power Factor	Dimensions (in mm)		
						O	H	Pole OD
LLCT-45-C	45W	5700K	≥70	240V AC	≥0.95	400x400	922	78
LLCT-60-C	60W	5700K	≥70	240V AC	≥0.95	400x400	922	78

CCT's are available in Cool white, Neutral white & Warm white.

SNOWDROP

Energy saving, long life aesthetically designed die-cast aluminium landscape luminaire with high power LED as light source.

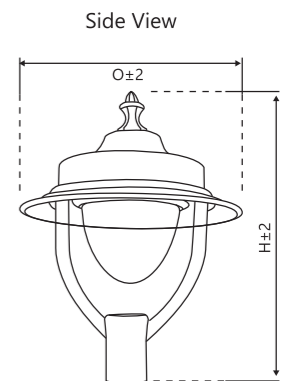
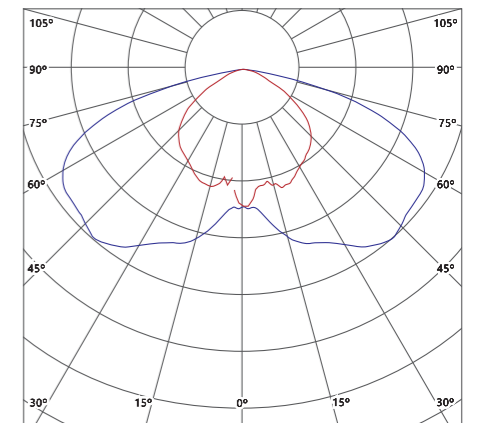

PRODUCT SPECIFICATIONS

Housing

Elegantly designed spun aluminum housing and heat sink for efficient thermal management, sturdiness and excellent corrosion resistance. Two nos. aluminum arms are provided to support the housing. Powder coated black after phosphochromate treatment.

Optics

Opal diffuser is used for glare-free uniform light distribution. High efficiency and long-life LEDs with high lumen efficacies are used.

Mounting

Pole Mounting.

Control Gear

Powered by an integral electronic driver with output short-circuit protection, surge protection & other safety tests.

Surge Protection

Upto 3.5 KV(Internal);optional 10KV external SPD

IP

65

RECOMMENDED USAGE

• Parks and Garden Lighting • Pathway Lighting • Street Lanterns

TECHNICAL DETAILS

Model No.	System Wattage	Rated CCT	CRI	Rated Voltage	Power Factor	Dimensions (in mm)		
						O	H	Pole OD
LLSD-30-C	30W	5700K	≥70	240V AC	≥0.95	435	610	78
LLSD-45-C	45W	5700K	≥70	240V AC	≥0.95	435	610	78

CCT's are available in Cool white, Neutral white & Warm white.

PRISTINE

Energy-saving, long-life, aesthetically designed die-cast aluminium landscape luminaire with high-power LED as light source.

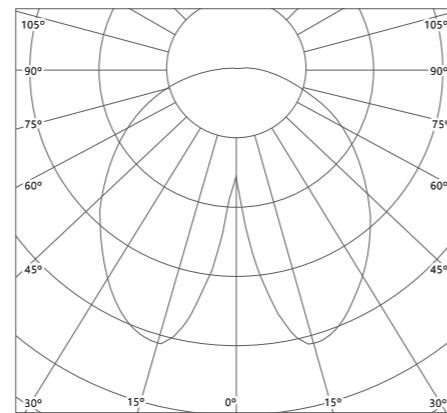

Side View

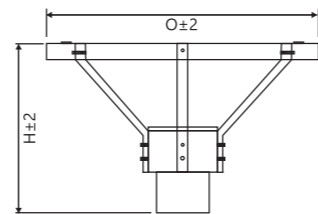

PRODUCT SPECIFICATIONS

Housing

Elegantly designed die-cast aluminium housing and heat sink for efficient thermal management, sturdiness and excellent corrosion resistance. Three nos. die-cast aluminium arms are provided to support the housing. Epoxy powder-coated grey after phosphochromate treatment.

Optics

Opal diffuser is used for glare-free uniform light distribution. High efficiency and long-life LEDs with high lumen efficacies are used.

Mounting

Pole-mounting.

Control Gear

Powered by an integral electronic driver with output Short-Circuit Protection, Surge Protection & other safety tests.

Surge Protection

Up to 3.5 KV (Internal); optional 10 KV external SPD

IP

65

RECOMMENDED USAGE

• Parks and Garden Lighting • Pathway Lighting • Street Lanterns

TECHNICAL DETAILS

Model No.	System Wattage	Rated CCT	CRI	Rated Voltage	Power Factor	Dimensions (in mm)		
						O	H	Pole OD
LLPT-45-C	45W	5700K	≥70	240V AC	≥0.95	400	263	78
LLPT-60-C	60W	5700K	≥70	240V AC	≥0.95	585	365	78

CCT's are available in Cool white, Neutral white & Warm white.

ORBIT

Energy saving, long life aesthetically designed die-cast aluminium landscape luminaire with high power LED as light source.

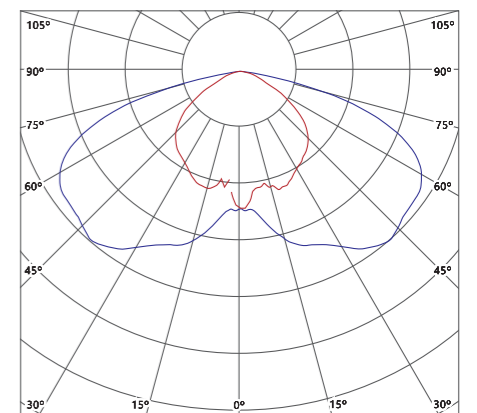

Side View

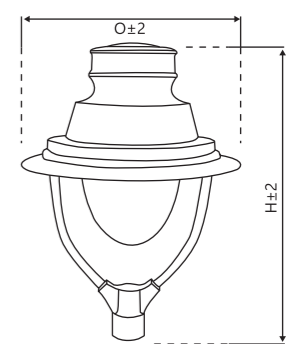

PRODUCT SPECIFICATIONS

Housing

Elegantly designed spun aluminum housing and heat sink for efficient thermal management, sturdiness and excellent corrosion resistance. Two nos. aluminum arms are provided to support the housing. Powder coated black after phosphochromate treatment.

Optics

Opal diffuser is used for glare-free uniform light distribution. High efficiency and long-life LEDs with high lumen efficacies are used.

Mounting

Pole Mounting.

Control Gear

Powered by an integral electronic driver with output short-circuit protection, surge protection & other safety tests.

Surge Protection

Upto 3.5 KV(Internal); optional 10KV external SPD

IP

65

RECOMMENDED USAGE

• Parks and Garden Lighting • Pathway Lighting • Street Lanterns

TECHNICAL DETAILS

Model No.	System Wattage	Rated CCT	CRI	Rated Voltage	Power Factor	Dimensions (in mm)		
						O	H	Pole OD
LLOT-60-C	60W	5700K	≥70	240V AC	>0.95	625	910	75
LLOT-90-C	90W	5700K	≥70	240V AC	>0.95	625	910	75

CCT's are available in Cool white, Neutral white & Warm white.

COMET

Energy saving, long life aesthetically designed die-cast aluminium landscape luminaire with high power LED as light source.

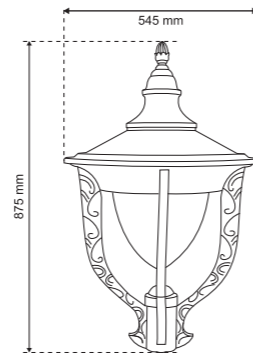
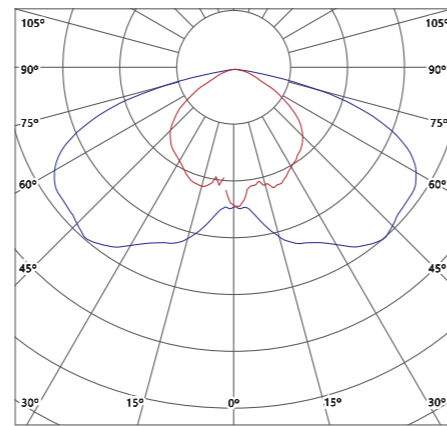

PRODUCT SPECIFICATIONS

Housing

Elegantly designed spun aluminum housing and high grade aluminium heat sink for efficient thermal management, sturdiness and excellent corrosion resistance. Three nos. MS arms are provided to support the housing. Powder coated Black after phosphochromate treatment.

Optics

Opal diffuser is used for glare-free uniform light distribution. High efficiency and long-life LEDs with high lumen efficacies are used.

Mounting

Pole Mounting.

Control Gear

Powered by an integral electronic driver with output short-circuit protection, surge protection & other safety tests.

Surge Protection

Upto 3.5 KV(Internal);optional 10KV external SPD

IP

65

RECOMMENDED USAGE

• Parks and Garden Lighting • Pathway Lighting • Street Lanterns

TECHNICAL DETAILS

Model No.	System Wattage	Rated CCT	CRI	Rated Voltage	Power Factor	Dimensions (in mm)		
						O	H	Pole OD
LLCO-60-C	60W	5700K	≥70	240V AC	≥0.95	545	875	60
LLCO-125-C	125W	5700K	≥70	240V AC	≥0.95	545	875	60

CCT's are available in Cool white, Neutral white & Warm white.



CCMS-CENTRALISED CONTROL & MONITORING SYSTEM

CCMS

Street lighting system controller is a device that automates the entire process, leading to significant energy-saving and convenience.

It provides the capability for remote controlling and monitoring of the street lights, using GPRS technology. The system is fully programmable, and controlled from the controller via a user-friendly web application.

PRODUCT DESCRIPTION

- CCMS consists of two components:
- Gateway
- Web application

FUNCTIONING

- Turning lights on & off
- Sending meter data to web application

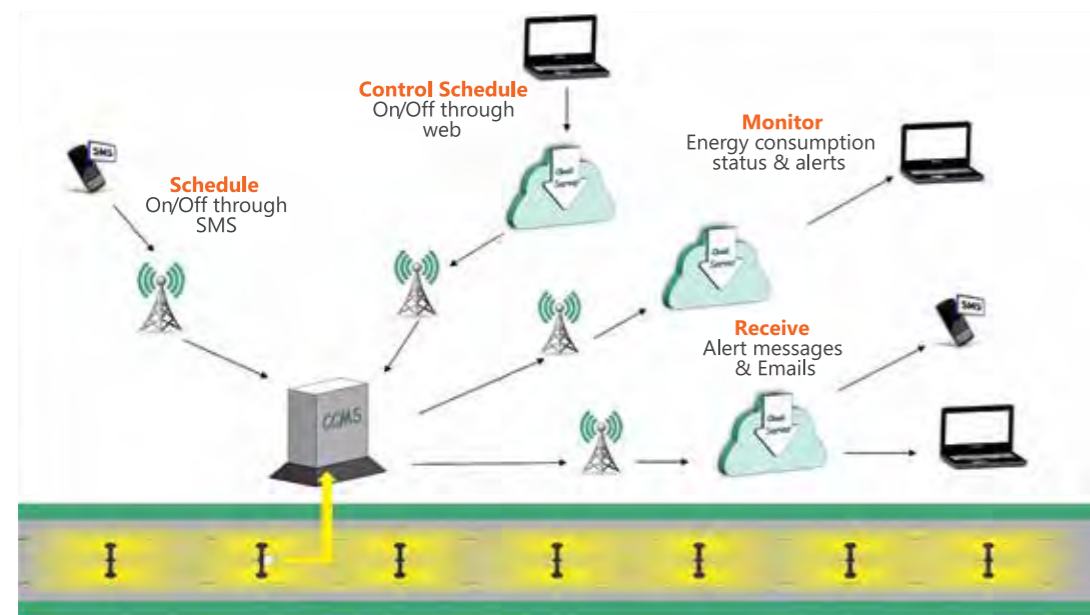

ADVANTAGE

Easy to monitor existing infrastructure of street lighting from the desktop instead of employing dedicated personnel. Changes the status of lights (ON/OFF) from a remote location.

Connects Switch nodes to the web without any additional wiring cost.

Customization can be done to generate custom reports and interfacing new sensors.

Saves energy by turning lights On and OFF as required, instead of manual intervention.

Provides a safe environment for commuters pedestrians and women travelling at late hours by turning on lights automatically at dusk.

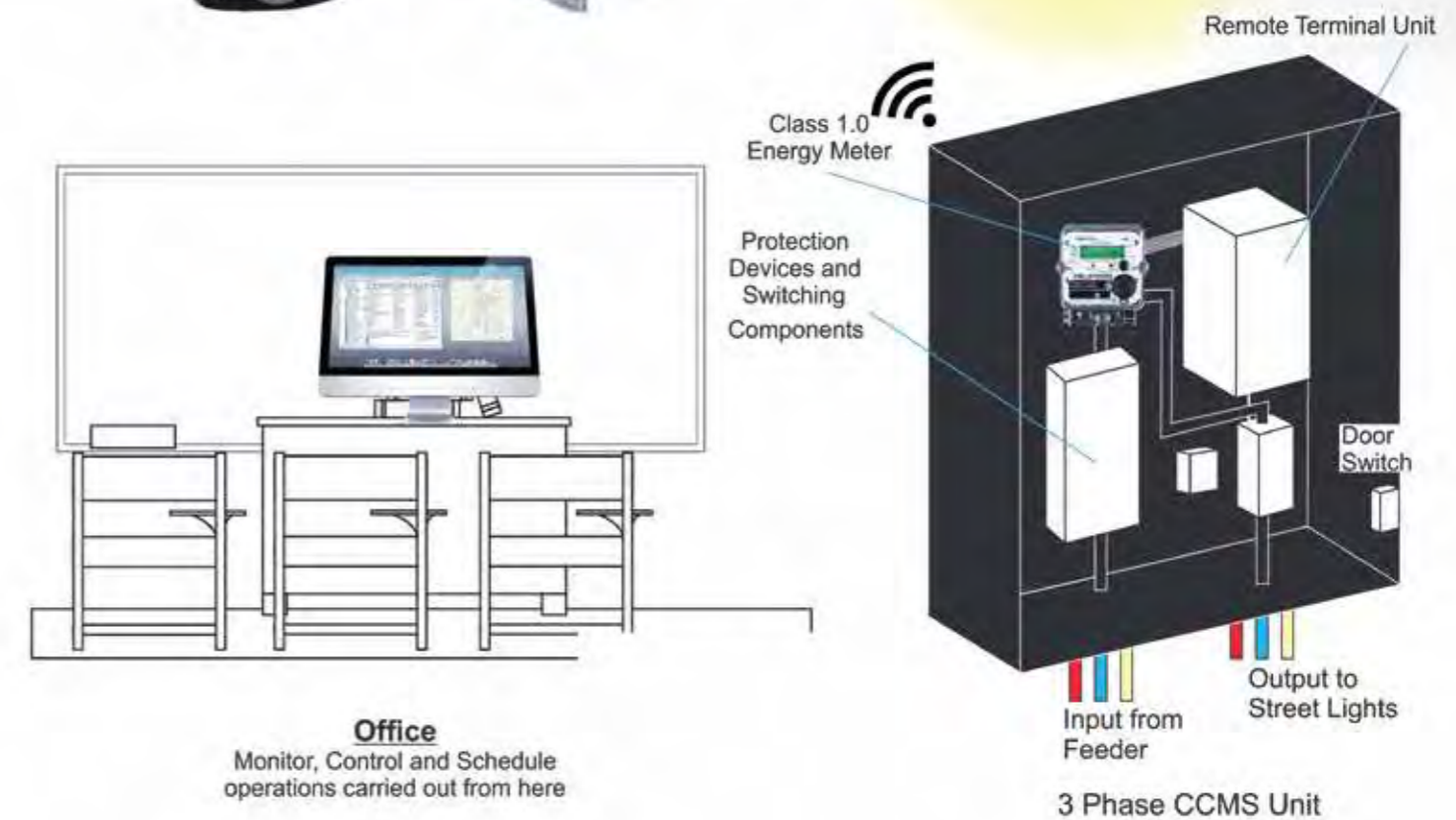

Glossary

AH (Ampere hour)

It is the amount of energy charge in a battery that will allow one ampere of current to flow for one hour. An ampere is a unit of measure of the rate of electron flow or current in an electrical conductor. One ampere of current represents one coulomb of electrical charge moving past a specific point in one second.

Autonomy

The term days of autonomy means the number of days a battery bank can provide the appliances you have connected to the system without a recharged by the solar panels. The system's location is important to determine how the number of "no sun days" which is an important variable to figure out the autonomy.

Average illuminance

Illuminance averaged over a specified surface with respect to area.

Unit: lux (lx) = lm/m²

Symbol: Eavg

Battery

A container consisting of one or more cells, in which chemical energy is converted into electricity and used as a source of power.

Beam Angle

The beam angle of a lamp is the angle at which the light is distributed or emitted.

Brightness

Attribute of visual sensation according to which an area appears to emit more or less light. Brightness according to the definition is also an attribute of color.

Candela

The standard unit of light intensity, abbreviated to "CD", which is one lumen per steradian.
CCT (Correlated color Temperature)

CCT or Correlated Color Temperature is a number, expressed in degrees Kelvin (K) which represents the color of a light source, it is equivalent to the color emitted by a blackbody radiator when heated to that temperature. The CCT value indicates the apparent «warmth» or «coolness» of the light. Common CCTs used for lighting applications are 3000K, 4000K, 5700K & 6500K.

Color rendering

Ability of a light source to render colors naturally, without distorting the hues seen under a full spectrum radiator (like daylight).

CRI (Color Rendering Index)

The color rendering index (CRI) ranges from 0 to 100. It is a quantitative measure of the ability of a light source to reveal the colors of various objects faithfully in comparison with Sunlight (CRI=100)

CRI 90 –100 : Retail, Design work spaces, Inspection areas

CRI 70 –90 : Offices, Residences, café, Schools, Hospitals

CRI below 70: Industrial, Security, Store, Streets, Yards where color fidelity is not so important

DALI

Digital Addressable Lighting Interface, a standardized communication interface to regulate lighting levels and to switch electronic on and off.

Diffuser

To scatter light using diffusion material. Generally, something made of diffusion material that softens the quality of the light passing through it to produce a more flattering light with less noticeable shadows.

Glossary

Discomfort glare

Glare that causes discomfort without necessarily impairing vision.

Electronic LED Driver

An LED driver is a self-contained power supply which regulates the power required for an LED or array of LEDs. The light emitting diodes are low energy, lighting devices with a long lifespan and low energy consumption, hence the requirement for specialized power supplies.

FC

Abbreviation for Flicker Control.

Flicker Control is the technology which reduces the harmful invisible flicker present in the LED lighting source which causes eyestrain, eye-fatigue and many other health complications.

Glare

Glare refers to difficulty seeing or a reduction of visibility in the presence of a bright light

Heat Sink

Heat sinks used with LEDs are designed to absorb and disperse excess heat away from the LED diode and into the heat sink. Passive or active air then circulates around the heat sink to help cool it.

Horizontal Illuminance

Illuminance incident on the horizontal surface.

Unit: lux (lx) = lm/m²

IK Rating

IK Rating or "Impact Protection" (the K is from «Kinetic» to differentiate from IP rating) is defined in international standards and indicates the level of resistance an electrical enclosure provides against mechanical impact.

Illuminance

The luminous flux density at the surface being lit. The Illuminance in the full summer sun is approx. 100 000 lux. Recommended Illuminances for work places range from 200 lux for rough work to 2000 lux for detailed or critical work.

Unit: lux (lx) = lm/m²

Symbol: E

Input Current

LEDs emit light when an input electric current passes through them.

IP (Ingress Protection)

IEC standard 60529, sometimes interpreted as International Protection Code, classifies and rates the degree of protection provided by mechanical casings and electrical enclosures against intrusion, dust, accidental contact, and water.

LED

Light Emitting Diode used as a light source. Solid-state semiconductor device that converts electrical energy directly into light of a specific color or white light.

Light output ratio (LOR)

Ratio of the total light emitted by a luminaire to the total light output of the lamps it contains measured at standard operating conditions.

Lumen depreciation

The decline in the light output of a light source during its lifetime.

Glossary

Luminaire

Appliance that distributes, filters or transforms the light given by a light source (LED), and which contains all the necessary elements for fixing and protecting the light source(s) and facilitates their power supply and operating conditions.

Luminance

The light intensity per square meter of apparent area of the light source, luminaire or illuminated surface. Where surfaces are lit, the luminance depends upon both lighting level and reflection characteristics of the luminous surface.

Unit: cd/m²

Symbol: L

Luminous efficacy

The quantity of light that a light source emits per unit of electrical energy consumed. Notice that the luminous efficacy can be specified for a light source or for a lighting system.

The luminous efficacy of a system is lower than that of the light source.

Unit: lm/W

Luminous flux

The total light output emitted by a light source. Also the total light falling on a surface. The light output of a light source is measured in lumen.

Unit: lumen

Luminous intensity

The luminous flux in a given direction, e.g. from a floodlight or projector.

Unit: candela (cd) = one lumen per steradian

Symbol: I

Lux

The standard unit of illuminance of a surface being lit. One lux equals one lumen per square meter.

Maintenance factor

Correction factor used in lighting design to compensate for the rate of lumen depreciation, caused by lamp ageing (lumen depreciation and lamp failure) and dirt accumulation (luminaire and environment). It determines the maintenance cycle needed to ensure that illuminance does not fall below the maintained value.

Nadir

A point directly below an observer or object. In lighting, the point vertically below a luminaire's lamp source center with the luminaire mounted in standard position with zero tilt or roll.

Optics

The behaviour of light, or the properties of transmission and deflection of light.

Photovoltaics

Photovoltaics are best known as a method for generating electric power by using solar cells to convert energy from the sun into a flow of electrons by the photovoltaic effect

Power factor

Ratio of the circuit power in watts over the product of the root-mean square values of voltage and current. For sinusoidal waveforms, it is equal to the cosine of the angle of phase difference between voltage and current. Power factor close to unity i.e 1 is considered an ideal condition.

RGB

Red, green and blue, used to specify the colors of a light source.

Glossary

Room Reflection Factor

The ratio of the total amount of radiation, as of light, reflected by a surface to the total amount of radiation incident on the surface.

SPD (Surge protection device)

It will act as a voltage controlled switch which will remain passive till system voltage is lower than its activation voltage. When the system (input voltage in case of LED street lights) increases SPDs activation voltage, SPD will divert the surge energy protecting the luminaire.

THD (Total harmonic distortion)

It is a measurement of the harmonic distortion present in a signal and is defined as the ratio of the sum of the powers of all harmonic components to the power of the fundamental frequency.

Thermal Management

At least 70% of the energy put into an LED during operation is converted to heat rather than visible light so, in order to keep the LED junction temperature within its safe operating temperature, this heat needs to be removed quickly. LEDs that operate consistently above their recommended junction temperature run into serious issues. Thus Thermal management by creating heat sinks is essential to keep LEDs cool for harnessing their full potential and ensuring they work efficiently over a long life.

Transverse uniformity

Transverse uniformity is measured across the road along a line passing through the nadir point. It is also defined as the ratio of minimum illumination to the maximum illumination (E_{min}/E_{max}).

Uniformity ratio

Ratio of the minimum over the average illuminance for a specified area (E_{min}/E_{avg}).

Vertical illuminance

Illuminance incident on the vertical surface.

Unit: lux (lx) = lm/m²

Voltage

Voltage is what makes electric charges move. It is the <push> that causes charges to move in a wire or other electrical conductor.

Wattage

A unit of measurement for heat or electrical power.

