



THE FUTURE
OF FANS IS HERE
CATALOGUE 2024

START NOW!

HOME	ABOUT US	PRODUCTS	CONTACT
<u>INTRODUCTION</u>	SAVINGS	MANUFACTURING	MILESTONES AWARDS

ORIENT ELECTRIC

A BRAND THAT STRIVES TO BRING THE BEST OF INNOVATION FOR YOU

We are always in-sync with the changing demands of the modern world and constantly explore new avenues to make life simpler, better, and future-ready. We are already India's favorite one-stop-shop for fans, lighting, home appliances, switchgears, and other electrical solutions, And yet, we're always excited for more - more innovations, more comfort, more elegance. We call it, the Orient way.



The pioneers of change. The market leaders. The Superbrand. We are known by a lot of names but at our core, we are a brand with a singular goal in mind - delighting our consumers with the finest there is to offer! And we've been doing it for 70 years. Our customer-first ideology empowers us to break new barriers in our pursuit of offering better, more innovative solutions. We strive every day to get the right proportions of aesthetics, technology, and performance at your doorstep. At Orient, your comfort and convenience take the front seat, with affordability and functional utility following suit, which is one of the reasons why we're the front-runners in the energy-efficient fans segment.

70 YEARS OF TRUST



HOME

ABOUT US

PRODUCTS

CONTACT

INTRODUCTION

SAVINGS

MANUFACTURING

MILESTONES

AWARDS

THE ERA OF ENERGY-SAVING FANS IS HERE

Did you know that in countries like India, where tropical climates prevail, ceiling fans are crucial for keeping homes cool?

However, their widespread use also comes with a significant energy consumption cost, accounting for approximately 20% of a household's total electricity usage. Recognizing the need for energy conservation, we have introduced our new range of Star - Rated ceiling fans, certified by the Bureau of Energy Efficiency (BEE). These fans are not just about staying cool - they're about staying cool with cool savings.

Our BEE-compliant fans are designed to save you money. With superior energy efficiency, they ensure your comfort without causing the worry of high electricity bills.



HOME	ABOUT US	PRODUCTS	CONTACT
INTRODUCTION	SAVINGS	MANUFACTURING	MILESTONES AWARDS

SAVINGS ARE IN THE AIR WITH ORIENT STAR-RATED FANS

HOW TO CALCULATE STAR-RATING IN FANS?

Air Delivery/Watt = $\frac{\text{Service Value, further Service Value is designated as per BEE norms}}{\text{Watt}}$

Slabs (Service Value)	Star Rating	Annual Savings (INR) *
≥4.0 < 4.5	1 Star	861
≥4.5 < 5.0	2 Star	1096
≥5.0 < 5.5	3 Star	1291
≥5.5 < 6.0	4 Star	1448
≥6.0	5 Star	1761

*Orient fans compared to non star induction motor fans. Calculated basis electricity rates @`6.7/unit

 <p>Redesigned motor for less power consumption</p>	 <p>BEE Certification from NABL Approved Labs</p>	 <p>Added safety wire</p>
--	--	--

HOME

ABOUT US

PRODUCTS

CONTACT

INTRODUCTION

SAVINGS

MANUFACTURING

MILESTONES

AWARDS

STATE-OF-THE-ART FAN MANUFACTURING FACILITIES

With exclusive manufacturing facilities in Faridabad, Noida, and Kolkata, we take the lead in introducing pioneering products to the market and establishing new standards of excellence. As we prepare to inaugurate our cutting-edge fan production facility in Hyderabad, we remain eager to redefine industry benchmarks once again.



We draw a sizable advantage from our state-of-the-art proprietary manufacturing facilities for fans at Faridabad and Kolkata, which enables us to manufacture first-to-market products with best-in-class quality and performance. Quality being the key driving force behind everything we do at Orient Electric, we conscientiously follow the Six Sigma processes to manufacture zero-defect products.

Our sustained investments in building up competence and innovation centers have helped not only to bring differentiation but also bring down costs. We have a huge acceptability of our products in the international markets. Today, we are one of the largest exporter of fans from India with a strong marketing presence in over 35 international markets.

HOME

ABOUT US

PRODUCTS

CONTACT

INTRODUCTION

SAVINGS

MANUFACTURING

MILESTONES

AWARDS

Orient Electric Milestones



1954

Included into the CK Birla Group. Renamed as Orient Fans.



1969

Established a factory in Faridabad.



switch to smart

2014

Unveiled new brand identity. Rebranded as Orient Electric with the positioning statement of 'Switch to Smart'.

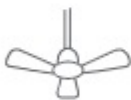

2016

Unveiled the 'Very Silent Very Powerful' Aeroquiet premium ceiling fan.



2018

Got listed on the stock exchanges.



2020

Entered the Fortune India 500[®] list.

1939

The journey begins. Factory established in Kolkata.



1965

Became the first Indian company to introduce die-casting of the rotor and fan body cover in ceiling fans.



1990

Developed and patented the revolutionary PSPO technology for fans.



2014

Unveiled energy-efficient BLDC fans.



2017

Demerged and got listed as a separate entity.



2019

Unveiled India's first smart ceiling fan (Aerosim).



2023

Launched first-of-its-kind Cloud 3 fan with Cloudchill technology.



HOME

ABOUT US

PRODUCTS

CONTACT

INTRODUCTION

SAVINGS

MANUFACTURING

MILESTONES

AWARDS

ACCOLADES AS GLORIOUS AS OUR RANGE

At Orient Electric, we have a great story to tell. As an enduring enterprise, we have been creating value consistently for more than six decades. And we are honoured to have been recognized time and again for our accomplishments as a consumer electricals major, a great employer, and a responsible corporate entity. We continue to be a consumer-validated 'Superbrand' for Fans, Air Coolers, and Lighting. In recent times, we have been conferred with many other illustrious awards and recognitions including, Most Trusted Brands of India 2023.

We have been accorded the Prestigious Brands of Asia 2021-22, The Economic Times Iconic Brands of India 2022, and the National Energy & Conservation Award 2021, just to name a few. We have also been consistently granted 'Star Performer' by the Engineering Export Promotion Council (EEPC) and rated as a 'Star Export House' by the Ministry of Commerce and Industry, Government of India.

Additionally, we continue to retain our 'Great Place to Work' certification since 2020 which endorses our commitment to sustaining a high-performance and people-centric culture.

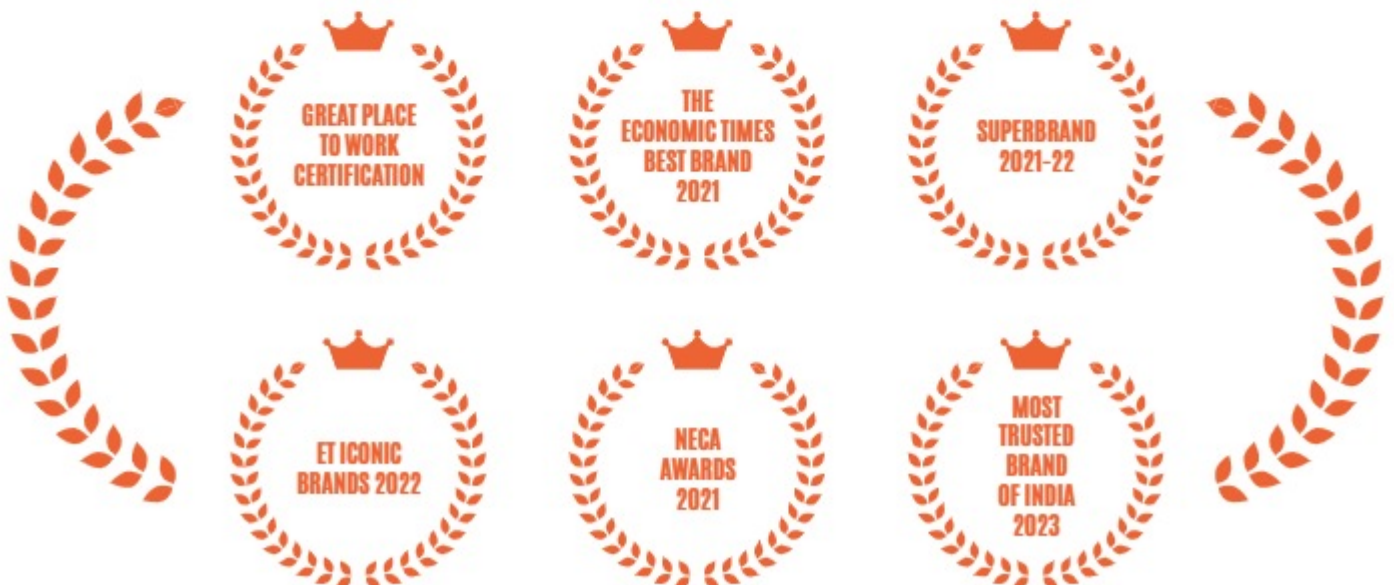

HOME

ABOUT US

PRODUCTS

CONTACT



Aero Series



BLDC Fans



Underlight Fans



Decorative Fans



Lifestyle Fans



Table, Pedestal & Wall Fans



Exhaust Fans



Industrial Fans



Product Comparison

[HOME](#)[ABOUT US](#)[PRODUCTS](#)[CONTACT](#)

AERO SERIES



Presenting to you Aero Series - Orient Electric's range of premium ceiling fans that feature a revolutionary aerodynamic blade design for an unparalleled performance. A sleek & stylish silhouette, advanced technology, and exceptional airflow - these fans have it all. The blades of these fans draw inspiration from the wings of airplanes that are crafted with precision to give superior airflow that reaches even the farthest corners of your room while keeping the operation whisper quiet.

[PRODUCTS](#)

HOME

ABOUT US

PRODUCTS

CONTACT

AERO SERIES



AEROSLIM BLDC



AERONSENSE BLDC



AEROQUIET BLDC



AEROQUIET



AEROSTORM BLDC



AEROSTORM

HOME

ABOUT US

PRODUCTS

CONTACT

AERO SERIES

AEROSLIM BLDC

 Ceiling adjustable telescopic mounting

 2 way rotation for summer and winter

 Easy to clean PU finish

 Rust proof and bend proof ABS blades

 Aerodynamic slim design

 3 Years warranty

 **IOT**
ENABLED India's first IoT-enabled fan supports both Google Assistant and Amazon Alexa

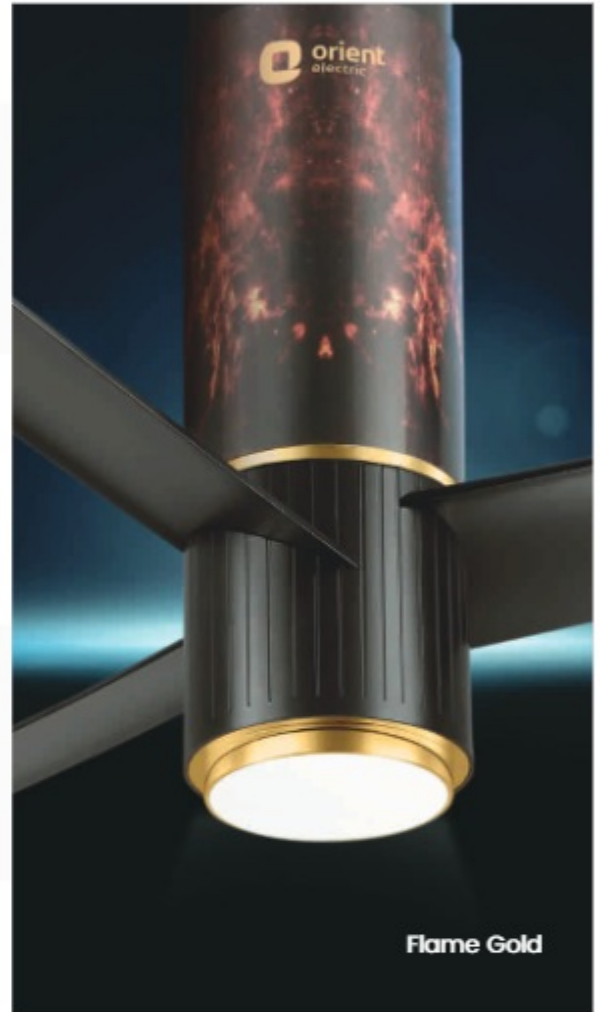

Sweep (mm)	Air Delivery (CMM)	RPM	Power (w)
1200	260	310	40

*On using four fans for 16 hours daily throughout one year.

orient
BLDC FANS



save upto
7000
annually*

< BACK

www.orientelectric.com

NEXT >

AERO SERIES

AEROSENSE BLDC



save upto
7000
annually*

orient
BLDC FANS

Aerosense is the latest entrant in our Aero Series- Orient Electric's flagship series of premium ceiling fans. Inspired by the aerodynamic wings of airplanes, Aerosense redefines comfort and convenience with its futuristic features. It is IoT enabled for effortless control via voice commands or smartphone taps from anywhere in your home. With fluidic blade design and premium PU finish, it's not just easy to maintain but also enhances modern interiors. This all-season fan provides two-way rotation for year-round comfort, circulating cool air in summers and warm air in winters.

 2 way rotation for summer and winter

 Easy to clean PU finish

 Aerodynamic slim design

 **IOT** ENABLED
India's first IoT-enabled fan supports both Google Assistant and Amazon Alexa

COMES IN TWO VARIANTS
WITH AND WITHOUT UNDERLIGHT

Sweep (mm)	Air Delivery (CMM)	RPM	Power (w)
1200	245	280	40

*On using four fans for 16 hours daily throughout one year.

HOME

ABOUT US

PRODUCTS

CONTACT

AERO SERIES

AEROQUIET BLDC

-  High air delivery
-  Aerodynamic & slim design
-  Whisper quiet fan
-  Easy to clean PU finish
-  Rust proof and bend proof ABS blades
-  5 Years warranty



White

Sweep (mm)	Air Delivery (CMM)	RPM	Power (w)
1200	225	310	35

On using four fans for 16 hours daily throughout one year.

orient
BLDC FANS



save upto
7000
annually*

Contd...

< BACK

www.orientelectric.com

NEXT >

HOME

ABOUT US

PRODUCTS

CONTACT

AERO SERIES

AEROQUIET BLDC



Roasted Coffee



Mystic Gold



Caramel Brown



Matt Black



Daytone Grey



Wooden Finish

AERO SERIES

AEROQUIET

-  Aerodynamic slim design
-  Whisper quiet fan
-  High air delivery
-  Easy to clean PU finish
-  Bend proof high grade ABS blades
-  Strong & durable 18 pole motor
-  2 Years warranty



White Rose Gold

Sweep (mm)	Air Delivery (CMM)	RPM	Power (w)
900	150	430	48
1200	225	310	55



Contd...

HOME

ABOUT US

PRODUCTS

CONTACT

AERO SERIES

AEROQUIET



Roasted Coffee



Pinewood



Mystic Gold



White



Matt Black



Daytone Grey



Orbes white



Caramel Brown



Wooden Finish

900mm comes only in two colors Caramel Brown and White

HOME

ABOUT US

PRODUCTS

CONTACT

AERO SERIES

AEROSTORM BLDC

 Advance winglet technology

 High air delivery of 245CMM

 Whisper quiet fan

 Bend proof high grade ABS blades

 Easy to clean PU finish

 5 Years warranty

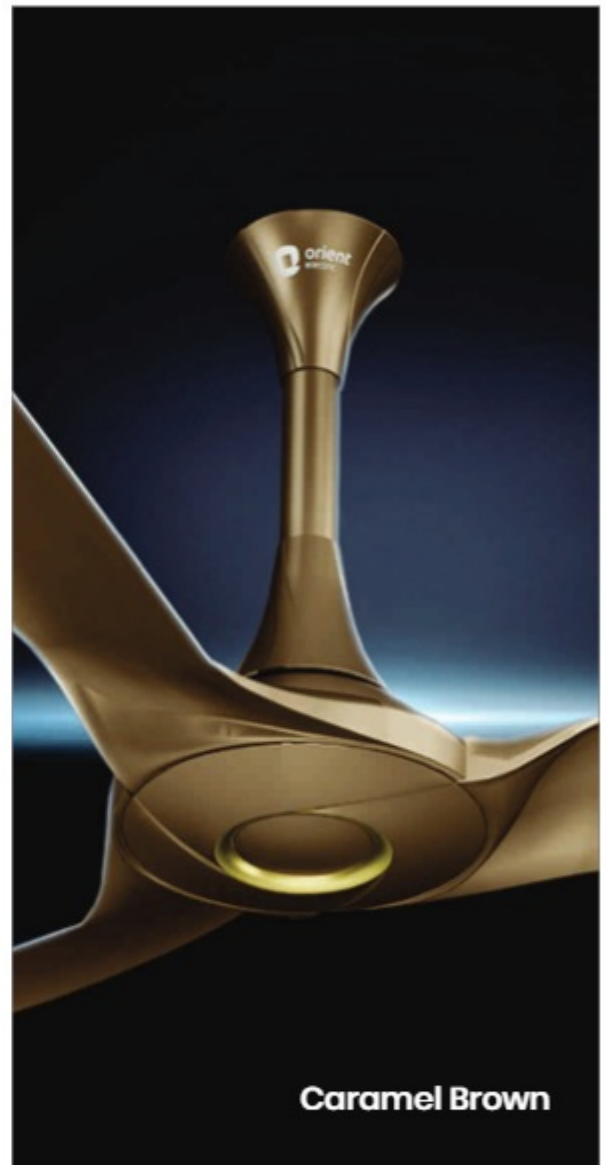

*On using four fans for 16 hours daily throughout one year.

Sweep (mm)	Air Delivery (CMM)	RPM	Power (w)
1200	245	290	40

orient
BLDC FANS



save upto
7000
annually*

< BACK

www.orientelectric.com

NEXT >

HOME

ABOUT US

PRODUCTS

CONTACT

AERO SERIES

AEROSTORM

 Advance winglet technology

 High air delivery

 Whisper quiet fan

 Bend proof high grade ABS blades

 Easy to clean PU finish

 Strong & durable 18 pole motor

 2 Years warranty

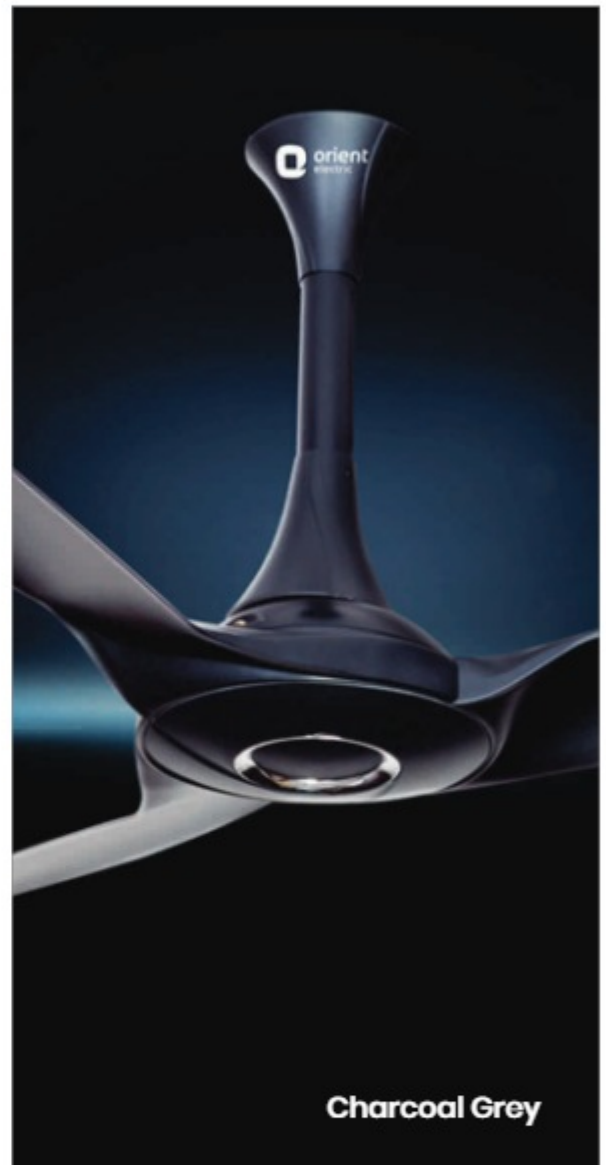
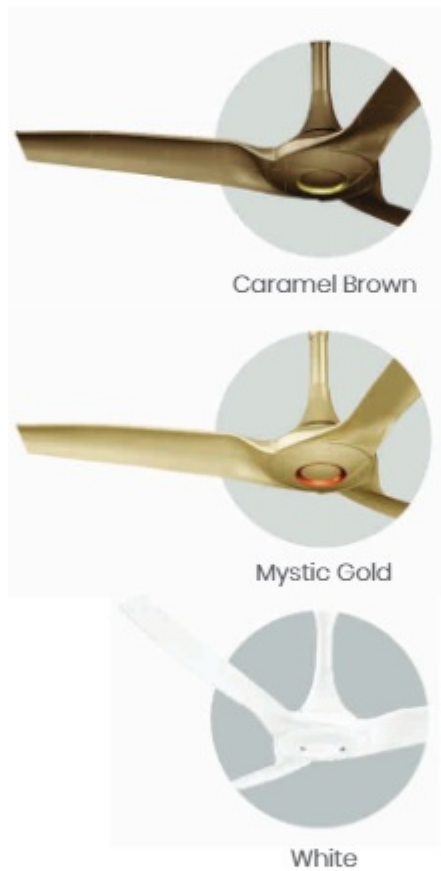

Sweep (mm)	High Air Delivery	RPM	Power (w)
1320	300	270	75



BLDC FANS

orient
BLDC FANS

ENERGY SAVING SERIES

Experience the future of fan technology with Orient's Energy Saving Series, featuring Brushless Direct Current (BLDC) motors. BLDC motors use permanent magnets for efficient electricity transfer, minimizing heat loss and component wear. Revolutionizing efficiency, durability, and sustainability, BLDC fans redefine comfort and conservation. Upgrade now to experience the lasting difference firsthand.



EXPERIENCE THE FUTURE OF COMFORT

Our fans are a unique combination of futuristic features, revolutionary BLDC technology and exquisite craftsmanship. Experience whisper-quiet operation, voice control, and effortless remote functionality. With enhanced motor durability, reduced noise, and doubled efficiency, Orient BLDC fans redefine comfort while significantly cutting electricity bills.

PRODUCTS



Up to 50%
Energy Saving



Low Noise
Operation



Powerful
Air Delivery



Works on
Low Voltage

HOME

ABOUT US

PRODUCTS

CONTACT

BLDC FANS



AEON BLDC



AEROSLIM BLDC



AEROSTORM BLDC



AEROQUIET BLDC



I FLOAT BLDC IoT



I FLOAT BLDC



ECOTECH SUPEREME REMOTE



ECOTECH SUPEREME



ECOTECH PRIME BLDC

Contd...

HOME

ABOUT US

PRODUCTS

CONTACT

BLDC FANS



I FALCON BLDC



I FALCON REMOTE BLDC



I FALCON DECO BLDC



HECTOR 500



HECTOR 500 REMOTE



HECTOR DECO



JAZZ BLDC



WENDY BLDC

HOME

ABOUT US

PRODUCTS

CONTACT

BLDC FANS

AEON BLDC

-  High air delivery of 225 CMM
-  Modern blade design with premium metallic finishes
-  Dual toned bottom with chrome ring finish
-  Anti-dust
-  5 Years warranty



*On using four fans for 16 hours daily throughout one year.

Sweep (mm)	Air Delivery (CMM)	RPM	Power (w)
1200	225	350	32



save upto
7000
annually*

orient
BLDC FANS

Contd...

< BACK

www.orientelectric.com

NEXT >

HOME

ABOUT US

PRODUCTS

CONTACT

BLDC FANS

AEON BLDC



Pixel White



Cloud Grey



Platinum Silver



Magma Grey



Knight Blue

HOME

ABOUT US

PRODUCTS

CONTACT

BLDC FANS

AEROSLIM BLDC

 Ceiling adjustable telescopic mounting

 2 way rotation for summer & winter

 Easy to clean PU finish

 Rust proof and bend proof ABS blades

 Aerodynamic & slim design

 3 Years warranty

 **IOT**
ENABLED India's first IoT-enabled fan supports both Google Assistant and Amazon Alexa



White

Champagne Brown

Marble White

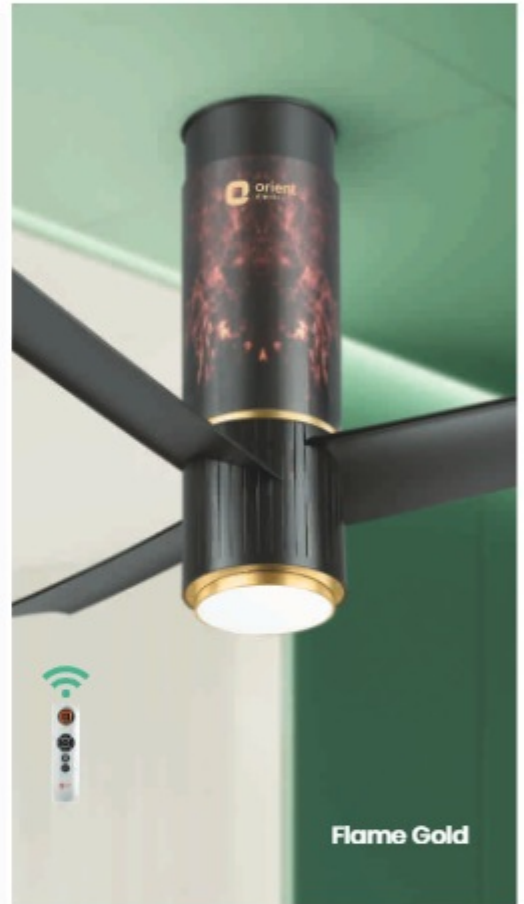

Flame Gold

*On using four fans for 16 hours daily throughout one year.

Sweep (mm)	Air Delivery (CMM)	RPM	Power (w)
1200	260	310	40



save upto
7000
annually*

orient
BLDC FANS

< BACK

www.orientelectric.com

NEXT >

BLDC FANS

AEROSTORM BLDC

-  Advance winglet technology
-  High air delivery of 245 CMM
-  Whisper quiet fan
-  Bend proof high grade ABS blades
-  Easy to clean PU finish
-  5 Years warranty



Caramel Brown



Charcoal Grey



Mystic Gold



White

*On using four fans for 16 hours daily throughout one year.

Sweep (mm)	Air Delivery (CMM)	RPM	Power (w)
1200	245	290	40



save upto
7000
annually*

orient
BLDC FANS

BLDC FANS

AEROQUIET BLDC

-  High air delivery
-  Aerodynamic & slim design
-  Whisper quiet fan
-  Easy to clean PU finish
-  Rust proof and bend proof ABS blades
-  5 Years warranty



*On using four fans for 16 hours daily throughout one year.

Sweep (mm)	Air Delivery (CMM)	RPM	Power (w)
1200	225	310	35



save upto
7000
annually*

orient
BLDC FANS

Contd...

HOME

ABOUT US

PRODUCTS

CONTACT

BLDC FANS

AEROQUIET BLDC

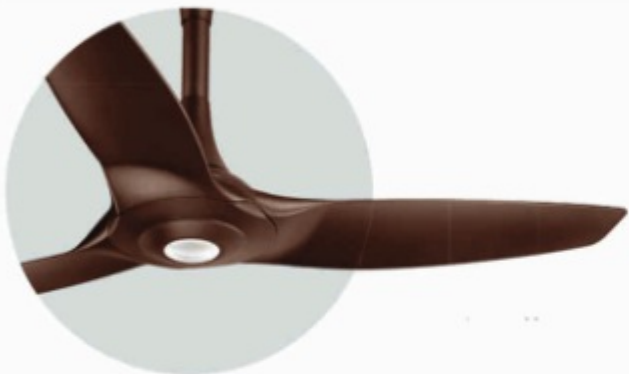

Roasted Coffee



Mystic Gold



Caramel Brown



Matt Black



Daytone Grey



Wooden Finish

BLDC FANS

i FLOAT BLDC IoT

-  Unique floating blade design to suit modern interiors
-  2 way rotation for summer & winter
-  Aerodynamic blade designed to lower air-cutting noise
-  Consistent performance even with fluctuating voltages (120V – 280V)
-  3 Years warranty
-  **IOT ENABLED** India's first IoT-enabled fan supports both Google Assistant and Amazon Alexa



*On using four fans for 16 hours daily throughout one year.

Sweep (mm)	Air Delivery (CMM)	RPM	Power (w)
1200	215	330	32



save upto
7000
annually*

orient
BLDC FANS

BLDC FANS

i FLOAT BLDC



Compatible with regulator



Unique floating blade design to suit modern interiors



Aerodynamic blade designed to lower air-cutting noise



Consistent performance even with fluctuating voltages (140V - 270V)



2X runtime on inverter**



3 Years warranty

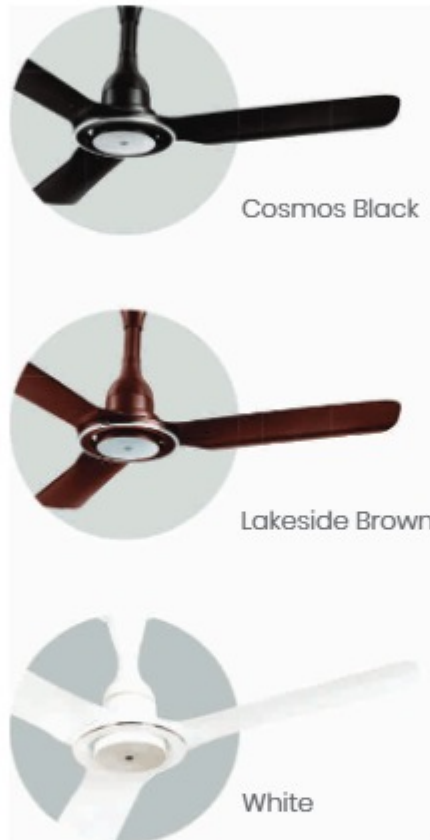

Cosmos Black

Lakeside Brown

White



Space Grey

*On using four fans for 16 hours daily throughout one year.
**As compared to an induction fan.

Sweep (mm)	Air Delivery (CMM)	RPM	Power (w)
1200	215	330	32



save upto
7000
annually*

orient
BLDC FANS

HOME





ABOUT US

PRODUCTS

CONTACT

BLDC FANS

ECOTECH SUPREME REMOTE

-  High speed BLDC fan with 370 RPM
-  Rust proof aluminium blades
-  Consistent performance even with fluctuating voltages (120V - 280V)
-  2X runtime on inverter**
-  3 Years warranty



*On using four fans for 16 hours daily throughout one year.
**As compared to an induction fan.

Sweep (mm)	Air Delivery (CMM)	RPM	Power (w)
1200	220	370	28



save upto
7000
annually*

orient
BLDC FANS

< BACK

www.orientelectric.com

NEXT >

BLDC FANS

ECOTECH SUPREME

-  Compatible with regulator
-  High-speed BLDC fan with 370 RPM
-  Rust proof aluminium blades
-  Consistent performance even with fluctuating voltages (140V – 270V)
-  2X runtime on inverter**
-  3 Years warranty



White

Topaz Gold

Metallic Bronze Copper

Brown



Wooden Finish

*On using four fans for 16 hours daily throughout one year. consumption. **As compared to an induction fan.

Sweep (mm)	Air Delivery (CMM)	RPM	Power (w)
1200	220	370	30







save upto
7000
annually*

orient
BLDC FANS

BLDC FANS

ECOTECH PRIME BLDC

-  Dual-tone textured bottom with ring for contemporary interiors
-  Rust proof aluminium blades
-  Consistent performance even with fluctuating voltages (120V - 280V)
-  2X runtime on inverter**
-  3 Years warranty

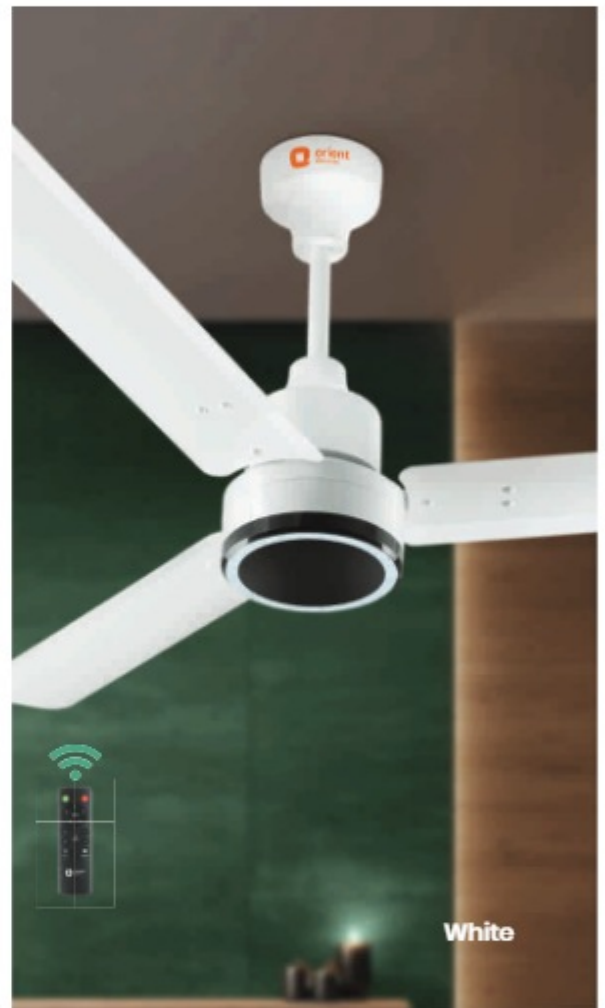
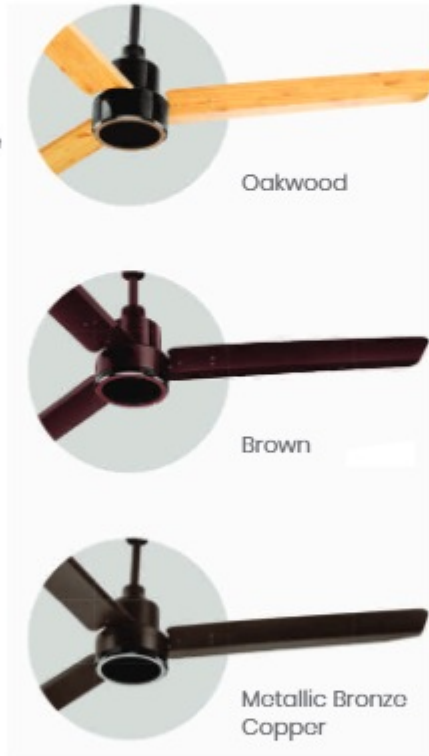

*On using four fans for 16 hours daily throughout one year.
**As compared to an induction fan.

Sweep (mm)	Air Delivery (CMM)	RPM	Power (w)
1200	220	350	32



save upto
7000
annually*

orient
BLDC FANS

BLDC FANS

i FALCON BLDC



Wide tipped blades for high air delivery (225 CMM)



Compatible with regulator



Rust proof aluminium blades



Consistent performance even with fluctuating voltages (140V - 270V)



2X runtime on inverter**



3 Years warranty

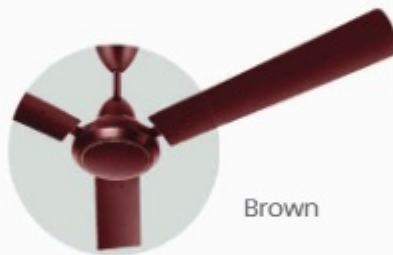

Brown



Metallic Bronze Copper



White

*On using four fans for 16 hours daily throughout one year.
**As compared to an induction fan.

Sweep (mm)	Air Delivery (CMM)	RPM	Power (w)
1200	225	350	32



save upto
7000
annually*

orient
BLDC FANS

BLDC FANS

i FALCON REMOTE BLDC



Comes with speed indicator LED lights



Wide tipped blades for high air delivery (225 CMM)



Rust proof aluminium blades



Consistent performance even with fluctuating voltages (120V - 280V)



2X runtime on inverter**



3 Years warranty



White



Brown

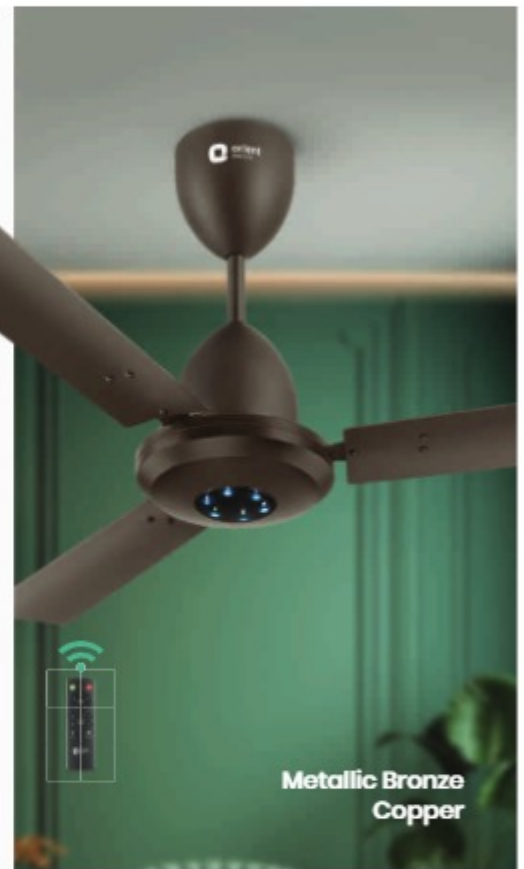

Metallic Bronze Copper

*On using four fans for 16 hours daily throughout one year.
**As compared to an induction fan.

Sweep (mm)	Air Delivery (CMM)	RPM	Power (w)
1200	225	350	32



save upto
7000
annually*

orient
BLDC FANS

BLDC FANS

i FALCON DECO BLDC



Decorative trims to suit contemporary décor



Wide tipped blades for high air delivery (225 CMM)



Rust proof aluminium blades



Consistent performance even with fluctuating voltages (120V – 280V)



2X runtime on inverter**



3 Years warranty



White



Metallic Bronze Copper

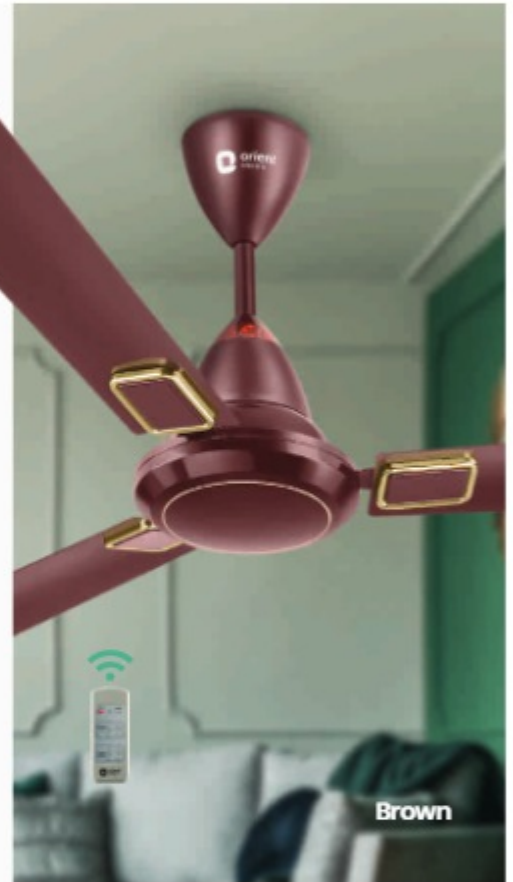

Brown

*On using four fans for 16 hours daily throughout one year.
**As compared to an induction fan.

Sweep (mm)	Air Delivery (CMM)	RPM	Power (w)
1200	225	350	30



save upto
7000
annually*

orient
BLDC FANS

BLDC FANS

HECTOR 500



Wide tipped blades for high air delivery (230 CMM)



Compatible with regulator



Rust proof aluminium blades



Consistent performance even with fluctuating voltages (140V - 270V)



2X runtime on inverter**



3 Years warranty

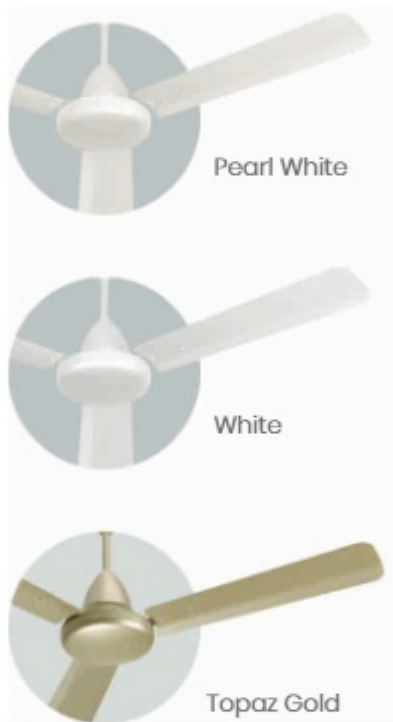

Pearl White

White

Topaz Gold



Brown

*On using four fans for 16 hours daily throughout one year.
**As compared to an induction fan.

Sweep (mm)	Air Delivery (CMM)	RPM	Power (w)
900mm	140	450	25
1200mm	230	350	32
1400mm	260	300	35



save upto
7000
annually*

orient
BLDC FANS

HOME

ABOUT US

PRODUCTS

CONTACT

BLDC FANS

HECTOR 500 REMOTE



Wide tipped blades for high air delivery (230 CMM)



Rust proof aluminium blades



Consistent performance even with fluctuating voltages (120V – 280V)



2X runtime on inverter**



5 Years warranty

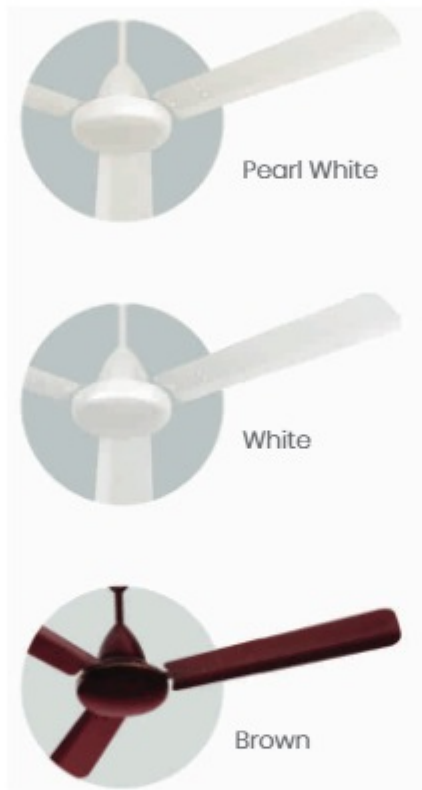

Pearl White

White

Brown



Topaz Gold

*On using four fans for 16 hours daily throughout one year.
**As compared to an induction fan.

Sweep (mm)	Air Delivery (CMM)	RPM	Power (w)
1200	230	350	28



save upto
7000
annually*

orient
BLDC FANS

< BACK

www.orientelectric.com

NEXT >

BLDC FANS

HECTOR DECO

 Decorative ring and trims to suit contemporary décor

 Wide tipped blades for high air delivery (230 CMM)

 Rust proof aluminium blades

 Consistent performance even with fluctuating voltages (120V – 280V)

 2X runtime on inverter**

 5 Years warranty

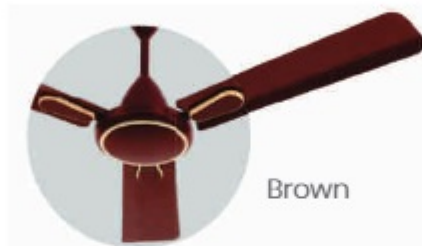

Brown



Metallic Bronze Copper



White

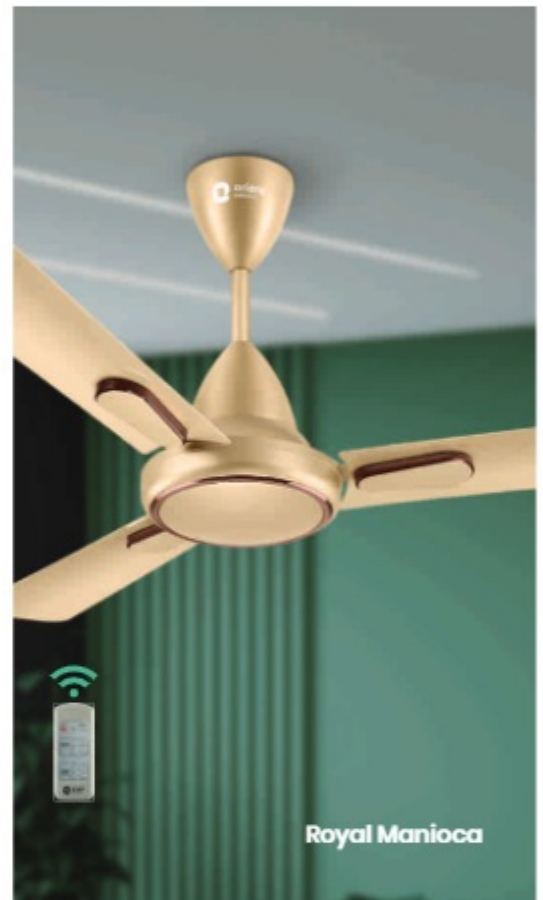

Royal Manioca

*On using four fans for 16 hours daily throughout one year.
**As compared to an induction fan.

Sweep (mm)	Air Delivery (CMM)	RPM	Power (w)
1200	230	350	30



save upto
7000
annually*

orient
BLDC FANS

HOME

ABOUT US

PRODUCTS

CONTACT

BLDC FANS

JAZZ BLDC

 Fluidic trim design

 Rust proof aluminium blades

 Consistent performance even with fluctuating voltages (120V - 280V)

 2X runtime on inverter**

 3 Years warranty

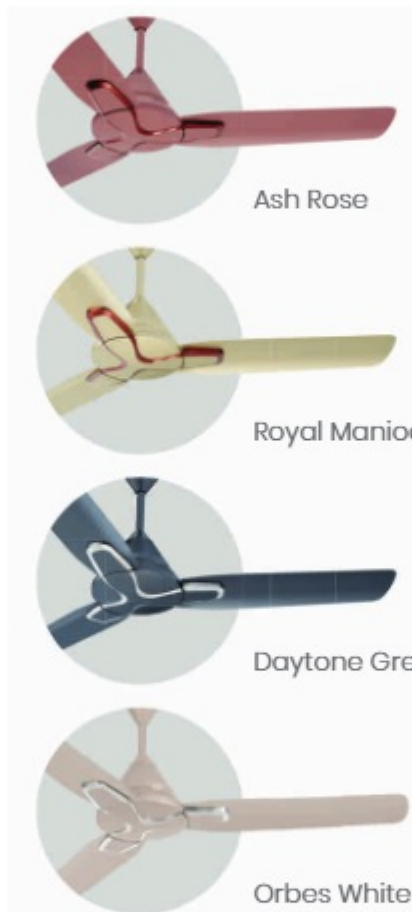

Ash Rose

Royal Manioca

Daytone Grey

Orbes White



Metallic Bronze Copper

*On using four fans for 16 hours daily throughout one year.
**As compared to an induction fan.

Sweep (mm)	Air Delivery (CMM)	RPM	Power (w)
1200	215	350	33



save upto
7000
annually*

orient
BLDC FANS

BLDC FANS

WENDY BLDC

-  Unique trim design for elegant home décor
-  Wide tipped blades for high air delivery (230 CMM)
-  Rust proof aluminium blades
-  Consistent performance even with fluctuating voltages (120V – 280V)
-  2X runtime on inverter**
-  3 Years warranty

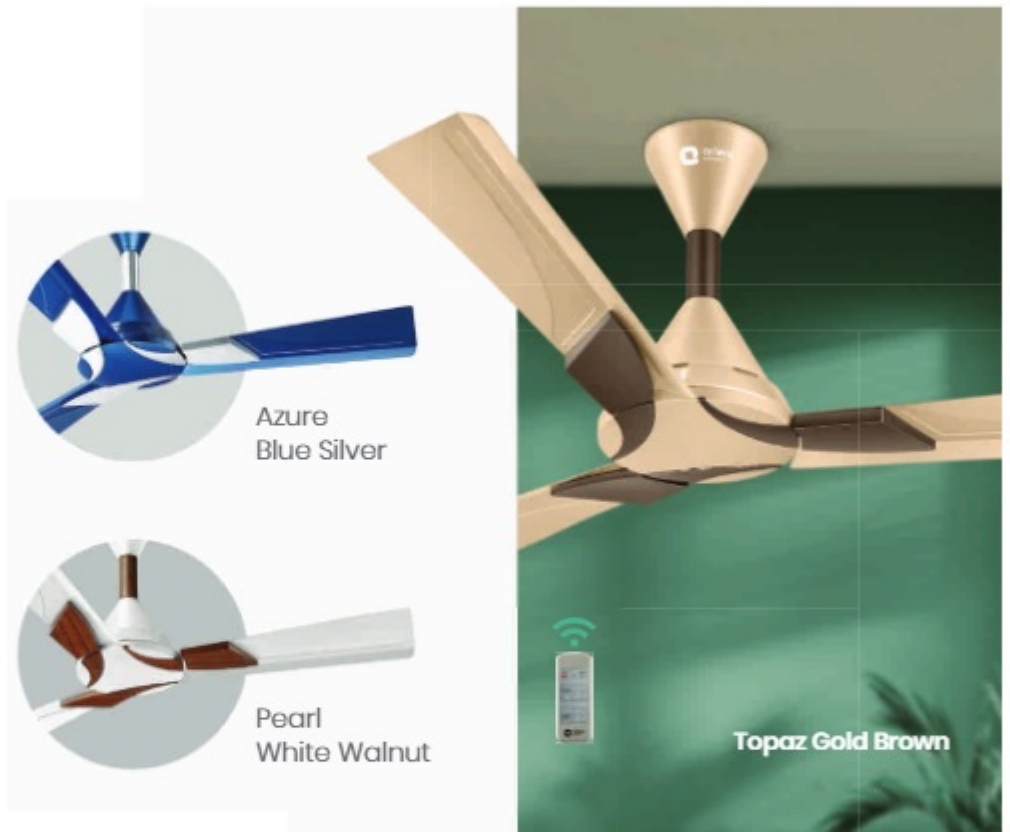

*On using four fans for 16 hours daily throughout one year.
**As compared to an induction fan.

Sweep (mm)	Air Delivery (CMM)	RPM	Power (w)
1200	230	350	35



save upto
7000
annually*

orient
BLDC FANS

[HOME](#)[ABOUT US](#)[PRODUCTS](#)[CONTACT](#)

UNDERLIGHT FANS



UNDERLIGHT FANS

LET YOUR SPACE GLOW WITH OPULENCE

Dive into our diverse selection of fans, crafted with built-in lighting that adds to their elegance and functionality. Each fan is meticulously crafted to complement your lavish interiors. The Underlight Series is an impeccable fusion of functionality and aesthetics, delivering both a refreshing breeze and stunning radiance. Elevate your living spaces with the epitome of luxury, where every detail is designed to enhance the grandeur of your home.

[PRODUCTS](#)

HOME

ABOUT US

PRODUCTS

CONTACT

UNDERLIGHT FANS



ELEGANZA



AEROSLIM BLDG



SPECTRA



SUBARIS REMOTE



SUBARIS SOLO



WOODWIND

HOME

ABOUT US

PRODUCTS

CONTACT

UNDERLIGHT FANS

ELEGANZA

EXPERIENCE ELEGANCE
IN EVERY SPIN



Eleganza EZ 02
AIR CIRCULATOR



Eleganza EZ 01
AIR CIRCULATOR



Mood lighting
(White, Yellow, Mix)



With remote



High quality
crystals



Provides
air circulation



2 Years warranty
on motor





Designer transparent
retractable blades

UNDERLIGHT FANS

AEROSLIM BLDC

 Ceiling adjustable telescopic mounting

 2 way rotation for summer and winter

 Easy to clean PU finish

 Rust proof and bend proof ABS blades

 Aerodynamic slim design

 3 Years warranty

 **IOT** ENABLED
India's first IoT enabled fan supports both Google Assistant and Amazon Alexa

*On using four fans for 16 hours daily throughout one year.

Sweep (mm)	Air Delivery (CMM)	RPM	Power (w)
1200	260	310	40



save upto
7000
annually*

orient
BLDC FANS

HOME

ABOUT US

PRODUCTS

CONTACT

UNDERLIGHT FANS

SPECTRA

 Premium electroplated finish



 Dimmable LED light

 Timer & 5-speed control through remote

 Automatic and manual colour changing mechanism for lights

 2 Years warranty

3 colour lights for different moods

 Warm White  Natural White  Cool White



Pewter Finish

Brushed Brass

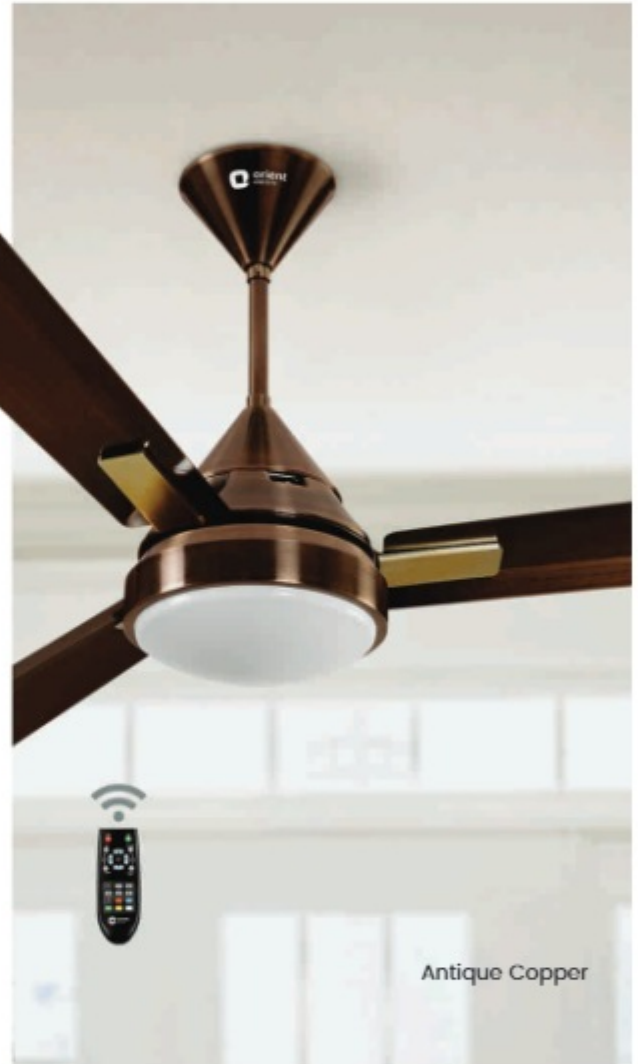

Antique Copper

Sweep (mm)	Air Delivery (CMM)	RPM	Power (w)
1200	230	320	57

HOME

ABOUT US

PRODUCTS

CONTACT

UNDERLIGHT FANS

SUBARIS REMOTE

 High air delivery

 Built in timer for 2,4,6 and 8 hours

 Classic glass lamp shades

 Rust proof aluminium blades

 Premium electroplated finish

 2 Years warranty



Wooden Finish
Antique Brass



Wooden Finish
Antique Copper



Matt White
Antique Gold

Sweep (mm)	Air Delivery (CMM)	RPM	Power (w)
1300	270	250	67

HOME

ABOUT US

PRODUCTS

CONTACT

UNDERLIGHT FANS

SUBARIS SOLO

 High air delivery

 Classic glass lamp shades

 Rust proof aluminium blades

 Premium electroplated finish

 All season fan with reverse rotation

 2 Years warranty



Sweep (mm)	Air Delivery (CMM)	RPM	Power (w)
1300	270	250	67

HOME

ABOUT US

PRODUCTS

CONTACT

UNDERLIGHT FANS

WOODWIND

AIR CIRCULATOR

-  5 Blades for high air delivery
-  Wooden blades for premium aesthetics
-  Trendy glass shade for light
-  Premium metallic bronze paint finish
-  Capacitor based speed control
-  2 Years warranty



Sweep (mm)	Air Delivery (CMM)	RPM	Power (w)
1300	215	220	80

DECORATIVE FANS



DECORATIVE FANS

FROM BUSY TO BREEZY,
IN A HEARTBEAT.

Orient's impressive range of decorative fans is a collection that seamlessly marries aesthetic appeal with functional efficiency, offering you the perfect blend of style and substance to leave you mesmerized. Their meticulous design and cutting-edge technology transform your living spaces into a haven of elegance and comfort. So bring home a beauty that truly stands out.

PRODUCTS

HOME

ABOUT US

PRODUCTS

CONTACT

DECORATIVE FANS



MOZART



JAZZ



JAZZ ART



WENDY



BLANCO



ARINA



SUBARIS ROYAL



STALLION



QUASAR

Contd...

< BACK

www.orientelectric.com

NEXT >

HOME

ABOUT US

PRODUCTS

CONTACT

DECORATIVE FANS



QUADRO ORNAMENTAL



QUASAR ORNAMENTAL



MORACE



KIARA



FIONA



BLITZ +



BLITZ



GRATIA



ADONIS

Contd...

< BACK

www.orientelectric.com

NEXT >

HOME

ABOUT US

PRODUCTS

CONTACT

DECORATIVE FANS



FALCON DECO



FALCON SPEEDSTAR



FALCON 400



SUMMER COOL



SUMMER BREEZE PRO



NEW BREEZE 1 STAR



NEW BREEZE 3 STAR



NEW AIR PLUS



NEW AIR



SMART SAVER 50

HOME

ABOUT US

PRODUCTS

CONTACT

DECORATIVE FANS

MOZART

-  Anti-dust
-  100% copper motor
-  Strong 14 pole motor
-  Rust proof aluminium blades
-  Metallic finish paint
-  5 Years warranty



Sweep (mm)	Air Delivery (CMM)	RPM	Power (w)
1200	220	350	55



Seamless inlay mould design for elegant home decors



Contd...

< BACK

www.orientelectric.com

NEXT >

HOME

ABOUT US

PRODUCTS

CONTACT

DECORATIVE FANS

MOZART



Minimalist Flow White



Nature Floral White

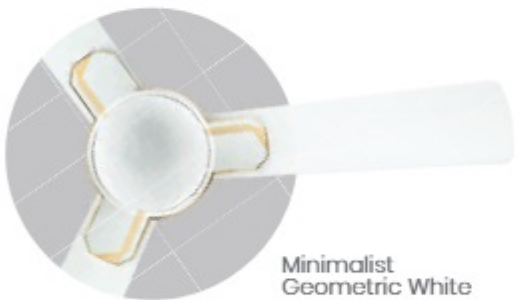

Minimalist Geometric White

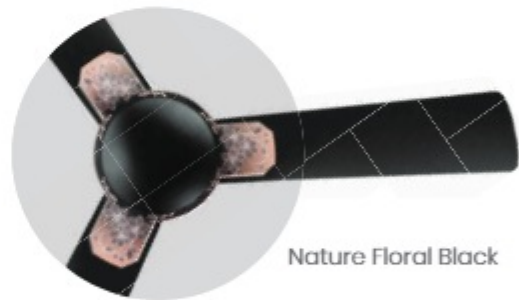

Nature Floral Black

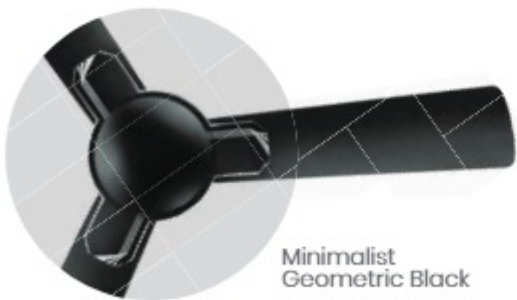

Minimalist Geometric Black



Nature Leaves White

HOME

ABOUT US

PRODUCTS

CONTACT

DECORATIVE FANS

JAZZ

-  Anti-dust*
-  High speed fan
-  Fluidic ring design
-  100% copper motor
-  Strong 14 pole motor
-  Rust proof aluminium blades
-  2 Years warranty



Sweep (mm)	Air Delivery (CMM)	RPM	Power (w)
600	110	850	73
900	155	400	37
1050	165	380	45
1200	215	370	53
1400	250	300	60

*Also available in anti dust variant.
900mm rated BEE 3 star 1050mm rated BEE 2 star, 600, 1200 and 1400mm rated BEE 1 star.



Contd...

< BACK

www.orientelectric.com

NEXT >

HOME

ABOUT US

PRODUCTS

CONTACT

DECORATIVE FANS

JAZZ



Matt White

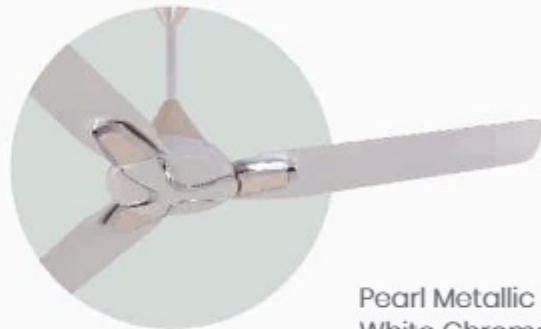

Pearl Metallic
White Chrome



Cosmos Black



Mahogany Brown



Maple Gold

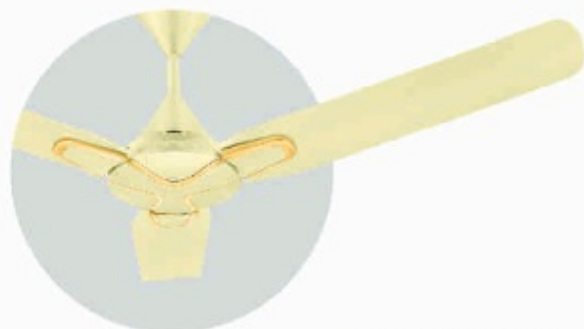

Matt Ivory Gold

HOME





ABOUT US

PRODUCTS

CONTACT

DECORATIVE FANS

JAZZ ART

-  High speed fan
-  Fluidic ring design
-  100% copper motor
-  Strong 14 pole motor
-  Rust proof aluminium blades
-  2 Years warranty



Sweep (mm)	Air Delivery (CMM)	RPM	Power (w)
1200	215	370	53



Seamless inlay mould design for elegant home decors



Contd...

< BACK

www.orientelectric.com

NEXT >

HOME

ABOUT US

PRODUCTS

CONTACT

DECORATIVE FANS

JAZZ ART



Curlin Black



Pearl White
Fire Waves



Topaz Gold
Swing



Jazz Trendz
Metallic Bronze Copper









Grey Arch



Jazz Trendz
Pearl Metallic White

DECORATIVE FANS

WENDY

-  Anti-dust*
-  Unique trim design for elegant home décor
-  Wide blades for high air delivery
-  100% copper motor
-  Strong 16 pole motor
-  Rust proof aluminium blades
-  2 Years warranty

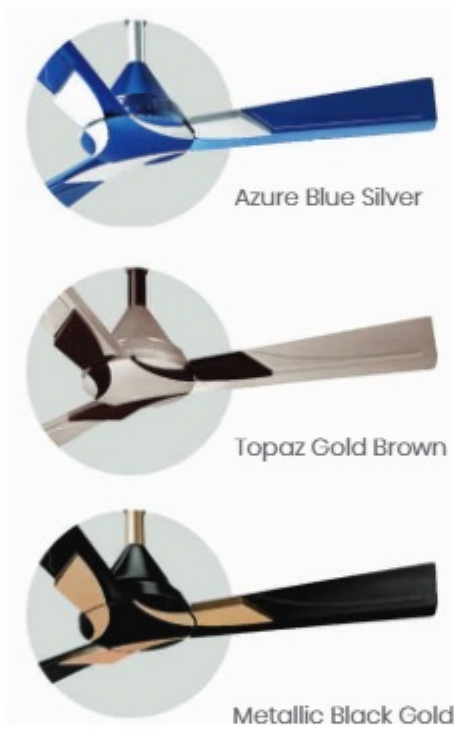

*Also available in anti dust variant.
900mm rated BEE 3 star.
1200mm rated BEE 1 star and 1400mm rated BEE 2 star

Sweep (mm)	Air Delivery (CMM)	RPM	Power (w)
900	155	400	37
1200	230	320	55
1400	250	300	55



HOME

ABOUT US

PRODUCTS

CONTACT

DECORATIVE FANS

BLANCO

-  Anti-dust
-  High speed fan
-  Decorative ring & trim
-  100% copper motor
-  Strong 14 pole motor
-  Rust proof aluminium blades
-  Wide blades for high air delivery
-  2 Years warranty



Sweep (mm)	Air Delivery (CMM)	RPM	Power (w)
1200	220	370	55



DECORATIVE FANS

ARINA

 Wide tipped blades for superior air circulation (225 CMM)

 High speed fan

 Anti-dust for scratch and dust resistance

 Superior matt finish range

 100% copper motor

 Minimalist design to suit your contemporary décor

 2 Years warranty



Matt Space Grey



Matt White



Matt Blue



Coco Brown

Sweep (mm)	Air Delivery (CMM)	RPM	Power (w)
1200	225	370	55



HOME

ABOUT US

PRODUCTS

CONTACT

DECORATIVE FANS

SUBARIS ROYAL

 High air delivery

 Built in timer for 2,4,6 and 8 hours

 Rust proof aluminium blades

 Premium electroplated finish

 Wider sweep size for higher air delivery

 2 Years warranty



Wooden Finish
Antique Copper

Sweep (mm)	Air Delivery (CMM)	RPM	Power (w)
1300	270	250	67

HOME

ABOUT US

PRODUCTS

CONTACT

DECORATIVE FANS

STALLION

 Bold design for modern homes

 4 Blades for high air delivery

 Wider and unique blade design

 Premium electroplated finish

 Strong 16 Pole motor

 2 Years warranty



Pewter Finish



Brushed Brass

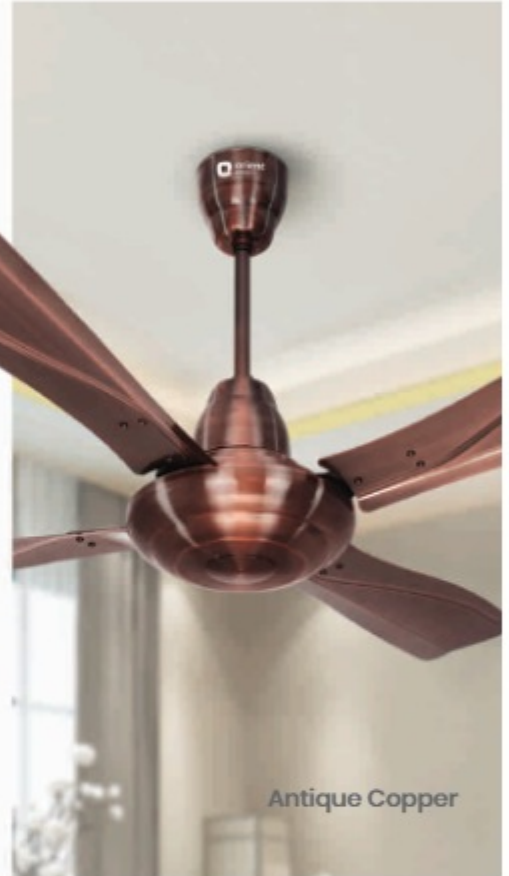





Antique Copper

Sweep (mm)	Air Delivery (CMM)	RPM	Power (w)
1320	250	300	62

DECORATIVE FANS

QUASAR

-  Premium electroplated finish
-  Wide blades for high air delivery
-  100% copper motor
-  Strong 16 pole motor
-  2 Years warranty

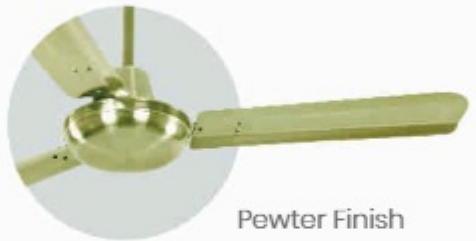

Pewter Finish



Brushed Brass



Brushed Copper

900, 1050, 1200mm rated BEE 2 star and 1400mm rated BEE 1 star

Sweep (mm)	Air Delivery (CMM)	RPM	Power (w)
900	140	400	38
1050	165	380	45
1200	235	320	50
1400	260	300	60



HOME

ABOUT US

PRODUCTS

CONTACT

DECORATIVE FANS

QUADRO ORNAMENTAL

 Dual colour combination adds elegance to your home décor

 Wide blades for high air delivery

 100% copper motor

 Strong 16 pole motor

 Rust proof aluminium blades

 2 Years warranty



Sweep (mm)	Air Delivery (CMM)	RPM	Power (w)
1200	230	320	55



HOME

ABOUT US

PRODUCTS

CONTACT

DECORATIVE FANS

QUASAR ORNAMENTAL

-  Anti-dust*
-  Dual colour combination adds elegance to your home décor
-  Wide blades for high air delivery
-  100% copper motor
-  Strong 16 pole motor
-  Rust proof aluminium blades
-  2 Years warranty



Sea Green

Metallic Ivory Cherry

Silver Blue



Golden Chocolate

Sweep (mm)	Air Delivery (CMM)	RPM	Power (w)
600	110	850	73
900	140	400	38
1050	165	380	45
1200	235	320	50
1400	260	300	60

*Also available in anti dust variant.
900, 1050, 1200 rated BEE 2 star. 1400, 600mm is 1 star.



HOME

ABOUT US

PRODUCTS

CONTACT

DECORATIVE FANS

MORACE

-  High speed fan
-  Anti-dust
-  100% copper motor
-  Strong 14 pole motor
-  Rust proof aluminium blades
-  Metallic finish paint
-  5 Years warranty



Orbes White



Daytone Grey

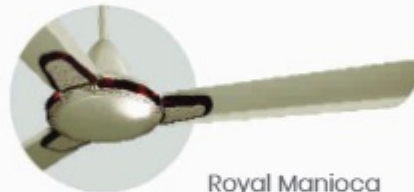

Royal Manioca



Hickory Brown

Sweep (mm)	Air Delivery (CMM)	RPM	Power (w)
1200	215	370	52



Seamless inlay mould design for elegant home decors



HOME

ABOUT US

PRODUCTS

CONTACT

DECORATIVE FANS

KIARA

 High speed fan

 Anti-dust

 100% copper motor

 Strong 14 pole motor

 Rust proof aluminium blades

 Metallic finish paint

 2 Years warranty



Pearl Metallic White



Chocolate Gold



Hickory Brown



Azure Blue

Sweep (mm)	Air Delivery (CMM)	RPM	Power (w)
1200	215	370	53



DECORATIVE FANS

FIONA

 High speed fan

 High air delivery

 Wide tipped blades for superior air circulation

 Strong and durable 100% copper motor (14 pole)

 Rust proof aluminium blades

 Premium metallic finish

 2 Years warranty

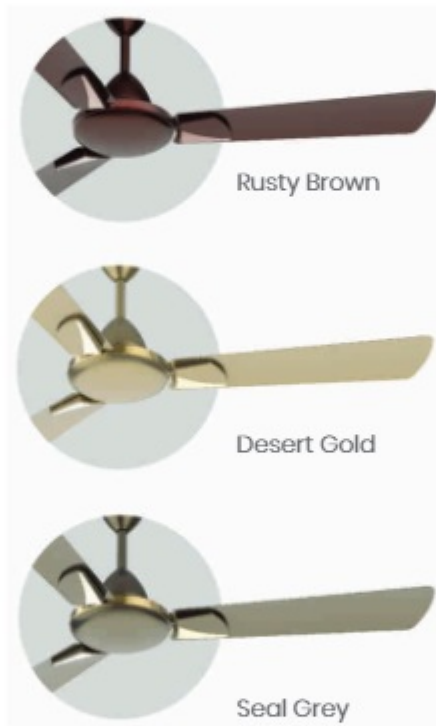

Sweep (mm)	Air Delivery (CMM)	RPM	Power (w)
1200	220	370	54



HOME

ABOUT US

PRODUCTS

CONTACT

DECORATIVE FANS

BLITZ +

 Ultra-high speed fan

 Superior air delivery

 Strong and durable 100% copper motor (14 pole)

 Rust proof aluminium blades

 Premium metallic finish

 2 Years warranty



Royal Beige



Galaxy Brown



Silver Pearl White

Sweep (mm)	Air Delivery (CMM)	RPM	Power (w)
1200	215	380	53



HOME

ABOUT US

PRODUCTS

CONTACT

DECORATIVE FANS

BLITZ

 Superior air delivery

 Strong and durable
100% copper motor
(14 pole)

 Rust proof
aluminium blades

 Double ball bearing for
smooth operations

 2 Years warranty



White

Ivory White

Glossy Brown

Sweep (mm)	Air Delivery (CMM)	RPM	Power (w)
1200	210	350	50



HOME

ABOUT US

PRODUCTS

CONTACT

DECORATIVE FANS

GRATIA

-  Anti-dust
-  Decorative ring and trims to suit contemporary décor
-  High speed fan
-  100% copper motor
-  Strong 14 pole motor
-  Rust proof aluminium blades
-  Wide blades for high air delivery
-  2 Years warranty



Metallic
Bronze Copper

Sweep (mm)	Air Delivery (CMM)	RPM	Power (w)
600	110	850	73
900	140	400	38
1050	165	380	45
1200	215	370	53
1400	255	300	62

*Also available in anti dust variant.
900, 1050mm rated BEE 2 star. 600, 1200 and 1400mm rated BEE 1 star



Contd...

< BACK

www.orientelectric.com

NEXT >

HOME

ABOUT US

PRODUCTS

CONTACT

DECORATIVE FANS

GRATIA



Pearl
Metallic White



Metallic Ivory

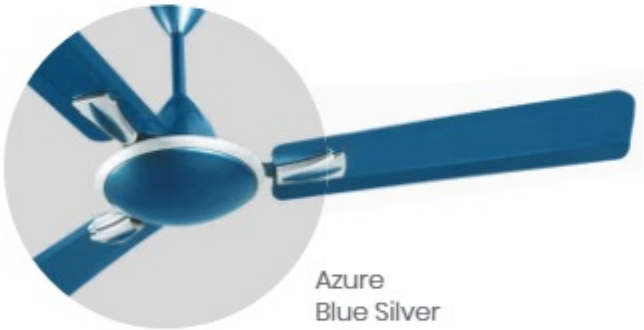

Azure
Blue Silver



Silky Silver



Topaz Gold

HOME

ABOUT US

PRODUCTS

CONTACT

DECORATIVE FANS

ADONIS

-  High speed fan
-  Decorative ring & trim
-  100% copper motor
-  Strong 14 pole motor
-  Rust proof aluminium blades
-  High air delivery
-  2 Years warranty



Aqua Teal

Sweep (mm)	Air Delivery (CMM)	RPM	Power (w)
1200	220	370	53



Contd...

< BACK

www.orientelectric.com

NEXT >

HOME

ABOUT US

PRODUCTS

CONTACT

DECORATIVE FANS

ADONIS

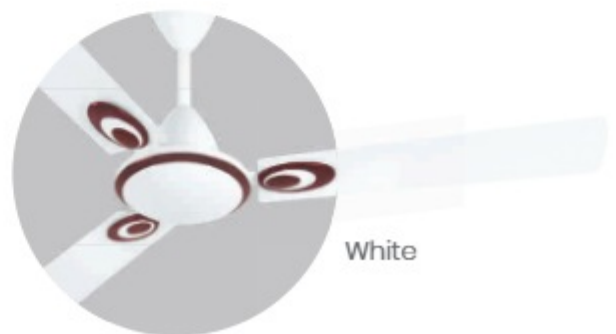
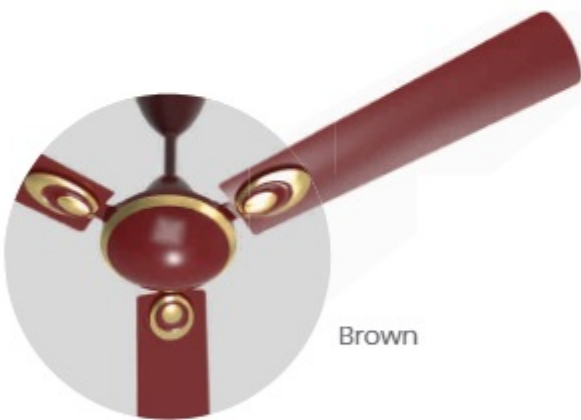
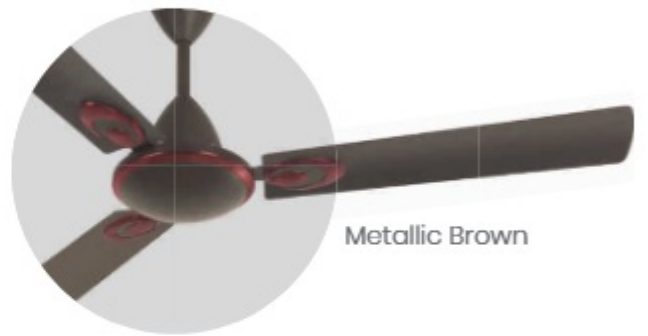
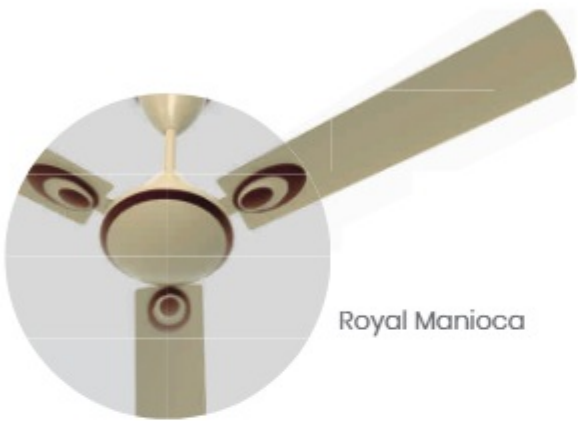

HOME

ABOUT US

PRODUCTS

CONTACT

DECORATIVE FANS

FALCON DECO

-  High speed fan
-  Decorative ring & trim
-  Fastest fan in the category (380 RPM)
-  100% copper motor
-  Strong 14 pole motor
-  Rust proof aluminium blades
-  High air delivery
-  2 Years warranty



Sweep (mm)	Air Delivery (CMM)	RPM	Power (w)
600	110	850	65
900	140	400	38
1200	220	380	55

900mm rated BEE 2 star, 600 and 1200mm rated BEE 1 star.

600, 900mm available in MBC, Daytone Grey and White colour



Contd...

< BACK

www.orientelectric.com

NEXT >

HOME

ABOUT US

PRODUCTS

CONTACT

DECORATIVE FANS

FALCON DECO



White

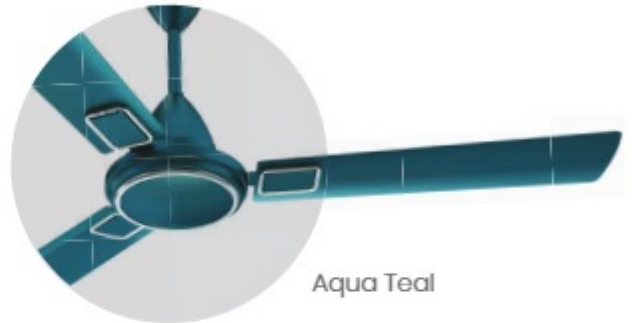

Aqua Teal



Metallic
Bronze Copper

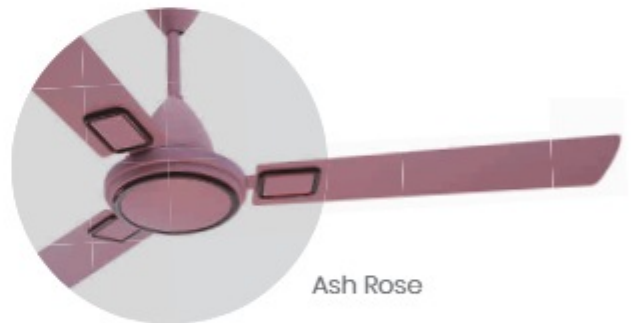

Ash Rose



Brown



Royal Manioca

DECORATIVE FANS

FALCON SPEEDSTAR

 Ultra-high speed fan

 Wide tipped blades for superior air circulation

 High air delivery (230 CMM)

 Strong and durable 100% copper motor (14 pole)

 Rust proof aluminium blades

 5 Years warranty



Sweep (mm)	Air Delivery (CMM)	RPM	Power (w)
1200	230	380	55



DECORATIVE FANS

FALCON 400

 Ultra-high speed fan

 Tangential blades for better aesthetics

 Rust proof aluminium blades

 Strong and durable 100% copper motor (14 pole)

 Durable powder coated finish

 5 Years warranty

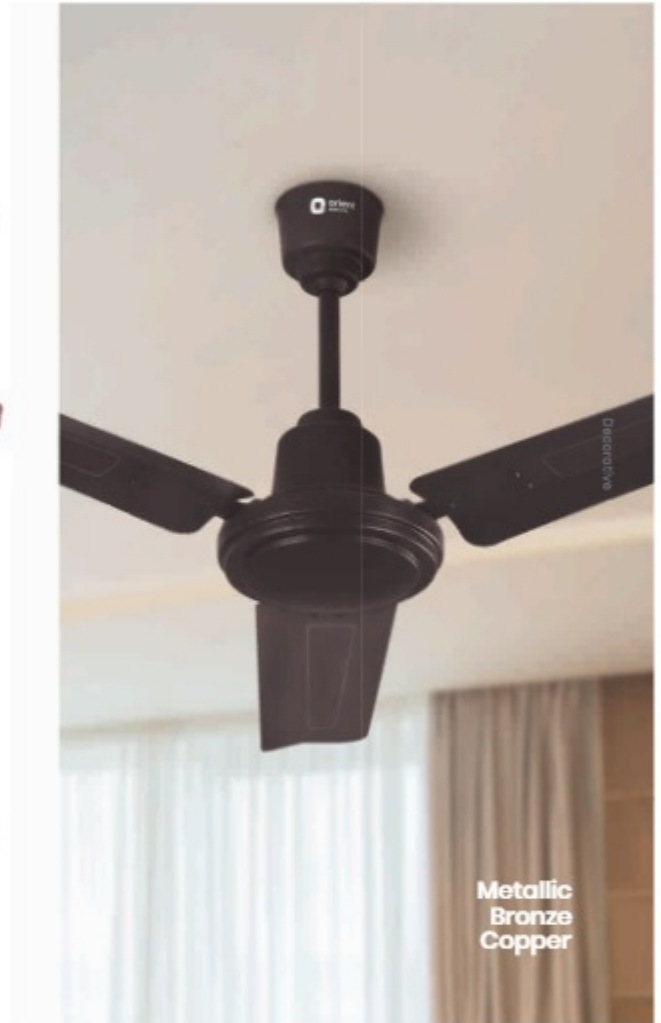

Sweep (mm)	Air Delivery (CMM)	RPM	Power (w)
600	110	850	73
900	140	450	38
1200	215	380	53
1400	245	300	60

600mm available in 4 blade fan.
600, 900, 1200 and 1400mm rated BEE 1 star.



HOME

ABOUT US

PRODUCTS

CONTACT

DECORATIVE FANS

SUMMER COOL

-  Strong and durable 100% copper motor (Best in class 16 pole)
-  Ornamental bottom cover design
-  Rust proof aluminium blades
-  Superior air delivery
-  Consistent performance even at low voltage
-  Durable powder coated Finish
-  5 Years warranty



A fan that has been trusted by over 30 Million+ happy consumers.

Sweep (mm)	Air Delivery (CMM)	RPM	Power (w)
900	140	400	38
1050	165	380	45
1200	220	320	55
1400	225	300	56

00,9050 and 1400mm rated BEE 2-star. 1200mm rated BEE 1-star.



DECORATIVE FANS

SUMMER BREEZE PRO

-  High speed fan
-  Wider tipped blades for superior air circulation
-  Strong and durable 100% copper motor (14 pole)
-  Rust proof aluminium blades
-  Durable powder coated Finish
-  5 Years warranty



900mm rated BEE 2-star.
1200 and 1400mm rated BEE 1-star.

Sweep (mm)	Air Delivery (CMM)	RPM	Power (w)
900	138	400	38
1200	215	370	53
1400	250	300	60



HOME

ABOUT US

PRODUCTS

CONTACT

DECORATIVE FANS

NEW BREEZE 1 STAR

-  Strong and durable 100% copper motor
-  Best-in-class 16 pole motor
-  Rust proof aluminium blades
-  Superior air delivery
-  Consistent performance even at low voltage
-  Durable powder coated finish
-  5 Years warranty



Sweep (mm)	Air Delivery (CMM)	RPM	Power (w)
600	110	850	73
900	140	400	38
1050	165	380	45
1200	220	320	55
1400	255	300	56

600 and 1200mm are BEE 1 star. 900, 1050 and 1400mm are BEE 2 star



< BACK

www.orientelectric.com

NEXT >

DECORATIVE FANS

NEW BREEZE 3 STAR

-  Energy saving with induction (44 W)
-  Strong and durable 100% copper motor (Best-in-class 16 pole)
-  Rust proof aluminium blades
-  Superior air delivery
-  Consistent performance even at low voltage
-  Durable powder coated finish
-  5 Years warranty



Sweep (mm)	Air Delivery (CMM)	RPM	Power (w)
600	110	850	73
900	140	400	38
1050	165	380	45
1200	225	320	44
1400	255	300	56

600mm rated BEE 1-star. 900, 1050 and 1400mm rated BEE 2-star. 1200mm rated BEE 3-star.



HOME

ABOUT US

PRODUCTS

CONTACT

DECORATIVE FANS

NEW AIR PLUS

-  High speed fan
-  Superior air delivery
-  Strong and durable 100% copper motor (14 pole)
-  Rust proof aluminium blades
-  4 blade fan in 600mm
-  2 Years warranty



White

900, 1050 and 1200mm rated BEE 2-star.
1200 and 1400mm rated BEE 1-star.

Sweep (mm)	Air Delivery (cmm)	RPM	Power (w)
600	110	850	73
900	140	400	37
1050	165	380	45
1200	225	370	53
1400	250	300	58



Contd...

< BACK

www.orientelectric.com

NEXT >

HOME

ABOUT US

PRODUCTS

CONTACT

DECORATIVE FANS

NEW AIR PLUS



Brown (600mm)



Brown



White (600mm)



Ivory



Ivory (600mm)

HOME

ABOUT US

PRODUCTS

CONTACT

DECORATIVE FANS

NEW AIR

 High speed fan

 Superior air delivery

 100% copper motor

 Durable powder coated Finish

 2 Years warranty



White



Ivory



Brown

Sweep (mm)	Air Delivery (CMM)	RPM	Power (w)
600	110	850	73

HOME

ABOUT US

PRODUCTS

CONTACT

DECORATIVE FANS

SMART SAVER 50

 Rust proof aluminium blades

 Durable power coated finish

 Strong and durable 100% copper motor

 Durable powder coated Finish

 2 Years warranty



White

Ivory

Brown

Sweep (mm)	Air Delivery (CMM)	RPM	Power (w)
1200	220	350	50



LIFESTYLE FANS

LIFESTYLE FANS
THE BREEZE OF HAPPINESS



Stay cool with Orient's Cloud 3 and its innovative Cloudchill™ technology, transforming water droplets into nanoparticles for a refreshing breeze. Available in sleek Black & White designs, its space-saving features include a sturdy base and castor wheels for easy mobility. Control it effortlessly with the ergonomic remote for ultimate convenience. Beat the heat in style and comfort with Orient's Cloud 3, your go-to cooling solution for summers to come.

PRODUCTS



HOME

ABOUT US

PRODUCTS

CONTACT

LIFESTYLE FANS



ORIENT CLOUD 3



BLADELESS



PROTEUS

LIFESTYLE FANS

AVAILABLE IN
BLACK
AND WHITE



Breeze mode

Experience the pleasant sensation of fresh and pure breeze inside your home with the fan's breeze mode



Enhanced air circulation

with unique guard design. The elegant grill design ensures safety and helps in effective circulation of air to enhance the overall cooling experience



HOME

ABOUT US

PRODUCTS

CONTACT

LIFESTYLE FANS



Tilt mechanism
Adjustable downward tilt
up to 10-degrees helps
direct the cooling where
you want it



Beat the heat
with the revolutionary
Cloudchill technology
that drops air
temperature
significantly. Amplify the
coolness by adding ice for
a refreshing experience.



HOME

ABOUT US

PRODUCTS

CONTACT

LIFESTYLE FANS



30-degree oscillation
Unique 30-degree oscillation with gliding top mechanism helps circulate cool air across the room, enhancing your comfort



Fragrance chamber
Add fragrance of your choice in the easy-fill inlet to lift your mood



Lifestyle

HOME









ABOUT US

PRODUCTS

CONTACT

LIFESTYLE FANS

BLADELESS

-  Silent operation
-  Strong & reliable motor
-  Built-in timer
-  Remote
-  Power saving
-  Swing
-  Breeze modes
-  Easy to clean

Voltage : 220-240V
Frequency : 50/60 Hz
Power : 40W



HOME





ABOUT US

PRODUCTS

CONTACT

LIFESTYLE FANS

PROTEUS

-  Silent operation
-  Strong & reliable motor
-  1 Hour timer
-  Power saving
-  Rotating grill



Voltage : 220-240V

Frequency : 50 Hz

Power : 42W

[HOME](#)[ABOUT US](#)[PRODUCTS](#)[CONTACT](#)

TABLE, PEDESTAL & WALL FANS



WHY SHOULD CEILINGS HAVE ALL THE FUN!

SPREADING SMILES, ONE FAN AT A TIME

The diverse collection of Table, Pedestal, and Wall fans is designed keeping your comfort in mind. Offering you top-notch quality with an easy-to-use interface, these fans are made to deliver nothing but excellence, and of course lots of air!

[PRODUCTS](#)

HOME

ABOUT US

PRODUCTS

CONTACT

TABLE, PEDESTAL & WALL FANS



TABLE



PEDESTAL



WALL

HOME

ABOUT US

PRODUCTS

CONTACT

TABLE FANS



RETRO SERIES



DESK 71



ZIPPY PRO



TABLE 27 NEO



WIND-PRO



DESK 25



DESK 26



TABLE 27



DESK 17

TABLE FANS

RETRO SERIES

-  90-degree oscillation
-  High speed motor gives high air thrust at 2100 RPM
-  Rubbed-bronze finish adds to the overall aesthetics
-  3-Speed rotary switch control
-  Spiral guard design ensure international safety standard
-  Up & down tilt mechanism
-  Motor protection through thermal overload protection device
-  2 Years warranty



T12
Rubbed Bronze



T16 HS
Rubbed Bronze



T16 Rubbed Bronze

Models	Sweep (mm)	Air Delivery (CMM)	RPM
Retro T12	300	47	2100
Retro 16HS	400	85	2100
Retro 16	400	80	1300

HOME

ABOUT US

PRODUCTS

CONTACT

TABLE FANS

DESK 71

↑ ↓ Up & down tilt mechanism

90-degree oscillation

3-Speed piano switch control

Extra protection against corrosion with powder-coated guard and polymer ring

Motor protection with thermal overload protection

Aerodynamically designed resin blades for maximum air delivery

2 Years warranty

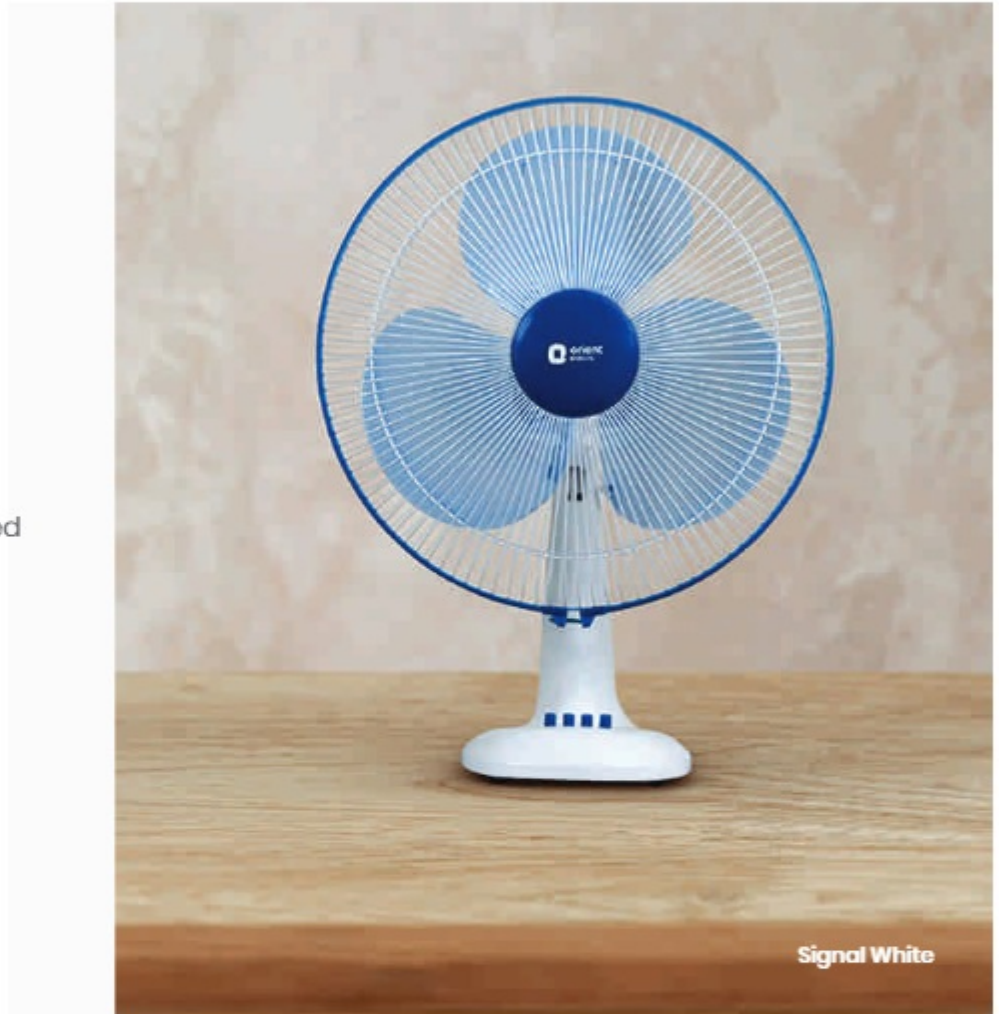

Sweep (mm)	Air Delivery (CMM)	RPM
400	90	1330

TABLE FANS

ZIPPY PRO



Aerodynamically designed resin blades ensure high thrust of air



Motor protection with thermal overload protection and auto-resetting



Attractive colour combination



Heavy-duty motor with 2500 RPM provides high air thrust



2-in-1 advantage of wall mounting & table-top usage



2 Years warranty



White

Black Red

Black

White Grey

Sweep (mm)	Air Delivery (CMM)	RPM
225	35	2500

TABLE FANS

TABLE 27 NEO

↑ ↓ Up & down tilt mechanism

▮▮▮ 3-Speed piano switch control

🌀 Aerodynamically designed resin blades for high air delivery

⚙️ Motor protection with thermal overload protection and auto-resetting

🛡️ Extra protection against corrosion with powder-coated guard and polymer ring

🛡️ 2 Years warranty



Black



White



Black Red

Sweep (mm)	Air Delivery (CMM)	RPM
400	100	2100

TABLE FANS

WIND-PRO

-  Thermal overload protection device
-  Elegant aesthetic with 5-leaf blades
-  Extra-high air thrust with heavenly silent motor
-  Oscillation & speed control
-  High air delivery at moderate power consumption
-  2 Years warranty



Sweep (mm)	Air Delivery (CMM)	RPM
400	100	1350

Motor with revolutionary



For smoother, longer and reliable operations.

TABLE FANS

DESK 25

↑ ↓ Up & down tilt mechanism

Easy snap-fit assembly

Motor protection with thermal overload protection and auto-resetting

3-Speed piano switch control

Aerodynamically designed resin blades for maximum air delivery

Extra protection against corrosion with powder-coated guard and polymer ring

90-degree oscillation

2 Years warranty



Azure Blue-White



Signal White



Black

Sweep (mm)	Air Delivery (CMM)	RPM
400	75	1330

Motor with revolutionary



For smoother, longer and reliable operations.

TABLE FANS

DESK 26

↑ ↓ Up & down tilt mechanism

Easy snap-fit assembly

Aerodynamically designed resin blades for maximum air delivery

3-Speed piano switch control

Motor protection with thermal overload protection and auto-resetting

Extra protection against corrosion with powder-coated guard and a polymer ring

90-degree oscillation

2 Years warranty



Crimson Red white



Crystal White



Azure Blue white

Sweep (mm)	Air Delivery (CMM)	RPM
400	90	1330

Motor with revolutionary



For smoother, longer and reliable operations.

TABLE FANS

TABLE 27

↑ ↓ Up & down tilt mechanism

▮▮▮ 3-speed piano switch control

🌀 Aerodynamically designed resin blades for maximum air delivery

⊙ 2100 RPM For high air thrust

⚙️ Motor protection with thermal overload protection and auto resetting

🛡️ Extra protection against corrosion with powder-coated guard and polymer ring

🚀 High speed

🛡️ 2 Years warranty



Sweep (mm)	Air Delivery (CMM)	RPM
400	100	2100

HOME





ABOUT US

PRODUCTS

CONTACT

TABLE FANS

DESK 17

-  3-Speed rotary switch control
-  Up & down index tilt mechanism
-  Extra protection against corrosion with powder-coated guard and polymer ring
-  90-degree oscillation
-  Ideal for small cabins, offices & homes
-  Aerodynamically designed resin blades for maximum air delivery
-  2100 RPM For high air thrust
-  Motor protection with thermal overload protection and auto-resetting
-  2 Years warranty

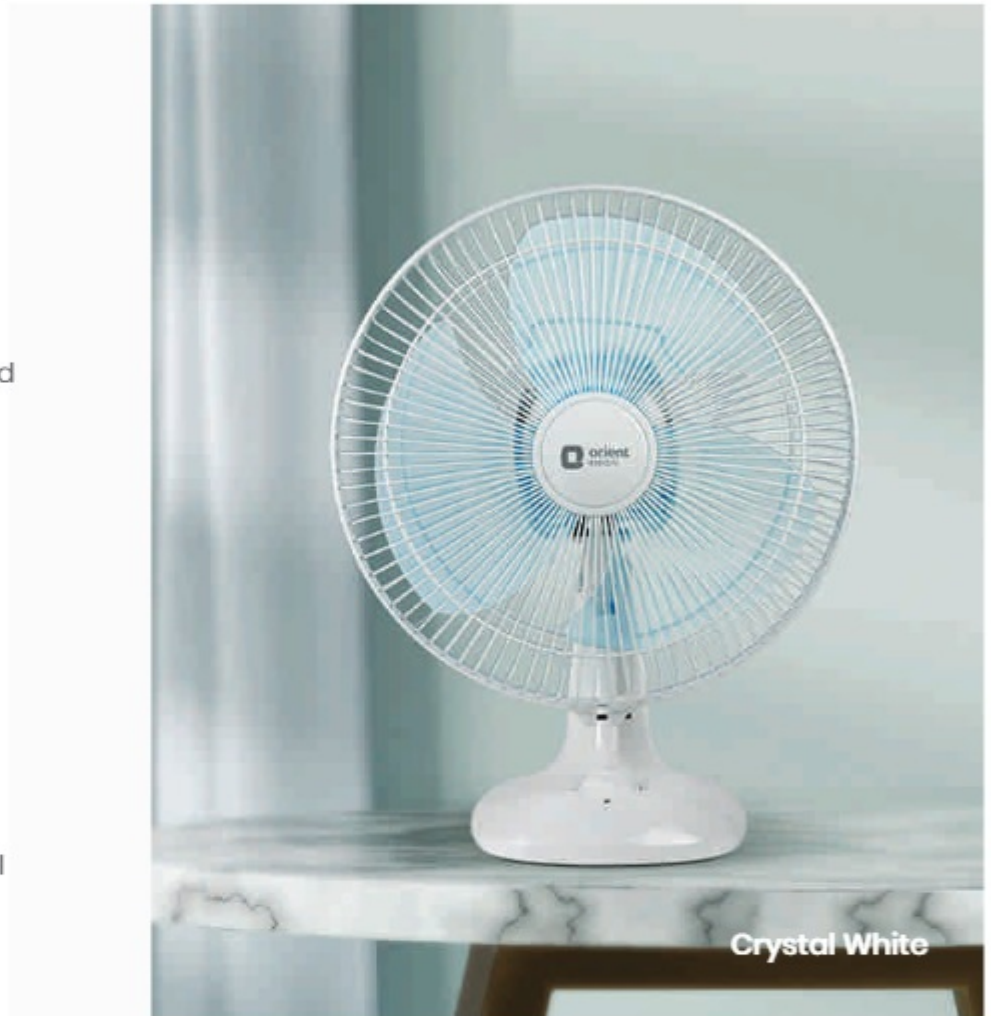

Crystal White

Sweep (mm)	Air Delivery (CMM)	RPM
300	80	2100

HOME

ABOUT US

PRODUCTS

CONTACT

PEDESTAL FANS



STAND 37



STAND 35



STAND 32



STYLUS



STAND 37 NEO



TORNADO-II

Contd...

HOME

ABOUT US

PRODUCTS

CONTACT

PEDESTAL FANS



FARATA FT-01



STAND 33



STAND 31













STAND 35HS



STAND 38

PEDESTAL FANS

STAND 37

-  Up & down tilt mechanism
-  3-Speed piano switch control
-  Telescopic arrangement for full height adjustment by contemporary collet
-  90-degree oscillation
-  Aerodynamically designed resin blades for high air delivery
-  2100 RPM For high air thrust
-  Motor protection with thermal overload protection and auto-resetting
-  Extra protection against corrosion with powder-coate guard and polymer ring
-  High speed
-  2 Years warranty



Signal White

Sweep (mm)	Air Delivery (CMM)	RPM
400	100	2100

HOME



ABOUT US

PRODUCTS

CONTACT

PEDESTAL FANS

STAND 35

-  Sleek 4-leaf aluminium blade classic design
-  Attractive rubbed-bronze finish
-  Powerful motor for high air delivery
-  Extra protection against corrosion with powder-coated guard and metal ring
-  2 Years warranty



Rubbed Bronze

Sweep (mm)	Air Delivery (CMM)	RPM
400	80	1300

PEDESTAL FANS

STAND 32

↑ ↓ Up & down tilt mechanism

Telescopic arrangement for full height adjustment by contemporary collet

Aerodynamically designed resin blades for high air delivery

90-degree oscillation

Square base finish adds to the overall aesthetics

Extra protection against corrosion with powder-coated guard and polymer ring

3-Speed piano switch control

Motor protection with thermal overload protection device

2 Years warranty



Sweep (mm)	Air Delivery (CMM)	RPM
400	75	1330

Motor with revolutionary



For smoother, longer and reliable operations.

HOME

ABOUT US

PRODUCTS

CONTACT

PEDESTAL FANS

STYLUS



Manual and remote control



Breeze mode and timer for auto switch off



High air delivery at moderate power consumption



Unique square guard with radial wires



Unique combination of motor and blade for more air thrust



Thermal overload protection device



90-degree oscillation with remote control



2 Years warranty



Sweep (mm)	Air Delivery (CMM)	RPM
400	100	1350

Motor with revolutionary



For smoother, longer and reliable operations.

PEDESTAL FANS

STAND 37 NEO

↑ ↓ Up & down tilt mechanism

90-degree oscillation

Motor protection with thermal overload protection and auto-resetting

Aerodynamically designed resin blades for high air delivery

3-Speed piano switch control

Extra protection against corrosion with powder-coated guard and polymer ring

2 Years warranty

High speed



Signal White

Black



Black & Red

Sweep (mm)	Air Delivery (CMM)	RPM
400	100	2100

PEDESTAL FANS

TORNADO-II

-  Powerful motor for high air delivery
-  Unique oil reservoir lubrication for better reliability & longer life
-  Unique oscillation mechanism
-  Unit packing with easy assembly
-  Extra protection against corrosion with powder-coated guard and polymer ring
-  3-speed regulation & On/Off control
-  Thermal overload protection with auto-reset
-  Aerodynamic metal blades for high air thrust
-  **2** 2 Years warranty



Sweep (mm)	Air Delivery (CMM)	RPM
450	110	1325

ALL METAL CONSTRUCTION

HOME

ABOUT US

PRODUCTS

CONTACT

PEDESTAL FANS

FARATA FT-01



Balanced operation & powder-coated finish ensure longer life



3-Speed rotary switch control



Heavy-duty motor & aerodynamic blades give high air thrust at minimum noise



2 Years warranty



Sweep (mm)	Air Delivery (CMM)	RPM
500	167	1400

PEDESTAL FANS

STAND 33

↑ ↓ Up & down tilt mechanism

 Powerful motor for high air delivery

 Motor protection with thermal overload protection device

 90-degree oscillation

 Aerodynamically designed resin blades ensure high thrust of air

 Extra protection against corrosion with powder-coated guard and polymer ring

 3-Speed piano switch control

 2 Years warranty

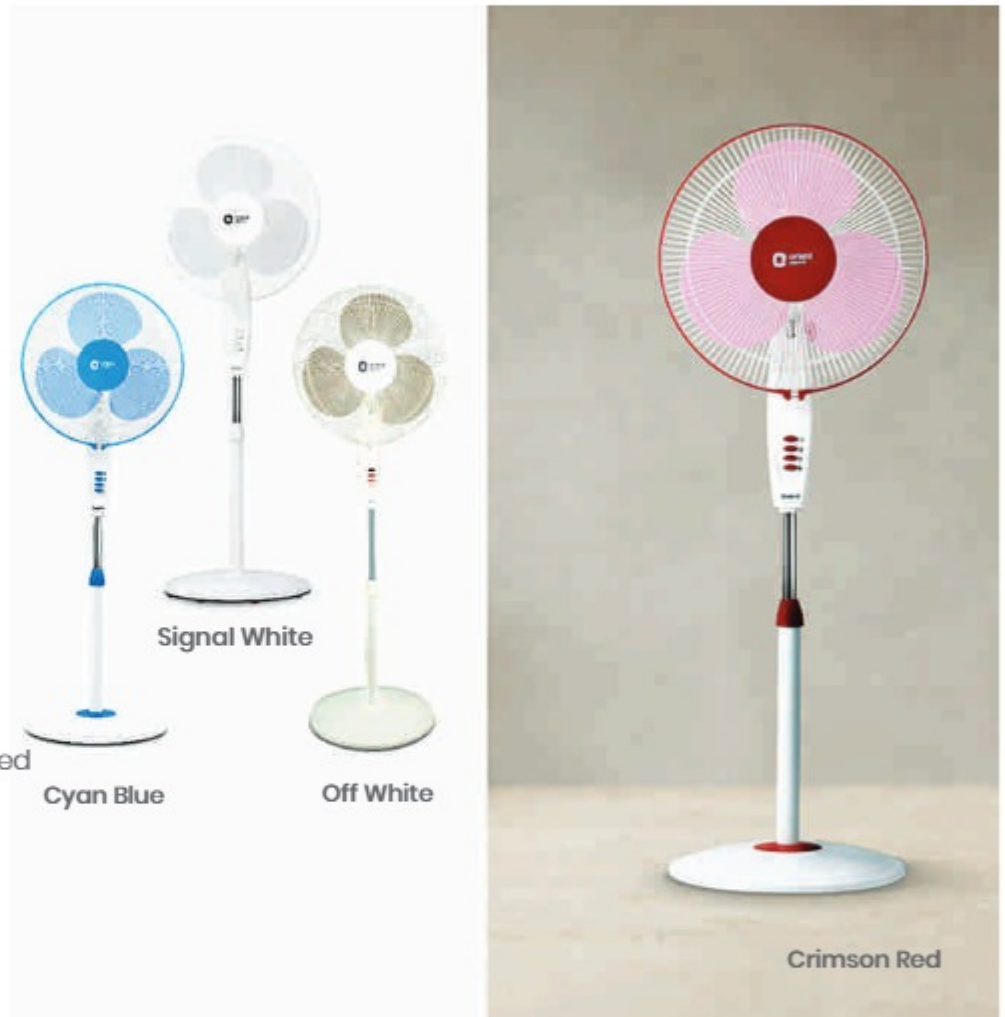

Sweep (mm)	Air Delivery (CMM)	RPM
400	90	1330

Motor with revolutionary



For smoother, longer and reliable operations.

PEDESTAL FANS

STAND 31

↑ ↓ Up & down tilt mechanism

🌐 Cross-steel base adds elegance to the decor

⚙️ Motor protection with thermal overload protection device

🎹 3-Speed piano switch control

🌀 Aerodynamically designed resin blades for high air delivery

🔄 90-degree oscillation

🛡️ Extra protection against corrosion with powder-coated guard and polymer ring

🛡️ 2 Years warranty



Sweep (mm)	Air Delivery (CMM)	RPM
400	90	1330

Motor with revolutionary



For smoother, longer and reliable operations.

PEDESTAL FANS

STAND 35HS

-  Sleek 4-leaf aluminium blade classic design
-  Attractive rubbed-bronze finish
-  Powerful motor for high air delivery
-  Extra protection against corrosion with powder-coated guard and metal ring
-  High speed motor of 2100 RPM
-  2 Years warranty



Rubbed Bronze

Sweep (mm)	Air Delivery (CMM)	RPM
400	85	2100

Motor with revolutionary



For smoother, longer and reliable operations.

PEDESTAL FANS

STAND 38

-  Up & down tilt mechanism
-  Extra protection against corrosion with powder-coated guard and polymer ring
-  Motor protection with thermal overload protection device
-  90-degree oscillation
-  Aerodynamically designed resin blades give high air thrust
-  Front & back guard with extra ribs for safety
-  Powerful motor for high air delivery
-  Sleek switch panel & round base add elegance to the decor
-  2 Years warranty



Sweep (mm)	Air Delivery (CMM)	RPM
450	92	1330

Motor with revolutionary



For smoother, longer and reliable operations.

HOME

ABOUT US

PRODUCTS

CONTACT

WALL FANS



STYLUS



WALL 48



WALL 14



WALL 11



WALL 43



WALL 44 TRENDZ



WALL 47 TRENDZ



TORNADO WALL-II



WALL 49

Contd...

HOME

ABOUT US

PRODUCTS

CONTACT

WALL FANS



WALL 41



WALL 44



WALL 47



ROTO-53

WALL FANS

STYLUS

-  Manual and remote control
-  Breeze mode and timer for auto switch off
-  High air delivery at moderate power consumption
-  Unique square guard with radial wires
-  Unique combination of motor and blade for more air thrust
-  Thermal overload protection device
-  Super-efficient and silent motor
-  90-degree oscillation with remote control
-  2 Years warranty



Sweep (mm)	Air Delivery (CMM)	RPM
400	100	1350

Motor with revolutionary



For smoother, longer and reliable operations.

WALL FANS

WALL 48

-  90-degree oscillation
-  Front & back guard with extra ribs for safety
-  Extra protection against corrosion with powder-coated guard and polymer ring
-  Up & down tilt mechanism
-  Oscillation & speed control by pull-cord mechanism
-  Aerodynamically designed resin blades for maximum air delivery
-  Super-efficient and silent motor
-  Motor protection with thermal overload protection and auto-resetting
-  2 Years warranty



Crystal White

Sweep (mm)	Air Delivery (CMM)	RPM
450	92	1330

Motor with revolutionary



For smoother, longer and reliable operations.

WALL FANS

WALL 14

↑
↓
Up & down
tilt mechanism

Motor protection with
thermal overload protection
and auto-resetting

Aerodynamically designed
resin blades for maximum
air delivery

Oscillation & speed control
by pull cord mechanism

Specially designed
motor gives high air
thrust @ 2100 RPM

Extra protection against
corrosion with powder-coated
guard and polymer ring

2
2 Years warranty



Crystal White

Sweep (mm)	Air Delivery (CMM)	RPM
300	80	2100

WALL FANS

WALL 11

↑ ↓ Up & down tilt mechanism

 Powerful motor for high air delivery

 Aerodynamic resin blades for high air thrust

 90-degree oscillation

 Oscillation & speed control by pull-cord mechanism

 Motor protection with thermal overload protection

 2 Years warranty



Crystal White

Sweep (mm)	Air Delivery (CMM)	RPM
300	50	1400









Motor with revolutionary

CT@TECH

For smoother, longer and reliable operations.

WALL FANS

WALL 43

-  Up & down tilt mechanism
-  Powerful motor for high air delivery
-  Aerodynamic resin blades for high air thrust
-  Oscillation & speed control by pull-cord mechanism
-  Motor protected with thermal overload protection
-  90-degree oscillation
-  Extra protection with powder-coated guard and polymer ring
-  2 Years warranty



Sweep (mm)	Air Delivery (CMM)	RPM
400	90	1330

Motor with revolutionary



For smoother, longer and reliable operations.

WALL FANS

WALL 44

Trendz

-  Up & down tilt mechanism
-  Powerful motor for high air delivery
-  Motor protection with thermal overload protection device
-  90-degree oscillation
-  Aerodynamic resin blades for high air thrust
-  Extra protection with powder-coated guard and polymer ring
-  3-Speed rotary switch control
-  2 Years warranty



Sweep (mm)	Air Delivery (CMM)	RPM
400	90	1330









Motor with revolutionary



For smoother, longer and reliable operations.

WALL FANS

WALL 47 *Trendz*

-  Up & down tilt mechanism
-  Specially designed motor gives high air thrust @ 2100 RPM
-  Oscillation & speed control by pull cord mechanism
-  90-degree oscillation
-  Extra protection with powder-coated guard and polymer ring
-  Aerodynamic resin blades for high air thrust
-  Motor protection with thermal overload protection device
-  High speed



Sweep (mm)	Air Delivery (CMM)	RPM
400	100	2100

WALL FANS

TORNADO WALL-II

 Extra protection against corrosion with powder-coated guard and polymer ring

 Up & down tilt mechanism

 Aerodynamic metal blades for high air thrust

 Pull-cord mechanism for on/off & speed control

 Powerful motor for high air delivery

 Thermal overload protection with auto-reset

 Unique oil reservoir lubrication for better reliability & longer life



Gunmetal



Black



Chrome

Sweep (mm)	Air Delivery (CMM)	RPM
450	110	1325

WALL FANS

WALL 49

-  Up & down tilt mechanism
-  Extra protection with powder-coated guard and polymer ring
-  Automatic speed control through the breeze control button
-  Aerodynamic blades for high air thrust
-  Motor protection with thermal overload protection device
-  Advanced touch-screen panel for manual operation
-  Breeze mode and timer for auto switch off

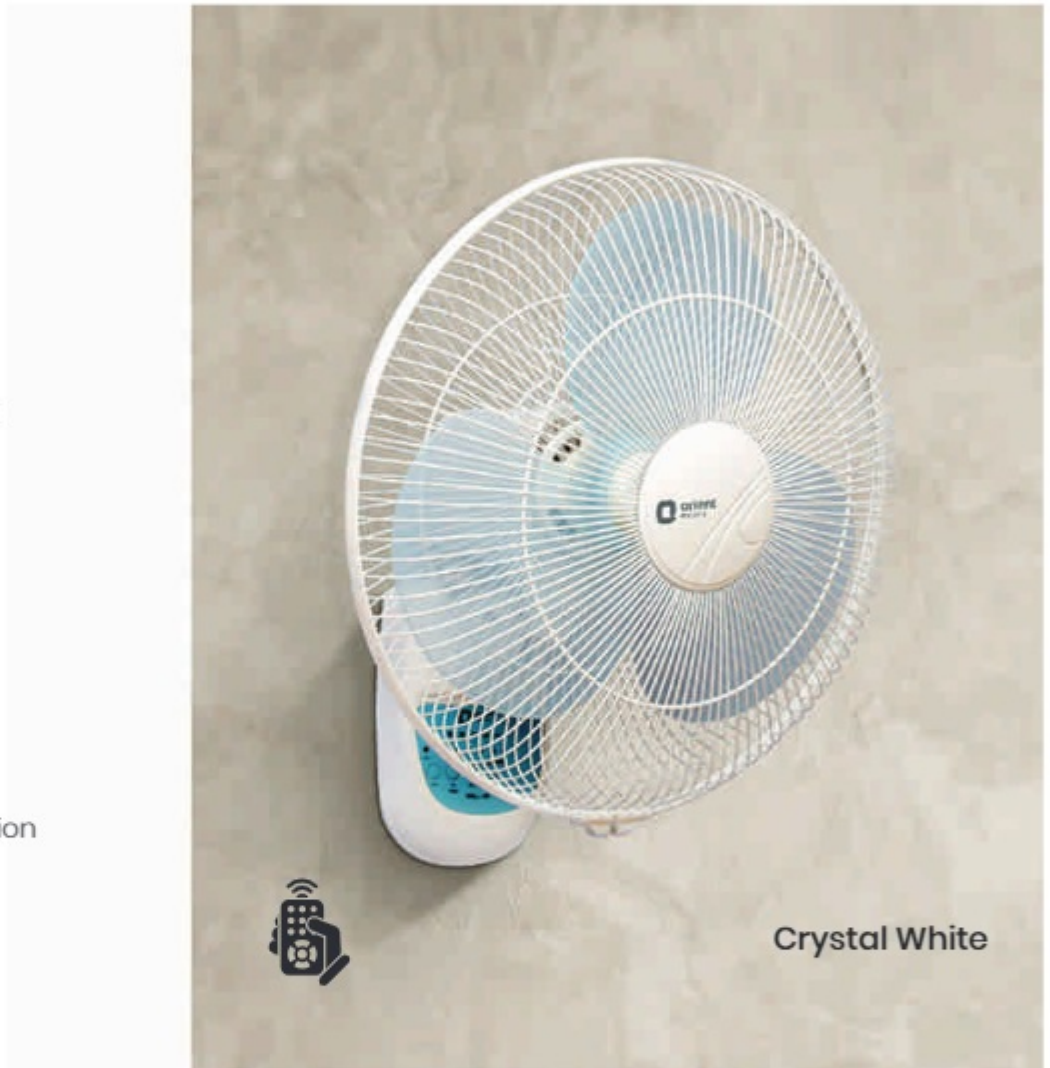

Crystal White

Sweep (mm)	Air Delivery (CMM)	RPM
400	90	1330

Motor with revolutionary



For smoother, longer and reliable operations.

HOME

ABOUT US

PRODUCTS

CONTACT

WALL FANS

WALL 41

-  90-degree oscillation
-  Powerful motor for high air delivery
-  Extra protection with powder-coated guard and polymer ring
-  Up & down tilt mechanism
-  Motor protected with thermal overload protection device
-  3-Speed piano switch control



Sweep (mm)	Air Delivery (CMM)	RPM
400	90	1330

WALL FANS

WALL 44

↑ ↓ Up & down tilt mechanism

 Aerodynamic resin blades for high air thrust

 90-degree oscillation

 Extra protection against corrosion with powder-coated guard and polymer ring

 Powerful motor for high air delivery

 Motor protected with thermal overload protection device

 2 Years warranty



Sweep (mm)	Air Delivery (CMM)	RPM
400	75	1330









Motor with revolutionary



For smoother, longer and reliable operations.

WALL FANS

WALL 47

-  Up & down tilt mechanism
-  Motor protection with thermal overload protection and auto-resetting
-  Aerodynamically designed resin blades for maximum air delivery
-  90-degree oscillation
-  Oscillation & speed control by pull cord mechanism
-  Specially designed motor gives high air thrust @ 2100 RPM
-  Extra protection against corrosion with powder-coated guard and polymer ring
-  High speed
-  2 Years warranty



Sweep (mm)	Air Delivery (CMM)	RPM
400	100	2100

HOME

ABOUT US

PRODUCTS

CONTACT

WALL FANS

ROTO-53

 Wall mounting regulator

 360-degree cyclic motion

 Powerful motor for high air delivery

 Extra protection against corrosion with powder-coat guard and polymer ring

 2 Years warranty



Sweep (mm)	Air Delivery (CMM)	RPM
400	90	1330

EXHAUST FANS



Orient's Exhaust fans are carefully crafted to offer not just cleaner air and dust-free surroundings but also unparalleled performance, all wrapped in an elegant design that seamlessly complements your decor and enhances the ambiance. With Orient Exhaust Fans, bid farewell to noise disruptions and unpleasant odors, as they are engineered to create a tranquil and fresh environment in your surroundings.

EXHAUST FANS

ADD JOY TO YOUR
CULINARY JOURNEY

PRODUCTS

HOME

ABOUT US

PRODUCTS

CONTACT

EXHAUST FANS



SMART AIR NEO SF



VENTILATOR HS



VENTILATOR DX



SMART AIR LSH



SMART AIR NEO



SMART AIR



VENITO AIR



HIGH SPEED EXHAUST



HILL AIR

Contd...

HOME

ABOUT US

PRODUCTS

CONTACT

EXHAUST FANS



AIR FLOW



SPRING AIR



POWER FLOW



POWER FLOW

HOME

ABOUT US

PRODUCTS

CONTACT

EXHAUST FANS

SMART AIR NEO SF

 Strong powerful motor

 Glass mountable

 Easy to clean

 Powerful air suction

 Ideal for kitchens & bathrooms

 High speed

Sweep (mm)	Air Delivery (CMH)	RPM
150	220	2000



Sliver Finish

HOME

ABOUT US

PRODUCTS

CONTACT

EXHAUST FANS

VENTILATOR HS

-  Smooth & silent operation
-  Dust protection shutter
-  Sleek & trendy design
-  High speed
-  2 Years warranty

Sweep (mm)	Air Delivery (CMH)	RPM
150	500	2500
200	750	2100



HOME

ABOUT US

PRODUCTS

CONTACT

EXHAUST FANS

VENTILATOR DX

 Resin body & blades for easy maintenance

 Shutter to prevent dust from outside

 International design

 2 Years warranty

Sweep (mm)	Air Delivery (CMH)	RPM
150	280	1350
200	550	1300
250	780	1270



HOME

ABOUT US

PRODUCTS

CONTACT

EXHAUST FANS

SMART AIR LSH

 Strong powerful motor

 Glass mountable

 Easy to clean

 Powerful air suction

 Ideal for kitchens & bathrooms

 High speed

Sweep (mm)	Air Delivery (CMH)	RPM
150	230	2000



HOME







ABOUT US

PRODUCTS

CONTACT

EXHAUST FANS

SMART AIR NEO

-  Strong powerful motor
-  Glass mountable
-  Easy to clean
-  Powerful air suction
-  Ideal for kitchens & bathrooms
-  High speed

Sweep (mm)	Air Delivery (CMH)	RPM
100	90	2500
150	220	2000



EXHAUST FANS

SMART AIR

 Stylish, compact fan with super efficient motor

 Sturdy front grill for additional safety



Sweep (mm)	Air Delivery (CMH)	RPM
100	90	2500
150	250	2000

HOME

ABOUT US

PRODUCTS

CONTACT

EXHAUST FANS

VENITO AIR

 Strong powerful motor

 Glass Mountable

 Easy to clean

 Powerful air suction

 Ideal for kitchens & bathrooms

 Elegant design

 High speed



Sweep (mm)	Air Delivery (CMH)	RPM
150	280	2000

HOME

ABOUT US

PRODUCTS

CONTACT

EXHAUST FANS

HIGH SPEED EXHAUST



Front guard protection for birds



Powerful air suction



Ideal for kitchens & bathrooms



Powder-coated for long life



Sweep (mm)	Air Delivery (CMH)	RPM
230	1150	2500

HOME

ABOUT US

PRODUCTS

CONTACT

EXHAUST FANS

HILL AIR



Front guard protection
for bird



Powder-coated
for long life



Ideal for kitchens
& bathrooms



Sweep (mm)	Air Delivery (CMH)	RPM
230	550	1350
300	1290	1300

HOME

ABOUT US

PRODUCTS

CONTACT

EXHAUST FANS

AIR FLOW

 Powder-coated for long life

 Resin blades for easy cleaning

 Front guard protection for birds

Sweep (mm)	Air Delivery (CMH)	RPM
150	400	2800
230	550	1350
300	1290	1320



HOME

ABOUT US

PRODUCTS

CONTACT

EXHAUST FANS

SPRING AIR

 Powder-coated
for long life

 Resin blades for
easy cleaning

Sweep (mm)	Air Delivery (CMH)	RPM
230	650	1320
300	1290	1300



HOME

ABOUT US

PRODUCTS

CONTACT

EXHAUST FANS

POWER FLOW HS



Powerful air
suction



Powder-coated
for long life



Ideal for kitchens
& bathrooms



Front guard protection
for birds



Sweep (mm)	Air Delivery (CMH)	RPM
150	500	2650

HOME

ABOUT US

PRODUCTS

CONTACT

EXHAUST FANS

POWER FLOW



Powerful air suction



Powder-coated for long life



Ideal for kitchens & bathrooms



Double ball-bearing



Sweep (mm)	Air Delivery (CMH)	RPM
230	865	1350
300	1800	1320

INDUSTRIAL FANS



INDUSTRIAL FANS

DURABLE FANS FOR ALL YOUR INDUSTRIAL NEEDS

Industrial fans by Orient are powerful and sturdy. Built with a heavy-duty motor, these are durable, perfectly compatible with any industrial use, and are super-efficient in circulating air even in large and expansive spaces.

PRODUCTS



HOME

ABOUT US

PRODUCTS

CONTACT

INDUSTRIAL FANS



THUNDERSTORM
PRO WALL FAN



THUNDERSTORM
PRO STAND FAN



THUNDERSTORM
PRO WALL FAN



THUNDERSTORM
PRO WALL FAN



WALL AC-18



STAND AC-18



WALL AC-24











STAND AC-24



HEAVY DUTY EXHAUST

INDUSTRIAL FANS

THUNDERSTORM PRO WALL FAN









-  Double ball-bearing
-  Powerful air circulating motor for continuous operation with high air delivery & thrust
-  It comes with the air direction control by telescopic height adjustment
-  Sturdy metallic body for "durability"
-  Motor protection and thermal overload protection device with auto-reset
-  Narrow aerodynamically designed blades for providing "Low Noise"
-  Tilt adjustment for adjusting the fan till 15° angle
-  Floating arrangement for changing the position of oscillation



Sweep Model	Sweep (mm)	RPM	Phase	Power Input (Watt)	Current (AMP)	Air Delivery (CMH)	Noise Level (DB)
450 mm AC(Wall)	450	1400	1	100	0.45	8000	60 - 65

INDUSTRIAL FANS

THUNDERSTORM PRO STAND FAN

-  Double ball-bearing
-  Powerful air circulating motor for continuous operation with high air delivery & thrust
-  It comes with the air direction control by telescopic height adjustment
-  Sturdy metallic body for "durability"
-  Motor protection and thermal overload protection device with auto-reset
-  Narrow aerodynamically designed blades for providing "Low Noise"
-  Tilt adjustment for adjusting the fan till 15° angle
-  Floating arrangement for changing the position of oscillation



Sweep Model	Sweep (mm)	RPM	Phase	Power Input (Watt)	Current (AMP)	Air Delivery (CMH)	Noise Level (DB)
450 mm AC(Stand)	450	1400	1	100	0.45	8000	60 – 65

INDUSTRIAL FANS

THUNDERSTORM PRO WALL FAN



Double ball-bearing



Powerful air circulating motor for continuous operation with high air delivery & thrust



It comes with the air direction control by telescopic height adjustment



Sturdy metallic body for "durability"



Motor protection and thermal overload protection device with auto-reset



Narrow aerodynamically designed blades for providing "Low Noise"



Tilt adjustment for adjusting the fan till 15° angle





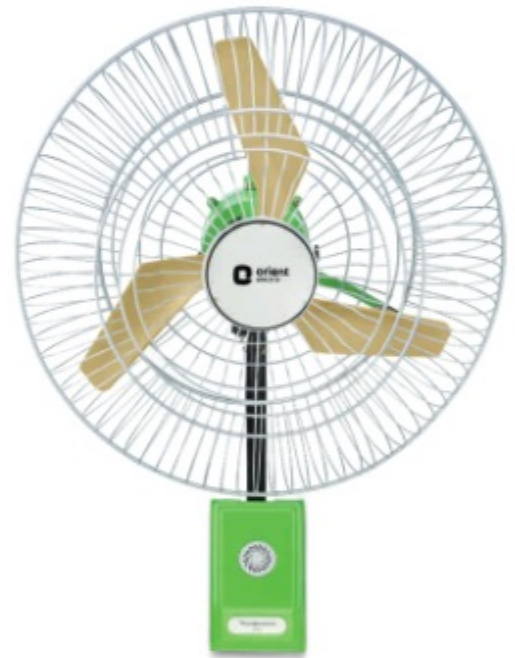





Floating arrangement for changing the position of oscillation



Sweep (mm)	RPM	Phase	Power Input (Watt)	Current (AMP)	Air Delivery (CMH)	Noise Level (DB)
600	1400	1	180	0.95	15000	65 - 70
750	1400	1	250	1.2	23000	70 - 75

INDUSTRIAL FANS

THUNDERSTORM PRO STAND FAN









-  Double ball-bearing
-  Powerful air circulating motor for continuous operation with high air delivery & thrust
-  It comes with the air direction control by telescopic height adjustment
-  Sturdy metallic body for "durability"
-  Motor protection and thermal overload protection device with auto-reset
-  Narrow aerodynamically designed blades for providing "Low Noise"
-  Tilt adjustment for adjusting the fan till 15° angle
-  Floating arrangement for changing the position of oscillation



Sweep (mm)	RPM	Phase	Power Input (Watt)	Current (AMP)	Air Delivery (CMH)	Noise Level (DB)
600	1400	1	180	0.95	15000	65 - 70
750	1400	1	250	1.2	23000	70 - 75

INDUSTRIAL FANS

WALL AC 18

-  High torque gear box with safety clutch
-  Best-in-category air thrust
-  3-speed control (in stand AC 18 only)
-  Broad blade profile for low noise
-  Up & down tilt mechanism
-  Motor protection and thermal overload protection device with auto-reset
-  90-degree oscillation
-  Spiral guard design ensure international safety standard
-  Powerful air circulating motor for high air delivery & thrust











IP55
Protected

Tolerance on ratings (As per IS 2997-1964) Speed -10% Power +10% Air Delivery -10%

Sweep Model	Sweep (mm)	RPM	Phase	Power Input (Watt)	Current (AMP)	Air Delivery (CMH)
450 mm (Stand/Wall)	450	1450	1	100	0.44	8100

INDUSTRIAL FANS

STAND AC 18

-  High torque gear box with safety clutch
-  Best-in-category air thrust
-  3-speed control (in stand AC 18 only)
-  Broad blade profile for low noise
-  Up & down tilt mechanism
-  Motor protection and thermal overload protection device with auto-reset
-  90-degree oscillation
-  Spiral guard design ensure international safety standard
-  Powerful air circulating motor for high air delivery & thrust



Tolerance on ratings (As per IS 2997-1964) Speed -10% Power +10% Air Delivery -10%

Sweep Model	Sweep (mm)	RPM	Phase	Power Input (Watt)	Current (AMP)	Air Delivery (CMH)
450 mm (Stand/Wall)	450	1450	1	100	0.44	8100

INDUSTRIAL FANS

WALL AC-24

-  High torque gear box with safety clutch
-  Best-in-category air thrust
-  Indexed floating system in the motor head
-  Up & down tilt mechanism
-  Motor protection and thermal overload protection device with auto-reset
-  90-degree oscillation
-  Spiral guard design ensure international safety standard
-  Powerful air circulating motor for high air delivery & thrust
-  Environment protection with durable powder coating



IP55
Protected

Tolerance on ratings (As per IS 2997-1964) Speed -10% Power +10% Air Delivery -10%

Sweep Model	Sweep (mm)	RPM	Phase	Power Input (Watt)	Current (AMP)	Air Delivery (CMH)
600 mm (Stand/Wall)	600	1450	1	200	0.87	15000

INDUSTRIAL FANS

STAND AC-24

-  High torque gear box with safety clutch
-  Best-in-category air thrust
-  Indexed floating system in the motor head
-  Up & down tilt mechanism
-  Motor protection and thermal overload protection device with auto-reset
-  90-degree oscillation
-  Spiral guard design ensure international safety standard
-  Powerful air circulating motor for high air delivery & thrust
-  Environment protection with durable powder coating



Tolerance on ratings (As per IS 2997-1964) Speed -10% Power +10% Air Delivery -10%

Sweep Model	Sweep (mm)	RPM	Phase	Power Input (Watt)	Current (AMP)	Air Delivery (CMH)
600 mm (Stand/Wall)	600	1450	1	200	0.87	15000

INDUSTRIAL FANS

HEAVY DUTY EXHAUST



Ip55 Protected

Sweep (mm)	Phase	RPM	Power (watt)	Current (AMP)	Air Delivery (CMH)	Noise label (DBA)
300	Single	900	50	0.24	1145	45
		1400	85	0.41	1710	50
380	Single	900	100	0.45	2000	55
		1400	155	0.70	3250	60
450	Single	900	150	0.67	3900	60
		1400	340	1.5	6120	70
600	Single	900	440	2	9400	70
380	Three	1400	160	0.3	3250	60
450	Three	1400	360	0.7	6120	70
600	Three	900	470	0.9	9400	70
450 Neo	Single	1400	280	1.3	6120	65

*300mm, 380mm, 450mm in 1400 rpm and 600mm in 900rpm, single phase are with ISI mark only.

IS 2312 - 1967







CHL-3062441

Contd...

INDUSTRIAL FANS

HEAVY DUTY EXHAUST

-  Pre-lubricated double ball bearing for maintenance free running
-  Aerodynamically contoured blades to handle maximum air delivery with minimum power consumption
-  Motor protected with thermal overload protection device
-  Class 'B' insulation
-  Epoxy powder coating to resist corrosion
-  Powerful air suction

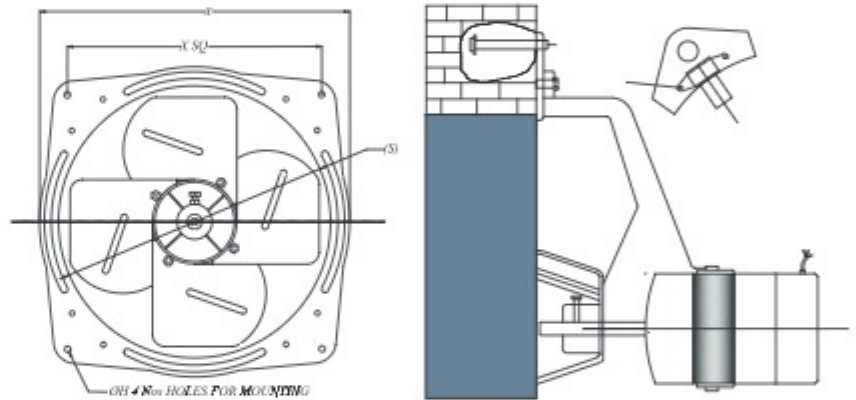

S. No.	Product	ØX	ØH	ØS	Y SQ
1.	Heavy-duty Exhaust Fan	384	7.8	320	313
2.	Heavy-duty Exhaust Fan	468	10.8	405	373
3.	Heavy-duty Exhaust Fan	548	10.8	484	447
4.	Heavy-duty Exhaust Fan	718	10.8	632	603

[HOME](#)
[ABOUT US](#)
[PRODUCTS](#)
[CONTACT](#)

PRODUCT COMPARISON

PREMIUM

Model	Sweep (in mm)	Power Consumption (in W)	Speed (in RPM)	AD (in CMM)	Warranty (in Years)	Star
Aeroquiet	1200	55	310	225	2	1
Aeroquiet baby	900	48	430	150	2	1
Aerostorm	1320	75	270	300	2	1
Subaris Remote	1300	67	250	270	2	1
Subaris Royal	1300	67	250	270	2	1
Subaris solo	1300	67	250	270	2	1
Spectra	1200	57	320	230	2	1
Stallion	1320	62	300	250	2	1

AIR CIRCULATORS

Model	Sweep (in mm)	Power Consumption (in W)	Speed (in RPM)	AD (in CMM)	Warranty (in Years)	Star
Woodwind	1300	80	220	215	2	NA

BLDC

Model	Sweep (in mm)	Power Consumption (in W)	Speed (in RPM)	AD (in CMM)	Warranty (in Years)	Star
Aerosense	1200	40	280	245	5	5
Aeon BLDC	1200	32	350	225	5	5
Aeroslim	1200	40 (+8 for LED)	310	260	3	5
Aerostorm BLDC	1200	40	290	245	5	5
Aeroquiet BLDC	1200	35	310	225	5	5
I Float BLDC IoT	1200	32	330	215	3	5
I Float BLDC	1200	32	330	215	3	5
Ecotech Supreme Remote	1200	28	370	220	3	5
Ecotech Supreme BLDC	1200	30	370	220	3	5
Ecotech Prime BLDC	1200	32	350	220	3	5
I Falcon BLDC	1200	32	350	225	3	5
I Falcon Remote	1200	32	350	225	3	5
I Falcon Deco	1200	30	350	225	3	5
Hector 500 Regulator	900, 1200, 1400	25, 32, 35	450, 350, 300	140, 230, 260	3	5
Hector 500 Remote	1200	28	350	230	5	5
Hector Deco	1200	30	350	230	5	5
Jazz BLDC	1200	33	350	215	3	5
Wendy BLDC	1200	35	350	230	3	5

[HOME](#)
[ABOUT US](#)
[PRODUCTS](#)
[CONTACT](#)

PRODUCT COMPARISON

DECORATIVE

Model	Sweep (in mm)	Power Consumption (in W)	Speed (in RPM)	AD (in CMM)	Warranty (in Years)	Star
Mozart	1200	55	350	220	5	1
Quasar	900, 1050, 1200, 1400	38, 45, 50, 60	400, 380, 320, 300	140, 165, 235, 260	2	900mm, 1050mm, 1200mm - 2 star*, 1400mm - 1 star*
Jazz Art	1200	53	370	215	2	1
Quadro Ornamental	1200	55	320	230	2	1
Wendy	900, 1200, 1400	37, 55, 55	400, 320, 300	155, 230, 250	2	900mm - 3 star*, 1200mm - 1 star*, 1400mm - 2 star*
Quasar Ornamental	600, 900, 1050, 1200, 1400	73, 38, 45, 50, 60	850, 400, 380, 320, 300	110, 140, 165, 235, 260	2	900mm, 1050mm, 1200mm - 2 star*, 1400mm, 600mm - 1 star*
Jazz	600, 900, 1050, 1200, 1400	73, 37, 45, 53, 60	850, 400, 380, 370, 300	110, 155, 165, 215, 250	2	900mm-2 star*, 1050mm - 2 star*, 600mm, 1200mm, 1400mm, - 1 star*
Gratia	600, 900, 1050, 1200, 1400	73, 38, 45, 53, 62	850, 400, 380, 370, 300	110, 140, 165, 215, 255	2	900mm-3 star*, 1050mm - 2 star*, 600mm, 1200mm, 1400mm, - 1 star*
Blanco	1200	55	370	220	2	1
Adonis	1200	53	370	220	2	1
Falcon Deco	1200	55	380	220	2	1
Fiona	1200	54	370	220	2	1
Blitz+	1200	53	380	215	2	1
Blitz	1200	50	350	210	2	1
Morace	1200	52	370	215	5	1
Kiara	1200	53	370	215	2	1

BASE

Model	Sweep (in mm)	Power Consumption (in W)	Speed (in RPM)	AD (in CMM)	Warranty (in Years)	Star
Falcon	400 600 , 900 ,1200 , 1400	73, 38, 53, 60	850, 450, 380, 300	110, 140, 215 , 245	5	*900mm- 2 star 600mm, 1200mm, 1400mm - 1 star*
New Breeze 3 Star	600, 900 , 1050, 1200, 1400	73, 38, 45, 44, 56	850, 400, 380, 320, 300	110, 140, 165, 225, 255	5	*900mm, 1050mm, 1400mm- 2 star 1200mm - 3 star* 600mm - 1 star*
New Breeze 1 Star	600, 1200	73, 55	850, 320	110, 220	5	1
Summer breeze pro	900, 1200, 1400	38, 53, 60	400, 370, 300	138, 215, 250	5	*900mm- 2 star 1200mm, 1400mm - 1 star*
Summer Cool	900 , 1050, 1200, 1400	38, 45, 55, 56	400, 380, 320, 300	140, 165, 220, 255	5	*900mm, 1050mm, 1400mm- 2 star 1200mm - 1 star*
New Air Plus	600, 900, 1050, 1200, 1400	73, 37, 45, 53, 58	850, 400, 380, 370,	300 110, 140, 165, 225, 250	2	*900mm, 1050mm - 2 star 1200mm, 1400mm - 1 star*
Falcon Speedstar	1200	55	380	230	5	1
New Air	600	73	850	110	2	1
Arina	1200	55	370	225	2	1
Smart Saver -50	1200	50	350	220	2	1

[HOME](#)
[ABOUT US](#)
[PRODUCTS](#)
[CONTACT](#)

PRODUCT COMPARISON

TPW

Model	Sweep (in mm)	Power Consumption (in W)	Speed (in RPM)	AD (in CMM)	Warranty (in Years)
STAND 37 Neo	400	110	2100	100	2
TABLE 27 Neo	400	110	2100	100	2
WALL 47	400	110	2100	100	2
STYLUS	400	80	1350	100	2
WIND-PRO	400	80	1350	100	2
TORNADO-II	450	90	1325	110	2
TORNADO WALL-II	450	90	1325	110	2
RETRO T12	300	60	2100	47	2
RETRO T16	400	56	1300	80	2
STAND 35	400	56	1300	80	2
RETRO T16HS	400	90	2100	85	2
STAND 35HS	400	90	2100	85	2
TABLE 27	400	110	2100	100	2
DESK 17	300	90	2100	80	2
DESK 25	400	50	1330	75	2
WALL 14	300	90	2100	80	2
WALL 47	400	110	2100	100	2
WALL 48	450	64	1330	92	2
DESK 71	400	58	1330	90	2
WALL 11	300	53	1400	50	2
WALL 43	400	58	1330	90	2
WALL 49	400	58	1330	90	2
STAND 37	400	110	2100	100	2
WALL 41	400	58	1330	90	2
WALL 44	400	50	1330	75	2
ROTO-53	400	58	1330	90	2
ZIPPY Pro	225	50	2500	35	2
FARATA FT-01	500	160	1400	167	2
STAND 38	450	64	1330	92	2
STAND 33	400	58	1330	90	2
STAND 31	400	58	1330	90	2
STAND 32	400	50	1330	75	2
DESK 26	400	58	1330	90	2

[HOME](#)
[ABOUT US](#)
[PRODUCTS](#)
[CONTACT](#)

PRODUCT COMPARISON

INDUSTRIAL

Model	Sweep (in mm)	Power Consumption (in W)	Speed (in RPM)	AD (in CMM)	Warranty (in Years)
THUNDERSTORM PRO WALL FAN	450	100	1400	8000	2
THUNDERSTORM PRO STAND FAN	450	100	1400	8000	2
THUNDERSTORM Pro WALL FAN	600	180	1400	15000	2
THUNDERSTORM Pro STAND FAN	600	180	1400	15000	2
THUNDERSTORM Pro WALL FAN	750	250	1400	23000	2
THUNDERSTORM Pro STAND FAN	750	250	1400	23000	2
WALL AC 18	450	100	1450	8100	2
STAND AC-18	450	100	1450	8100	2
STAND AC-24	600	200	1450	15000	2
WALL AC-24	600	200	1450	15000	2

HOME	ABOUT US	PRODUCTS	CONTACT	
OUR OFFICES		SERVICE BRANCH OFFICE		HEAD OFFICE

Region	Area	Updated Address and contact Details	Contact No.
South	Kerala	Mr. Manoj Ambady, Radco Marketing Pvt Ltd, Building No 3/214, 215, 216 Block No. 15, Paravoor Taluk, Floor, Ernakulam. Pin: 683501	8129821355
South	Chennai	Mr. Vishnu Kumar, Orient Electric Limited. Heavytrees, 2Nd Floor, Unit - B, New No: 47, Spur Tank Road, Chetpet, Chennai-600031. Tamil Nadu.	9600001639
South	Madurai	Mr. G . Praveen kumar, Rodco Marketing Pvt Ltd, 228, Lig Colony, K.K Nagar Madurai-625020.	9585252524
South	Hydrabad	Mr. Durgaprasad Rao, Orient Electric Ltd, 6-3-1090/CRK Plaza 2nd Floor, Raj Bhavan Road, Somajiguda, Hyderabad-500082, Telangana (India) .	9000134193
South	Banglore	Mr. Kuldip Pandey, Orient Electric Ltd, C/O, RPM Logistics Pvt Ltd. SY No. 73, Harokyanthana, Dasanapura Hobli, Makali (P) Tumkur Main Road Bengaluru-552162, Karnataka.	9919003378
South	Vijayawada	Mr. Prabhakar, Orient Electric Limited, D.No: 23-17/1, Warehouse 1, Kohinoor Estates, Opp Hil Limited, Vijayawada, Mylavaram RD, Kondapalli, I brahimpattanam -Andhra Pradesh-521228.	9908011447
North	Delhi	Mr. Vivek Sharma, Rajent Enterprises 3/15, Asaf Ali Road. New Delhi-110002	9999410680
North	Haryana	Mr. Sourav Singh / Mr. Neeraj Yadav, Alok Distributors, 14/3, Mathura Road, Behind PNB Bank, Mewala Maharajpur Metro Station, Hararyana-121003	96676 00151 / 9643001001
North	Rajasthan	Mr. RR Chowdhary / Mr Sunny Sambharwal, Rajasthan, Vasundhara International, D-2(B) Meera Marg, Karnal Vamdhavan, Bani Park, Rajasthan-302016	9001298201 / 76656 99996
North	Noida	Mr. Ramit Bhatnagar, D-209, Sector-63, Noida-201301 India.	9971397635
North	Lucknow	Mr. Sunil Srivastava, Orient Electric Limited-A CK Birla Group Company, 607, 6th Floor, Ratan Square 20-R Vidhan Sabha Marg, Lucknow- 226001.	9554338866
North	Chandigarh	Mr. Dinesh Trehan, Orient Electric Limited, SCO 840 1st Floor, Nac Manimajra, Chandigarh-161011.	9646009593
North	Amritsar	Mr. Gurmeet Singh, Daga Co. C-4, Baba Budha Ji Avenue, Opp Ashok Vatika Public School, New Amritsar-143006.	8725056304
West	Mumbai	Mr. Vishal, 604, Dev Corpora, 6th Floor, Cadbury Junction, Eastern Express Highway Thane (W), Mumbai 400601	9769208629
West	Pune	Mr. Vishal, Orient Agencies Sr No. 9, Daulati warehouse, Shivram Nagar, Katraj Mantarwadi Uruli Devachi, Pune 412308 Maharashtra	9769208629
West	Nagpur	Mr. Mangesh R Mahure, Orient Electric Limited, Block No. 402, 4th Floor, Shriyash Heights, Plot No. 95, Lendra West Precinct, Ramdaspeth, Nagpur-440010.	7738380770
West	Indore	Mr. Rajeev Dwivedi, Jalan Brothers Pvt. Ltd.; 4/1, Mangal Compound, Behind Mercedes-Benz Showroom, Dewas Naka, Indore-452010.	9826724892
West	Raipur	Mr. Jay Prakash, Jalan Brothers Pvt. Ltd., Kedia Business Park, Opp. National Garage G.E. Road, Tatiband, Raipur.	9131875970
West	Ahemdabad	Mr. Arpit Mahant, Opp- Sumar Logistic Park, Gr Floor, Building No 1, Rudra Pratap Logistic Park, survey No 102-2, Kajipura NH-64, Matar Industrial Area, Kheda, Gujarat, 387530	9662679540
East	Kolkata	Mr. Tushar Maji, Orient Electric Ltd. 6, Ghore Bibi Lane, Kolkata- 700054	9163335950
East	Bhubaneswar	Mr. Ajit Kumar, Orient Electric Ltd., Badhanpur, Puri By Pass Road, Bhubaneswar-751002	9097078864
East	Patna	Mr. Saket Dwivedy, Orient Electric Limited - A CK Birla Group Company 4th Floor, Sai Tower, Beside Hotel Utsav, New Dak Bunglow Road, Patna-800001, India.	9307777762
East	Ranchi	Mr. Anand Kumar, Jharkhand Orient Electric Limited, Office No. 401, Modi Heights, Phase-I, Ratu Road, Ranchi-834001.	7366965555
East	Guwahati	Mr. Manas Jyoti Bharadwaj, Branch Sales Manager, Orient Electric Limited, Nilakshi Talukdar Campus, Opp Vodafone Head Office, BH-37, Katabari Guwahati-781035, India.	9864058464

HOME	ABOUT US	PRODUCTS	CONTACT
----------------------	--------------------------	--------------------------	-------------------------

OUR OFFICES		SERVICE BRANCH OFFICE		HEAD OFFICE
-----------------------------	--	---------------------------------------	--	-----------------------------

Bangalore
 Mr. Dilip ,Orient Electric Limited ,
 Office:- Sy No-73, Harokyathanahalli,
 Dasnapura Hobli, Makali, Tumkur Road,
 Bengaluru - Karnataka
 Phone : 97409 9050

Cuttack
 Annada Prasana Dash, Orient Electric Limited
 Odisha Govt. Khewat No. 1, Khasra No 59 Plot
 No. 20/581 and Plot No 20/945,
 Badhanpur,Puri Bypass Road
 Bhubaneswar -751002 Odisha
 Phone : 8895040140

Lucknow
 Mr. Deepak Saxena -9792103005
 Orient Electric Limited, Lucknow.
 602, 6th Floor Ratan Square,20 A Vidhan
 Sabha Marg Lucknow - 226001 UP EAST
 Phone : 9792103005

Hyderabad
 Thrimurthy Yarubandi, 6-3-1090/C,R K Plaza,
 2nd floor,Rajbhavan Road, Somajiguda,
 Hyderabad-500082 Telangana,
 Phone : 9182760853

Ghaziabad
 Ghaziabad
 Vimal Ganotra Plot no 240
 Okhla Ind Area Phase III, New Delhi
 Phone : 9654515104

Patna
 Rajesh Kumar Singh , 9135843622 Orient
 Electric Limited 4th floor, Sai towerDak
 Bungalow road, Patna 800001(Bihar)
 Phone: 8969654163

Vijayawada
 Manoj Lingamgunta, #2-56, Sivalayam
 Street, Near Nagarjuna school Kondapalli
 521228 Dist. Krishna Andhra Pradesh
 Phone : 7997891234

Kolkata
 MR. Vivek Kumar , Orient Electric,
 Kolkata. 6 , Ghorebibi Lane.
 Kolkata-700054 West Bengal,
 Phone : 033- 40163600 / 8052094555

Ahmedabad
 Rakesh Vishwakarma, A307,
 Vrajdharm I, Near Ujala Circle,
 Sarkhej, Ahmedabad 382210
 Phone : 6353703956

Customer Care No.: 1800 103 7574 (Toll-Free)

Room Size (sqft)	Recommended Sweep Size for Ceiling Fans		
	mm	feet	inches
Upto 70	600	2.0	24
70	900	3.0	36
100	1050	3.5	42
160	1200	4.0	48
180	1300	4.3	52
225	1400	4.7	56

Important: To maximize air delivery over the required area, your Orient Electric ceiling fan should be 2.1 meter or more from the ground and 30cm or more below the ceiling. For large rooms with more than one fan, the center distance between each fan will depend on sweep sizes.

Sweep	1400mm	1200mm	1050mm	900mm
Center Distance	3m	2.5m	2m	1.8m

- Visuals shown in the brochure, may vary slightly from actual product
- Air delivery may vary ±5%
- All specifications are subject to change without any prior notice
- Models may change during the year

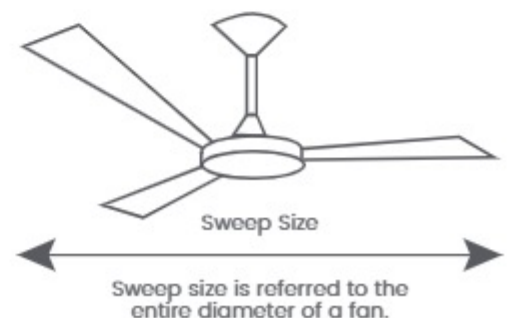

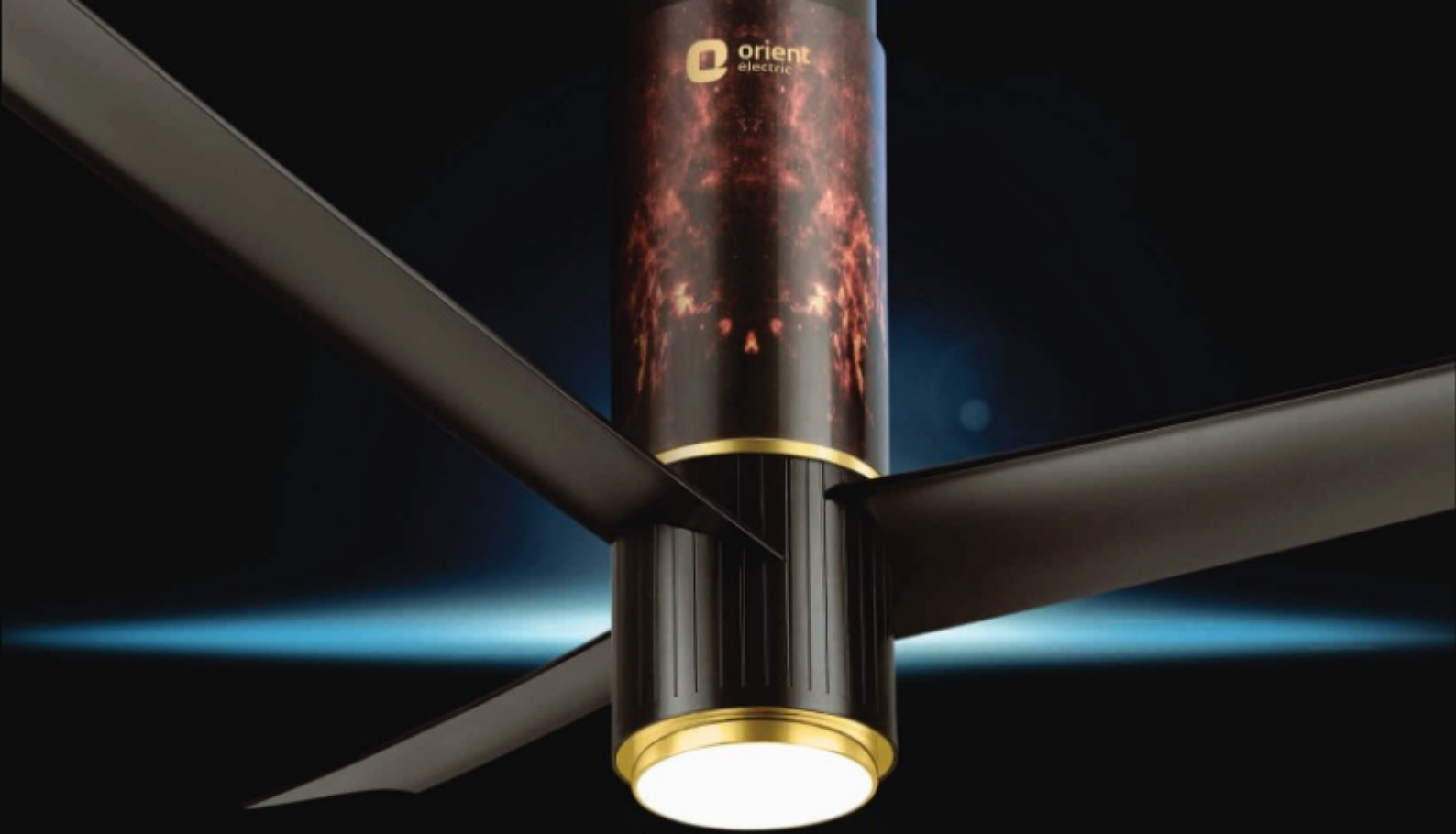

Fans



Appliances



Lighting



Switchgear

CK BIRLA GROUP



Fans | Home Appliances | Lighting | Switchgear

Orient Electric Limited (A CK Birla Group Company)

240, Okhla Industrial Estate, Phase-III, New Delhi - 110020. Orient Helpline no: 1800 103 7574 (Toll Free)

Email: customer.connect@orientelectric.com, Website: www.orientelectric.com

< **BACK**