

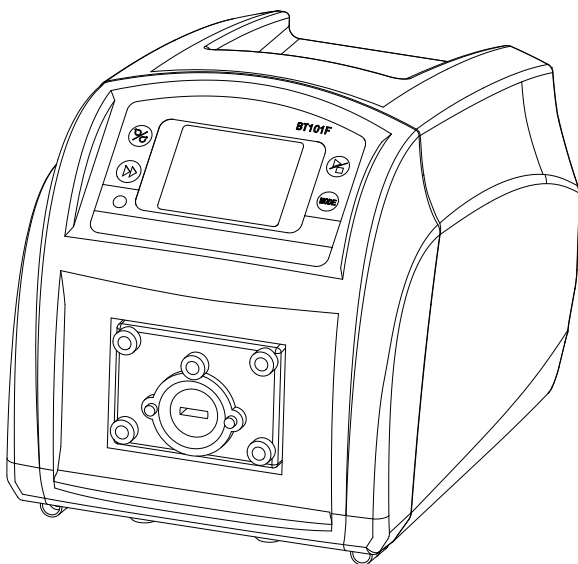

BT 101F/301F/601F

Intelligent Dispensing Peristaltic Pump

Operating Manual



Contents

1 Safety Precautions	1
2 Description	6
3 Functions and Features.....	6
4 Components and Connectors.....	8
5 Display Panel and Operating Keypads	8
5.1 Keypad.....	9
5.2 LCD Touch Screen Display.....	9
5.3 System Settings	15
6 External Control Interface.....	22
7 Operation Instructions	22
7.1 Before Operation.....	22
7.2 Power Connection.....	23
7.3 First Run Wizard	23
7.4 Flow Rate Calibration	24
7.5 Working Mode	27
7.6 Wizard.....	31
7.7 External Control Mode.....	34
7.8 Communication Mode	37
7.9 Footswitch	38
8 Maintenance	40
8.1 Warranty.....	40
8.2 Regular Maintenance	40
8.3 Malfunction Solutions	40
9 Dimensions	42
10 Naming Rule	43
11 Specifications	43

1 Safety Precautions



Danger

- Use the correct voltage indicated on the rating plate label of the pump to avoid any damage.
- Do not make any unauthorized dismantling, changes or modifications to the pump which could result in malfunctions or even potential accidents.
- Turn off the pump drive before installing or removing tubing, attempting any maintenance, cleaning or repair of the drive, connecting or disconnecting external control devices or a communication interface. Fingers or loose clothing could get caught in the drive mechanism.



Warning

- Ensure no chemical reactions occur between the handled fluid with the material of the pump head and tubing before use.
- Tubing should be checked regularly to avoid breakage. Tubing breakage may result in fluid being sprayed from the pump. Use appropriate measures to protect the operator and equipment. The operator is solely liable for damages resulting from tubing breakage, particularly the leakage of toxic or valuable liquids.
- The pump is provided with a grounded plug which must be well grounded at all times.
- This device is not designed for nor intended for usage in patient-connected applications, including but not limited to medical and dental use.
- Observe all other applicable regulations concerning working safety, operational safety, environmental protection and relevant local regulations.

(DE) SICHERHEITSHINWEISE



Gefahr

- Verwenden Sie die richtige Spannung, die auf dem Typenschild der Pumpe angegeben ist, um Schäden zu vermeiden.
- Nehmen Sie keine unbefugten Demontagen, Änderungen oder Modifikationen an der Pumpe vor, die zu Fehlfunktionen oder sogar zu Unfällen führen könnten.
- Schalten Sie den Pumpenantrieb aus, bevor Sie Schläuche ein- oder ausbauen, Wartungs-, Reinigungs- oder Reparaturarbeiten am Antrieb vornehmen oder externe Steuergeräte oder eine Kommunikationsschnittstelle anschließen oder trennen. Finger oder lose Kleidungsstücke können sich im Antriebsmechanismus verfangen.



Warnung

- Vergewissern Sie sich vor der Verwendung, dass keine chemischen Reaktionen zwischen dem Fördermedium und dem Material des Pumpenkopfs und der Schläuche auftreten können.
- Die Schläuche sollten regelmäßig überprüft werden, um Brüche zu vermeiden. Ein Schlauchbruch kann dazu führen, dass Flüssigkeit aus der Pumpe spritzt. Ergreifen Sie geeignete Maßnahmen zum Schutz des Bedieners und der Ausrüstung. Der Betreiber haftet allein für Schäden, die durch einen Schlauchbruch entstehen, insbesondere für das Austreten von giftigen oder wertvollen Flüssigkeiten.
- Die Pumpe ist mit einem geerdeten Stecker ausgestattet, der stets korrekt an eine abgesicherte Netzsteckdose angeschlossen sein muss. Dieses Gerät ist nicht für Anwendungen ausgelegt oder vorgesehen, die im Zusammenhang mit der Behandlung von Patienten stehen. Medizinische bzw. zahnmedizinische Anwendungen sind nicht bestimmungsgemäß.
- Beachten Sie alle anderen geltenden Vorschriften zur Arbeitssicherheit, zur Betriebssicherheit, zum Umweltschutz sowie die einschlägigen örtlichen Vorschriften.

(FR) CONSIGNES DE SÉCURITÉ**Danger**

- Utilisez la tension correcte indiquée sur la plaque signalétique de la pompe afin d'éviter tout dommage.
- Ne procédez pas à des démontages, changements ou modifications non autorisés de la pompe qui pourraient entraîner des dysfonctionnements, voire des accidents.
- Mettez l'entraînement de la pompe hors tension avant d'installer ou de retirer des tuyaux, d'effectuer des travaux d'entretien, de nettoyage ou de réparation sur l'entraînement ou de connecter ou déconnecter des dispositifs de commande externes ou une interface de communication. Des doigts ou des vêtements lâches pourraient se prendre dans le mécanisme d'entraînement.

**Avertissement**

- Avant toute utilisation, assurez-vous qu'il n'y a pas de réaction chimique entre le liquide pompé et le matériau de la tête de pompe et des tubes.
- Les tuyaux doivent être contrôlés régulièrement pour éviter les ruptures. Une rupture de tuyau peut entraîner des projections de liquide hors de la pompe. Prenez les mesures appropriées pour protéger l'opérateur et l'équipement. L'opérateur est seul responsable des dommages causés par une rupture de tuyau, notamment en cas de fuite de liquides toxiques ou précieux.
- La pompe est équipée d'une fiche de mise à la terre qui doit toujours être bien reliée à la terre.
- Cet appareil n'est pas conçu ni prévu pour être utilisé en présence de patients, y compris, mais sans s'y limiter, dans le cadre d'applications médicales et dentaires.
- Respectez toutes les autres réglementations applicables en matière de sécurité du travail, de sécurité d'exploitation, de protection de l'environnement.

(ES) INSTRUCCIONES DE SEGURIDAD



Peligro

- Utilice la tensión correcta indicada en la placa de características de la bomba para evitar daños.
- No realice ningún desmontaje, cambio o modificación no autorizada en la bomba que pueda provocar un mal funcionamiento o incluso accidentes.
- Desconecte el accionamiento de la bomba antes de instalar o retirar las mangueras, realizar trabajos de mantenimiento, limpieza o reparación en el accionamiento o conectar o desconectar dispositivos de control externos o una interfaz de comunicación. Los dedos o la ropa suelta podrían quedar atrapados en el mecanismo de accionamiento.



Advertencia

- Antes de usarla, asegúrese de que no hay reacciones químicas entre el medio bombeado y el material de la cabeza de la bomba y las mangueras.
- Las mangueras deben ser revisadas regularmente para evitar roturas. La rotura de una manguera puede hacer que salga líquido de la bomba. Tome las medidas adecuadas para proteger al operador y al equipo. El operador es el único responsable de los daños causados por la rotura de una manguera, especialmente por la fuga de líquidos tóxicos o valiosos.
- La bomba está equipada con un enchufe con toma de tierra que debe estar siempre bien conectado a tierra.
- Este aparato no está diseñado ni pensado para su uso en relación con los pacientes, incluyendo pero sin limitarse a las aplicaciones médicas y dentales.
- Respetar todas las demás normas aplicables en materia de seguridad laboral, seguridad operativa y protección del medio ambiente.

(IT) ISTRUZIONI DI SICUREZZA**Pericolo**

- Usare la tensione corretta indicata sull'etichetta della targhetta della pompa per evitare qualsiasi danno.
- Non eseguire smontaggi, cambiamenti o modifiche non autorizzati alla pompa che potrebbero causare malfunzionamenti o addirittura potenziali incidenti.
- Spegnerne l'azionamento della pompa prima d'installare o rimuovere tubi, tentare qualsiasi manutenzione, pulizia o riparazione dell'azionamento, collegare o scollegare dispositivi di controllo esterni o un'interfaccia di comunicazione. Dita o indumenti larghi potrebbero rimanere impigliati nel meccanismo di azionamento.

**Attenzione**

- Assicurarsi che non si verifichino reazioni chimiche tra il fluido trattato e il materiale della testa della pompa e dei tubi prima dell'uso.
- I tubi devono essere controllati regolarmente per evitare rotture. La rottura del tubo può provocare spruzzi di fluido dalla pompa. Utilizzare misure appropriate per proteggere l'operatore e l'attrezzatura. L'operatore è l'unico responsabile dei danni derivanti dalla rottura dei tubi, in particolare della fuoriuscita di liquidi tossici o preziosi.
- La pompa è dotata di una spina con messa a terra che deve essere sempre ben collegata a terra.
- Questo dispositivo non è progettato né destinato all'uso in applicazioni collegate al paziente, incluso ma non limitato all'uso medico e dentistico.
- Osservare tutte le altre norme applicabili riguardanti la sicurezza sul lavoro, la sicurezza operativa, la protezione dell'ambiente e le norme locali pertinenti.

2 Description

The BT-01F intelligent dispensing peristaltic pump provides a simple and intuitive operating interface through the use of color LCD touch screen. It offers four operation modes: Volume Dispense Mode, Time Dispense Mode, Copy Dispense Mode and Flow Mode. The Anti-drip function ensures dispense accuracy. The intelligent temperature control technology is used for quiet operation. RS485 communication, compatible with Modbus protocol, makes it easier to connect to external devices such as PCs, HMIs, and PLCs.

This pump series includes:

- BT101F, flow rate: 0.0001-720 mL/min, speed: 0.1-150 rpm
- BT301F, flow rate: 0.006-1600 mL/min, speed: 0.1-350 rpm
- BT601F, flow rate: 0.006-2900 mL/min, speed: 0.1-600 rpm

3 Functions and Features

Peristaltic pumps can handle fluid that is particularly abrasive, corrosive or viscous. There are no seals in contact with the medium pumped and no valves to clog. The inner surfaces are smooth and easy to clean. The fluid contacts only the tubing or tube material. Suction lift and priming can be up to 8m water column at sea level. It can handle the most shear sensitive of fluids like latex or firefighting foam with low shearing. It is capable of running dry and pumping fluids with high quantities of entrained air, such as black liquor soap. The high volumetric efficiency allows operation in metering or dosing applications where high accuracy is required. Tubing and tube materials are available for food and pharmaceutical use.

- Color LCD, touch screen and keypad for operation.
- Reversible direction, start/stop control and adjustable speed.
- Precise motor control technology improves dispense accuracy
- Anti-drip function ensures dispense accuracy.
- Three dispense modes:

- Time Dispense Mode: automatically dispense by setting the duration for each dose, the lag time between doses and the number of cycles.
 - Volume Dispense Mode: automatically dispense by setting the volume for each dose, the lag time between doses and the number of cycles.
 - Copy Dispense Mode: automatically dispense by setting the total dispense volume, the lag time between doses and the number of cycles.
- Store five groups of working parameters for each dispense mode (power-off memory).
 - Flow rate display and control; cumulative dispense volume display.
 - Flow rate calibration.
 - 0.2% high precision rotating speed control with 0.1 rpm speed resolution.
 - Professional operating system, configure the system with a setup wizard.
 - Intelligent temperature control to minimize working noise.
 - A logic level signal can control start/stop, direction and easy dispense functions. An external analog signal can adjust the rotating speed. The signal is optically isolated.
 - With the RS485 MODBUS interface, easy to communicate with external devices.
 - Internal double-deck isolation structure.
 - Circuit board with conformal coating for dust-proof and moisture-proof.
 - Anti-electromagnetic interference feature, wide input voltage range for complex power environment.
 - ABS plastic housing, streamlined shape.
 - Drive multi-channels and various types of pump heads.
 - Optional footswitch and remote infrared control.

4 Components and Connectors

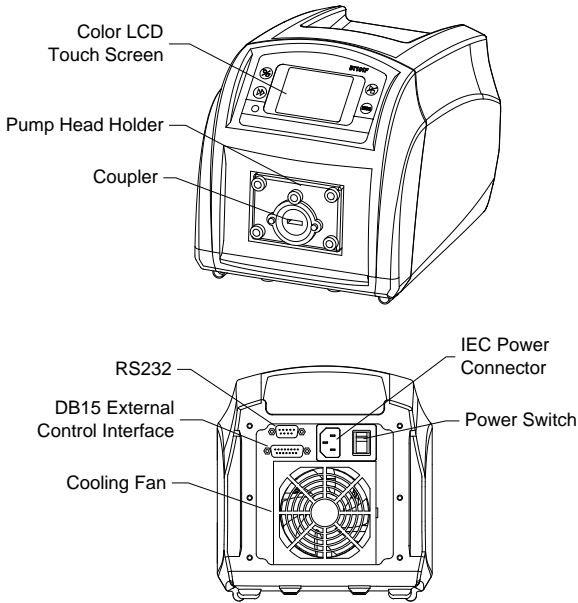

Figure 1. Components and Connectors

5 Display Panel and Operating Keypads

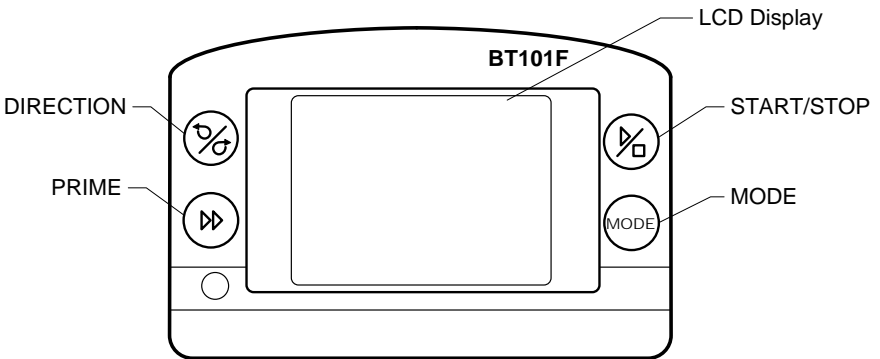

Figure 2. Display Panel

5.1 Keypad



START/STOP key. Press to start or stop the drive.



DIRECTION Key. Press to change the drive rotating direction, clockwise or counterclockwise.



PRIME key. Press the key to run the pump at the maximum allowed speed in the direction shown on the display. Press again to return to the previous state.



MODE key. When the drive is not running, use the MODE key to change the working mode. When the keypad is locked, use the MODE key to change the display content.

5.2 LCD Touch Screen Display

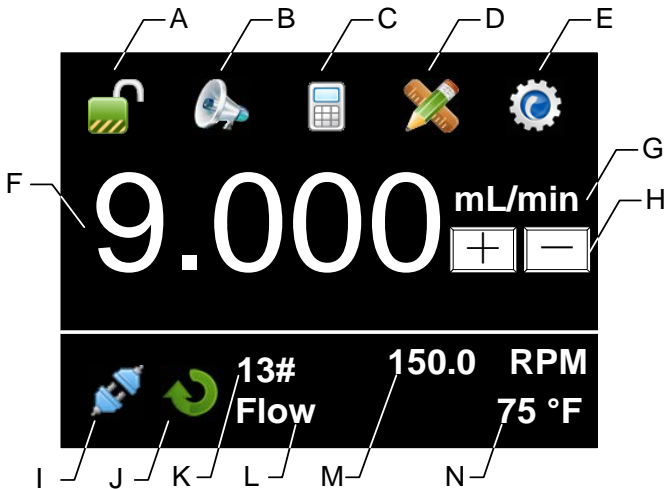

Figure 3. Main screen

5.2.1



A - Keypad Lock

It shows the state of the keypad lock. Press the icon to lock/unlock the keypad. When the keypad is locked, the control mode and system parameter settings can not be changed; use the MODE key to change the display content.

Password can be set to unlock the keypad. It will prevent a user from changing the system parameters accidentally.

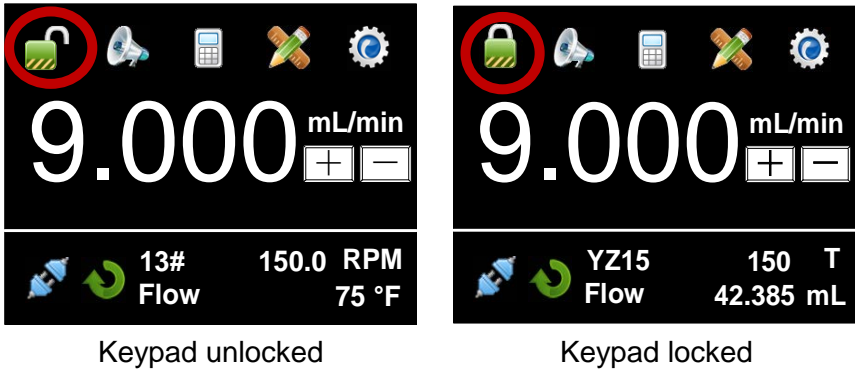

Figure 4. Keypad Lock

5.2.2 B - Tone Button

Press this icon to turn on/off the key tone.



Figure 5. Key Tone

5.2.3 C - Control Mode

Press this icon to enter the Control Mode interface. There are four control modes available.

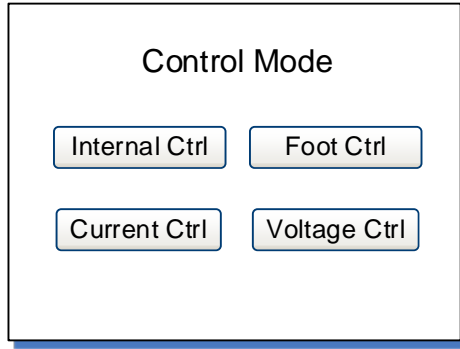

Figure 6. Control Mode

- **Internal Ctrl** - Internal Control Mode: operate the pump with keypad and touch screen.
- **Foot Ctrl** - Footswitch Control Mode: use a footswitch to control start/stop, and use the keypad and touch screen for the other operations.
- **Current Ctrl** - Current Control Mode: external 4-20mA analog current signal controls rotating speed, and logic level signal controls start/stop. The keypad is disabled.
- **Voltage Ctrl** - Voltage Control Mode: external 0-5V or 0-10V analog voltage signal controls rotating speed, and external logic level signal controls start/stop and direction. The keypad is disabled.

The screen will show the corresponding icon for the control mode you have selected.



Internal Control
Mode



Footswitch
Control Mode



Current Control
Mode



Voltage Control
Mode

Figure 7. Control Mode Icon



5.2.4 D - Quick Settings

Press this icon to enter the Quick Settings interface to reset the cumulative volume and cycles. For the three dispense modes, there are five groups of preset data. Press Prev or Next button to select the desired data group, and then press Return to confirm and return to the main screen. The setting on the main screen will change according to the selected data group.

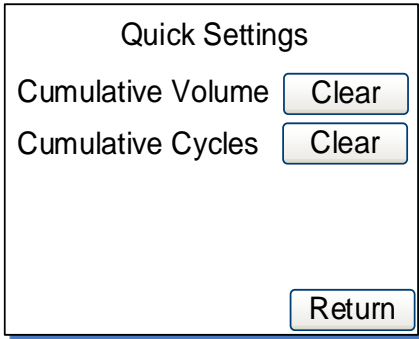

Flow Mode

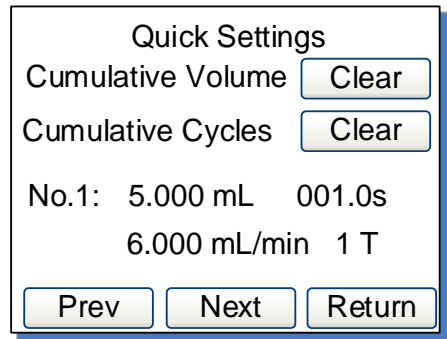

Other Modes

Figure 8. Quick Settings



5.2.5 E - System Settings

Press this icon to enter the System Settings menu, and then change the parameters shown on the screen.

5.2.6 F - Flow Rate Setting

It shows the current flow rate setting. When the drive is not running, press it to input desired value in the pop-up window. Please pay attention to the range of the value and flow rate unit.

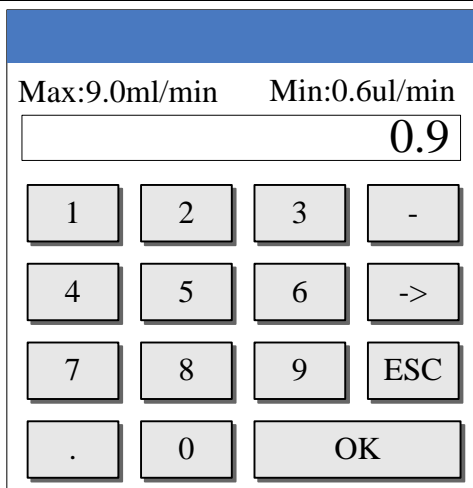



Figure 9. Flow Rate Setting

5.2.7 G - Flow Rate Unit

It shows the current flow rate unit. When the drive is not running, press it to change the unit. The allowed units are $\mu\text{L}/\text{min}$, mL/min and L/min .

5.2.8 H - Fine Adjustment Button

When the drive is running, press the fine adjustment button to adjust the flow rate in real-time. Press the  button or  button shortly to increase or decrease the flow rate. Press and hold the buttons to change the value quickly.

5.2.9 I - Communication State

It shows the current RS485 communication state.



Communication
connected



Communication
disconnected

Figure 10. Communication State

5.2.10 J - Rotation Direction

It shows the current rotation direction. When the drive is not running, it will show one of the following icons.



Clockwise



Counterclockwise

Figure 11. Direction State

When the drive is running, it will change to an animated icon as shown below.

*Figure 12. Running Animation*

5.2.11 K - Tubing or Pump Head

It shows the currently configured tubing size or a pump head model.

- 17# means that the tubing size is 17#.
- ID0.13 means that the internal diameter of the tubing is 0.13mm.
- YZ15 means that the pump head is YZ15.

5.2.12 L - Working Mode

It shows the current working mode, such as Flow Mode, Volume Dispense Mode, Time Dispense Mode or Copy Dispense Mode.

5.2.13 M - Speed or Cumulative Cycles

It shows current speed or cumulative dispense cycles, switched by pressing the MODE key. If the speed is higher than the maximum allowed speed, it will show **U_Overflow**; if the speed is lower than the minimum allowed speed, it will show **D_Overflow**. The cumulative cycles can be reset on the Quick Settings menu.

5.2.14 N - Internal Temperature or Cumulative Volume

It shows the temperature inside the drive or cumulative volume that the pump has delivered. The cumulative volume can be reset on the Quick Settings menu.

The default display temperature is in Fahrenheit. To change the display temperature in Celsius, please go to the System Information window (see Figure 23) and press the “75 °F” area, the display will change to Celsius-24 °C. Press the “24 °C” area again, the display will switch back to Fahrenheit.

5.3 System Settings

When the drive is not running, press the icon  to enter the System Settings menu.

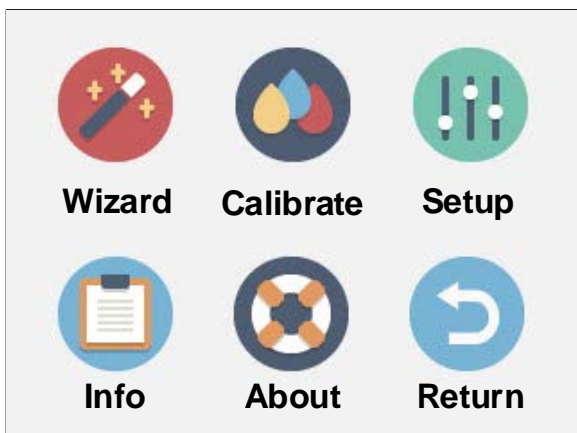

Figure 13. System Settings

5.3.1 Wizard

It's a Wizard to set up the parameters. The system will select the appropriate tubing and pump head for you.

5.3.2 Calibrate

The pump will accurately show the current flow rate/volume after Flow Rate Calibration.

Note: The calibration is necessary to display the flow rate precisely.

5.3.3 Setup

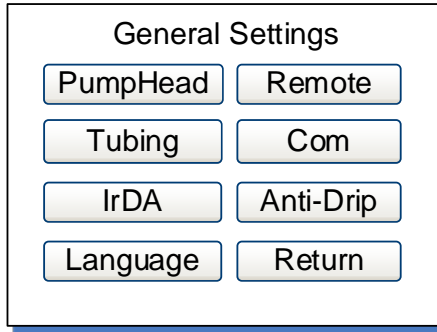

Figure 14. General Settings

- **PumpHead** - Choose the model of the installed pump head.

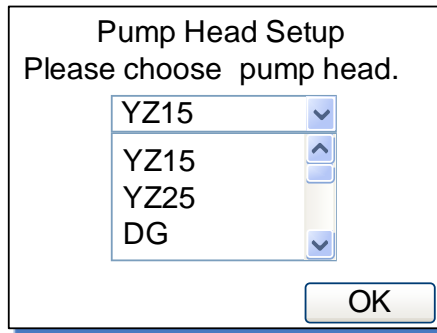

Figure 15. Pump Head Select

- **Tubing** - Choose the appropriate tubing size for the selected pump head.

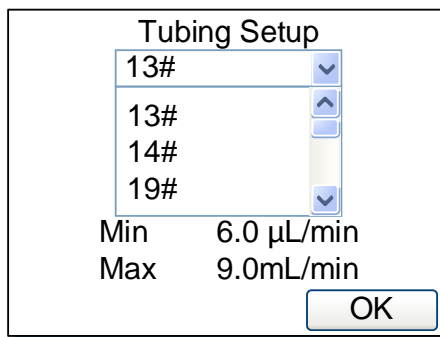

Figure 16. Tubing Select

- **IrDA** - Turn on/off the infrared control function.

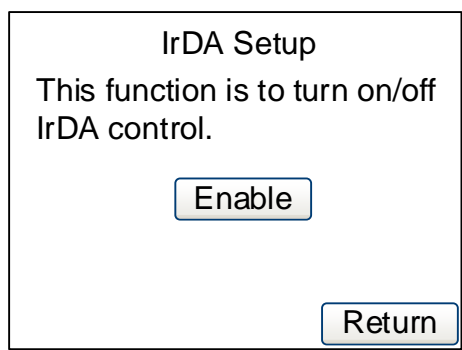

Figure 17. IrDA Setup

- **Language** - Choose display language, Chinese or English.



Figure 18. Language Select

- **Remote**

It is the setting for external control mode: Logic Level control mode or Pulse control mode. When it is set to Logic Level, the pump state will change when the external switch is closed or open. It is designed for a maintained switch. When it is set to Pulse, the pump state will change when the switch is closed and then open again. It is designed for a normally open momentary switch.

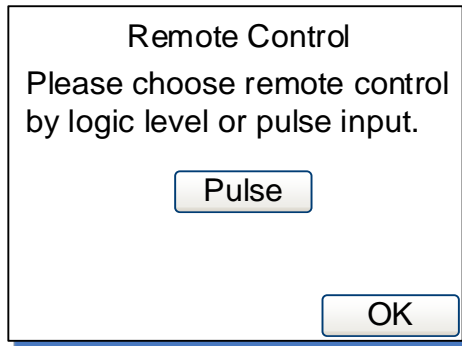

Figure 19. Remote Control Mode

- **Com**

It is the setting for RS485 MODBUS communication including baud rate, transmission mode and pump address. To change the address, click the address number on the screen, then input the value in the pop-up window. Restart the pump to apply the settings.

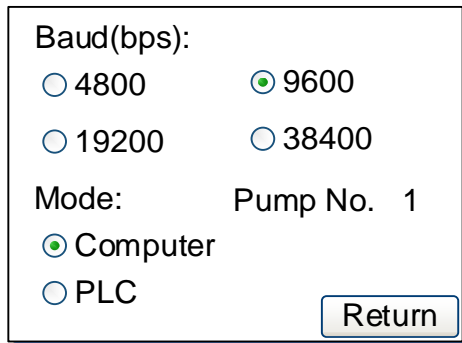

Figure 20. Communication Settings

- **Anti-Drip**

The pump provides a deceleration time setting to reduce fluid splash at the end of a dispense. It is the time for the drive to stop from the running speed to 0. In addition, to minimize the drip after a dispense, the drive can reverse direction to draw the fluid back at the end of the tubing. To access this feature, set the reverse angle/rotating speed in the pop-up window. When the angle is set to 0, this feature is disabled.

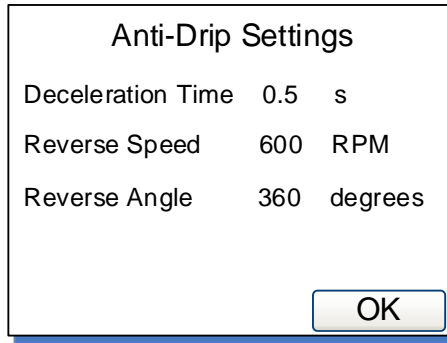

Figure 21. Anti-Drip Settings

5.3.4 Info

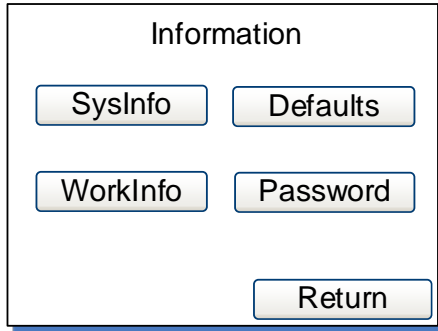

Figure 22. Information

It is about pump information.

- **Sysinfo**

It shows the software version, memory size, internal temperature, etc.

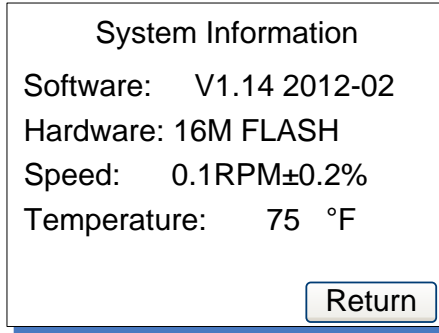

Figure 23. System Information

- **Workinfo**

It shows total power on time, running time and power cycles.

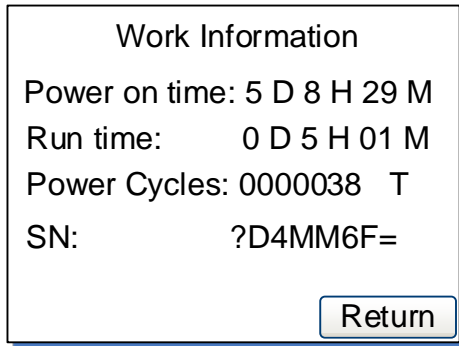



Figure 24. Work Information

- **Defaults**

It is to reset the pump to factory settings. Restart the pump to apply the settings. The system can also restore to factory settings by holding

the  and  at the same time when the pump powers on, then releasing the keys after the beep.

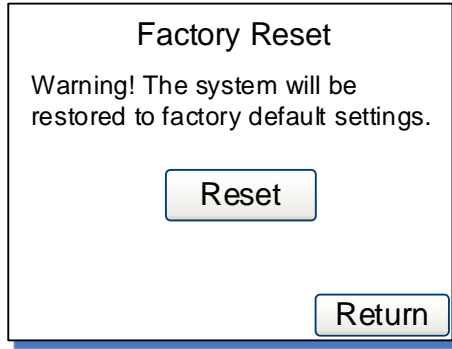

Figure 25. Factory Reset

- **Password**

It is to set a password to unlock the keypad. It will prevent a user from changing parameters accidentally. The default password is empty.

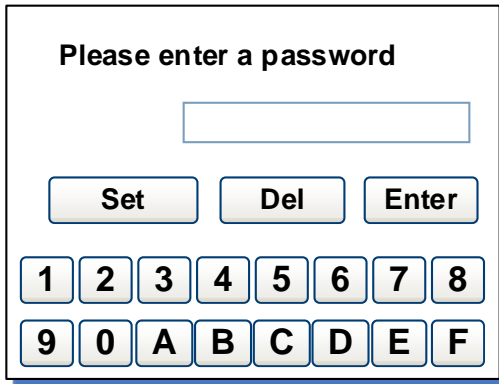

Figure 26. Password

5.3.5 About

It shows the functions and features of the pump.

5.3.6 Return

To return the main display screen.

6 External Control Interface

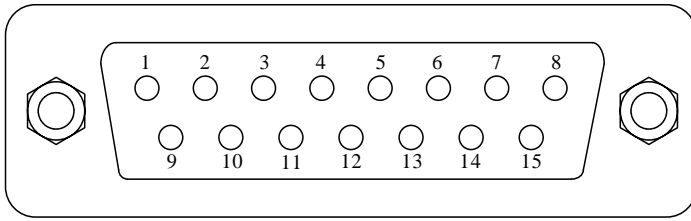

DB15	Mark	Note
1	ADC_W	Positive of external analog input
2	B	Communication interface, B pole of RS485
3	A	Communication interface, A pole of RS485
4	VCC_W	External DC power input
5	DAC	Analog voltage signal output
6	CW_W	External input signal to control the
7	PWM	Pulse signal output
8	COM	Ground of external power
9	AGND	Negative of analog signal input
10	+12V	Positive of internal +12V power source
11	GND	Ground of Internal power source
12	CW	Direction signal output
13	RS_W	External start/stop signal input
14	PWM_W	Pulse signal input
15	RS	Start/stop signal output

7 Operation Instructions

7.1 Before Operation

- 1) Please check the packing slip to ensure all parts are included and intact in the package. If there is a problem, please contact the manufacturer or distributor.
- 2) Read through the instruction.

- 3) A minimum of 200 mm space from the back of the pump should be maintained when it is in operation.

7.2 Power Connection

The voltage of the power supply should be marked on the sticker of the pump. Please make sure to use the right power source for the pump. Please plug the power cord into the power connector on the rear of the pump and plug the opposite end of the power cord into an electrical outlet. Flip the power switch located on the rear of the pump.

7.3 First Run Wizard

When using the pump for the first time or after a factory reset, the system will show a welcome screen. The next step is to choose the model number of the pump head installed. The system will run Pump Head Setup -> Tubing Setup -> Anti-Drip setup -> Working Mode setup -> Calibration in sequence. A user can set the parameters and operation mode according to the requirement. The pump will save the information and you only need to run the wizard once.

The image displays four sequential screenshots of the pump's First Run Wizard interface:

- Welcome Screen:** A text box with the message "Welcome to use First Run wizard. Please check the user manual for details if you have any questions." and a "continue" button at the bottom.
- Pump Head Setup:** A screen titled "Pump Head Setup" with the instruction "Please choose pump head." It features a dropdown menu with options "YZ15", "YZ15", "YZ25", and "DG". The "YZ15" option is selected. An "OK" button is at the bottom right.
- Tubing Setup:** A screen titled "Tubing Setup" with a dropdown menu showing "13#", "13#", "14#", and "19#". Below the menu, it specifies "Min 6.0 μL/min" and "Max 9.0 mL/min". An "OK" button is at the bottom right.
- Anti-Drip Settings:** A screen titled "Anti-Drip Settings" with three rows of settings: "Deceleration Time 0.5 s", "Reverse Speed 600 RPM", and "Reverse Angle 360 degrees". An "OK" button is at the bottom right.

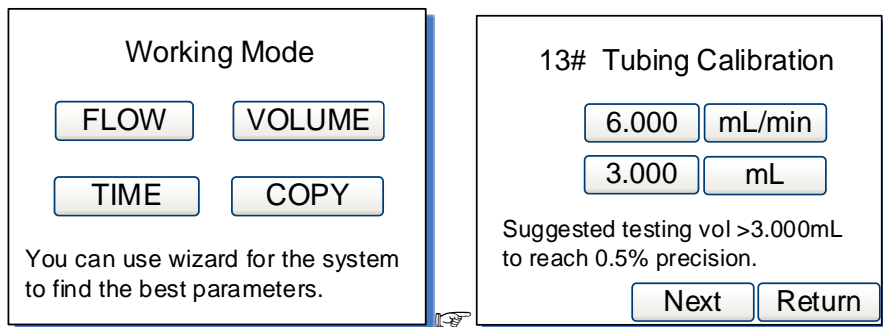



Figure 27. First Run Wizard

7.4 Flow Rate Calibration

The calibration must be done when

- First time using the pump
- The pump head is changed
- Tubing is replaced
- Transfer fluid in one channel with dual pump heads
- Tubing is reinstalled
- After continuous work for a long time

How to calibrate

- 1) Install pump head and tubing.
- 2) In the General Settings window, set the model number of the installed pump head.
- 3) When the pump shows the Main screen, press PRIME  to prime the pump.
- 4) When the drive is not running, press the System Settings icon , then select Calibrate.

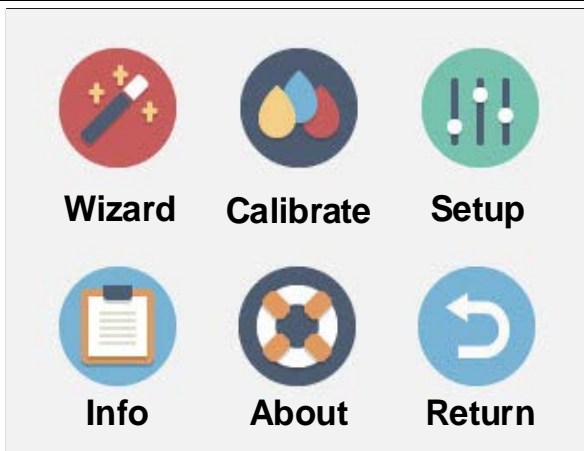

Figure 28. System Settings

- 5) In the calibration wizard window, it shows the currently selected tubing, desired flow rate and the suggested volume to test.

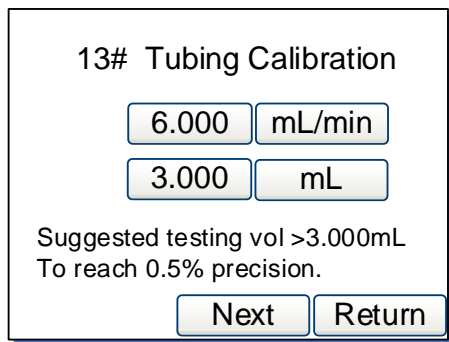

Figure 29. Flow Rate Calibration

The 6.000 mL/min is the desired flow rate and 3.000 mL is the suggested volume needed to test. The values or the units can be adjusted directly when pressing the button. Press the Next button to enter the calibration window, or press the Return button to exit the wizard to the System Settings window.

Note: The fluid volume should not be less than the suggested value.

- 6) Test window is shown below.

Press start/stop key to test, then input the data.

Test1	0.000	mL
Test2	0.000	mL
Test3	0.000	mL

Prev Next Return

Figure 30. Calibration

Press the START/STOP key, the pump will start to transfer fluid. Wait for the pump to finish testing, and then measure the delivered volume. Repeat the above steps a couple more times, and enter the results of Test1, Test2 and Test3 in the calibration window. Please pay attention to the unit to make sure it is correct. Press Next to enter Analyze and Calculate window.

If you want to modify the desired flow rate and volume to test, press the Prev button to re-enter the values. Then input the results into the system. The system will ignore the result of 0 and will only use the results you input to calculate the right speed for the desired flow rate.

Note: Please press the START/STOP key to stop the test anytime when an accident occurs during the test.

- 7) The corrected testing scale will be calculated and the old scale is also displayed on the screen for reference only.

Analyze and Calculate

Average Vol	3.068	mL
Cal scale	208.6957	
Re scale	213.3330	
Old scale	213.3330	

Prev Return OK

Figure 31. Analyze and Calculate

The scale is a coefficient for the tubing. The calculated scale should be close to the reference scale (the “Re scale” shown in *Figure 31*). Otherwise, please check the following and press Prev to test again.

- The accuracy of the volume measurement
- The volume unit setting
- The model of the pump head setting
- The tubing size setting
- The liquid viscosity. When it is too high, the flow rate may not be linear to the speed.
- If dual pump heads are used for one channel

If no problem is found, press the OK button to save the new value. The pump will adjust the speed according to the calculated scale. Or press Return to exit without saving the new value and return to the System Settings window.

If there is no data input to the system, it will show the window as below. Please press Prev to test again or just press Return.

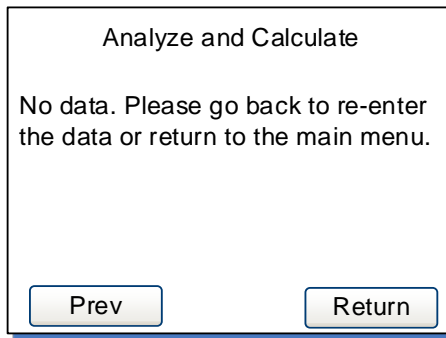

Figure 32. No Input Data

7.5 Working Mode

When the drive is not running, press the MODE key to enter the Working Mode window as shown below.

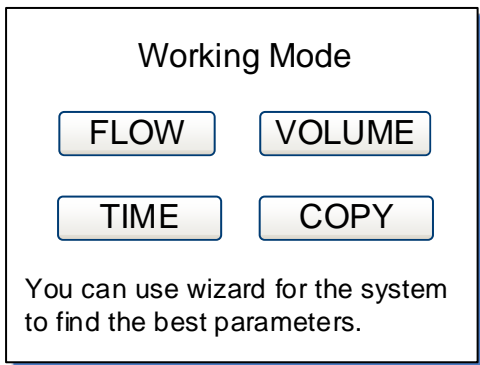

Figure 33. Working Mode

- **FLOW - Flow Mode**

In this mode, the pump will be running according to the set flow rate, and record the cumulative fluid volume.

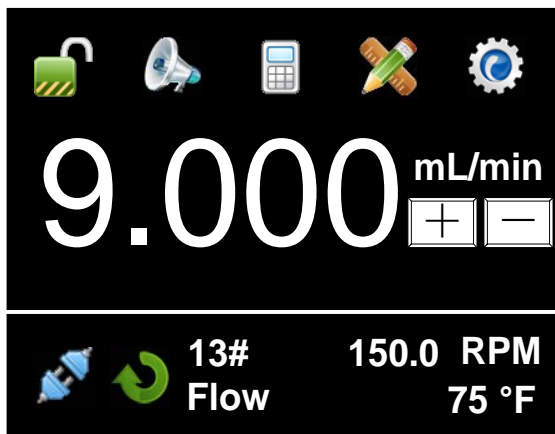

Figure 34. Flow Mode

- **VOL - Volume Dispense Mode**

In this mode, the pump will dispense by setting dispense volume for each dose, lag time between doses and number of cycles. The system will calculate the duration time for each dose automatically.

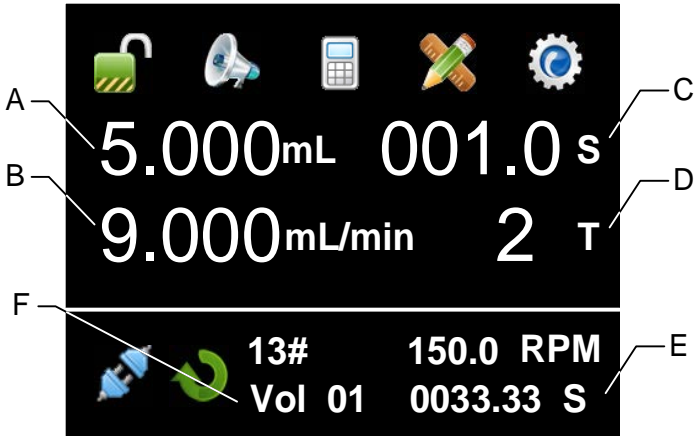

Figure 35. Volume Dispense Mode

A - Dispense volume for each dose, μL , mL or L.

B - Dispense flow rate, $\mu\text{L}/\text{min}$ or mL/min.

C - Lag time. The time between doses.

D - Dispense cycles. When setting dispense cycles to 0, the drive will keep running until the START/STOP key is pressed. When setting dispense cycles to 1, the drive will run only once, and the lag time setting is invalid. When setting dispense cycles to more than 1, the drive will run the set number of cycles and then stop.

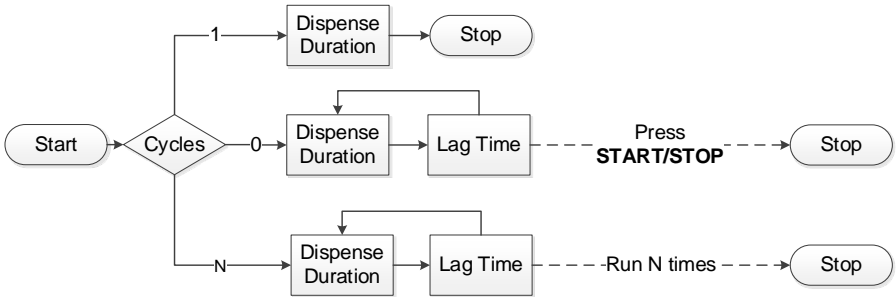

Figure 36. Dispense Cycles

E - Dispense duration for each dose. According to the dispense volume and time, the system will calculate dispense duration automatically.

F - Volume Dispense Mode, with group 1 data. The data group can

be selected from the Quick Settings menu.

- **TIME - Time Dispense Mode**

The pump will dispense by setting the dispense duration for each dose, lag time between doses and number of cycles. The system will calculate the dispense volume for each dose automatically.

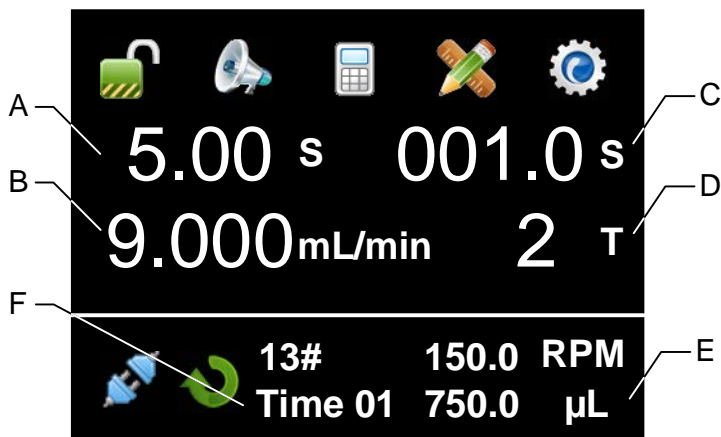

Figure 37. Time Dispense Mode

A - Dispense duration for each dose

B - Dispense flow rate, mL/min or L/min.

C - Lag time. The time between doses.

D - Dispense cycles. When setting dispense cycles to 0, the drive will keep running until the START/STOP key is pressed. When setting dispense cycles to 1, the drive will run only once. The lag time setting is invalid. When setting dispense cycles to more than 1, the drive will run the set number of cycles and then stop.

E - Dispense volume for each dose. According to the dispense duration and flow rate, the system will calculate the dispense volume for each dose automatically.

F - Time Dispense Mode, with group 1 data. The data group can be selected from the Quick Settings menu.

- **COPY - Copy Dispense Mode**

The pump will dispense by setting the total dispense volume, the lag

time between doses and number of dispense cycles. The system will calculate the dispense volume for each dose automatically.

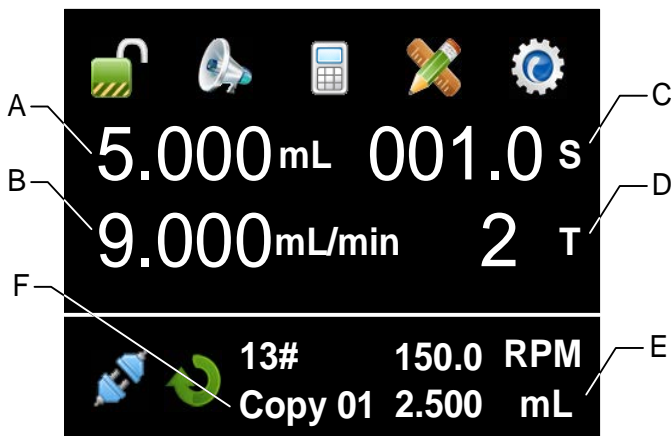

Figure 38. Copy Dispense Mode

A - Total dispense volume, μL , mL or L

B - Dispensing flow rate, $\mu\text{L}/\text{min}$, mL/min

C - Lag time. The time between doses.

D - Dispense cycles. When setting dispense cycles to 0, the drive will keep running until the START/STOP key is pressed. When setting dispense cycles to 1, the drive will run only once. The lag time setting is invalid. When setting dispense cycles to more than 1, the drive will run the set number of cycles and then stop.

E - Dispense volume for each dose. According to the total dispense volume and number of cycles, the system will calculate the dispense volume for each dose automatically.

F - Copy Dispense Mode, with group 1 data. The data group can be selected from the Quick Settings menu.

7.6 Wizard

The system will help you to choose the appropriate pump head and tubing size automatically by running this wizard.

- 1) When the drive is not running, press the icon , then select Wizard. The pump will display a Welcome screen. Press Next to

enter the parameter setup interface.

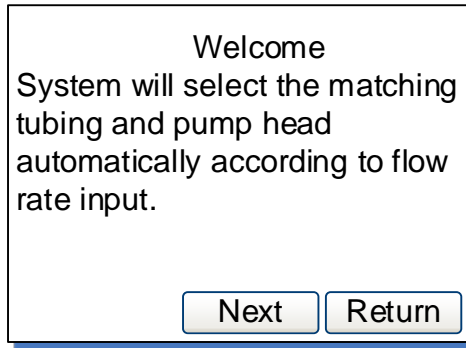

Welcome
System will select the matching
tubing and pump head
automatically according to flow
rate input.

Next Return

Figure 39. Welcome Screen

2) Input the required values as shown below.

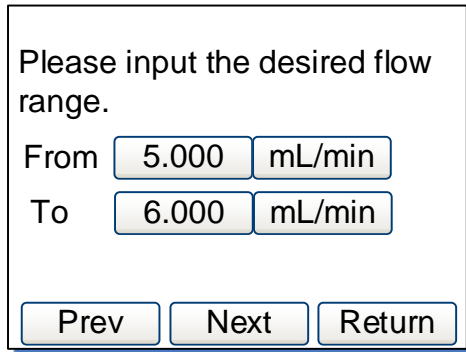

Please input the desired flow
range.

From

To

Prev Next Return

Figure 40. Flow Mode

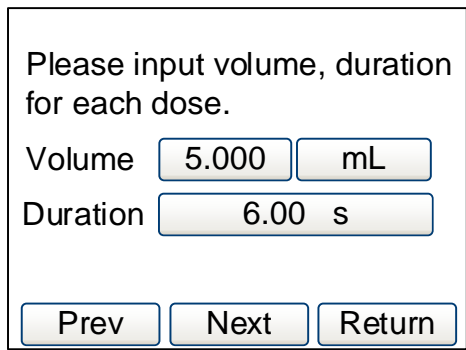

Please input volume, duration
for each dose.

Volume

Duration

Prev Next Return

Figure 41. Volume/Time Dispense Mode

Please input total volume, cycles and duration for each dose.

TotalVol

Cycles

Duration

Figure 42. Copy Dispense Mode

- 3) Press the Next button, the system will list appropriate pump heads automatically. Select the desired pump head and tubing, and press Next to set up lag time and cycles. If there is no pump head listed, go back to re-enter the data.

Please select one set of the matching pump head and tubing.

YZ15	13#	<input type="button" value="v"/>
YZ15	13#	<input type="button" value="^"/>
YZ15	14#	<input type="button" value="v"/>
YZ15	19#	<input type="button" value="v"/>

Figure 43. Appropriate Pump Heads List

No matching pump head found.

<input type="button" value="v"/>
<input type="button" value="^"/>
<input type="button" value="v"/>

Figure 44. No Appropriate Pump Head

- 4) Other Parameter Settings, for the lag time between doses and number of cycles.

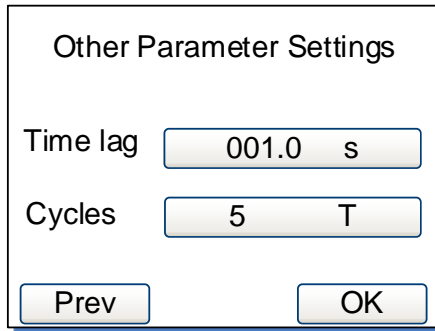

Other Parameter Settings

Time lag 001.0 s

Cycles 5 T

Prev OK

Figure 45. For Volume/Time Dispense Mode

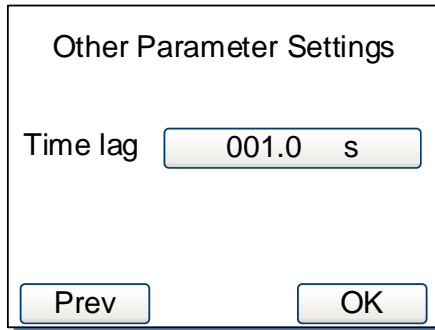

Other Parameter Settings

Time lag 001.0 s

Prev OK

Figure 46. For Copy Dispense Mode

7.7 External Control Mode

In this mode, the external logic level signal controls the direction and start/stop. External analog signal controls rotating speed. The keypad is disabled. The analog signal could be 0-5V, 0-10V or 4-20mA. By default, the signal is 0-5V. For 0-10V or 4-20mA, the jump setting on the analog signal control board has to be changed.

BT-01F Intelligent Dispensing Peristaltic Pump



0-5V (default)

0-10V

4-20mA

Figure 47. Analog Signal Control Board Setting

To control the pump by an external signal

- 1) Switch the power off. Wire the DB15 connector as shown in [Figure 48](#) or [Figure 49](#), and connect it to the DB15 port on the rear of the pump.

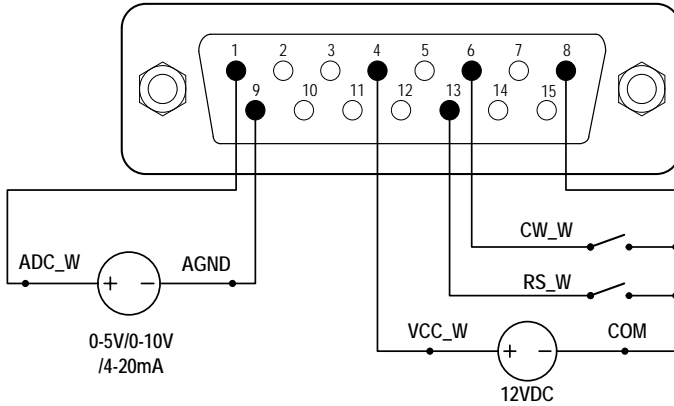

Figure 48. DB15 Wiring with External 12VDC Power Source

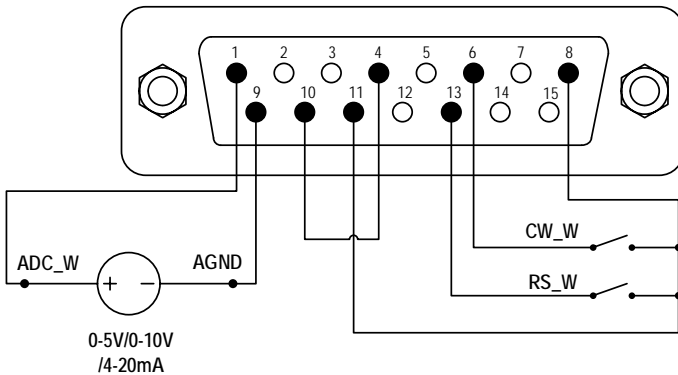





Figure 49. DB15 Wiring with Internal 12VDC Power Source

- 2) Turn on the power switch. The pump will display the main screen.
- 3) Press  to set Control Mode to voltage , or current .
- 4) Turn on the external analog signal power source.
- 5) When set the Remote Control Mode to Logic Level, close the external RS_W switch, the drive will run and the speed will change according to the intensity of the analog input signal. Open the RS_W switch to stop the drive.
When the CW_W switch is open, the drive will run in the clockwise direction; when the CW_W switch is closed, the drive will run in the counterclockwise direction.
- 6) When set the Remote Control Mode to Pulse, close then open the external RS_W switch, the drive will run and the speed will change according to the intensity of the analog input signal. Close and open the RS_W switch again to stop the drive.
When close then open the external CW_W switch, the drive will run in the clockwise direction; when close then open the CW_W switch again, the drive will run in the counterclockwise direction.

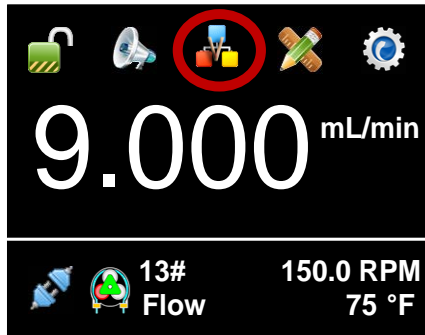

Figure 50. Voltage Control Mode

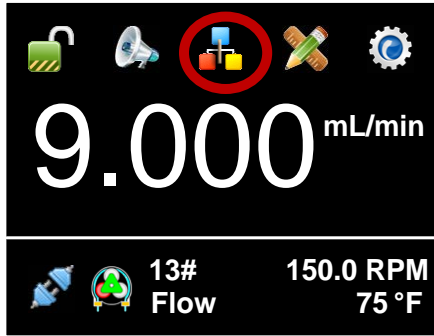

Figure 51. Current Control Mode

Note: The external DC power source can be 5V or 12V. If it is 24V, a 1.5K resistor is needed to protect the internal circuit.

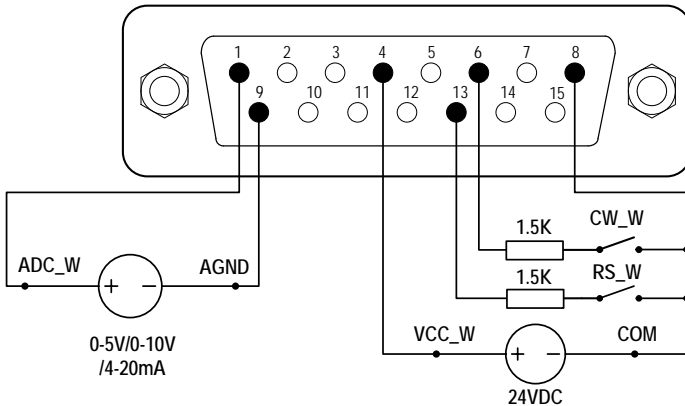

Figure 52. DB15 Wiring with External 24VDC Power Source

7.8 Communication Mode

The RS485 interface supports the standard MODBUS protocol. The pump can communicate with an external device via the communication port. Please refer to the [Communication Instruction manual](#) for the parameters and supported commands.

To work with communication mode

- 1) Turn the power off. Wire the DB15 connector as shown in [Figure 53](#), and connect it to the DB15 port on the rear of the pump. An external DC power source is recommended to avoid electrical interference.

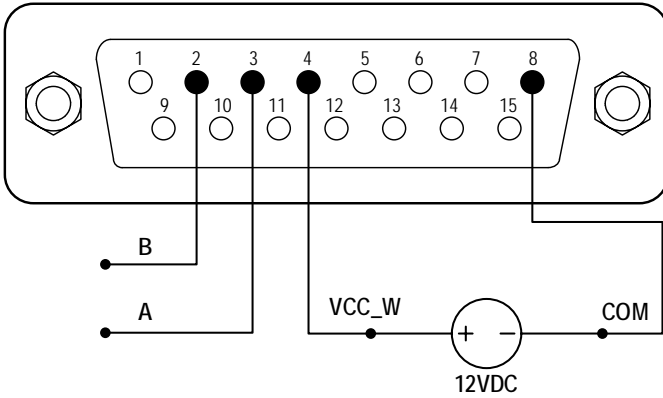



Figure 53. RS485 MODBUS Wiring

- 2) Turn the power on. The pump will display the main screen.
- 3) On Internal Control Mode, when the main screen shows , the communication is connected. If it shows , the communication is disconnected.
- 4) Control pump with the communication interface.

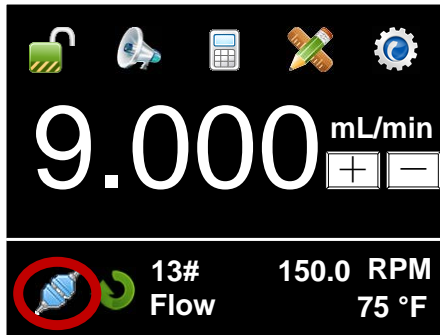

Figure 54. Communication Connected

7.9 Footswitch

To use a footswitch to control the start and stop

- 1) Power pump off. Wire the DB15 connector as shown in Figure 55 or Figure 56, and connect it to the DB15 port on the rear of the pump.

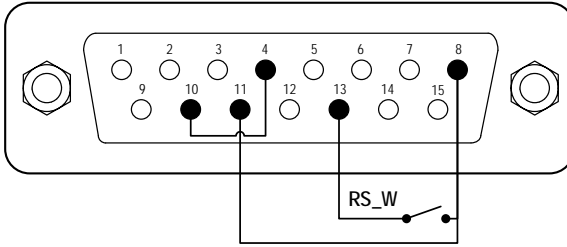

Figure 55. Control Start/Stop with Internal 12V Power Source

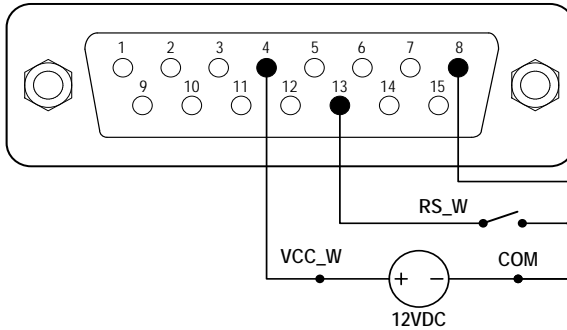

Figure 56. Control Start/Stop with External 12V Power Source

- 2) Turn the power on. The pump will display the main screen.
- 3) In Internal Control Mode, if the pump is set to one of the dispense modes and the switch RS_W is closed and then opened, the pump will start to dispense.
- 4) In Footswitch Control Mode, if Remote Control Mode is set to Logic Level and the switch RS_W is closed, the drive will start; when the switch is open, the drive will stop.
- 5) In Footswitch Control Mode, if Remote Control Mode is set to Pulse and the switch RS_W is closed and then opened, the drive will start. When the switch is closed and then opened again, the drive will stop.

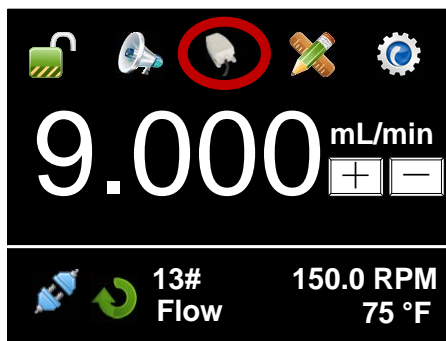

Figure 57. Footswitch Control

8 Maintenance

8.1 Warranty

The product comes with one-year labor and parts warranty. The limited warranty does not cover any damage that is caused by improper usage and handling.

8.2 Regular Maintenance

- 1) Always check the tubing and connections to make sure there is no leakage.
- 2) Do not cover the fan on the rear of the pump.
- 3) Do not use water to wash the pump. Keep pump head dry.
- 4) Do not use chemical solvents to clean the pump and pump head.

8.3 Malfunction Solutions

No	Malfunction	Description	Solution
1	Hardware	No display	<ol style="list-style-type: none"> 1. Check the power cord 2. Check the fuse. If it was blown, replace it with a 1A slow-blow fuse 3. Check the internal power cord connection inside the pump. 4. Check the wire connection between the LCD and the main control board.
2	Hardware	Motor does	<ol style="list-style-type: none"> 1. Check the indicator of the driver

BT-01F Intelligent Dispensing Peristaltic Pump

		not work	board. 2. Check the wire connection between the motor and the driver board. 3. Check the wire connection between the driver and the main board. 4. Check the power voltage for the pump.
3	Hardware	Motor is trembling	1. Check the wire connection between the motor and the driver board. 2. The motor is overloaded. Check the mechanical connection.
4	Hardware	Motor only runs in one direction	Check the connection between the drive board and the main control board.
5	Hardware	Keypad does not work	1. Check the wire connection between the keypad and the main board. 2. Check if the key is broken.
6	Hardware	External control does not work	1. Check the wiring of the connector. 2. Check if the external control power voltage is provided. 3. Check the connections of the external control board.
7	Hardware	RS485 com does not work	1. Check the wiring of the connector. 2. Check if the external control power voltage is provided. 3. Check the connections of the communication board.
8	Hardware	Noisy when running	Check the screws and level on the pump head to make sure they are secure.
9	Software	External control does not work	Check if the pump is on External Control Mode.
10	Software	RS485 does not work right	1. Check if the display shows the communication is ready.

BT-01F Intelligent Dispensing Peristaltic Pump

			<ol style="list-style-type: none">2. Reset the address of the pump.3. Check whether on the bus there are two pumps using the same address
--	--	--	--



If the problem can not be solved, please contact the manufacturer or distributor.

9 Dimensions

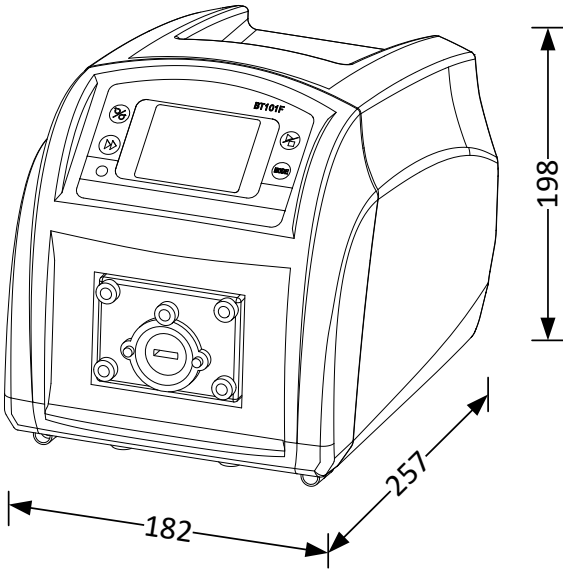
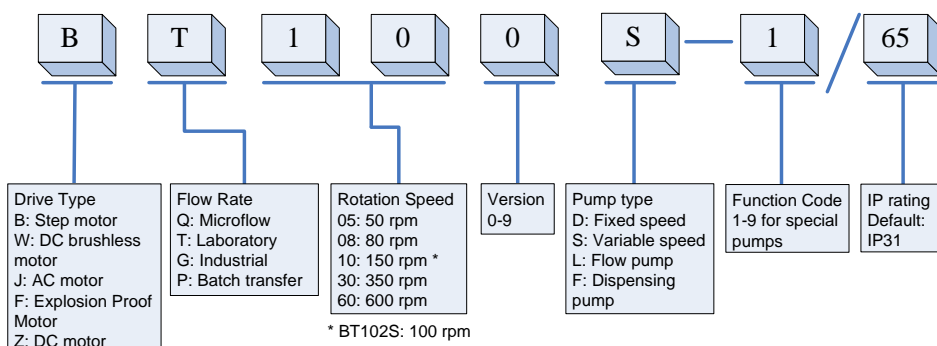

Figure 58. Dimensions (mm)

10 Naming Rule



11 Specifications

Speed resolution	0.1 rpm
Speed accuracy	0.2%
Power supply	AC 100-240V, 50Hz/60Hz;
Power consumption	BT101F: < 30W; BT301F:< 40W; BT601F: < 50W
Logic level control signal	5V, 12V (standard), 24V (optional)
External analog control signal	0-5V (standard); 0-10V, 4-20mA (optional)
Communication interface	RS485 MODBUS
Operating condition	Temperature 0~40°C, Relative humidity <80%
IP grade	IP31
Display	TFT Touch Screen LCD, 65536 Colors
Dimensions (LxWxH)	257 x 182 x 198 mm (10.12 x 7.17 x 7.79 inch)
Weight	BT101F: 4.8 kg (10.6 lbs); BT301F: 5.3 kg (11.7 lbs); BT601F: 5.5 kg (12.1 lbs)

BT101F Suitable Pump Heads and Tubing, Flow Parameters

BT-01F Intelligent Dispensing Peristaltic Pump

Drive type	Pump head	Ch	Tubing size (mm)	Flow rate per channel (mL/min)
BT101F (ABS case)	DG6-1 (6rollers)	1	Wall:0.8~1, ID:≤2.4	0.0002 ~ 49
	DG10-1 (10rollers)	1	Wall:0.8~1, ID:≤2.4	0.0001~41
	DG6-2 (6rollers)	2	Wall:0.8~1, ID:≤2.4	0.0002 ~ 49
	DG10-2 (10rollers)	2	Wall:0.8~1, ID:≤2.4	0.0001~41
	DG6-4 (6rollers)	4	Wall:0.8~1, ID:≤2.4	0.0002 ~ 49
	DG10-4 (10rollers)	4	Wall:0.8~1, ID:≤2.4	0.0001~41
	DT10-18	1	13# 14#, Wall:0.8~1, ID:≤3.17	0.0002~82
	DT10-28	2	13# 14#, Wall:0.8~1, ID:≤3.17	0.0002~82
	YZ15	1	13# 14# 16# 19# 25# 17#	0.0006~420
	YZ25	1	15# 24#	0.16~420
	YT15	1	13# 14# 16# 19# 25# 17# 18#	0.006~570
	YT25	1	15# 24# 35# 36#	0.17~720

BT301F Suitable Pump Heads and Tubing, Flow Parameters

Drive type	Pump head	Ch	Tubing size	Flow rate per channel (mL/min)
	YZ15	1	13# 14# 16# 19# 25# 17#	0.006~990
	YZ25	1	15# 24#	0.16~990

BT-01F Intelligent Dispensing Peristaltic Pump

BT301F (ABS case)	YT15	1	13# 14# 16# 19# 25# 17# 18#	0.006~1300
	YT25	1	15# 24# 35# 36#	0.17~1690

BT601F Suitable Pump Heads and Tubing, Flow Parameters

Drive type	Pump head	Ch	Tubing size	Flow rate per channel (mL/min)
BT601F (ABS case)	YZ15	1	13# 14# 16# 19# 25# 17# 18#	0.006~1700
	YZ25	1	15# 24#	0.16~1700
	YT15	1	13# 14# 16# 19# 25# 17# 18#	0.006~2300
	YT25	1	15# 24# 35# 36#	0.16~2900

Golander LLC

4405 International Blvd
Ste B117, Norcross, GA 30093
USA

Tel: +1 678-587-8806

info@golanderpump.com

www.golanderpump.com

Golander GmbH

Dechant-Heimbach-Str. 29
53177 Bonn
Germany

Tel: +49 228 50446952

info@golander.de

www.golander.de