

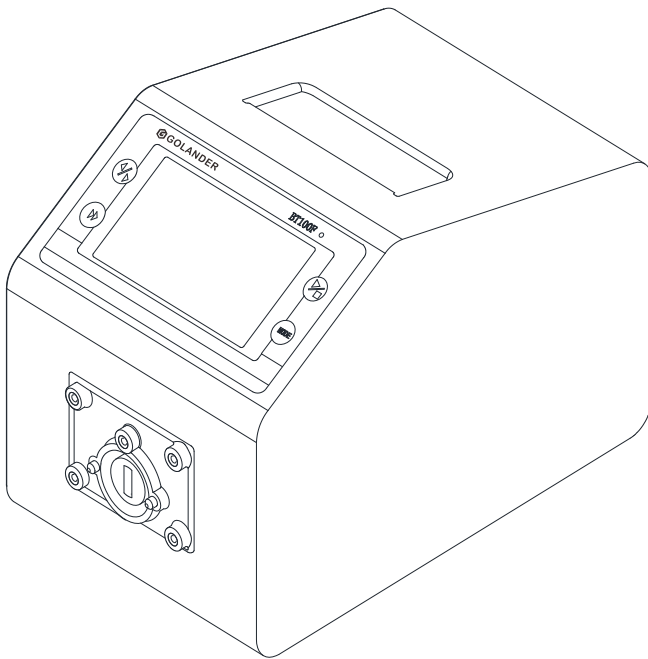

**BT100F/300F/600F**

**Intelligent Dispensing Peristaltic Pump  
Operating Manual**



# Contents

Safety Precautions .....	1
1 Description .....	6
2 Functions and Features.....	6
3 Components and Connectors.....	8
4 Display Panel and Operating Keypad.....	9
4.1 Keypad .....	9
4.2 LCD Touch Screen Display .....	10
4.3 Status bar .....	10
5 Operation zone .....	14
6 Navigation Buttons .....	15
7 External Control Interface.....	25
8 Operation Instructions .....	26
8.1 Before Operation .....	26
8.2 Power Connection .....	26
8.3 First Run Wizard.....	27
8.4 Working Mode .....	29
8.5 External Control Mode .....	34
8.6 Communication mode .....	36
8.7 Footswitch .....	38
9 Maintenance .....	40
9.1 Warranty.....	40
9.2 Regular Maintenance .....	40
9.3 Malfunction Solutions .....	40
10 Dimensions.....	42
11 Naming Rule .....	42
12 Specifications .....	43

## Safety Precautions



### Danger

- Use the correct voltage indicated on the rating plate label of the pump to avoid any damage.
- Do not make any unauthorized dismantling, changes or modifications to the pump which could result in malfunctions or even potential accidents.
- Turn off the pump drive before installing or removing tubing, attempting any maintenance, cleaning or repair of the drive, connecting or disconnecting external control devices or a communication interface. Fingers or loose clothing could get caught in the drive mechanism.



### Warning

- Ensure no chemical reactions occur between the handled fluid with the material of the pump head and tubing before use.
- Tubing should be checked regularly to avoid breakage. Tubing breakage may result in fluid being sprayed from the pump. Use appropriate measures to protect the operator and equipment. The operator is solely liable for damages resulting from tubing breakage, particularly the leakage of toxic or valuable liquids.
- The pump is provided with a grounded plug which must be well grounded at all times.
- This device is not designed for nor intended for usage in patient connected applications, including but not limited to medical and dental use.
- Observe all other applicable regulations concerning working safety, operational safety, environmental protection and relevant local regulations.

**(DE) SICHERHEITSHINWEISE****Gefahr**

- Verwenden Sie die richtige Spannung, die auf dem Typenschild der Pumpe angegeben ist, um Schäden zu vermeiden.
- Nehmen Sie keine unbefugten Demontagen, Änderungen oder Modifikationen an der Pumpe vor, die zu Fehlfunktionen oder sogar zu Unfällen führen könnten.
- Schalten Sie den Pumpenantrieb aus, bevor Sie Schläuche ein- oder ausbauen, Wartungs-, Reinigungs- oder Reparaturarbeiten am Antrieb vornehmen oder externe Steuergeräte oder eine Kommunikationsschnittstelle anschließen oder trennen. Finger oder lose Kleidungsstücke können sich im Antriebsmechanismus verfangen.

**Warnung**

- Vergewissern Sie sich vor der Verwendung, dass keine chemischen Reaktionen zwischen dem Fördermedium und dem Material des Pumpenkopfs und der Schläuche auftreten können.
- Die Schläuche sollten regelmäßig überprüft werden, um Brüche zu vermeiden. Ein Schlauchbruch kann dazu führen, dass Flüssigkeit aus der Pumpe spritzt. Ergreifen Sie geeignete Maßnahmen zum Schutz des Bedieners und der Ausrüstung. Der Betreiber haftet allein für Schäden, die durch einen Schlauchbruch entstehen, insbesondere für das Austreten von giftigen oder wertvollen Flüssigkeiten.
- Die Pumpe ist mit einem geerdeten Stecker ausgestattet, der stets korrekt an eine abgesicherte Netzsteckdose angeschlossen sein muss. Dieses Gerät ist nicht für Anwendungen ausgelegt oder vorgesehen, die im Zusammenhang mit der Behandlung von Patienten stehen. Medizinische bzw. zahnmedizinische Anwendungen sind nicht bestimmungsgemäß.
- Beachten Sie alle anderen geltenden Vorschriften zur Arbeitssicherheit, zur Betriebssicherheit, zum Umweltschutz sowie die einschlägigen örtlichen Vorschriften.

**(FR) CONSIGNES DE SÉCURITÉ****Danger**

- Utilisez la tension correcte indiquée sur la plaque signalétique de la pompe afin d'éviter tout dommage.
- Ne procédez pas à des démontages, changements ou modifications non autorisés de la pompe qui pourraient entraîner des dysfonctionnements, voire des accidents.
- Mettez l'entraînement de la pompe hors tension avant d'installer ou de retirer des tuyaux, d'effectuer des travaux d'entretien, de nettoyage ou de réparation sur l'entraînement ou de connecter ou déconnecter des dispositifs de commande externes ou une interface de communication. Des doigts ou des vêtements lâches pourraient se prendre dans le mécanisme d'entraînement.

**Avertissement**

- Avant toute utilisation, assurez-vous qu'il n'y a pas de réaction chimique entre le liquide pompé et le matériau de la tête de pompe et des tubes.
- Les tuyaux doivent être contrôlés régulièrement pour éviter les ruptures. Une rupture de tuyau peut entraîner des projections de liquide hors de la pompe. Prenez les mesures appropriées pour protéger l'opérateur et l'équipement. L'opérateur est seul responsable des dommages causés par une rupture de tuyau, notamment en cas de fuite de liquides toxiques ou précieux.
- La pompe est équipée d'une fiche de mise à la terre qui doit toujours être bien reliée à la terre.
- Cet appareil n'est pas conçu ni prévu pour être utilisé en présence de patients, y compris, mais sans s'y limiter, dans le cadre d'applications médicales et dentaires.
- Respectez toutes les autres réglementations applicables en matière de sécurité du travail, de sécurité d'exploitation, de protection de l'environnement.

**(ES) INSTRUCCIONES DE SEGURIDAD****Peligro**

- Utilice la tensión correcta indicada en la placa de características de la bomba para evitar daños.
- No realice ningún desmontaje, cambio o modificación no autorizada en la bomba que pueda provocar un mal funcionamiento o incluso accidentes.
- Desconecte el accionamiento de la bomba antes de instalar o retirar las mangueras, realizar trabajos de mantenimiento, limpieza o reparación en el accionamiento o conectar o desconectar dispositivos de control externos o una interfaz de comunicación. Los dedos o la ropa suelta podrían quedar atrapados en el mecanismo de accionamiento.

**Advertencia**

- Antes de usarla, asegúrese de que no hay reacciones químicas entre el medio bombeado y el material de la cabeza de la bomba y las mangueras.
- Las mangueras deben ser revisadas regularmente para evitar roturas. La rotura de una manguera puede hacer que salga líquido de la bomba. Tome las medidas adecuadas para proteger al operador y al equipo. El operador es el único responsable de los daños causados por la rotura de una manguera, especialmente por la fuga de líquidos tóxicos o valiosos.
- La bomba está equipada con un enchufe con toma de tierra que debe estar siempre bien conectado a tierra.
- Este aparato no está diseñado ni pensado para su uso en relación con los pacientes, incluyendo pero sin limitarse a las aplicaciones médicas y dentales.
- Respetar todas las demás normas aplicables en materia de seguridad laboral, seguridad operativa y protección del medio ambiente.

**(IT) ISTRUZIONI DI SICUREZZA****Pericolo**

- Usare la tensione corretta indicata sull'etichetta della targhetta della pompa per evitare qualsiasi danno.
- Non eseguire smontaggi, cambiamenti o modifiche non autorizzati alla pompa che potrebbero causare malfunzionamenti o addirittura potenziali incidenti.
- Spegnerne l'azionamento della pompa prima d'installare o rimuovere tubi, tentare qualsiasi manutenzione, pulizia o riparazione dell'azionamento, collegare o scollegare dispositivi di controllo esterni o un'interfaccia di comunicazione. Dita o indumenti larghi potrebbero rimanere impigliati nel meccanismo di azionamento.

**Attenzione**

- Assicurarsi che non si verifichino reazioni chimiche tra il fluido trattato e il materiale della testa della pompa e dei tubi prima dell'uso.
- I tubi devono essere controllati regolarmente per evitare rotture. La rottura del tubo può provocare spruzzi di fluido dalla pompa. Utilizzare misure appropriate per proteggere l'operatore e l'attrezzatura. L'operatore è l'unico responsabile dei danni derivanti dalla rottura dei tubi, in particolare della fuoriuscita di liquidi tossici o preziosi.
- La pompa è dotata di una spina con messa a terra che deve essere sempre ben collegata a terra.
- Questo dispositivo non è progettato né destinato all'uso in applicazioni collegate al paziente, incluso ma non limitato all'uso medico e dentistico.
- Osservare tutte le altre norme applicabili riguardanti la sicurezza sul lavoro, la sicurezza operativa, la protezione dell'ambiente e le norme locali pertinenti.

# 1 Description

BT-F series of intelligent dispensing peristaltic pumps are designed for precise metering and quantitative dispensing of liquids and to realize high-precision flow transmission. The latest version of this series adopted a larger true color LCD touch screen to improve the ease of use and to allow a more comprehensive information display. The new loop dispense mode enables more complex experimental processes by customising the cycle control process to meet different experimental requirements. More settings were added to the RS485 MODBUS interface for more effective communication with external devices.

BT-F series includes

- BT100F, flow rate: 0.00011-720 mL/min, speed: 0.1-150 rpm
- BT300F, flow rate: 0.006-1600 mL/min, speed: 0.1-350 rpm
- BT600F, flow rate: 0.006-2900 mL/min, speed: 0.1-600 rpm

# 2 Functions and Features

Peristaltic pumps can handle fluid that is particularly abrasive, corrosive or viscous. There are no seals in contact with the medium pumped and no valves to clog. The inner surfaces are smooth and easy to clean. The fluid contacts only the tubing or tube material. Suction lift and priming can be up to 8m water column at sea level. It can handle the most shear sensitive of fluids like latex or firefighting foam with low shearing. It is capable of running dry and pumping fluids with high quantities of entrained air, such as black liquor soap. The high volumetric efficiency allows operation in metering or dosing applications where high accuracy is required. Tubing and tube materials are available for food and pharmaceutical use.

- Color LCD display, touch screen and operating keypad.
- Reversible direction, start/stop control and adjustable speed.
- 0.2% high precision rotating speed control with 0.1 rpm speed



- Flow display and calibration.
- Three dispense modes: Time Dispense Mode, Volume Dispense Mode, Loop Dispense Mode.
- Store 5 groups of working parameters for 4 work modes (flow mode and three dispense modes)
- Store 30 groups of working parameters for loop dispense mode
- Intelligent temperature control
- WIFI function (optional)
- An external logic level signal can control start/stop, direction and easy dispense functions; an external analog signal can adjust the rotating speed. The signal is optically isolated.
- With the RS485 MODBUS interface, the pump can be easily controlled by external devices.
- Internal double-deck isolation structure; circuit board with conformal coating for dust- and moisture-proof.
- Anti-electromagnetic interference feature and wide input voltage range for complex power environment.
- Stainless steel enclosure, easy to clean, resistant to the corrosion of the acid, alkali, sodium and organic solvents.

### 3 Components and Connectors

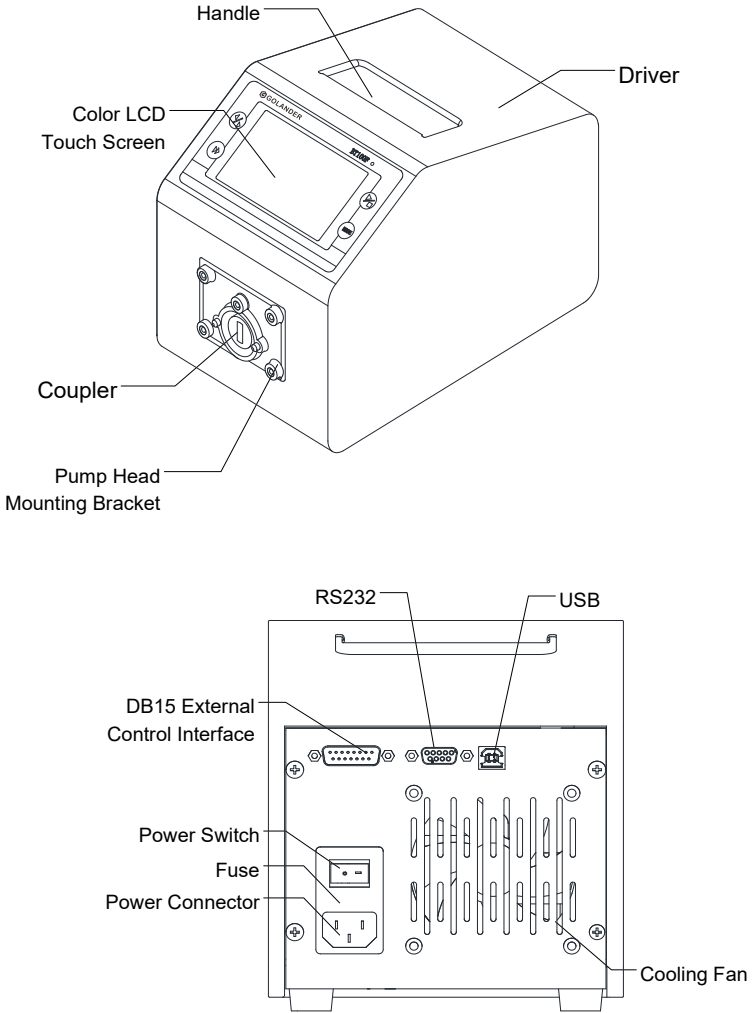

Figure 1. Components and Connectors

## 4 Display Panel and Operating Keypad

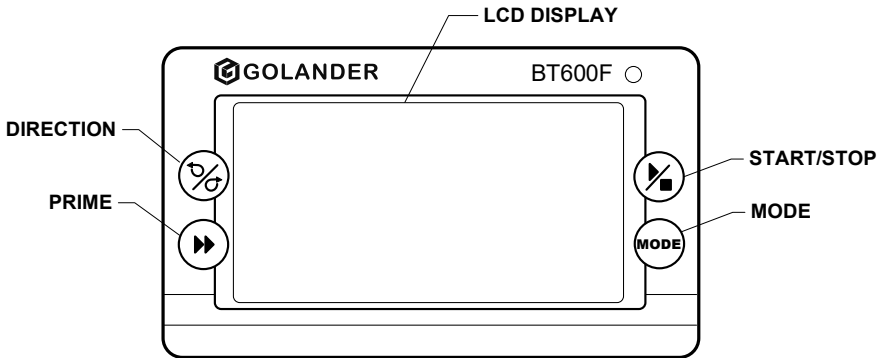





Figure 2. Display Panel

### 4.1 Keypad

-  **START/STOP** key. Press to start or stop the pump.
-  **DIRECTION** Key. Press to change the drive's rotating direction, clockwise or counterclockwise.
-  **PRIME** key. Press the key to run the pump at full speed. Press it again to return to the previous state.
-  **MODE** key. When the pump is not running, use the MODE key to change the working mode. Use the MODE key to change the display content when the keypad is locked.

## 4.2 LCD Touch Screen Display

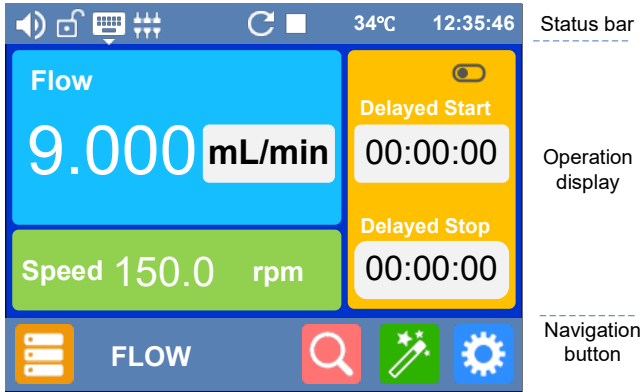

Figure 3. Main screen

## 4.3 Status bar

### A. Tone.

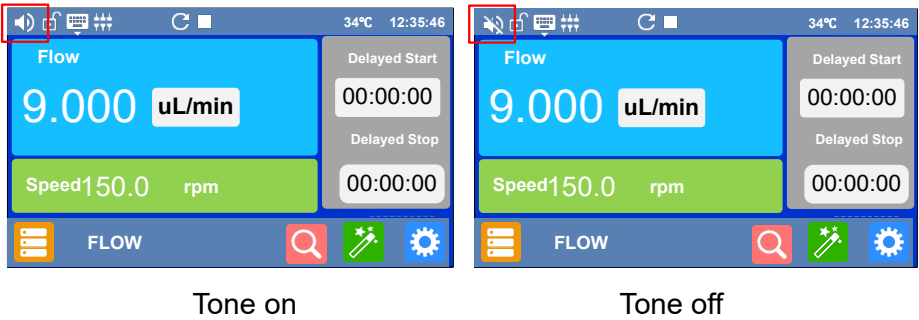
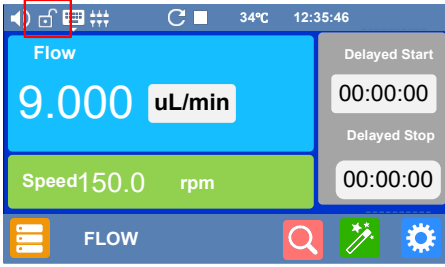
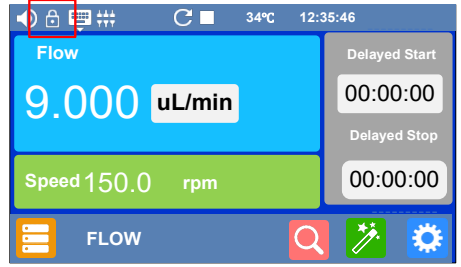

Figure 4 Key Tone

B. Keypad Lock. When the keypad is locked, the control mode and system parameter settings cannot be changed.



Keypad unlocked



Keypad locked

Figure 5 Keypad Lock

C. Control Modes.

Internal Control Mode: The pump is controlled by the keypad and touch screen.

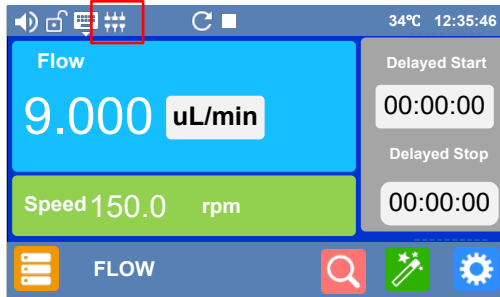

Figure 6 Internal Control Mode

Footswitch Control Mode. A footswitch controls the start/up, while the keypad and touch screen control other parameters.

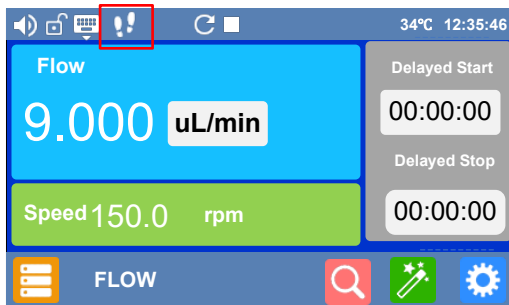
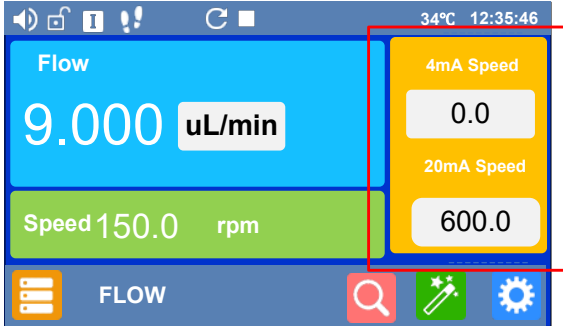

Figure 7 Footswitch Control Mode

**Current Control Mode:** An external 4-20mA analog current signal controls the flow rate. An external logic level signal controls the start/stop. The keypad is disabled.



*Figure 8 Current Control Mode*

**Voltage Control Mode 0-5V:** An external 0-5V analog voltage signal controls the flow rate. An external logic level signal controls the start/stop and direction. The keypad is disabled.

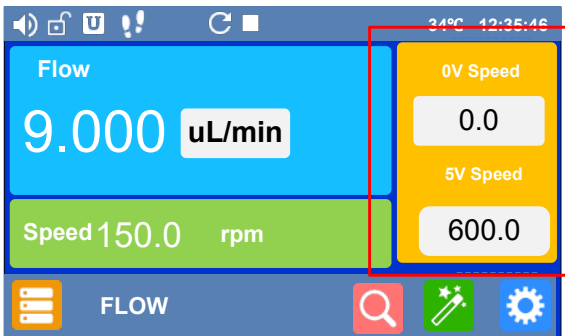

*Figure 9 0-5V Voltage Control Mode*

**Voltage Control Mode 0-10V:** An external 0-10V analog voltage signal controls flow rate. External logic level signal controls the start/stop and direction. The keypad is disabled.

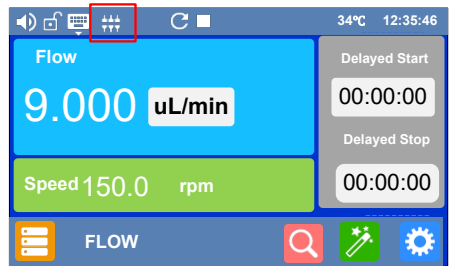

Figure 10 0-10V Voltage Control Mode

D. Communication State.



Communication Connected



Communication Disconnected

Figure 11 Communication State

E. Rotation Direction. When the pump is not running, one of the following icons is displayed.



Clockwise



Counterclockwise

Figure 12 Direction State

F. When the pump is running, an animation will be displayed as shown

below for clockwise rotation.

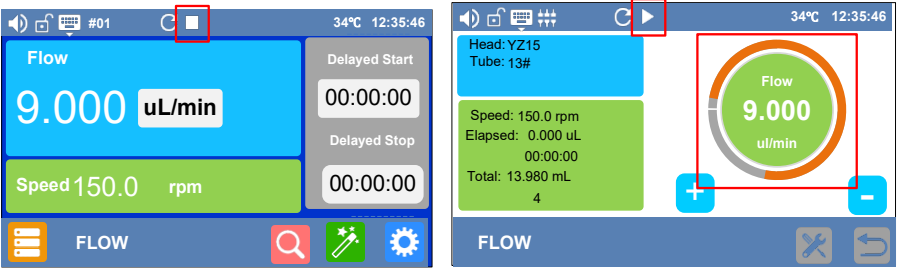

Figure 13 Running Animation

- G. Temperature display: display the current temperature of the driver, such as 34 °C.
- H. Time display: display the current time, such as 12:35:46.

## 5 Operation zone

- A. Parameters settings: When the pump is not running, press it to input desired value in the pop-up window. Please pay attention to the range of the value and flow rate unit.

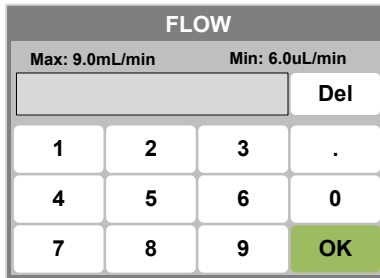

Figure 14 Flow Rate Setting

- B. The Unit Settings. When the pump is not running, press it to change the unit. The allowed units are  $\mu$ L/min, mL/min, and L/min, as shown in Figure 15.



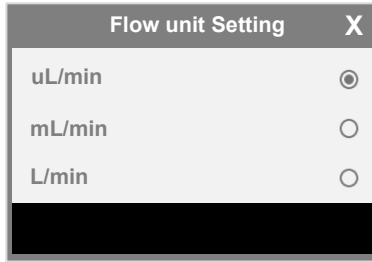
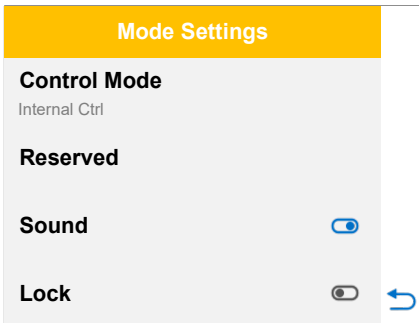

Figure 15 Choose Flow Rate Unit

## 6 Navigation Buttons



**Mode Settings** - Set specifics for different operating modes, including tone on/off and lock on/off.



Flow Mode

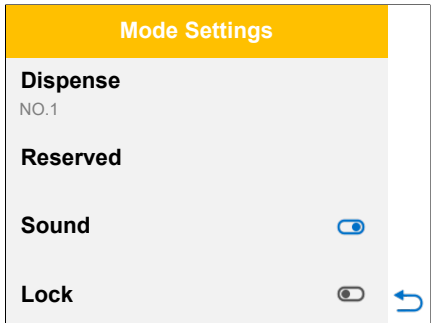

Volume Dispense Mode and  
Time Dispense Mode

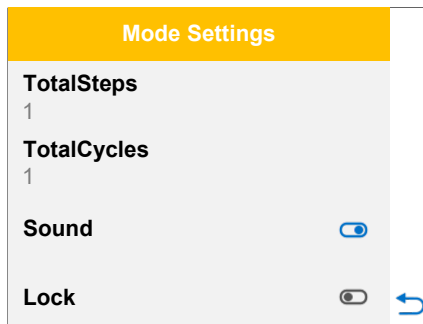

Loop Dispense Mode

Figure 16 Mode setting



**Preview mode** - View running status and parameter changes. The current running parameters display on the left side of the interface, while the running status is shown on the right side.

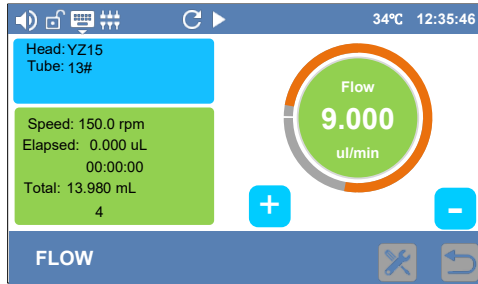

*Figure 17 Preview Interface*

Regardless of whether the peristaltic pump is running or not, the flow rate can be adjusted in real time by pressing the plus or the minus icon shortly to increase or decrease the flow rate. Press and hold an icon to change the value quickly.



Increase



Decrease

*Figure 18 Fine Adjustment Button*

In the flow mode, red in the center indicates stop, green indicates in operating, and the current flow is displayed in the middle.

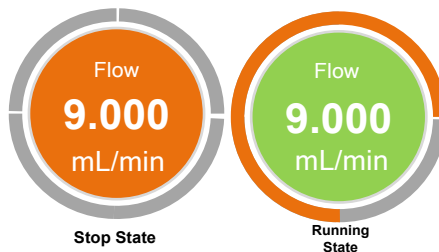

*Figure 19 Running Status Display*

The rotating ring shows the direction in which the pump operates.

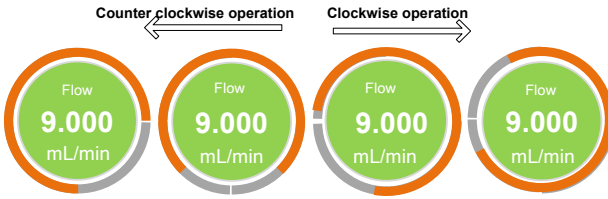

Figure 20 Direction Indication

In the dispense mode, red in the center means stop, green means in operation, and yellow means pause.



Figure 21 Dispense Status Indication



**Quick Settings** - Clear accumulative volume and accumulative cycles, tone on/off, and lock on/off.

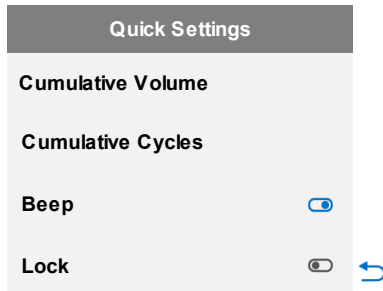

Figure 22 Quick Settings



**Calibrate** - Following the wizard prompts, the transferred liquid is weighed by means of a balance or measuring cylinder so that the displayed value corresponds precisely to the actual flow rate.

Note: If an accurate display of the flow rate is required, a flow rate calibration must be carried out.



**System Menu** - When the pump is not running, press the icon to enter the System Menu.

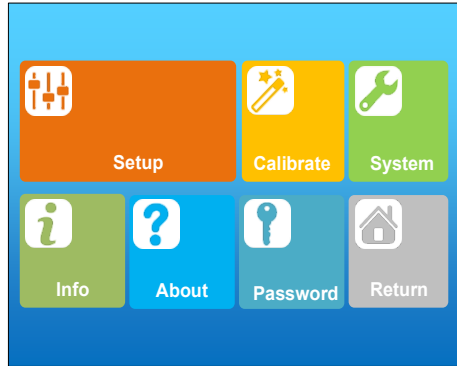

Figure 23 System Menu

**Setup** - To set up the general settings, swipe up and down to view the menu, details as in Figure 24.

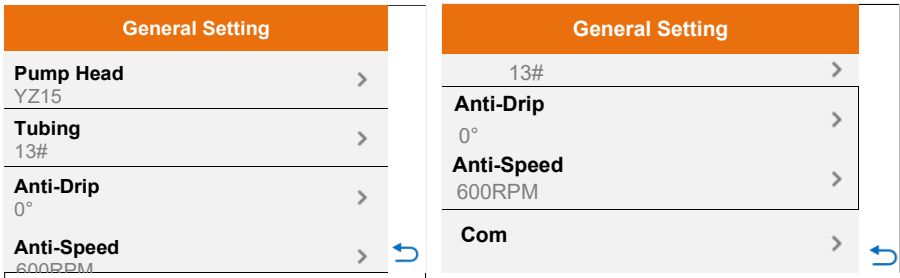

Figure 24 General Settings

- **Pump Head:** Choose the model of the installed pump head and swipe up and down to view the menu, as shown in Figure 25.

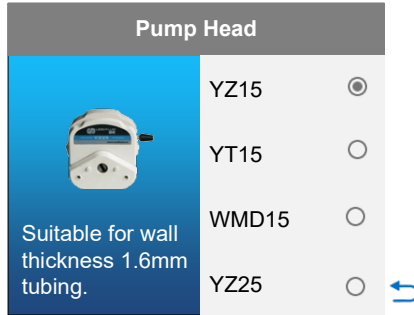

Figure 25 Pump Head Selection

- Tube Settings:** Choose the appropriate tubing size for the selected pump head. Swipe up and down to view the menu, as shown in Figure 26.

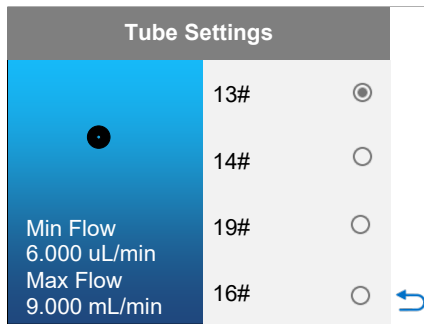

Figure 26 Tubing Selection

- Anti-drip Settings:** The peristaltic pump will rotate the set angle reversely to prevent fluid from dripping from the tubing when the peristaltic pump stops. To set the back suction angle, you can select the following options or custom input values. When the angle is set to 0, this function is disabled.

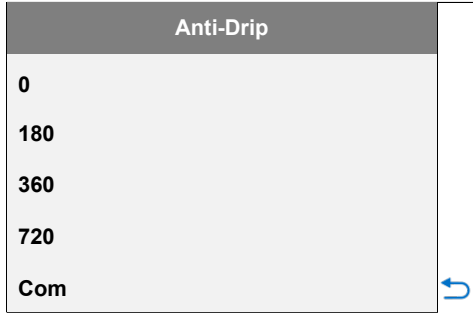

Figure 27 Anti-drip Settings

- **Anti-speed:** Set the reverse speed as needed.

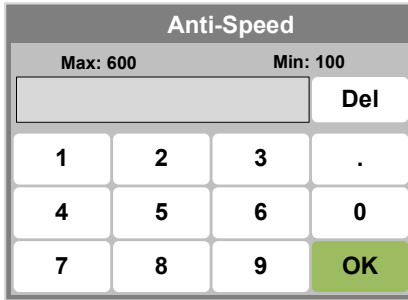

Figure 28 Anti-Speed Setting

- **Communication settings** - Sets the parameters of RS485 communication, as shown in Figure 29.

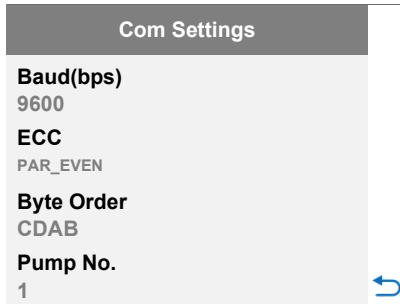

Figure 29 Communication Settings

When a password is set and entered (default password is blank), more parameter settings in general settings will be displayed. Please swipe up

and down to view the menu.

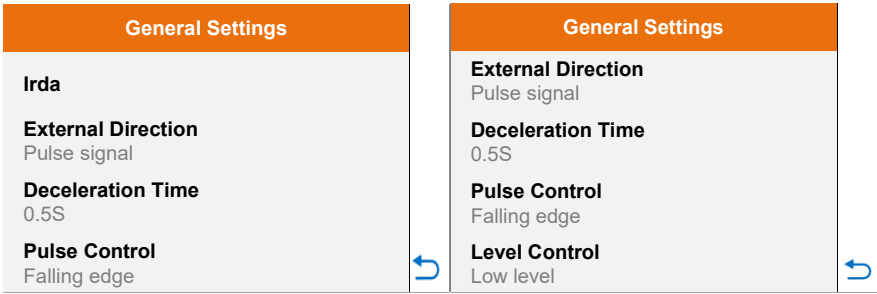

Figure 30 General Settings (Advanced)

- **External Direction:** Select the external signal type to control the direction: level or pulse. When it is set to Level, the direction will change when an external signal is closed or open, like working with a maintained switch. When it is set to Pulse, the direction will change when the signal is closed and then open again, like working with a normally-open momentary switch.
- **Deceleration Time:** It is the time for the drive to stop from the running speed to 0. This setting is to reduce fluid splash at the end of a dispense.
- **Pulse Control:** When the external direction signal is a pulse signal, a falling or rising edge is set to change the direction. A falling edge is an edge that changes from a high to a low level, and a rising edge is an edge that changes from a low level to a high level.

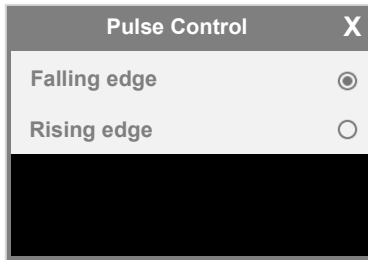

Figure 31 Pulse Signal

- **Level signal:** When the external control signal is a level signal, setting a low or high level to change the direction.



Figure 32 Level Signal

**Calibrate wizard** - In order to improve the flow accuracy of liquid delivery, it is necessary to calibrate the flow rate. According to the wizard prompts, measure the delivered liquid using a balance or a measuring cylinder to make the display value correspond to the actual flow accurately.

**Note:** Flow rate calibration must be performed for accurate flow display.

**System setting** - To set the system parameters of the pump, one can swipe up and down the screen to view the menu, as shown below.

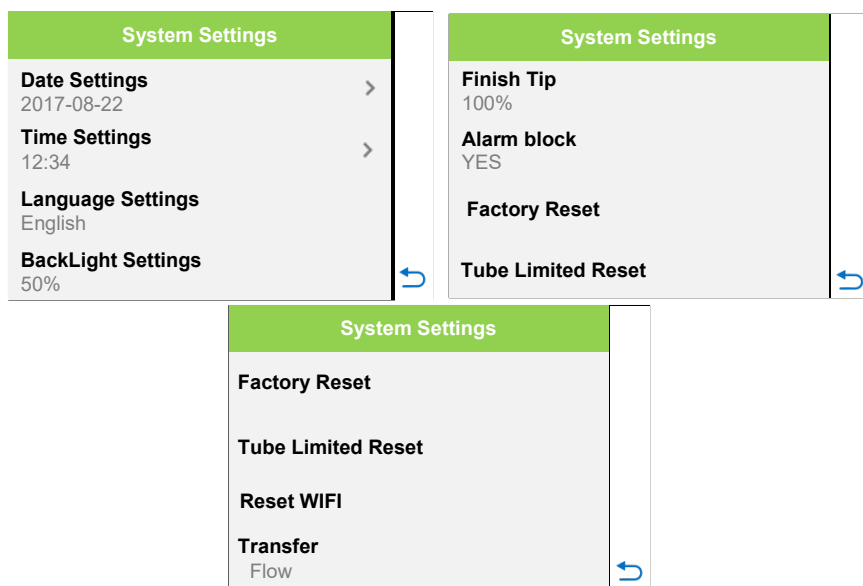

Figure 33 System Settings

- **Date:** Set the current year, month and day.



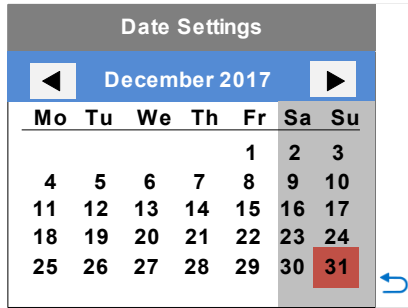

Figure 34 Date Setting

- **Time:** Set Hour, Minute and Seconds by using the UP and DOWN buttons.

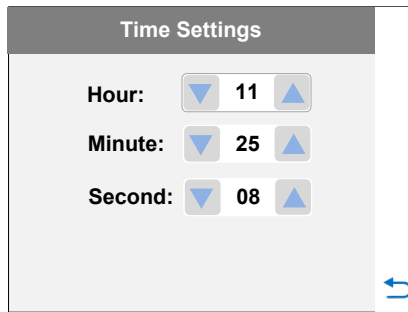

Figure 35 Time Setting

- **Language:** Choose the display language, Chinese or English



Figure 36 Language

- **Factory Reset:** It is to reset the pump to factory settings. Restart the pump to apply the settings. Users can also reset the pump by



pressing and holding the direction key  and mode key  when powering up the pump. Release the keys after a beep.



Figure 37 Factory Reset

- **Transfer mode:** selection of the Flow mode, Time Dispense mode, Volume Dispense mode or Loop Dispense mode.

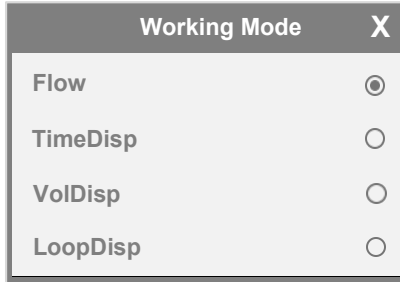

Figure 38 Working Mode

**Info** - To view the information about the usage of the peristaltic pump.

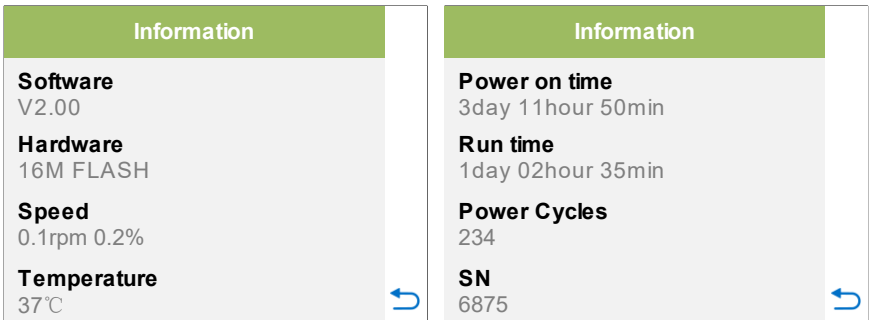

Figure 39 Information

**Password-** Set a password to prevent users from modifying the system settings. The default password is blank.

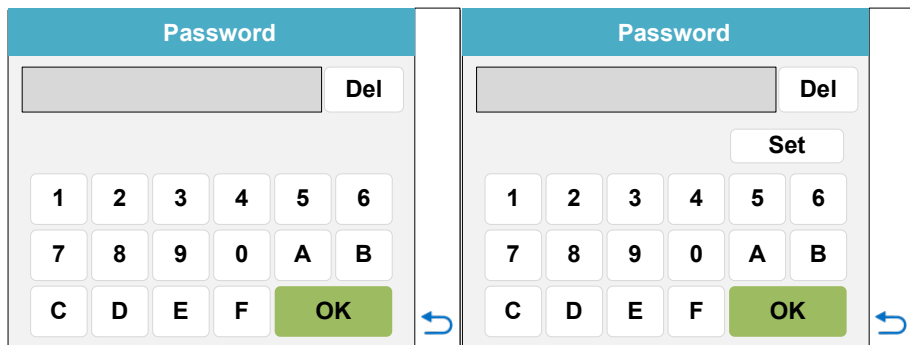
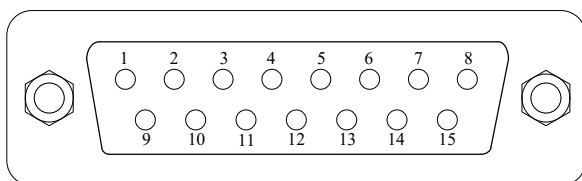

Figure 40 Password Setting

**Return-** Return to the main screen.

## 7 External Control Interface



DB15	Mark	Note
1	ADC_W	Positive of external analog input
2	B	Communication interface, B pole of RS485
3	A	Communication interface, A pole of RS485
4	VCC_W	External DC power input
5	DAC	Analog voltage signal output
6	CW_W	External input signal to control the direction
7	PWM	Pulse signal output
8	COM	Ground of external power
9	AGND	Negative of analog signal input
10	+12V	Positive of internal +12V power source
11	GND	Ground of internal power source
12	CW	Direction signal output
13	RS_W	External start/stop signal input
14	PWM_W	External pulse signal input
15	RS	Internal start/stop signal output

Table 1 External Control Definition

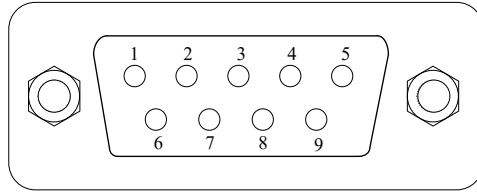

No. DB9	Mark	Note
1		
2	RXD	Receiving data
3	TXD	Send data
4		
5	GND	Signal ground line
6		
7		
8		
9		

Table 2 RS232 definition

## 8 Operation Instructions

### 8.1 Before Operation

- 1) Please check the packing slip to ensure all parts are included and intact in the package. If there is a problem, please contact the manufacturer or distributor.
- 2) Read the instructions.
- 3) At least 200 mm space from the back of the pump should be maintained when in operation.

### 8.2 Power Connection

The voltage of the power supply should match what is indicated on the rating plate label of the pump. Plug the power cord into the IEC Power Connector on the rear of the pump and plug the opposite end of the power cord into an electrical outlet. Flip the power switch on the rear of the pump.

## 8.3 First Run Wizard

### Flow Rate Calibration

Calibrate the flow rate by measuring the transferred liquid using a balance or a measuring cylinder, when

- First time using the pump
- The pump head is changed
- Tubing is installed or replaced
- Transfer fluid in one channel with dual pump heads
- After a long period of continuous operation

#### To calibrate the flow rate

- 1) Install the pump head and tubing.
- 2) Select the model of the installed pump head and tubing in the General Settings window.
- 3) Press the prime key to fill the tubing with liquid.
- 4) When the pump is not running, press  or choose the “Calibrate” icon under System Menu.
- 5) On the calibration wizard screen, the system shows the calibration of currently selected tubing, flow rate and fluid volume.

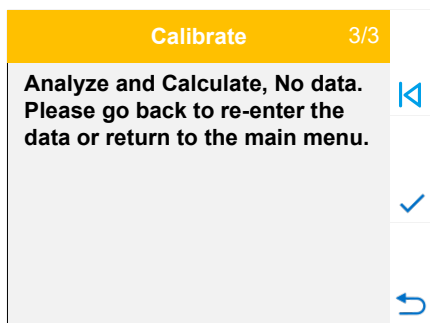



Figure 41 Flow Rate Calibration

The flow rate 9.000 mL/min is the desired flow rate, and 6.000 mL is the minimum fluid volume for testing. The values or the units can be changed directly by pressing the button. Press the  to enter the calibration window, or press the  to exit the wizard.

**Note:** The fluid volume should not be less than the suggested value.

6) The test window is shown below.

The screenshot shows a 'Calibrate' screen with a yellow header bar containing a square icon, a circular arrow icon, the text 'Calibrate', and '2/3'. Below the header, the text reads 'Press START/STOP key to test, then input the data.' To the right of this text are navigation arrows: a left arrow, a right arrow, and a refresh arrow. Below the text are three test input sections: 'Test1:', 'Test2:', and 'Test3:'. Each section contains a numeric input field with '0.000' and a unit selection dropdown menu with 'mL' selected.

*Figure 42 Calibration*

Pressing the Start/Stop key, the pump will start to transfer fluid. Wait for the pump to finish testing, and then measure the delivered volume. Repeat the above steps a couple more times, and enter the results of Test1, Test2 and Test3 in the calibration window. Please make sure that the unit is correct, then press **▶** to enter the Calibrate Calculate screen. If you want to modify the test value of flow rate and volume, press the **◀** and re-enter the value. Press the **↻** to exit the calibrate wizard interface and return to the system parameter interface. After entering one or multiple sets of testing data, the system will calculate the average value automatically.

**Note:** If an undesired situation occurs during the test, please press the Start/Stop key to stop the test. Press the START/STOP key again to retest.

7) The calibration testing result will be calculated and the old value is also displayed on the screen for reference. The new value and the old value would be different. When the ratio of new to old value is less than 0.5 or higher than 2, please check the following:

- The accuracy of the volume measurement
- The volume unit setting
- The model of the pump head setting

- The tubing size setting
- The liquid viscosity. When it is too high, the flow rate may not be linear to the speed.
- If dual pump heads are used for one channel

If there are no problems, press the ✓ to save the new value. Otherwise, press the ⏪ to retest. Or, press the ↶ to exit without saving the new value and return to the System settings window.

Calibrate		3/3
<b>Analyze and Calculate the specific data are as follows:</b>		⏪
Average	3.000 mL	
Cal scale	213.333	
Re scale	106.667	✓
Old scale	106.667	
		↶

Figure 43 Calibrate Result

If no data was entered into the system, the window below will be displayed. Please press ⏪ to test again.

Calibrate		3/3
<b>Analyze and Calculate, No data. Please go back to re-enter the data or return to the main menu.</b>		⏪
		✓
		↶

Figure 44 No Data Entered

## 8.4 Working Mode

When the pump is not running, press the MODE key to enter the Working Mode window as shown below.

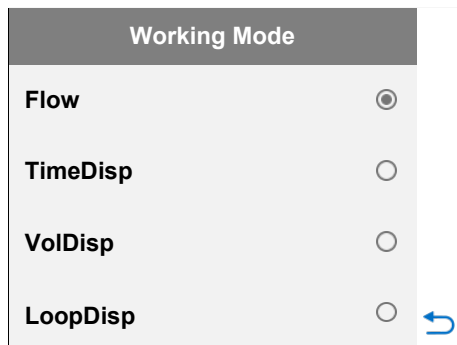

Figure 45 Working Mode

- **Flow Mode**

The pump will run according to the set flow rate and record the cumulative fluid volume.

In the main screen, the flow and flow unit can be set and the flow rate can be changed. In the preview screen, the model of the pump head, tube size, current operating time and liquid volume is displayed. Fine adjustments to the flow rate can be made by using the increase and decrease icons.

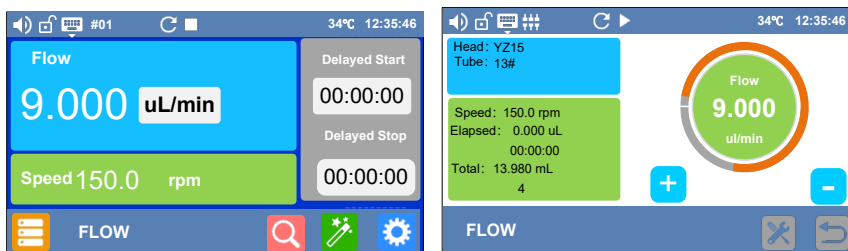

Figure 46 Flow Interface

In the flow mode, delayed start and delayed stop can be customized in pop-up windows. Figure 47 shows the setting for an automatic start in 10 hours and 30 minutes and an automatic stop after 2 hours and 15 minutes of operation.





Figure 47 Delay Time Settings

After setting the time, press the START/STOP key to start the delay process. An alarm icon will appear in the status bar, as shown below.

**Note:** If the delay stop time is set to 0, the delay process cannot be started.

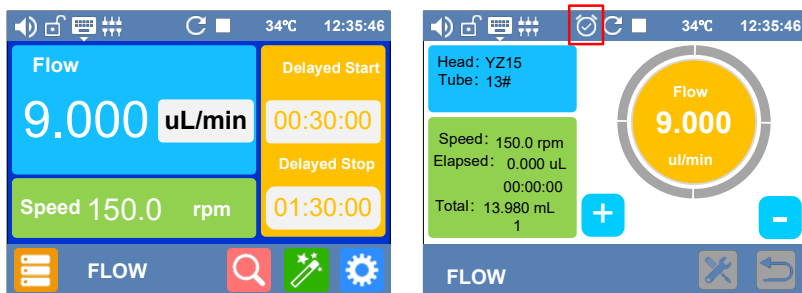

Figure 48 Alarm Icon on the Status Bar

- **Volume Dispense Mode**

The pump will dispense by setting the dispense volume for each dose, pause time between doses and the number of cycles. The system will calculate the duration time for each dose automatically.

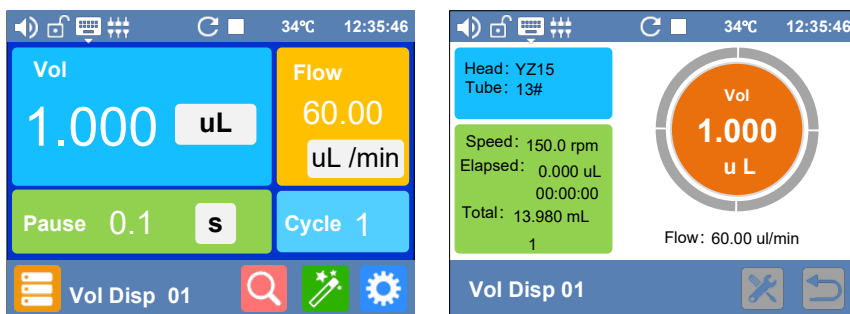

Figure 49 Volume Dispense Mode

The main interface parameters can be set as follows:

A - Dispense volume for each dose,  $\mu\text{L}$ , mL or L.

B - Dispense flow rate,  $\mu\text{L}/\text{min}$  or  $\text{mL}/\text{min}$ .

C – Pause time. The time between doses.

D - Dispense cycles. When the dispense cycle is set to zero, the pump will keep running until the START/STOP key is pressed. When the dispense cycle is set to 1, the pump will run only once, and the pause time setting is invalid. When the dispense cycle is set to more than 1, the pump will run the set number of cycles and then stop.

The preview interface shows the current pump head, tubing size, cycles and the time it has run.

The current setting will be saved under the “Vol Disp 01” group. To recall a different group of settings, press , select a group number in the window, and then return to the dispense mode window. If you change the settings, the setting will be saved to the current group. There are 5 groups available to use.

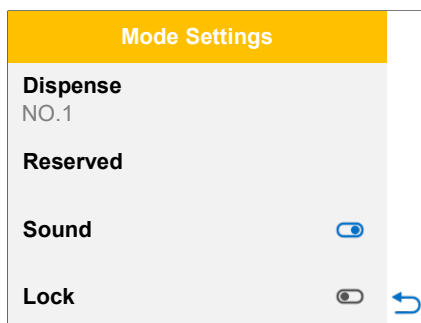

- **Time Dispense Mode**

The pump will dispense by setting the dispense duration for each dose, pause time between doses and number of cycles. The system will calculate the dispense volume for each dose automatically.

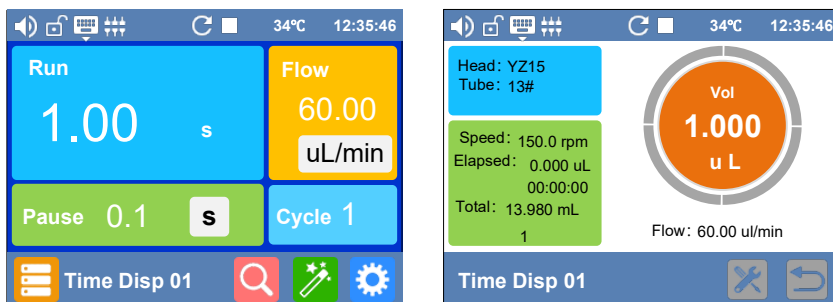

Figure 50 Time Dispense Mode

A - Dispense duration for each dose

B - Dispense flow rate, mL/min or L/min.

C - Pause time. The time between doses.

D - Dispense cycles. When the dispense cycle is set to zero, the pump will keep running until the START/STOP key is pressed. When the dispense cycle is set to 1, the pump will run only once, and the pause time setting is invalid. When the dispense cycle is set to more than 1, the pump will run the set number of cycles and then stop.

The preview interface shows the current pump head, tubing size, the cycles run and the volume transferred.

The current setting will be saved to the “Time Disp 01” group. To recall a different group of settings, press , select a group number in the window, and then return to the dispense mode window. If you change the settings, the setting will be saved to the current group. There are 5 groups available to use.

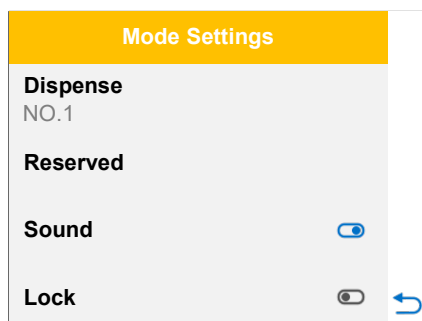

- Loop dispense mode

By setting the operating steps and the number of cycles for each step, the pump automatically completes dispensing following the steps. Thirty steps are available with volume, flow rate, and pause time setting for each step. Setting can be saved under rogram.

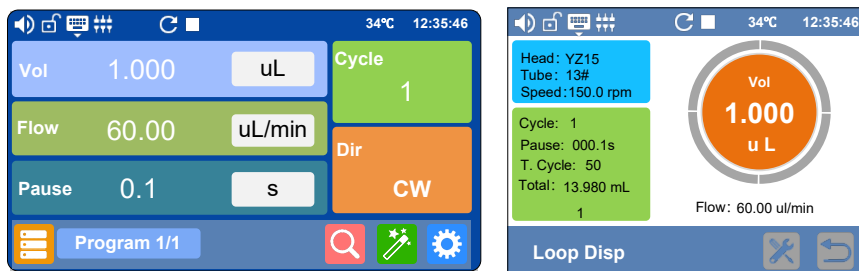

Figure 51 Loop Dispense Mode

A - Total dispense volume,  $\mu\text{L}$ , mL or L

B - Dispensing flow rate,  $\mu\text{L}/\text{min}$ , mL/min

C -Pause time. The time between doses, hours, minutes, and seconds.

D - Cycle. When the dispensing cycle is 1, the pump runs only once. When the dispensing cycle is more than 1, the pump will automatically enter the next step when the set number of cycles completed.

E - Direction: Clockwise or counterclockwise

The preview interface shows the current pump head, tubing size, cycle and pause time setting for the current step, the set cycles, volume transferred, and total cycles run.

The current setting will be saved to the “program 1” group. Press , to set total steps and total cycles. There are up to 30 available steps.

## 8.5 External Control Mode

The external input mode analog controls the speed and the external signal controls the start/stop and direction. The keypad is disabled.

- 1) Turn the power off. Wire the DB15 connector as shown below, and connect it to the DB15 port on the rear of the pump.

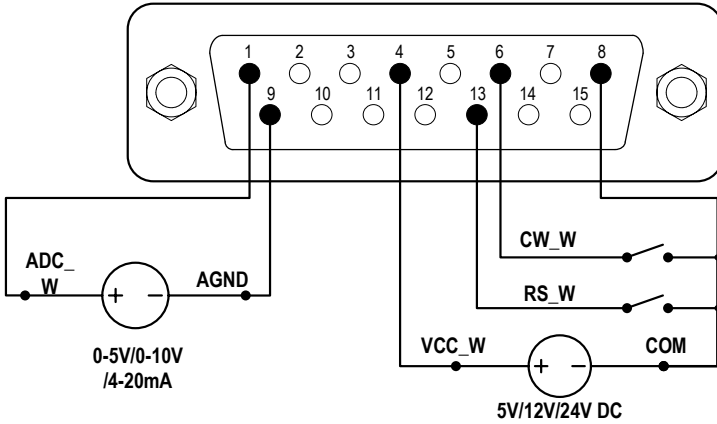

Figure 52 DB15 Wiring with an External DC Power Source

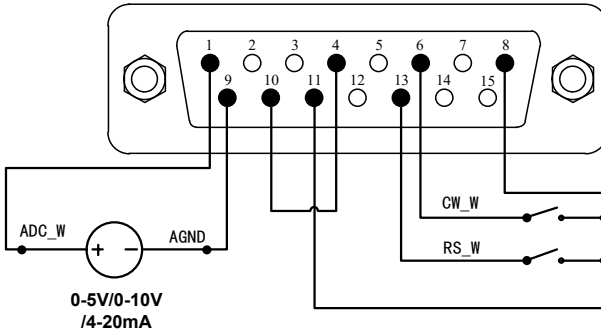
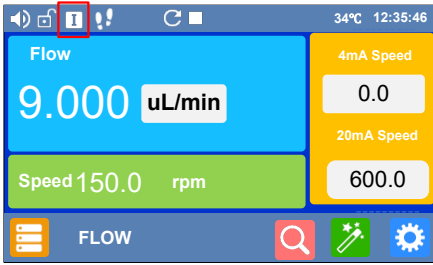
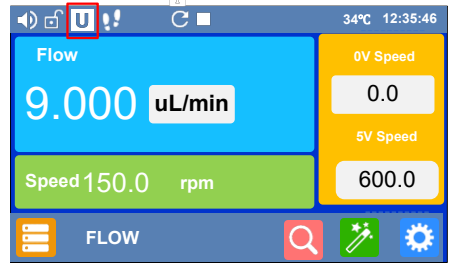

Figure 53 DB15 Wiring with the Internal 12V DC Power Source

- 2) Turn the power on. The pump will display the main screen.
- 3) Press the MODE key to select the flow mode
- 4) Select voltage mode or current mode by control mode



Current Control Mode



Voltage Control Mode

*Figure 54 Analog Control Interface*

- 5) When setting the External Control Mode to Logic Level and closing the external RS\_W switch, the pump will run and the speed will change according to the analog input signal. Open the RS\_W switch to stop the pump.

When the CW\_W switch is opened, the pump will run clockwise. When the CW\_W switch is closed, the pump will run counterclockwise.

- 6) When setting the External Control Mode to Pulse, close and then open the external RS\_W switch, the pump will run and the speed will change according to the analog input signal. Close and open the RS\_W switch again to stop the pump.

When close then open the external CW\_W switch, the pump will run clockwise. When close then open the CW\_W switch again, the pump will run counterclockwise.

**Note:** The external DC power source could be 5V, 12V or 24V.

## 8.6 Communication mode

The RS485 interface supports the standard MODBUS protocol. The pump can be controlled by an external device via the communication port. Please refer to the [Communication Instruction Manual](#) for the parameters and supported commands.

- 1) Turn the power off. Wire the DB15 connector as shown in Figure 55 or Figure 56, and connect it to the DB15 port on the rear of the pump.

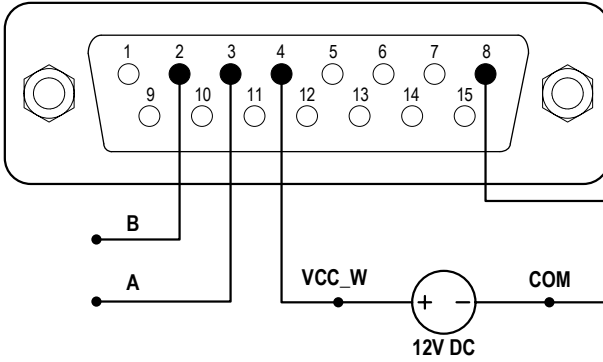

Figure 55 Control Start/Stop with an External 12V Power Source

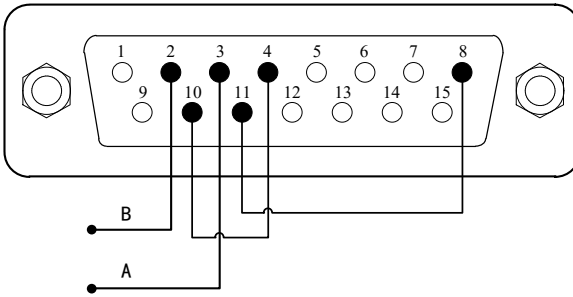

Figure 56 Control Start/Stop with the Internal 12V Power Source

2) Turn the power on. The pump will display the main screen.

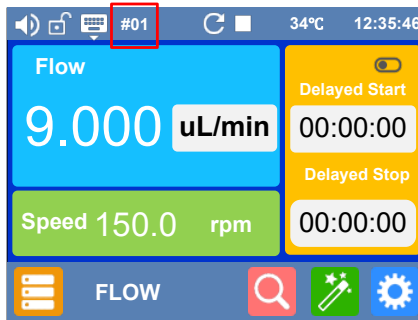

Figure 57 Communication Connected

3) When the main screen shows the Pump number (such as #01) in the Internal Control Mode, the communication is connected. Otherwise, the communication is disconnected.

- 4) The peristaltic pump communicates via RS485, with a default setting of 9600 communication rate, 8 data bits, an even parity check and a stop bit of 1. The parameters can be modified in the common parameters of the communication settings, as shown in Figure 58. When successfully connected, the functions of the pump can be controlled by the communication device.

Baud(bps)	X	Parity Bit	X
4800	<input type="radio"/>	NONE	<input type="radio"/>
9600	<input checked="" type="radio"/>	ODD	<input type="radio"/>
19200	<input type="radio"/>	ECC	<input checked="" type="radio"/>
38400	<input type="radio"/>		

Byte Order	X
CDAB	<input type="radio"/>
ABCD	<input type="radio"/>
	<input checked="" type="radio"/>

Figure 58 Communication Interface

## 8.7 Footswitch

Turn the power off. Wire the DB15 connector as shown in Figure 59 or Figure 60, and connect it to the DB15 port on the rear of the pump.

Turn the power on. The pump will display the main screen.



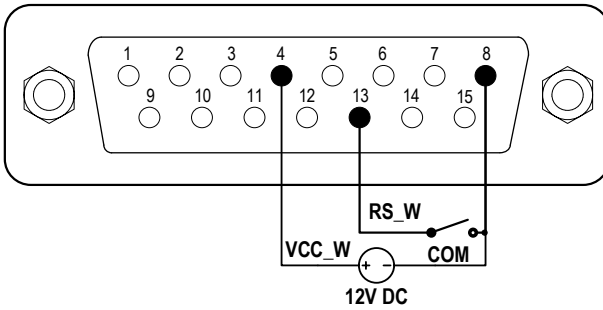

Figure 59 Footswitch Control Start/Stop with external 12V Power Source

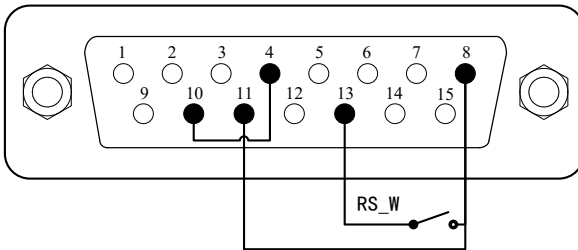

Figure 60 Footswitch Control Start/Stop with the internal 12V Power Source

If the pump is set to Volume, Time or loop Dispense Mode in the Internal Control Mode, the pump will start to dispense when the switch RS\_W is closed and then opened.

If the External Control is set to Logic Level in the Footswitch Control Mode, the pump will start when the switch RS\_W is closed and the pump will stop when the switch is opened.

If the External Control is set to Pulse in the Footswitch Control Mode, the pump will start when the switch RS\_W is closed and then opened and the pump will stop when the switch is closed and then opened again.

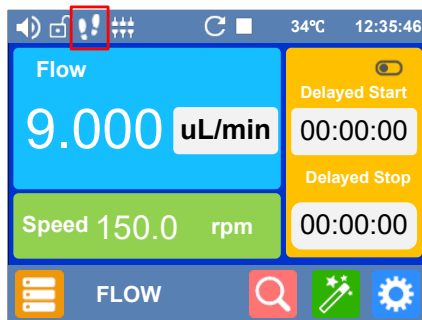

Figure 61 Footswitch Control

## 9 Maintenance

### 9.1 Warranty

The product comes with three-year warranty. The limited warranty does not cover any damage that is caused by improper usage and handling.

### 9.2 Regular Maintenance

- 1) To avoid leakage, always check the tubing and connections.
- 2) Do not cover the fan on the rear of the pump.
- 3) Do not use water to wash the pump. Keep the pump head dry.
- 4) Do not use chemical solvents to clean the pump and pump head.

### 9.3 Malfunction Solutions

No.	Malfunction	Description	Solution
1	Hardware	No display	<ol style="list-style-type: none"> <li>1. Check the power cord</li> <li>2. Check the fuse. If it was blown, replace it with a 1A slow-blow fuse</li> <li>3. Check the internal power cord connection inside the pump.</li> <li>4. Check the wire connection between the LCD and the main control board.</li> </ol>
2	Hardware	Motor does not work	<ol style="list-style-type: none"> <li>1. Check the indicator of the driver board.</li> </ol>

BT100F/BT300F/BT600F Peristaltic Pump

			<ol style="list-style-type: none"> <li>2. Check the wire connection between the motor and the driver board.</li> <li>3. Check the wire connection between the driver and the main board.</li> <li>4. Check the power voltage for the pump.</li> </ol>
3	Hardware	Motor is trembling	<ol style="list-style-type: none"> <li>1. Check the wire connection between the motor and the driver board.</li> <li>2. The motor is overloaded. Check the mechanical connection.</li> </ol>
4	Hardware	Motor only runs in one direction	Check the connection between the drive board and the main control board.
5	Hardware	Keypad does not work	<ol style="list-style-type: none"> <li>1. Check the wire connection between the keypad and the main board.</li> <li>2. Check if the key is broken.</li> </ol>
6	Hardware	External control does not work	<ol style="list-style-type: none"> <li>1. Check the wiring of the connector.</li> <li>2. Check if the external control power voltage is provided.</li> <li>3. Check the connections of the external control board.</li> </ol>
7	Hardware	RS485 com does not work	<ol style="list-style-type: none"> <li>1. Check the wiring of the connector.</li> <li>2. Check if the external control power voltage is provided.</li> <li>3. Check the connections of the communication board.</li> </ol>
8	Hardware	Noisy when running	Check the screws and level on the pump head to make sure they are secure.
9	Software	External control does not work	Check if the pump is in External Control Mode.
10	Software	RS485 does not work right	<ol style="list-style-type: none"> <li>1. Check if the display shows the communication is ready.</li> <li>2. Reset the address of the pump.</li> </ol>

3. Check whether on the bus there are two pumps using the same address



If a problem cannot be solved, please contact the manufacturer or distributor.

This product is not medically approved. When used as a component in a medical device, the medical device itself requires medical certification.

## 10 Dimensions

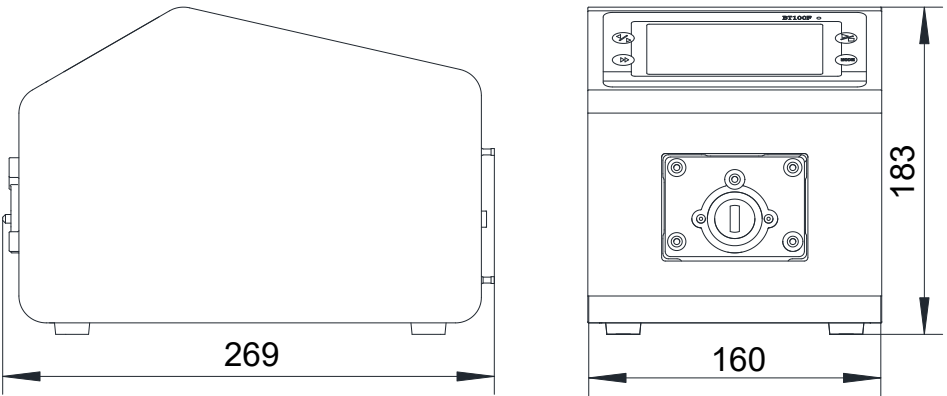
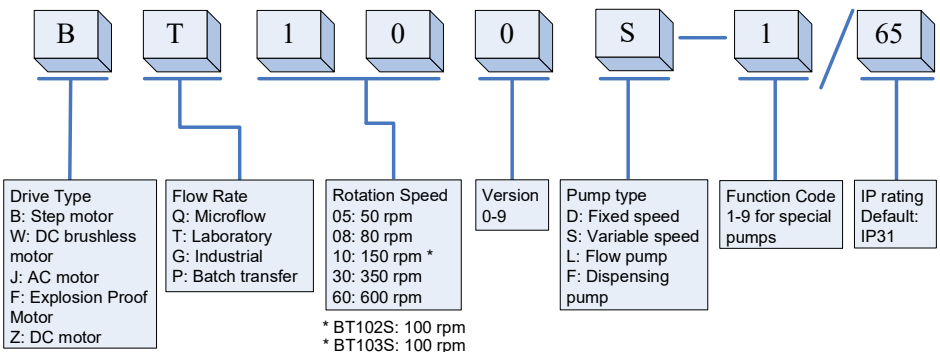

Figure 62 Dimensions (mm)

## 11 Naming Rule



## 12 Specifications

Speed resolution	0.1 rpm
Speed accuracy	0.2%
Power supply	AC 100-240V 50Hz/60Hz
Power consumption	BT100F: < 40W; BT300F:< 50W; BT600F: < 60W
Logic level control signal	5V, 12V, 24V
External analog control signal	0-5V (standard); 0-10V, 4-20mA (optional)
Communication interface	RS485 MODBUS
Operating condition	Temperature 0~40°C, Relative humidity <80%
IP grade	IP31
Display	TFT Touch Screen LCD, 65536 Colors
Dimensions (LxWxH)	269X160X183mm
Weight	5.5Kg

### BT100F Suitable Pump Heads and Tubing, Flow Parameters

Pump head	No. of Channels	Tubing size (mm)	Flow rate per channel (mL/min)
DG6-1 (6rollers)	1	Wall:0.8~1, ID:≤2.4	0.00016~26
DG10-1(10rollers)	1	Wall:0.8~1, ID:≤2.4	0.00011~20
DG6-2 (6rollers)	2	Wall:0.8~1, ID:≤2.4	0.00016~26
DG10-2 (10rollers)	2	Wall:0.8~1, ID:≤2.4	0.00011~20
DG6-4 (6rollers)	4	Wall:0.8~1, ID:≤2.4	0.00016~26
DG10-4	4	Wall:0.8~1, ID:≤2.4	0.00011~20
DT10-18	1	13# 14#, Wall:0.8~1, ID:≤3.17	0.0002~82
DT10-28	2	13# 14#, Wall:0.8~1, ID:≤3.17	0.0002~82

**BT100F/BT300F/BT600F Peristaltic Pump**

YZ15	1	13# 14# 16# 19# 25# 17#	0.0006~420
YZ25	1	15# 24#	0.16~420
YT15	1	13# 14# 16# 19# 25# 17# 18#	0.006~570
YT25	1	15# 24# 35# 36#	0.17~720

**BT300F Suitable Pump Heads and Tubing, Flow Parameters**

<b>Pump head</b>	<b>No. of Channels</b>	<b>Tubing size</b>	<b>Flow rate per channel (mL/min)</b>
YZ15	1	13# 14# 16# 19# 25# 17#	0.006~990
YZ25	1	15# 24#	0.16~990
YT15	1	13# 14# 16# 19# 25# 17# 18#	0.006~1300
YT25	1	15# 24# 35# 36#	0.16~1600

**BT600F Suitable Pump Heads and Tubing, Flow Parameters**

<b>Pump head</b>	<b>No. of Channels</b>	<b>Tubing size</b>	<b>Flow rate per channel (mL/min)</b>
YZ15	1	13# 14# 16# 19# 25# 17# 18#	0.006~1700
YZ25	1	15# 24#	0.16~1700
YT15	1	13# 14# 16# 19# 25# 17# 18#	0.006~2300
YT25	1	15# 24# 35# 36#	0.16~2900



**Golander LLC**

4405 International Blvd  
Ste B117, Norcross, GA 30093  
USA  
Tel: +1 678-587-8806  
info@golanderpump.com  
www.golanderpump.com

**Golander GmbH**

Dechant-Heimbach-Str. 29  
53177 Bonn  
Germany  
Tel: +49 228 50446952  
info@golander.de  
www.golander.de