



Aeon AcousticPro UHD Series

EDGE FREE® Fixed Frame Sound Transparent Projection Screen









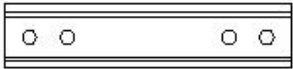
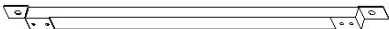

User's Guide

Product Description: The Aeon *AcousticPro UHD* Series is a fixed frame projection screen that uses Elite's EDGE FREE® technology. The EDGE FREE® design resembles a giant size flat panel TV display. The Aeon includes **Edge trim** as an installation option to further enhance the frame appearance and absorb projector overshoot. An optional LED backlighting kit is available for added visual appearance.

For more information on the LED kit please visit: <http://www.elitescreens.com/led>

Hardware and Parts List

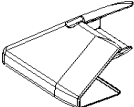
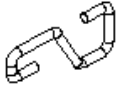
Please make sure all parts listed below are included before installation.

<p>A. Elbow joint x 4 pcs</p> 	<p>B. Top/Bottom horizontal fame x 4 pcs</p> 	<p>C. Left/Right vertical frame x 2 pcs</p> 
<p>D. Center joints x 2 pcs</p> 	<p>E. Center Support bar x 1-2 pcs</p> 	<p>F. Wall brackets x2-3 pcs</p> 
<p>G. M5x50 screws and anchor x 6 pcs</p> 	<p>H. M5x15 screw x 24 pcs</p> 	<p>I. Black Tape x 1 bag</p> 
<p>J. Edge trim x6 pcs</p> 	<p>K. Plastic corner sleeve x 4 pcs</p> 	<p>L. Hook</p> 
<p>M. Fiberglass rod x 6 pcs & Plastic sleeve x 12 pcs</p> 		

Frame Assembly

1. Insert the center joint into one of the $\frac{1}{2}$ *horizontal frames (B)* and fasten it with the two *M5x15 screws (H)*.
2. Insert the other $\frac{1}{2}$ horizontal frame piece to the center joint and fasten also using two *M5x15 screws*.
3. Repeat steps 1 and 2 for assembling the second horizontal frame.

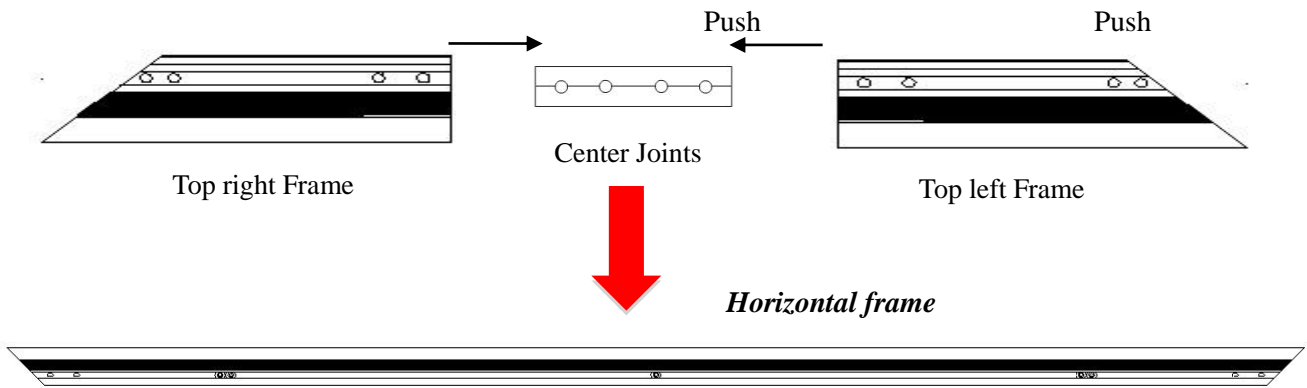

4. Insert the *elbow joint (A)* into each end of the *horizontal frames (B)* as shown below.

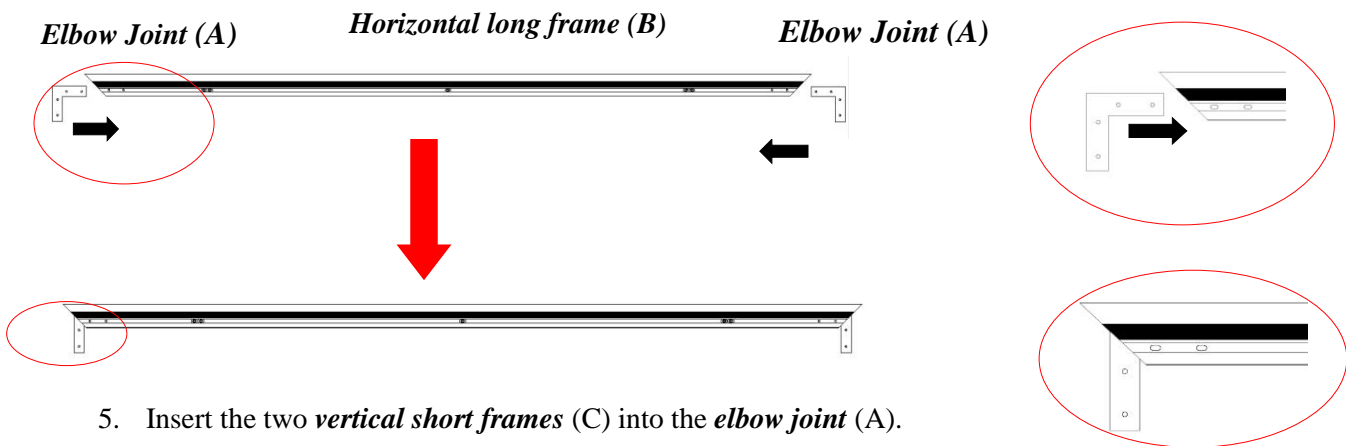

5. Insert the two *vertical short frames (C)* into the *elbow joint (A)*.

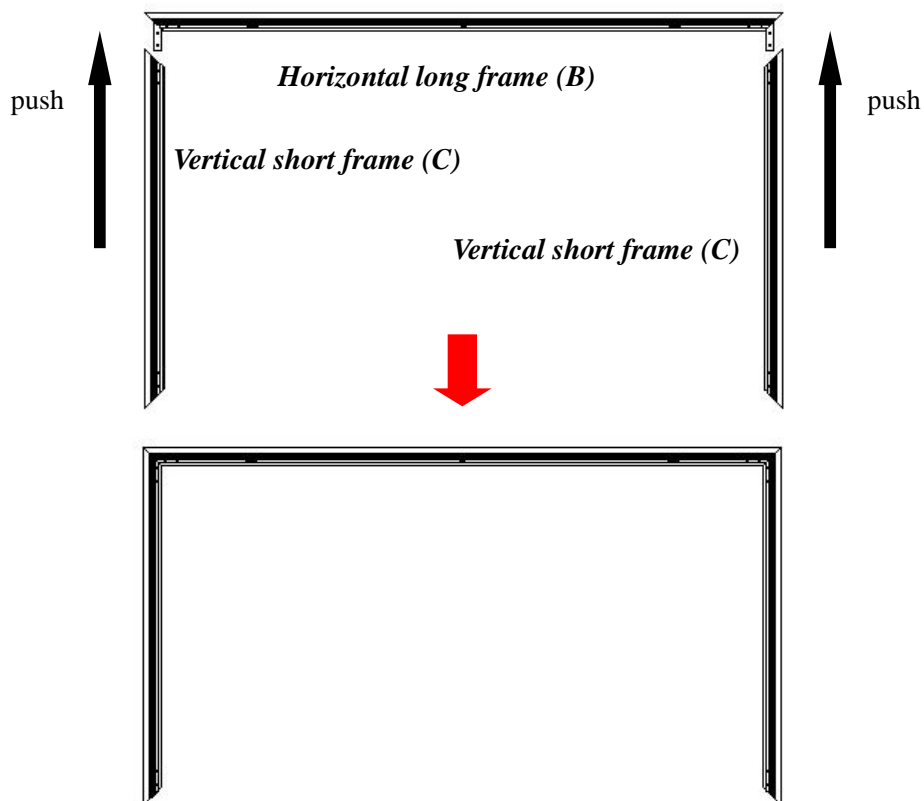

6. Join the remaining *horizontal long frame (B)* with the frame built in the previous steps as shown below.

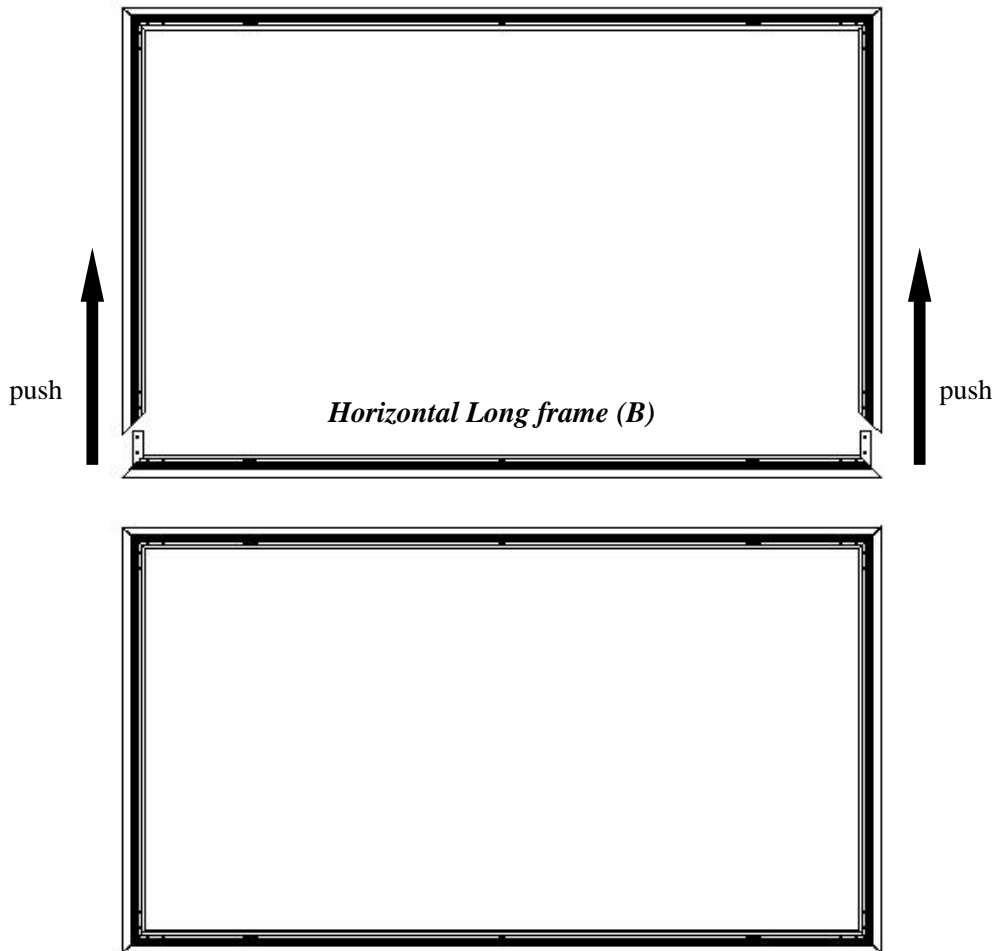

7. Make sure all four corners are properly in place to form a perfect square. Then fasten the four angles with the *M5x15 Screws (H)*.

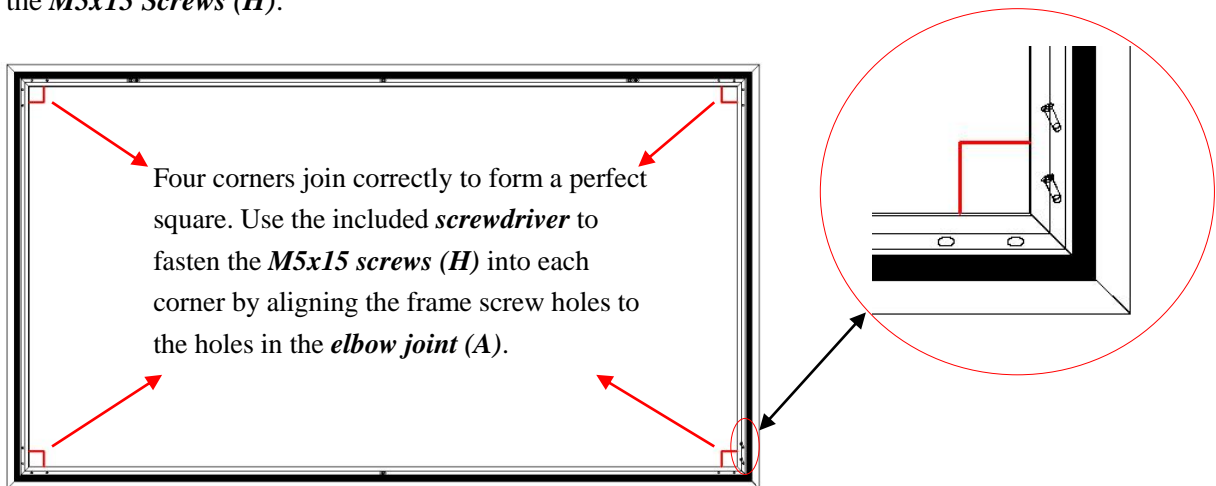

Screen Material Installation

1. Lay the *screen material* completely flat with the front facing down on a clean surface in a horizontal position. The back side of the screen material should be placed upwards.

Note: The back side of the material has the velcro borders all around the edges.

2. Carefully and gently place the assembled frame on top of the screen material as shown below. Make sure to not allow the angle edge of the frame to come in direct contact with the screen material to avoid puncturing it.

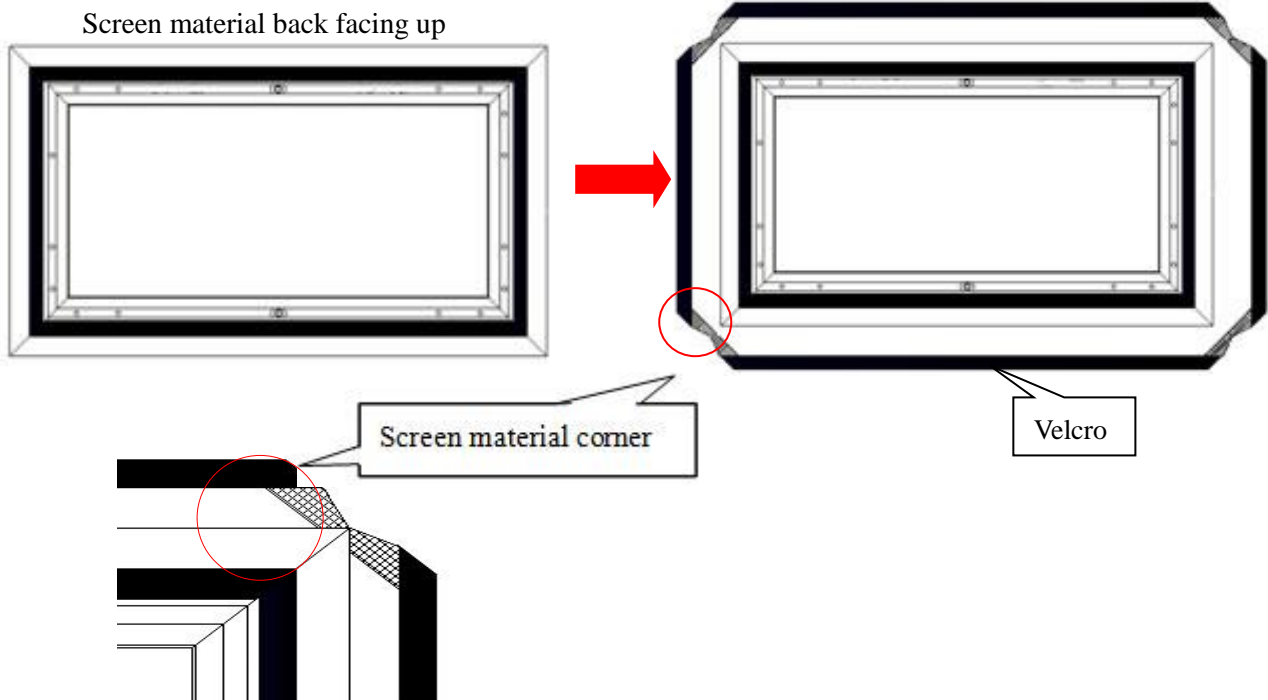

3. After all of the corners of the frame have been properly aligned, attach the material to the frame in the following order A→B→C→D (see instructions below for details).

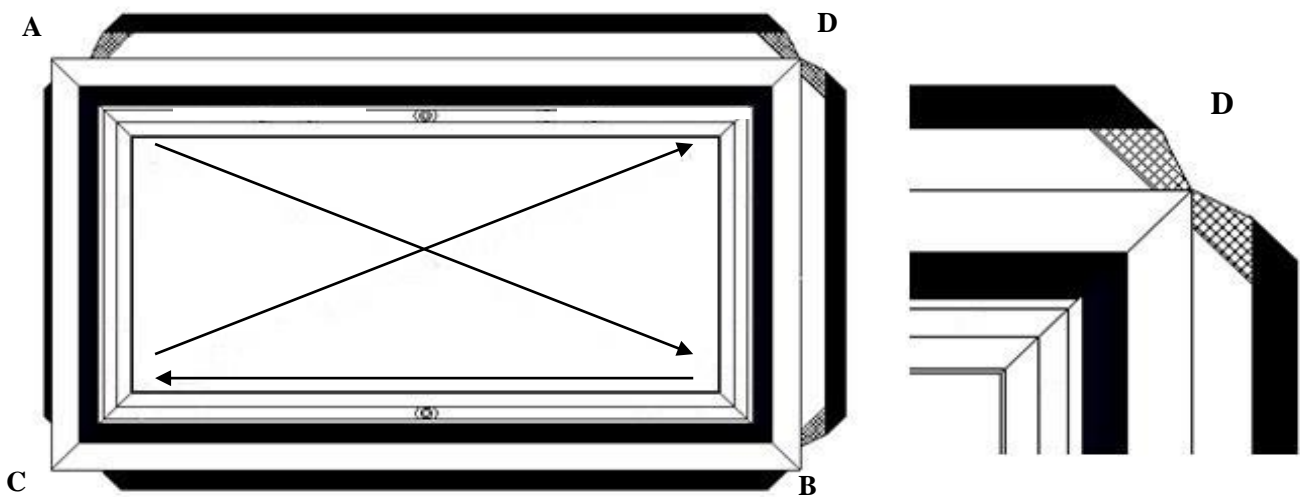

Attach the screen material to the corners as shown below.

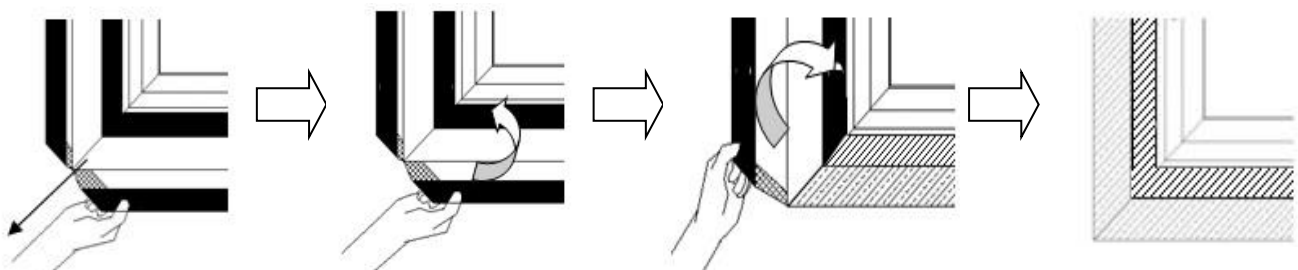

1) Stretch the screen material in the direction of the arrowhead.

2) Fold over and attach material to the velcro strip of the frame.

3) Fold over second side and attach to frame

4) Repeat until all four sides are done in the order A, B, C, D

4. After all four corners have been attached; please check whether the frame corners are wrapped by the screen material. If not, please loosen the velcro connection and repeat the above steps so the frame is not exposed.

Note:
Represents the
screen material

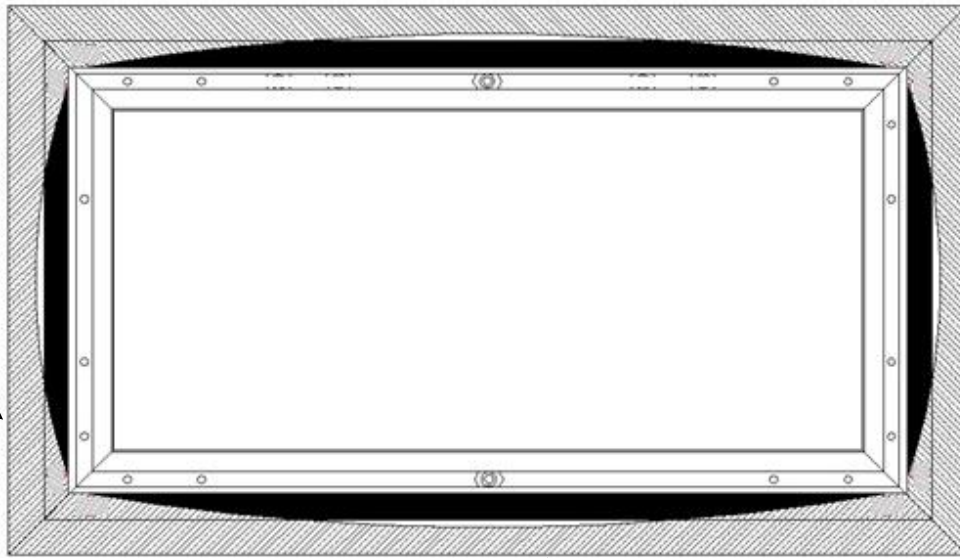

Note: The black shaded part represents the velcro on the frame. That Velcro end will ultimately attach with the other velcro end on the screen material.

5. Proceed to attach the rest of the material to the frame as described in the illustrations below.

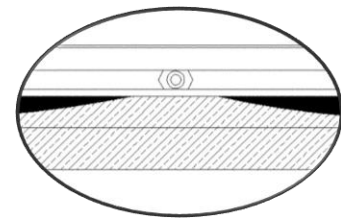
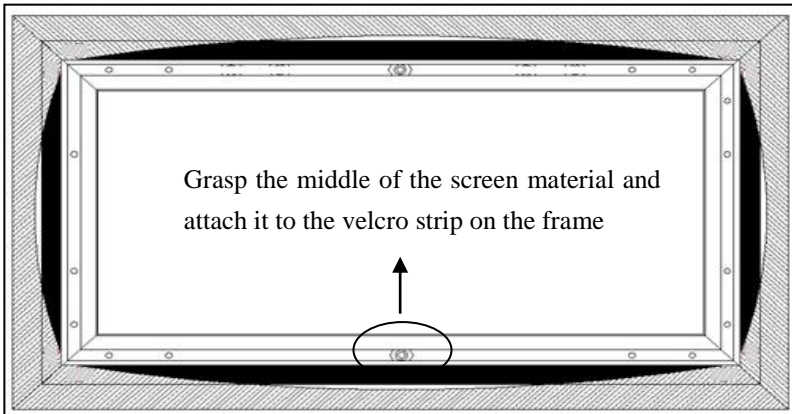

Lay the Velcro end on the screen material over the Velcro end of the frame and keep it within the edge.

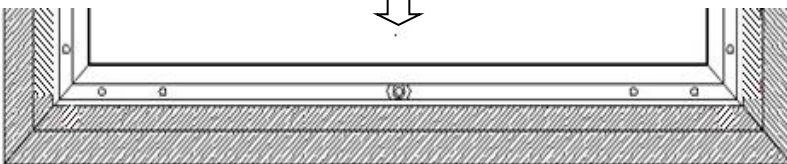
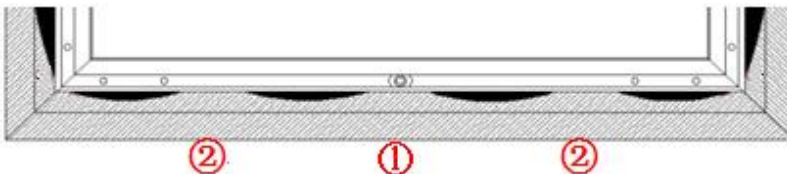
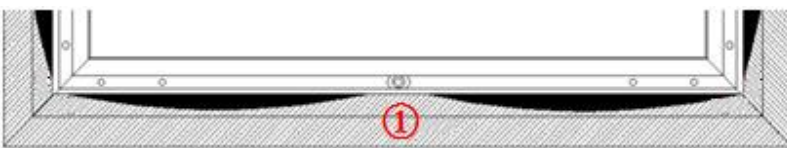

Proceed in the following sequence below ①→②

The key is to attach within the middle sections of 1 and 2. Then continue attaching the remaining unattached areas.

Repeat the same steps on the remaining three sides in the sequence A, B, C, and D as shown below.

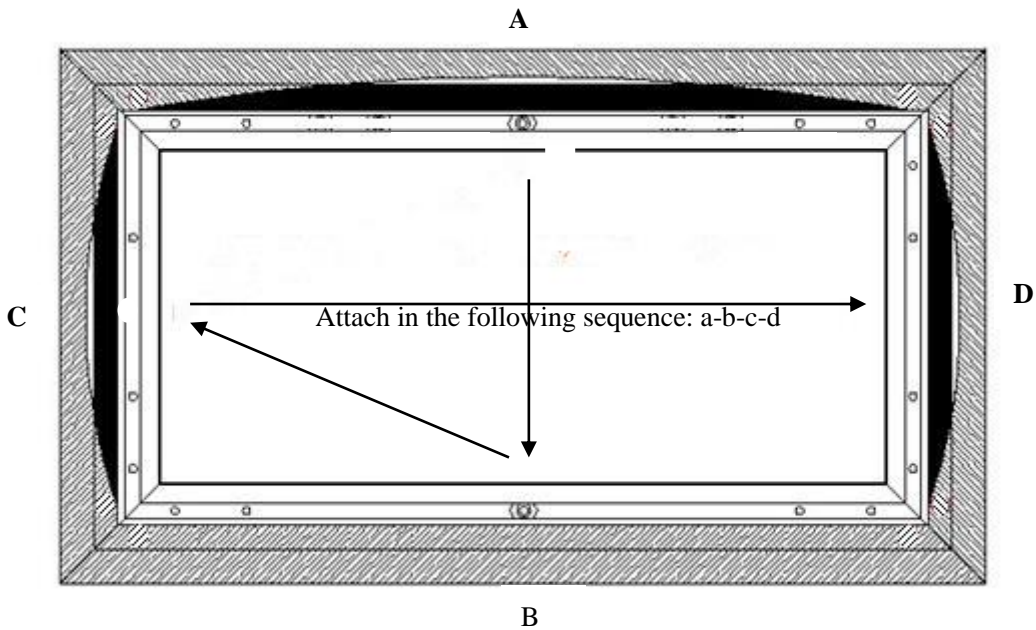

Screen Material Removal

Follow the steps to properly remove the screen material from the frame. This procedure will ensure prolonging the life of the screen material.

1. Detach the velcro from the frame.
2. Gently pull back the material to release the material from the velcro connections on the corners.

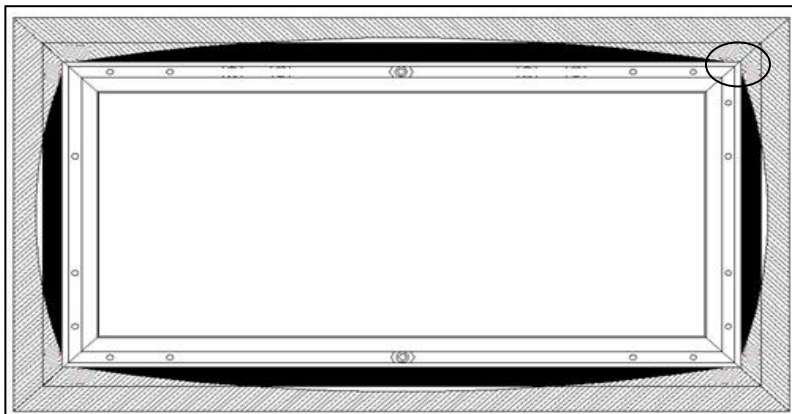

Pull back the screen material from the velcro connection along the edges of the frame to detach it.

Support bar installation (for models under 135")

1. Position the *center support bar (E)* in the middle of the frame and align the hole on each end of the support bar with the *M6 hex screws* on the top and bottom frames. Then fasten with the *M6x12 screws*.

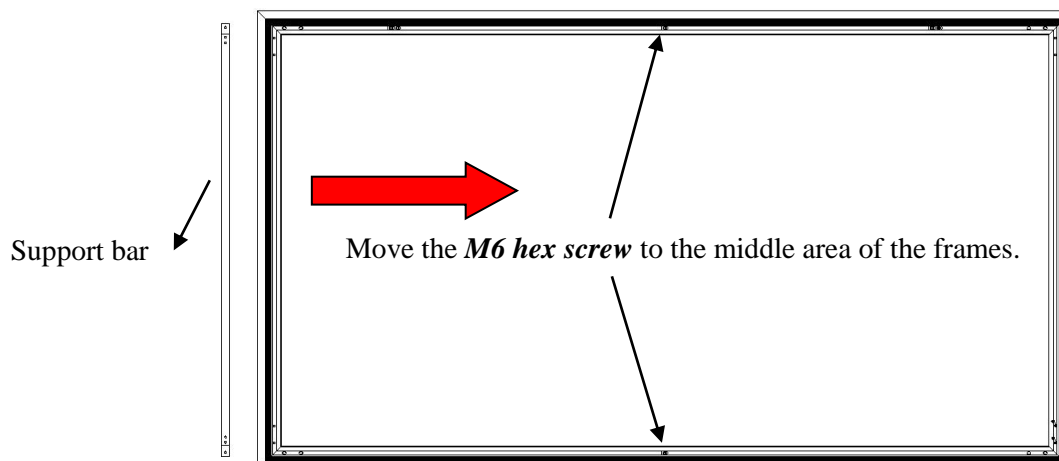

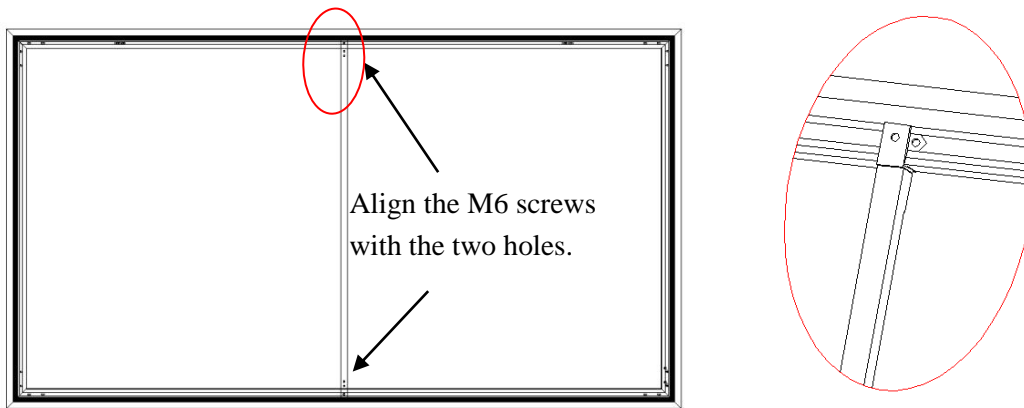

Support bar installation (for models 135" and above)

1. Position the *center support bar (E)* to the area of the frame shown in figure 1. Align the hole on each end of the support bar with the *M6 hex screws* on the top and bottom frames. Then fasten with the *M6x12 screws*.

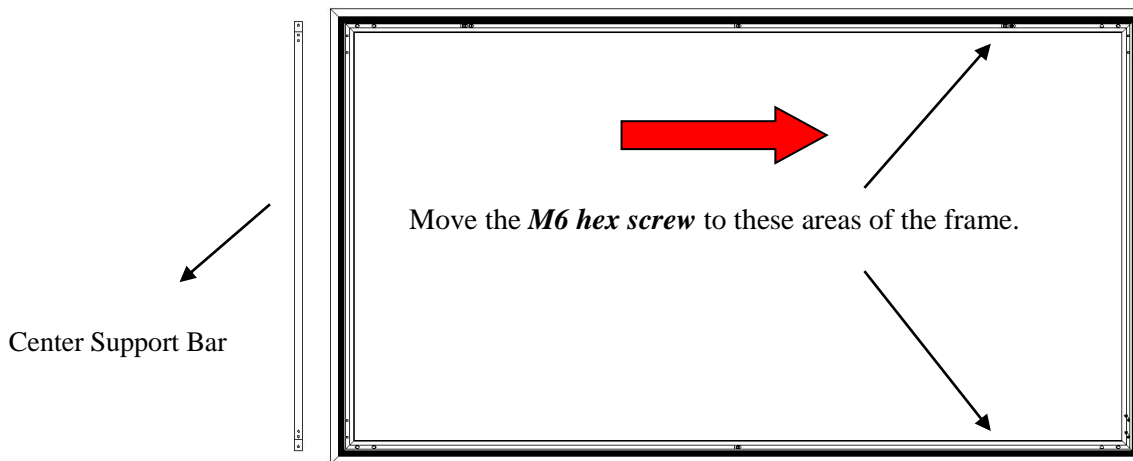
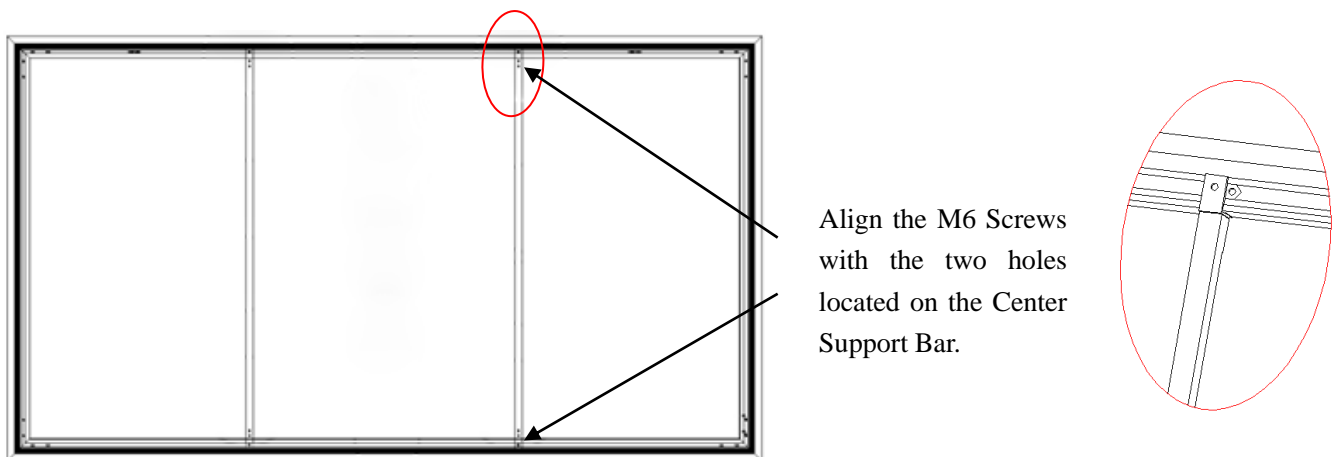
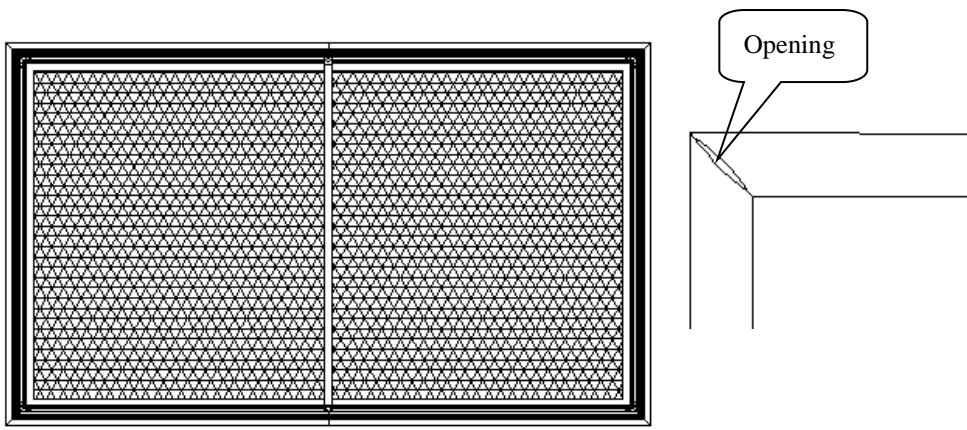

Figure 1



Black Backing Installation

1. Lay the Black backing completely flat with the opening side facing down on the white (AcousticPro UHD) material in a horizontal position under the center support bar.



2. Put the plastic sleeves on the fiberglass rods.

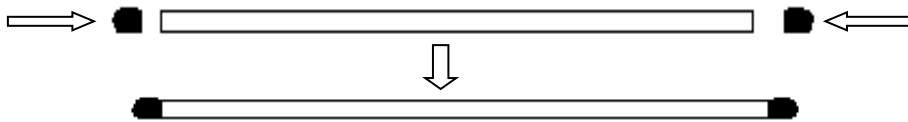

3. Insert *the fiberglass rods (M)* through the openings. The longer rods are used on the vertical edges of the screen material, and the shorter rods are used on the horizontal edges, as shown below.

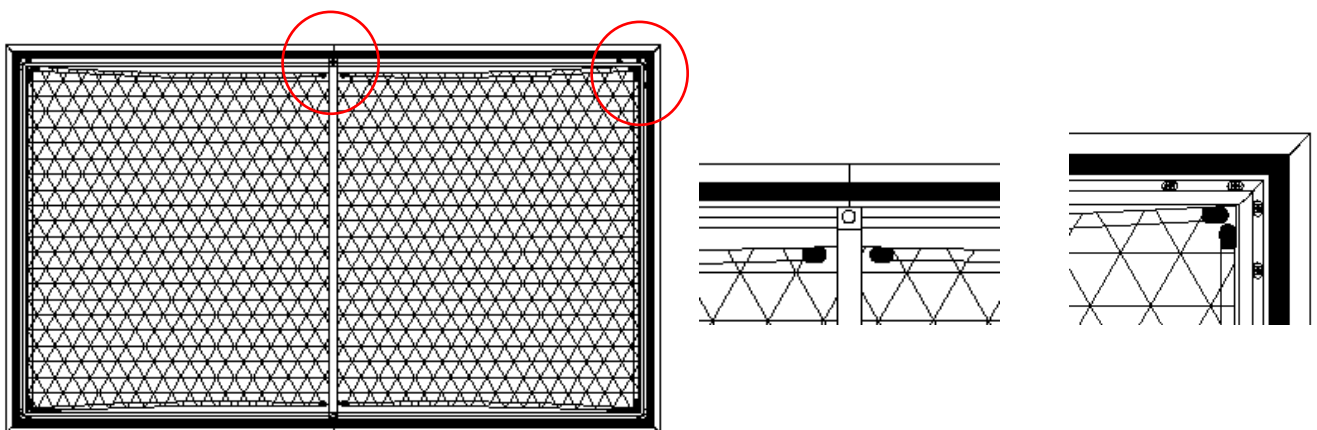
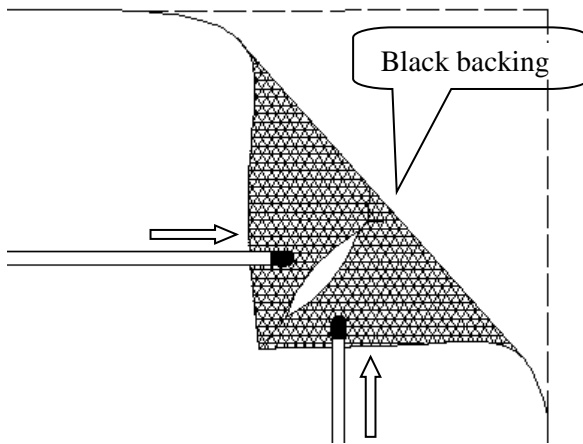

4. Hook installation

- 1) Follow steps 1, 2, 3 on Fig. 1 to properly affix the hook to the frame as shown in Fig. 2.
- 2) Affix the hooks on the red arrow marks (Fig. 3).

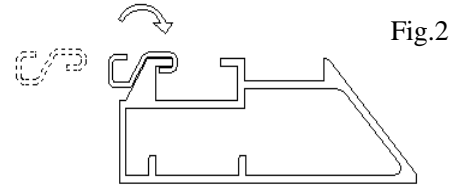
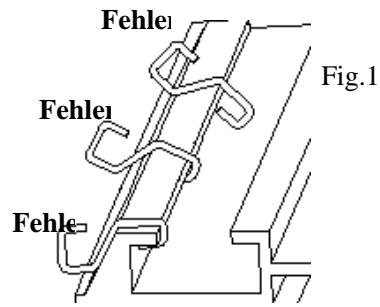
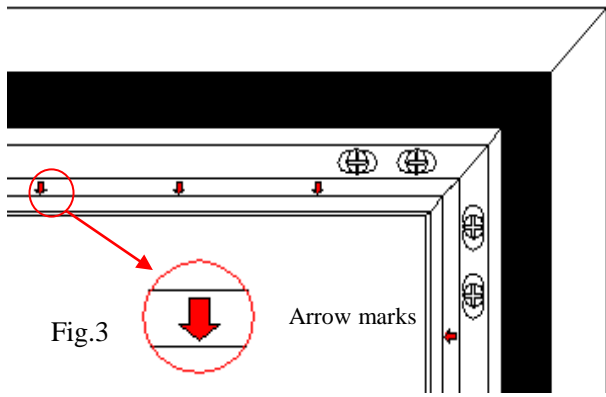

Example of properly affixed hook to frame.

NOTE: Make sure the hooks are affixed correctly as they are not easy to remove from the black mesh backing once they have been affixed.

5. Black backing material attachment into the hooks.

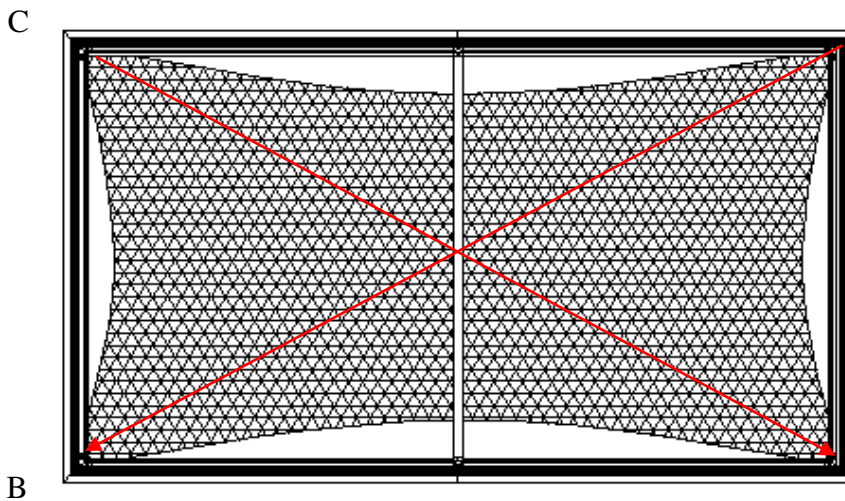
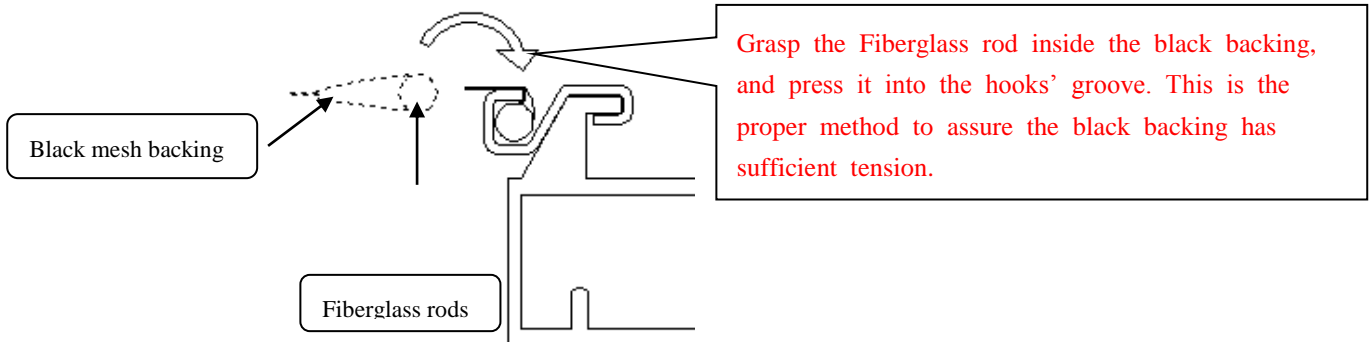

A

First, stretch the four corners of the black backing and insert into the first two hooks on each corner in the following sequence A → B → C → D.



D

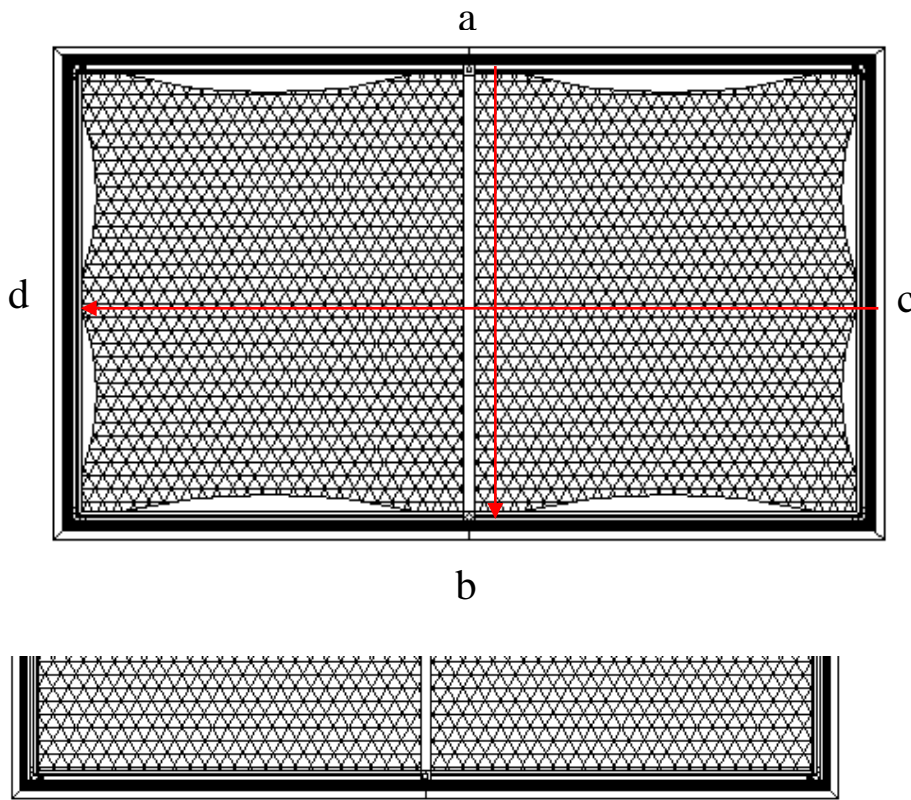

Next, stretch the black backing and affix to the hooks from the middle in the following sequence a→b→c→d

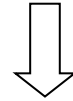

Lastly, affix the black backing to the remaining hooks. Add more hooks as needed to achieve flatter results in the areas that are not flat.

Edge trim Installation

The Aeon fixed screen is EDGE FREE®, but you may install the Edge trim to provide it with an elegant thin bezel finish.

Edge trim x 6 pcs



Plastic corner sleeve x4pcs

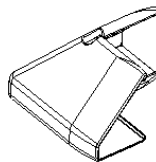

Black tape x1bag



1. Place the assembled frame on a flat and clean surface. The projection screen surface should be facing up.
 - a. As an option, Black Tape is supplied to cover any possible gaps between the pieces of the bezel trim. Align the tape with the edge of the screen, as shown in Figure 1. Once properly aligned, apply the black tape to the center of the top and bottom of the screen material.

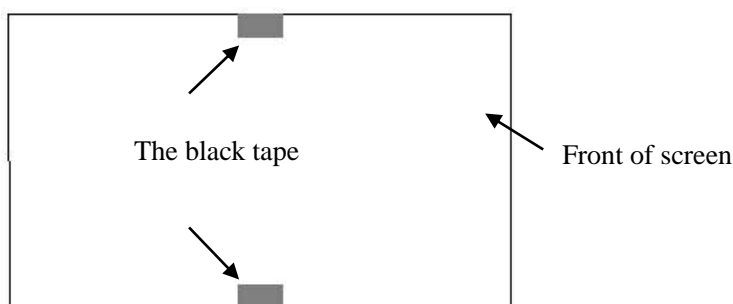
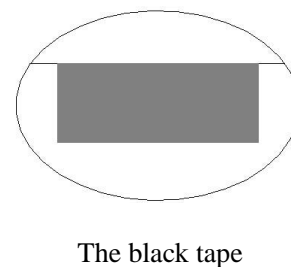
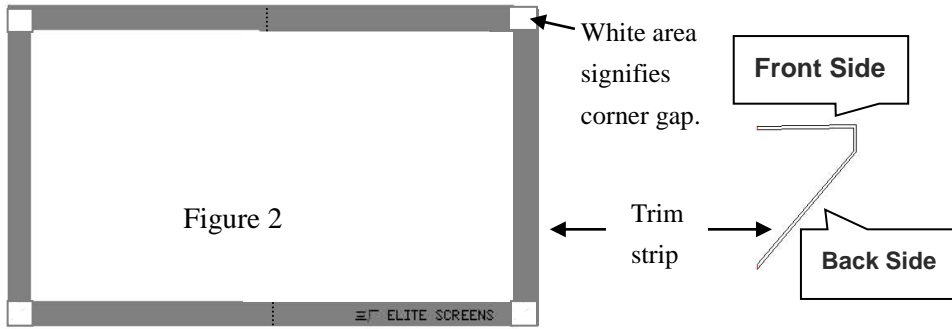

Figure 1



The black tape

2. Without removing the adhesive tape, place all the trim pieces along the edge of screen material. Adjust the trim so that the top and bottom trim pieces are touching and show no gaps in the center. (Note: The Elite logo should be positioned on the bottom right). Refer to Figure 2 below for a visual reference.



TIP:
Align the trim starting from the center to reduce gapping. Any gaps left at the corners will be covered by the corner sleeves.

NOTE: Make sure the bottom edge trim with the Elite Screens logo is installed on the correct side. The back of the material should be labeled with a DOWN sticker to indicate the material is facing in the down position. The Elite Screens logo should be installed on the DOWN side

3. After properly aligning all trim pieces, carefully remove trim piece A (see Figure 3 below). Remove the inside backing of the tape and place the trim piece in its original position on the frame. Repeat this step for the remaining trim pieces in the following order: B-C-D-E-F.

The **front side** of the frame with trim pieces attached.

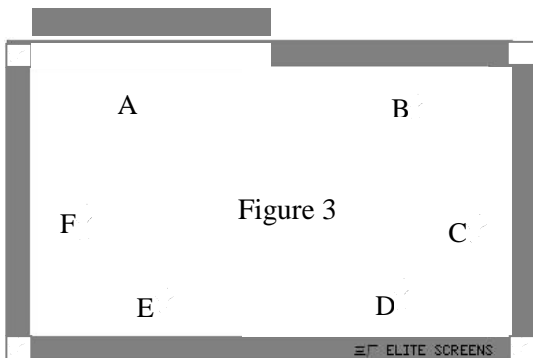

4. After the bezel trim has been installed, place a **corner sleeve (K)** on all four corners. Begin by aligning and adjusting the corner sleeve through the front of the screen. Make sure the corner sleeve completely wraps the edge of the bezel trim. This should cover any corner gaps.

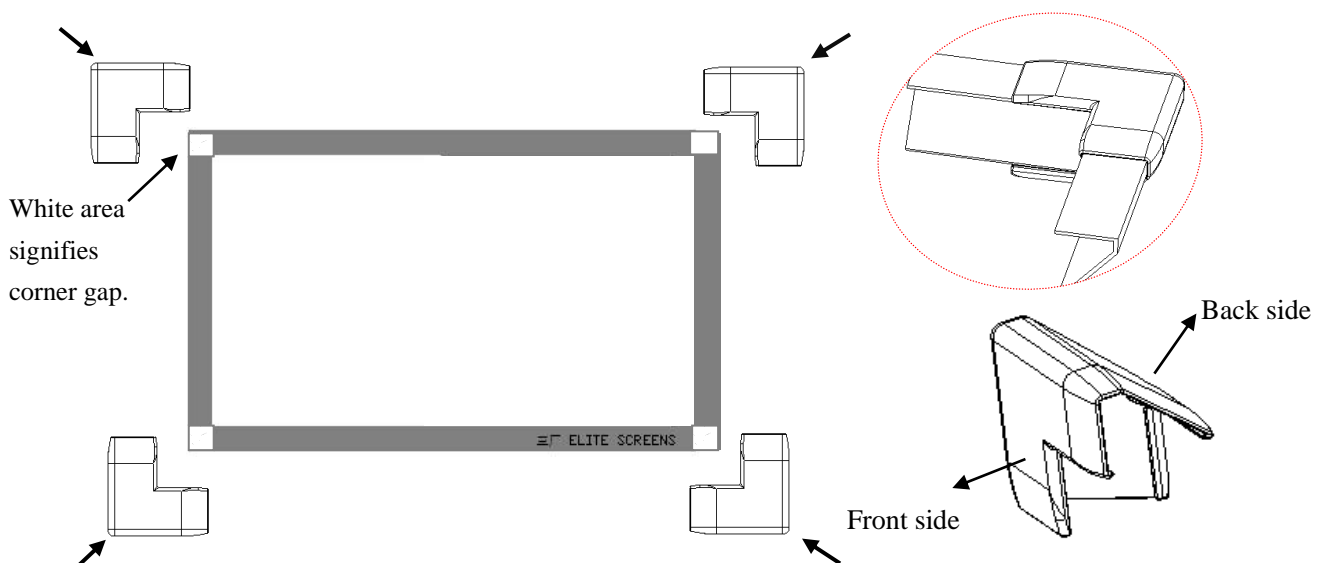

Once all corner sleeves have been snapped into each corner of the frame, it is ready to be installed.

Attention: Installing the edge trim will reduce the viewing size of your screen. See below illustrations for a comparison of the viewing size of the before and after edge trim installation using the 100" & 120" 16:9 diagonal models.

100" comparison:

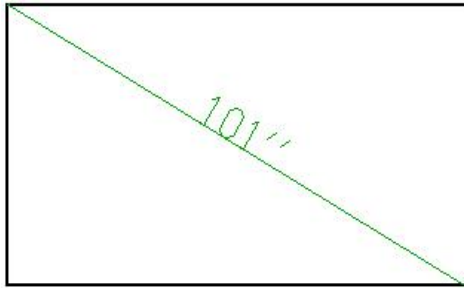

Before installing the edge trim

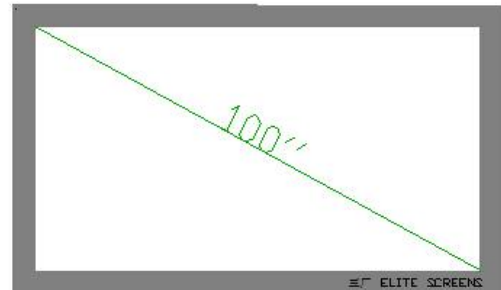

After installing the edge trim

120" comparison:

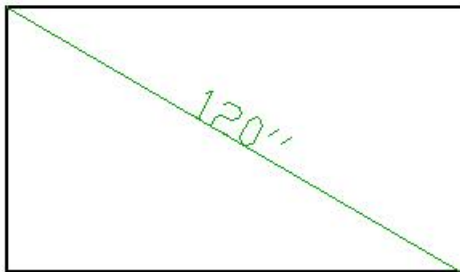

Before installing the edge trim

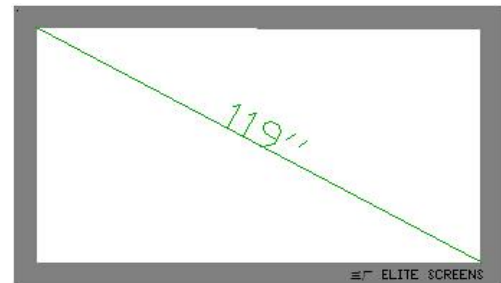

After installing the edge trim

Installation

Locate your desired installation location with a stud finder (recommended) and mark the drill-hole area of where the screen is to be installed.

1. Drill a hole with the proper bit size according to the wood screws included.
2. Line up the wall brackets with the drilled holes on the installation location and screw them in using a Phillips screwdriver.
3. Position the frame screen onto the *wall brackets (F)* as shown in **below**.
4. The design of the wall brackets allows the frame to slide over them through its sides. This is an important feature of the installation design as it allows your screen to be properly centered.

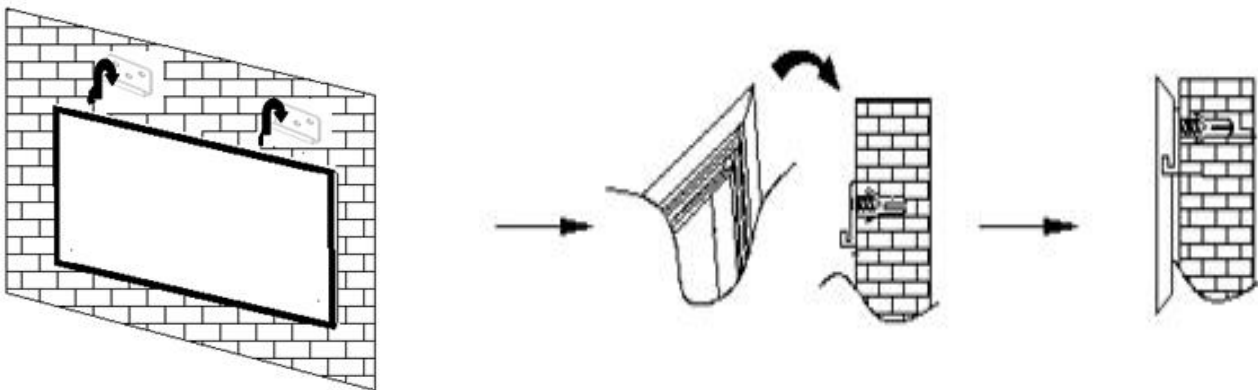

For a local Elite Screens contact or Technical Support, please visit

www.elitescreens.com



Aeon CineGrey 4D AT Series

*Ceiling Ambient Light Rejecting Acoustically
Transparent EDGE FREE® Fixed Frame Screen*

USER'S GUIDE E Type - V1

Product Description: The **Aeon Series** is a fixed frame projection screen that uses Elite's EDGE FREE® technology. The EDGE FREE® design resembles a giant size flat panel TV display. The **Aeon** includes a bezel trim to further enhance the frame appearance and absorb projector overshoot. An optional LED kit is available for back-lighting.

Congratulations on your new **Aeon CineGrey 4D AT** purchase! The ISF Certified **CineGrey 4D AT** is an ambient and ceiling light rejecting (ALR/CLR®) front projection screen material that is perforated for acoustic transparency. It is precisely formulated for environments with minimal control over room lighting. It was designed to enhance picture brightness, offer accurate color fidelity, improve contrast and allow sound to pass through.

In order for the CineGrey 4D AT material to maintain its projection qualities and provide optimum performance please refer to the list below for proper maintenance and cleaning.

The following precautions should always be followed to avoid damaging the material, which is not covered under warranty.

- Use a dry microfiber cloth or a soft bristle brush to remove dust from the screen's surface.
- When cleaning, use a damp microfiber cloth with warm water to remove any marks.
- Never rub or apply pressure when cleaning the surface.
- Never attempt to use any chemicals such as acetone, benzene, alcohol, organic solvents or abrasive cleaners

ther sharp or

Exploded View of Aeon Frame

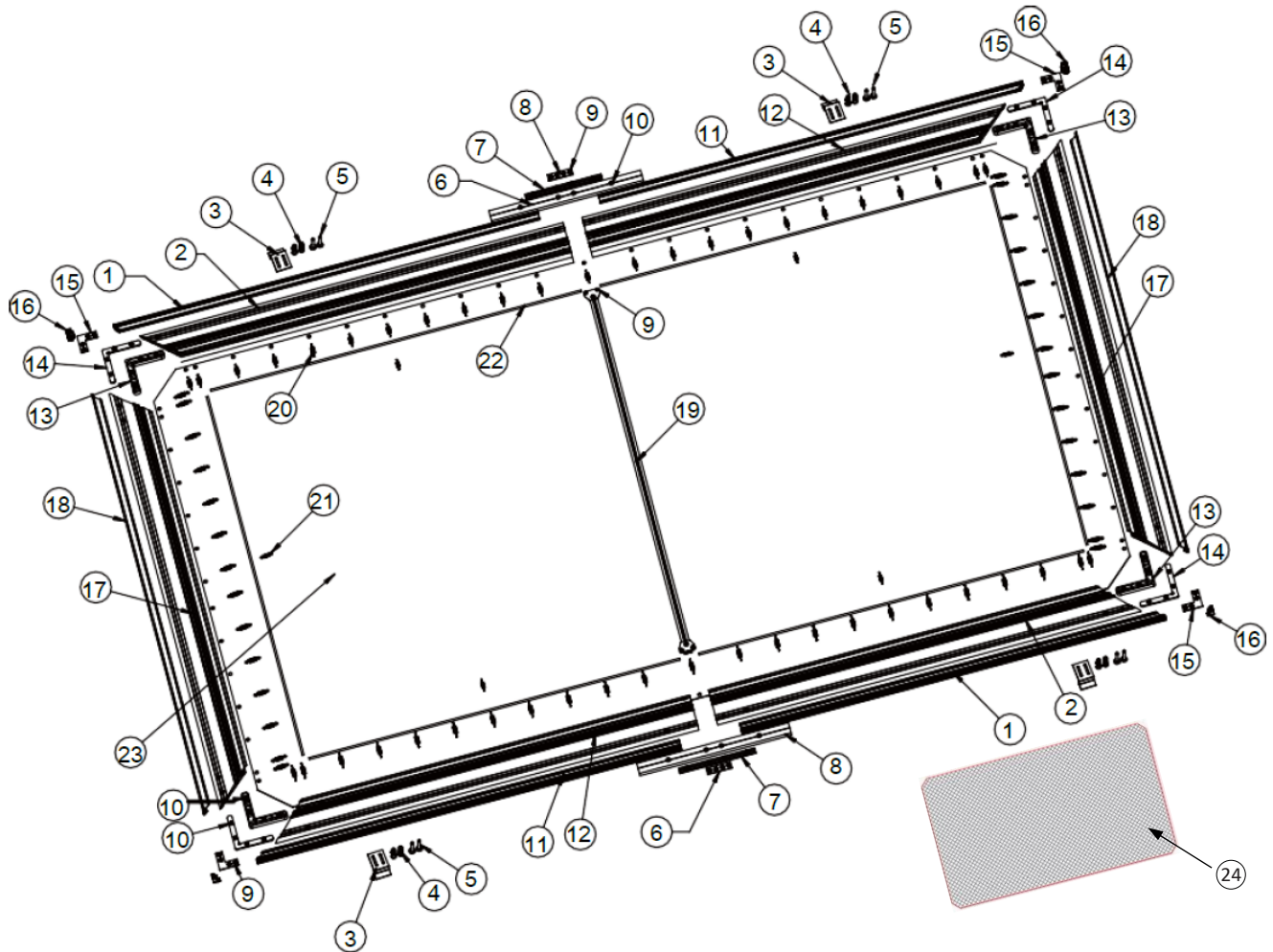

Make sure all parts are included before commencing frame assembly.

Hardware and Parts List

① Edge Trim A	⑦ Long Center Joints b	⑬ Elbow Joints a	⑲ Support bar
② Frame A	⑧ Short Center Joints	⑭ Elbow Joints b	⑳ Spring a
③ Wall Bracket	⑨ M4x4 Screws	⑮ Elbow Joints C	㉑ Spring b
④ Anchor	⑩ M5x6 Screws	⑯ Corner Cover	㉒ Fiberglass rod
⑤ Wood Screws	⑪ Edge Trim B	⑰ Frame C	㉓ Screen material
⑥ Long Center Joints a	⑫ Frame B	⑱ Edge Trim C	㉔ Black backing cloth

SCREEN INSTALLATION

1. Frame Assembly

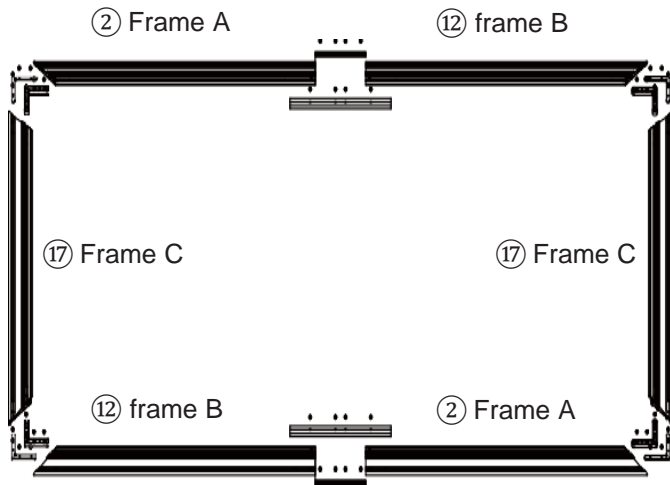

Step 1: Insert the long center joints (a) into each half horizontal frame (A/B) and secure with the screws. These will be the top/bottom frames.

Step 2: Insert the elbow joints into frame (C) and insert the other end of the elbow joints to the top/bottom frames and secure with the screws.

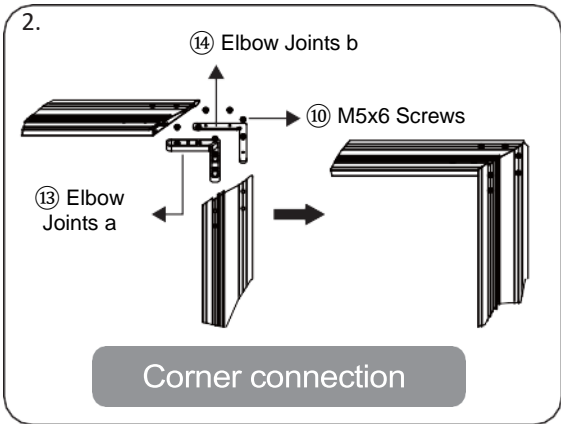
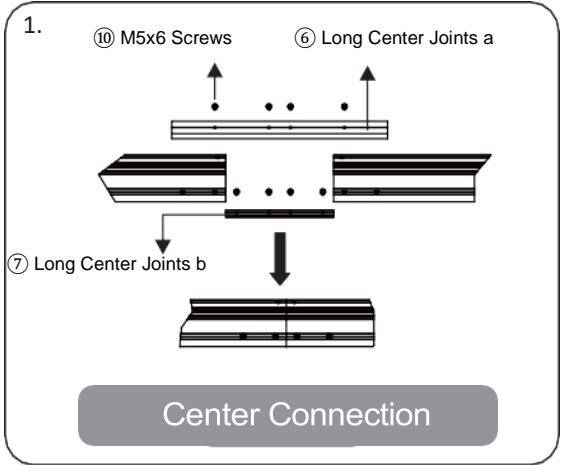

2. Center Support Bar Installation

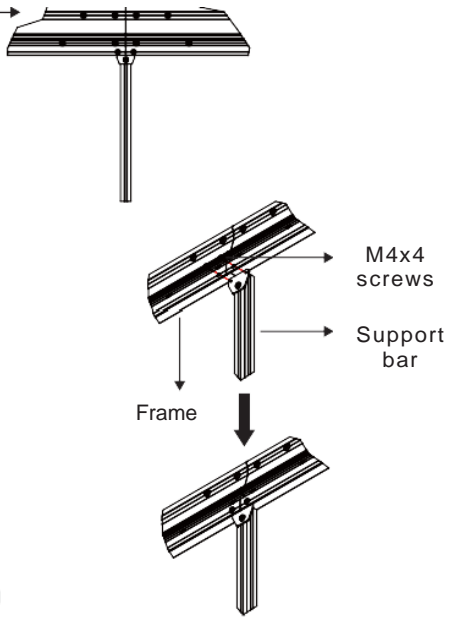
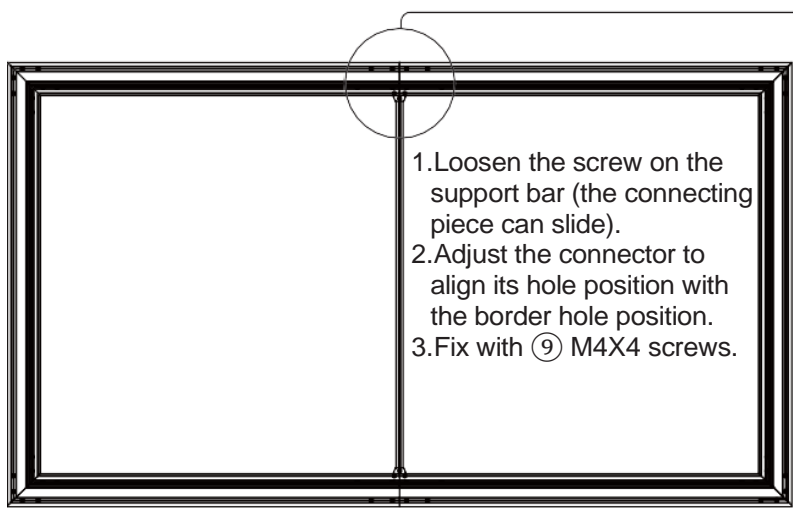

Note: the support bar is mounted in the upper and lower border splicing direction as shown on the right

3. Black Backing Cloth Installation

Dimension table of black backing cloth

Screen size	Fabric height	Fabric width
110"	1345 mm	2410 mm
125"	1532 mm	2742 mm
135"	1656 mm	2964 mm
150"	1843 mm	3296 mm

1. Put the black backing cloth on the sheet, then put the frame on the black backing cloth. (Velcro part face up)

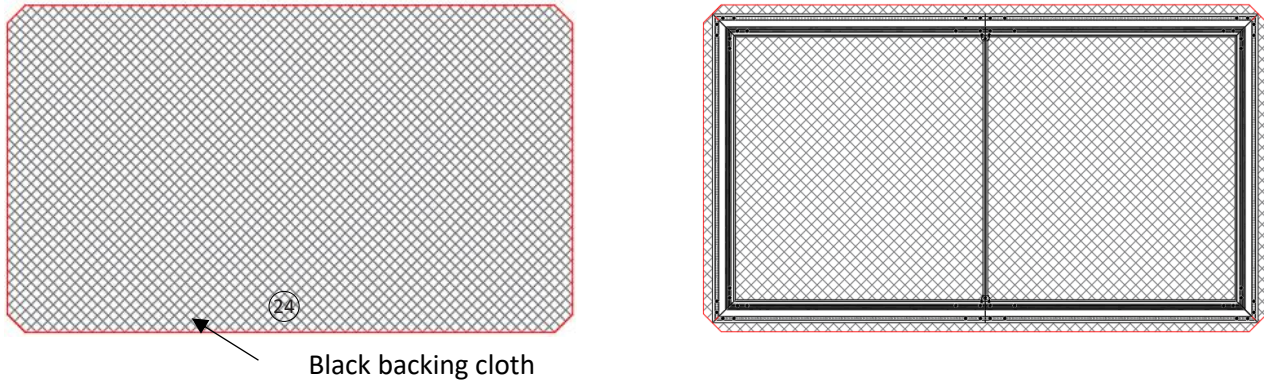

2. Stick the four corners of the black backing cloth to the Velcro on the frame according to 1→2→3→4 in sequence (Fold back black backing cloth to the back of the frame), the black backing cloth and the Velcro stucked together, then press with hands to make it more compact.
(Please noticed that the four sides of the black backing cloth can't go beyond the range of Velcro.)

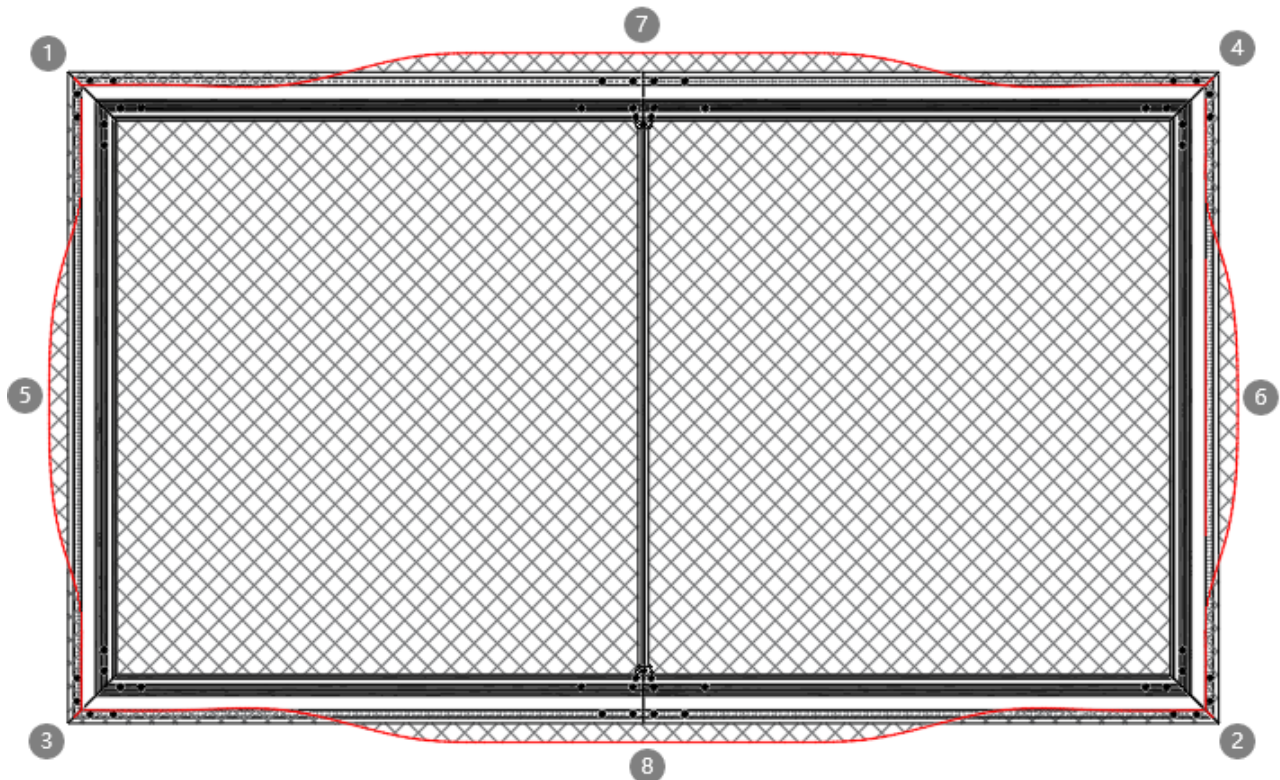

3. Do the same way for middle side of the frame, stick the middle of the black backing cloth to the Velcro on the frame according to 5→6→7→8 in sequence, the black backing cloth and the Velcro stucked together, then press with hands to make it more compact, and finished the installation of black backing cloth.
(Please noticed that the four sides of the black backing cloth can't go beyond the range of Velcro.)

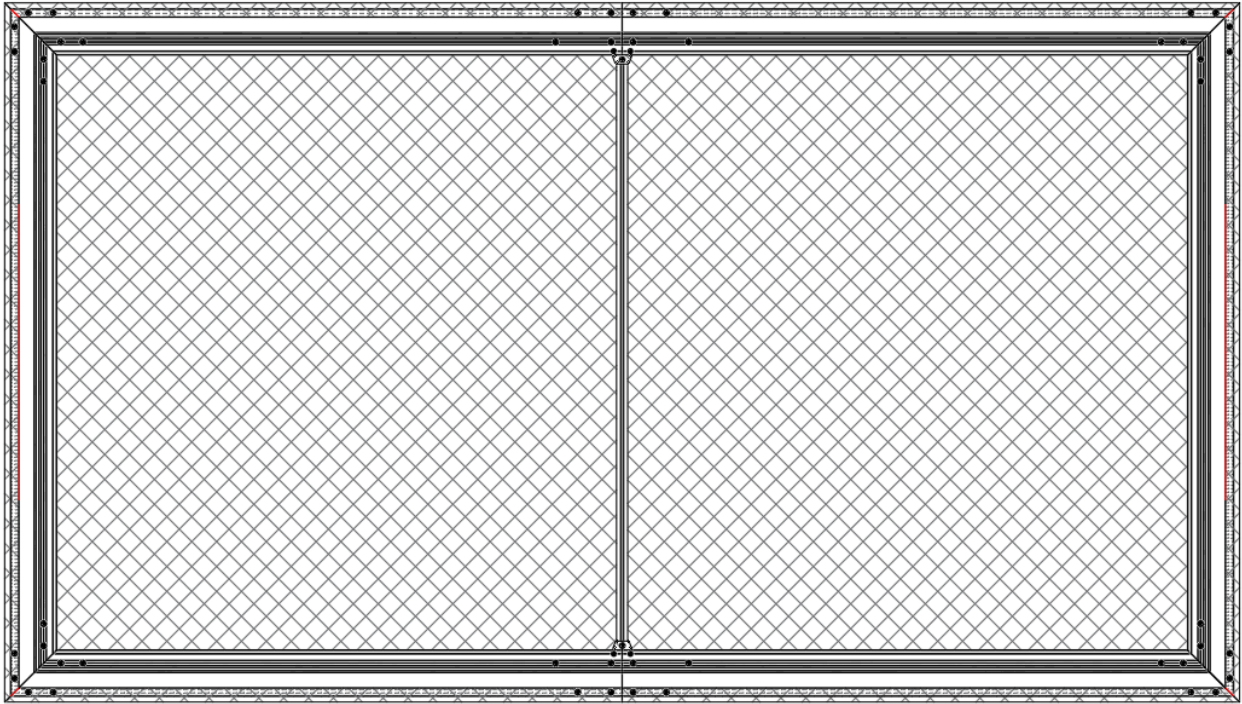

4. Screen Material Installation

ATTENTION: Put the gloves on when handling the screen material to avoid touching it with your bare hands.

※ Unrolling the screen material Two people recommended

- Put on the supplied pair of white gloves.
This is to avoid leaving oily handprints on the screen surface which are not removable.
- Remove the screen material from the tube and place a small suitable weighted object at the end of the material.
- Lay the material face down, two people carefully lift the rolled end and slowly rotate the material clockwise.
- Insert the corresponding fiberglass rods on thru the sleeves on the edges of the material.

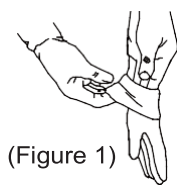

(Figure 1)

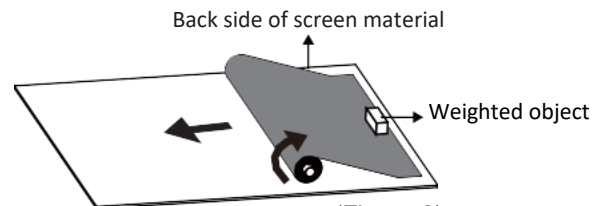

(Figure 2)

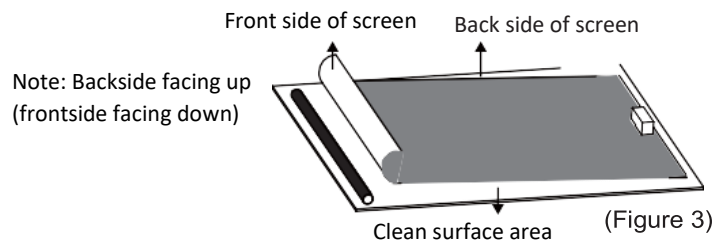

Note: Backside facing up
(frontside facing down)

(Figure 3)

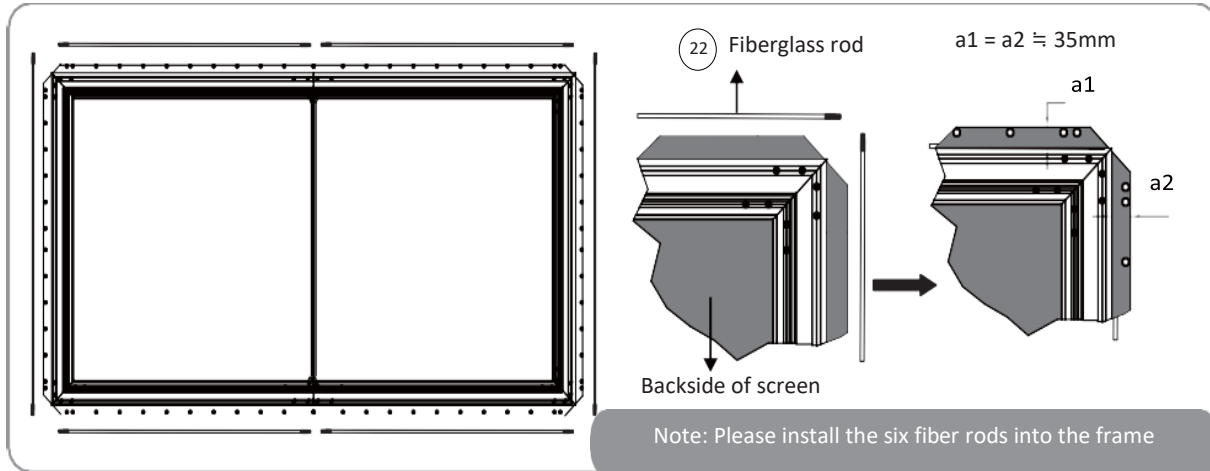

1. Carefully and gently place the assembled frame on top of the screen material.
DO NOT allow the angle edge of the frame to come in direct contact with the material to avoid puncturing it.

2. Adjust the distance between the edge of the frame and the material ($a1 = a2$) to 1.4"/35 mm

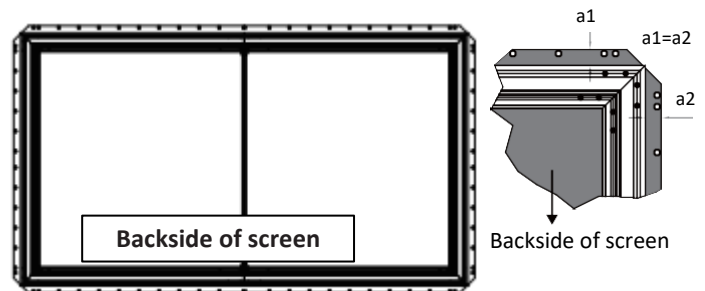

3. Begin by simultaneously attaching three springs in the center of the side frames (C→D) and repeat for top/bottom frames (A→B).

4. Then, simultaneously attach the springs from the center to all corners. (Leaving only the four corners.)

5. Finally, attach the springs at the four corners (E→F→G→H).

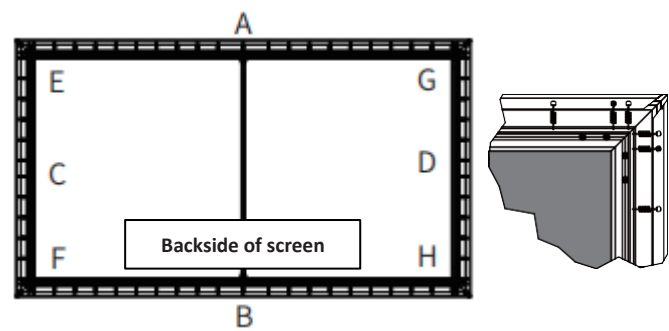

Spring Attachment Method

First hook one end of the spring in the frame slot, then hold the screen around the frame to pull, and finally use the spring hook to pull the spring hook in the screen hole.

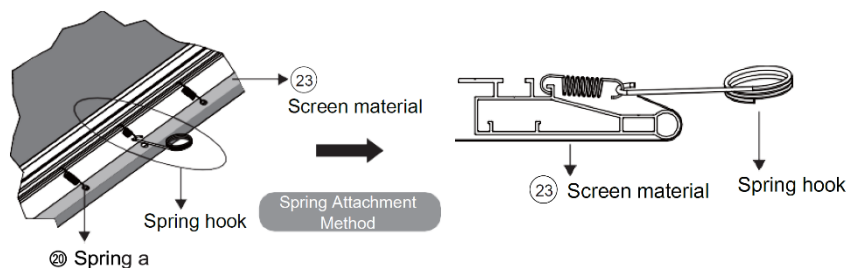

5. Bezel Trim Frame Assembly/Installation

1. Connect **Edge Trims A&B** to form the top/bottom trims with the **(8) Short Center joints**, and then insert them on the top/bottom frames.
2. Connect the **side edge trims C** with the top/bottom edge trim with **(15) Elbow Joints C**.
3. Adjust the trim so that the top and bottom trim pieces are touching and show no gaps on the corners. Then fasten them with the **(9) M4 x 4 screws**.
4. Attach a **(21) spring b** on the middle of each edge trim (1-6) to the frame as shown in the illustration.
5. Install the **(16) corner covers** on the four corners of the edge trim.

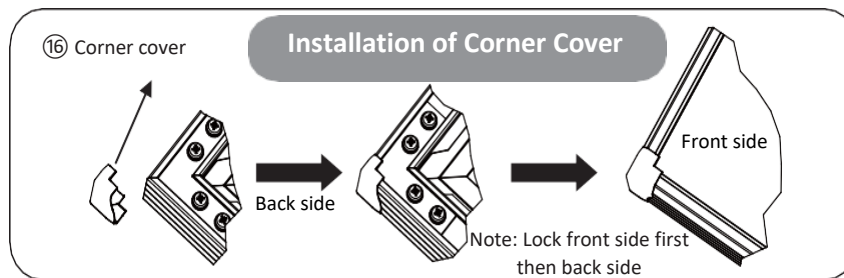
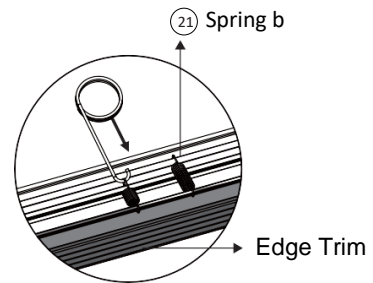
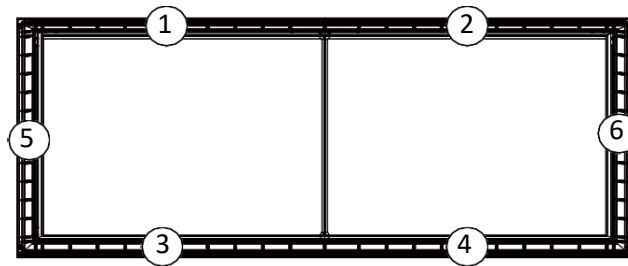
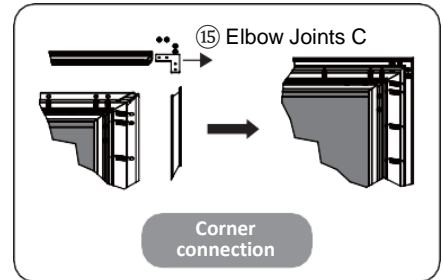
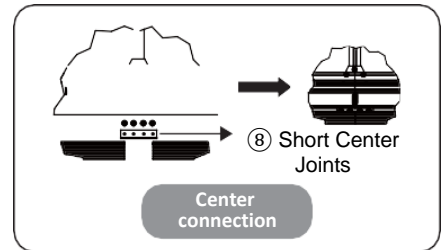
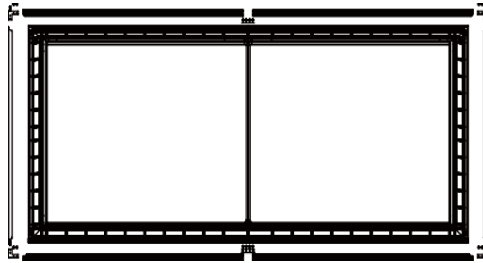

6. Product Dimensions



Note: The listed measurements are for general reference only.

Screen size	A	B	C	D
110"	96.7" / 2456 mm	95.9" / 2436 mm	54.7" / 1391 mm	53.9" / 1371 mm
125"	109.7" / 2788 mm	108.9" / 2768 mm	62.1" / 1578 mm	61.3" / 1558 mm
135"	118.5" / 3010 mm	117.7" / 2990 mm	67.0" / 1702 mm	66.2" / 1682 mm
150"	131.5" / 3342 mm	130.7" / 3322 mm	74.3" / 1889 mm	73.5" / 1869 mm

*Tolerance may be $\pm 1''$

7. Wall installation

Drill a hole on the wall according to the distance on the chart below distance for your screen. Place the bracket on the holes and secure them using a Phillips screwdriver. If not installing into a structural wood stud, use a wall anchor, then screw in the M5x50 screws. Make sure the brackets are leveled.

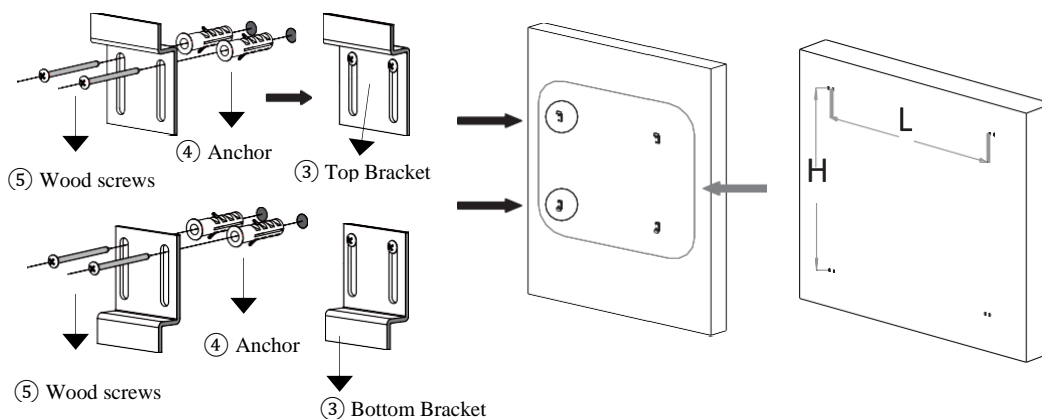

Screen size	110"	125"	135"	150"
L = Left/Right hole distance	59" / 1500 mm	78.7" / 2000 mm	78.7" / 2000 mm	98.4" / 2500 mm
H = Top/Bottom hole distance	47.5" / 1209 mm	54.9" / 1395 mm	59.8" / 1519 mm	67.1" / 1706 mm

Hanging the screen:

1. Two people hold the screen and align it first with the bottom bracket. The bracket lip must be inserted in the frame's channel per example below.
2. Then pull up the screen on the top bracket and adjust the screen left to right as needed.

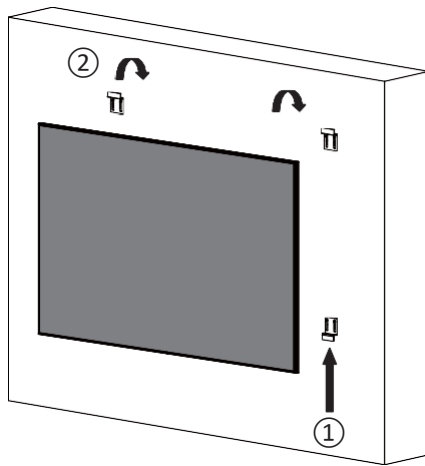

Frame installed on top bracket

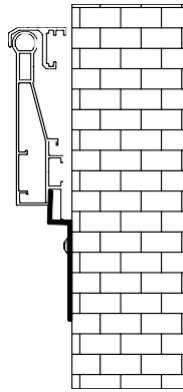

Frame installed on bottom bracket

Do not fasten the screws on the bottom bracket to allow screen to move up and

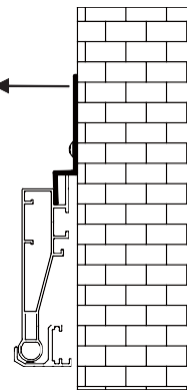

www.elitescreens.eu



AEON - CineGrey 5D

EDGE FREE® Ambient Light Rejecting Fixed Frame Screen

USER'S GUIDE

Version 2 (Spring type)





Product Description:

The **Aeon Series** is a fixed frame projection screen that uses Elite's EDGE FREE® technology. The EDGE FREE® design resembles a giant size flat panel TV display. The **Aeon** includes a bezel trim to further enhance the frame appearance and absorb projector overshoot.

The screen material included is our *CineGrey 5D ambient light rejecting material*, which is a front projection material precisely formulated for environments with minimal control over room lighting. It was designed to enhance picture brightness, offer accurate color fidelity, and improve contrast levels. The *CineGrey 5D* is best for family rooms, educational facilities, conference rooms or any applications in which incident light is a factor.

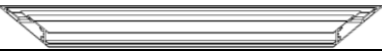
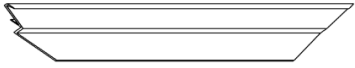
In order for the *CineGrey 5D* to maintain its projection qualities and optimum performance, please refer to the list below for proper maintenance and cleaning.

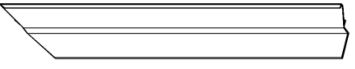
- Use a dry microfiber cloth to remove dust from the screen's surface.
- When cleaning, use a damp microfiber cloth with warm water to remove any marks.
- Never rub or apply pressure when cleaning the surface.
- Never attempt to use any solutions, chemicals or abrasive cleaners on the screen surface.
- In order to avoid damaging the screen, avoid touching it directly with your fingers, pens/pencils or any other sharp or abrasive objects.

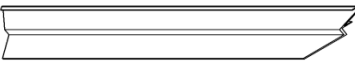
1. Frame and Edge Trim Parts List			
Qty item	2 pcs Main Frame Parts	Qty item	2 pcs Edge Trim Parts
Part A.	vertical frame 	Part D.	
Part B.	½ horizontal frame 	Part E.	
Part C.	½ horizontal frame 	Part F.	

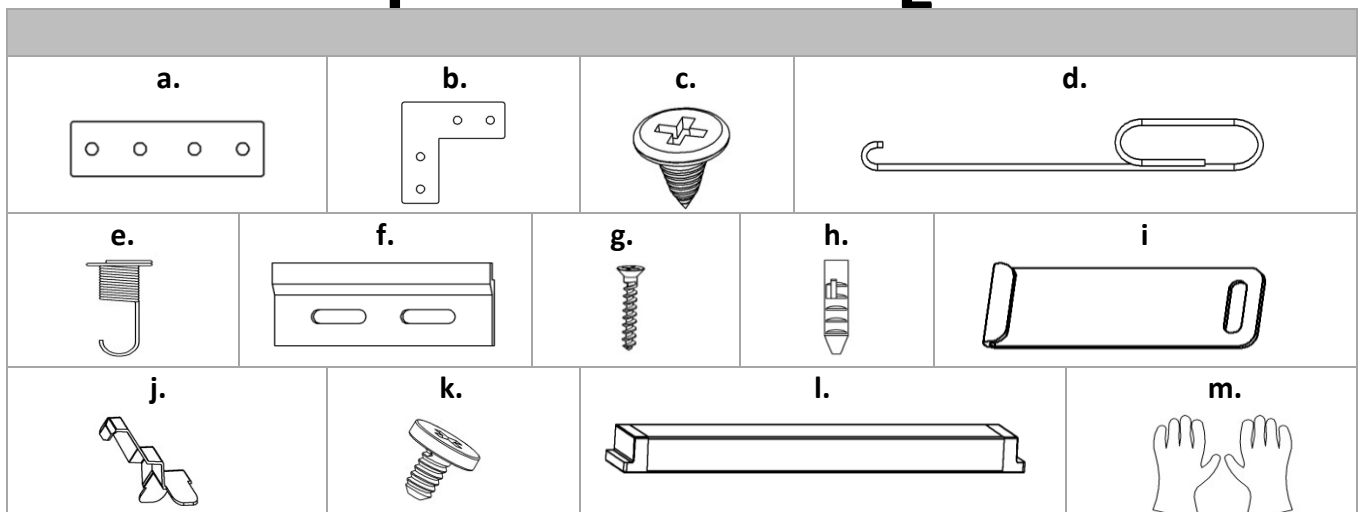
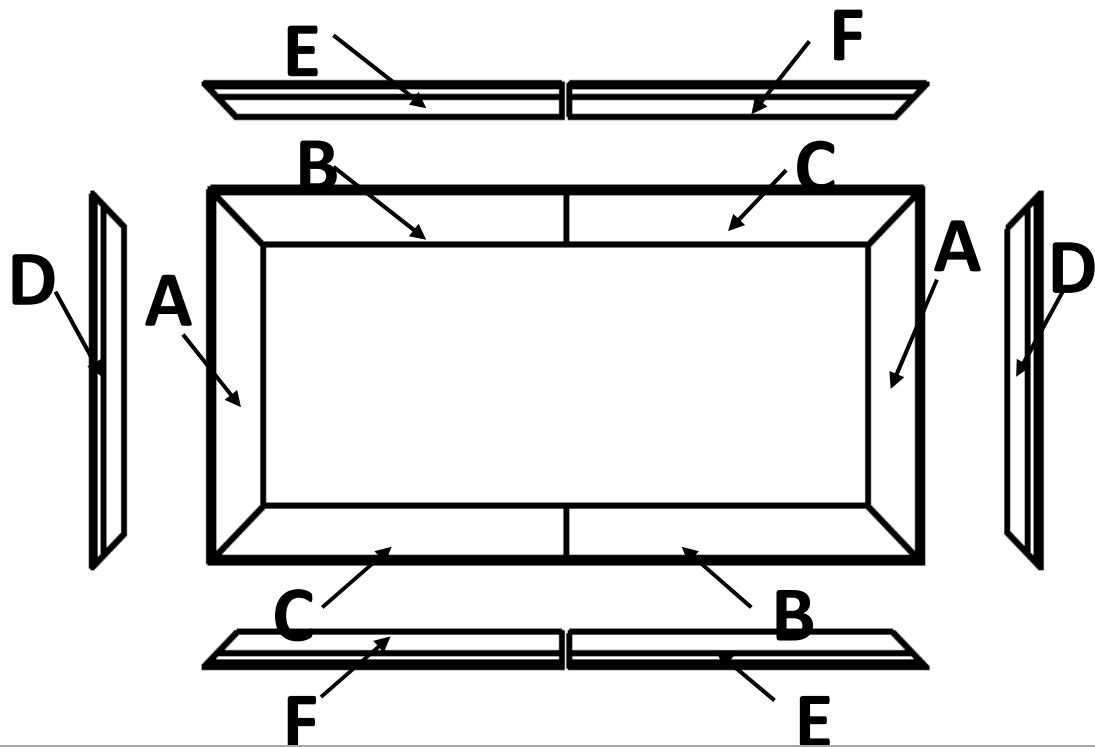

Item	Parts List	84H	100H	110H	120H	135H	150H	103C	125C	138C	158C
a.	Center Joints (1)	4	4	4	4	4	4	4	4	4	4
b.	Elbow Joints (2)	8	8	8	8	8	8	8	8	8	8
c.	M4x6 Screws	60	60	60	60	60	60	60	60	60	60
d.	Spring Hook	2	2	2	2	2	2	2	2	2	2
e.	Spring	72	92	96	104	116	128	88	104	116	134
f.	Top wall brackets	2	2	2	2	2	2	2	2	2	2
g.	Φ5x50 Wall Screws	6	6	6	6	6	6	6	6	6	6
h.	Hollow Wall anchors	6	6	6	6	6	6	6	6	6	6
i.	Bottom wall brackets	2	2	2	2	2	2	2	2	2	2
j.	Angle cover	4	4	4	4	4	4	4	4	4	4
k.	M4x7 Screws	8	8	8	8	8	8	8	8	8	8
l.	Center Support Bar	1	1	1	1	1	1	1	1	1	1
m.	White gloves	2	2	2	2	2	2	2	2	2	2

Frame Assembly

Step 1: Place the soft padded EPE sponge on a clean area on the ground where the screen will be assembled.

Step 2: Position the pieces of the frame on the EPE sponge in the arrangement shown below

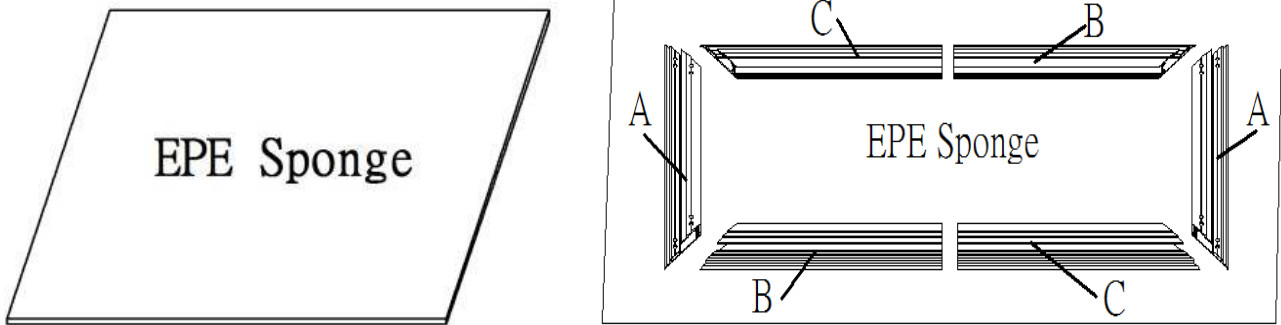

Step 3: Remove the tape on all frame ends before assembling the frame.

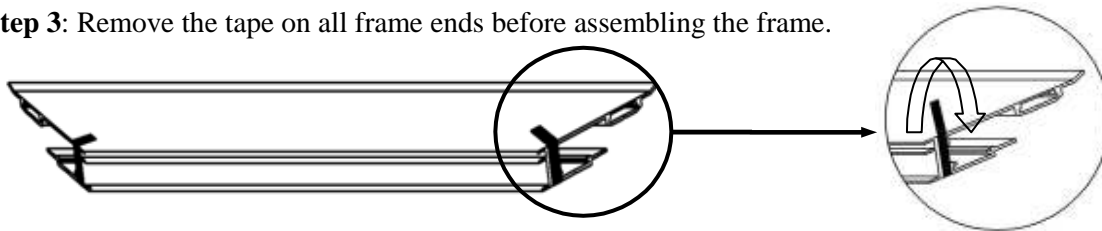

Step 4: Insert the *center joint (a)* connectors into *one-half of the horizontal frame (b/c)* and secure with the *M4x6 screws (c)*.

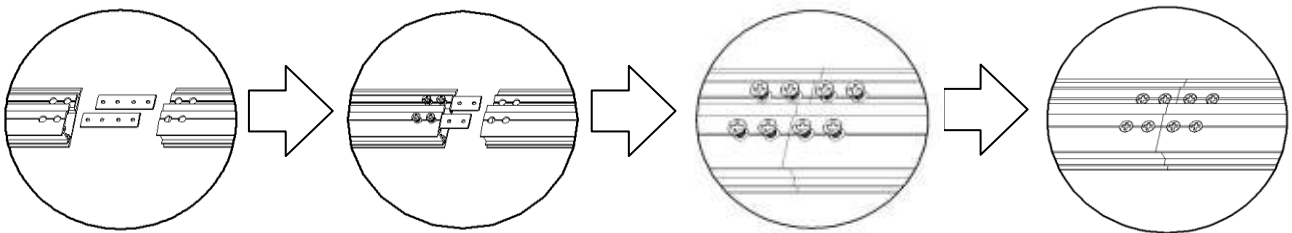

Step 5: Insert the *springs (e)* into the grooves of the frame. The spring's hooks should be facing the front side of the frame. For the correct amount of springs to place into the frame, please refer to the table listed below.

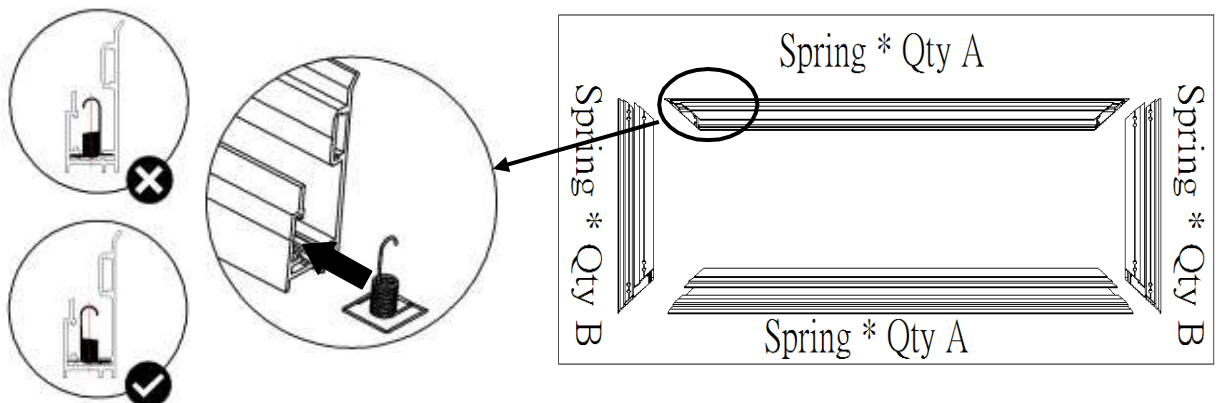

Note: The springs are pre-installed into the grooves of the frame.

Screen Size		84H	100H	110H	120H	135H	150H	103C	125C	138C	158C
Spring Qty	A	23	29	31	33	37	41	31	37	41	47
	B	13	17	17	19	21	23	13	15	17	20

Step 6: Connect the *elbow joints (b)* to the top and bottom sections of the vertical frame. Once inserted, connect the vertical sections of the horizontal frame sections. Make sure all holes are in alignment and the frame pieces are flush (no gaps). They should form perfect right angles.

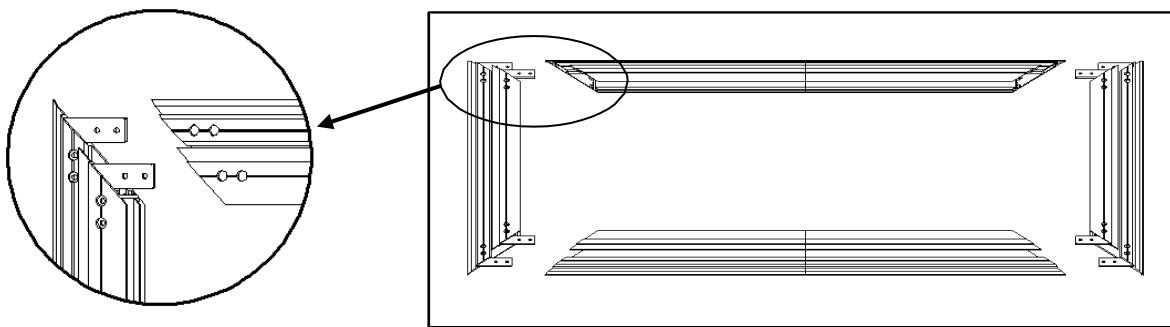

Step 7: Secure the elbow joints by fastening them with *M4x6 screws (c)*, 4 at each corner.

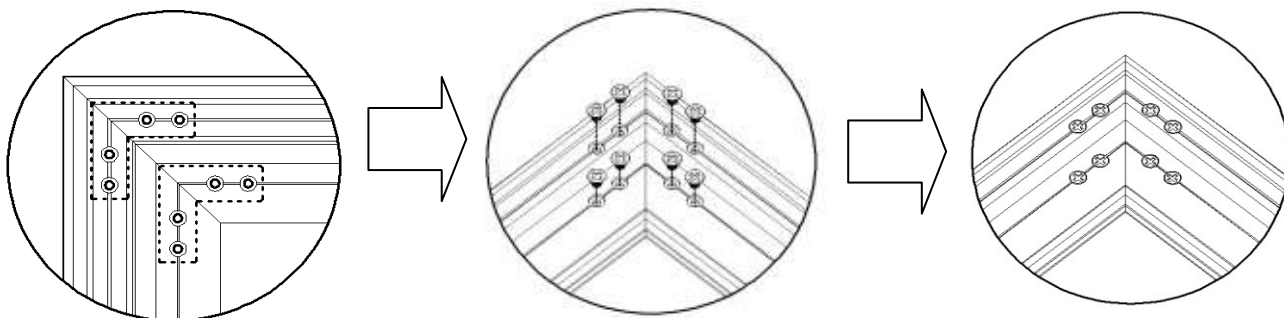

Screen Material

Step 8: Put on the *white gloves (m)* and carefully unroll the screen material on a clean surface from the roller to the other side as shown below. The back side of the screen material should be placed upwards.

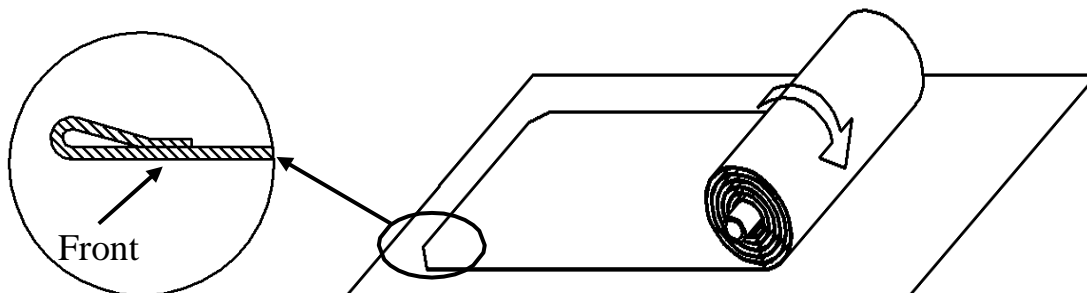

Step 9: Carefully and gently place the assembled frame on top of the screen material. Make sure to not allow the angle edge of the frame to come in direct contact with the screen material to avoid puncturing it.

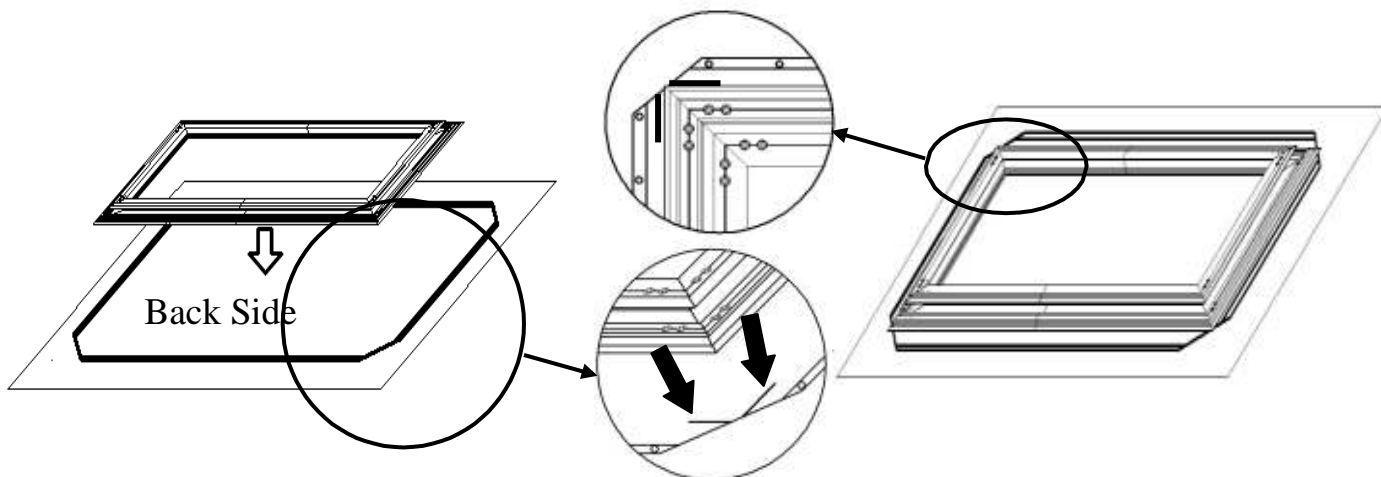

Step 10: With one end of the spring and secure inside the groove of the frame, use the *spring hook (d)* to attach the spring to the hole located on the screen material's outer edge in the following order.

Attach the four corners first (1). After those are secure, connect the vertical portions of the material, begin in the center and move towards the corners (2). Lastly, connect the horizontal sections of the material by connecting the center of the material and make your way towards the corners (3).

Note (after all springs have been attached):

Correct material installation –Corners of the screen material are properly wrapped around the corner edges of the frame and material is evenly tensioned and flat, creating a nicely taut surface.

Incorrect material installation –The corners of the screen material are not properly wrapped along the edge of the frame leaving the material with unbalanced tension and an uneven finish. To correct, detach springs from material at the corner(s) where material does not lie flat along the edge of the frame, reposition the material so that it lies flat and wraps along the edge of the frame, and reattach springs to the material.

Note:Please make note of the yellow label and spring in the center of the frame. This is an indicator to start the screen material installation process from the middle area of the frame.

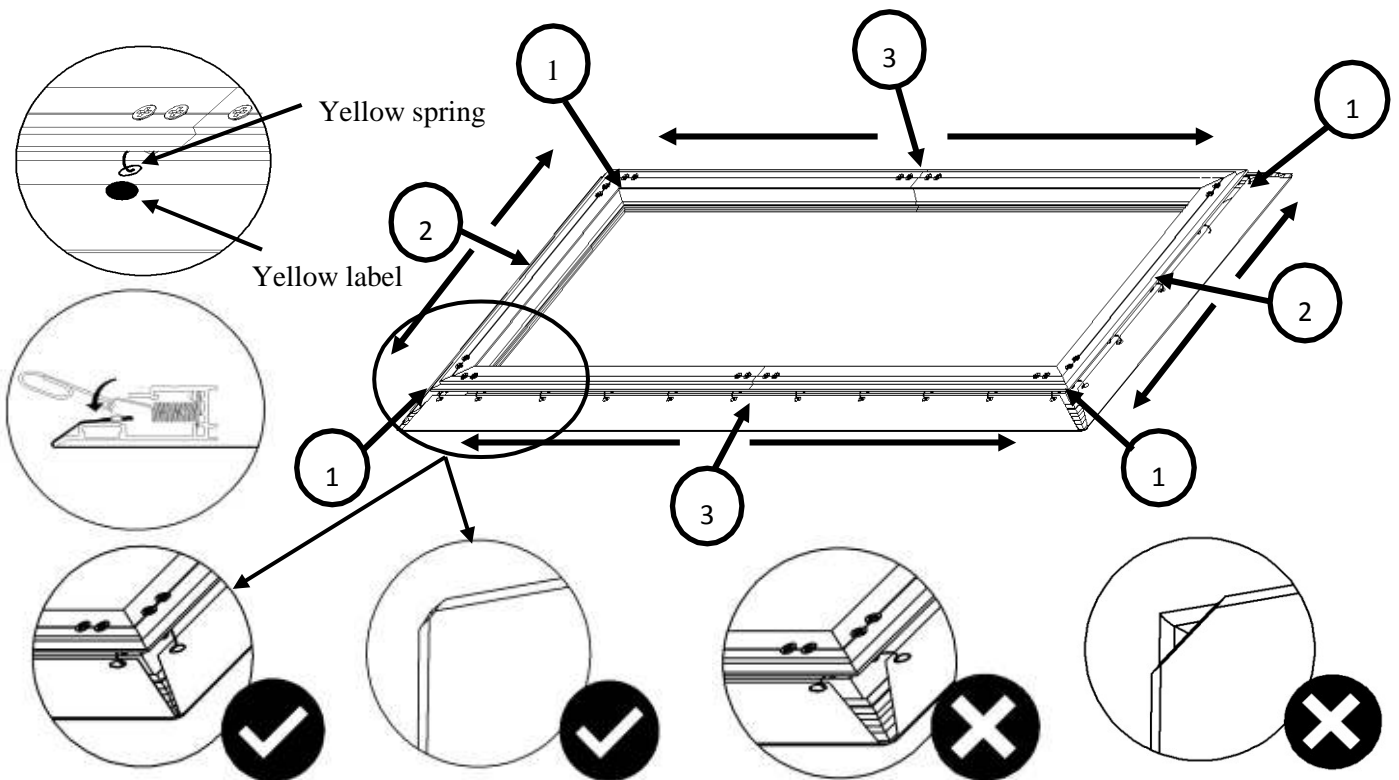

To avoid ripples forming in the material it is imperative that all of the corners are properly wrapped around the edges as illustrated in the check mark diagrams.

Center Support Bar

Step 11: Insert the *Center Support Bar (i)* into the upper top groove on the back of the frame with the bottom end near the approximate center point of the frame and rotate it in at an angle so that both ends of the bar are in alignment with the groove.

Diagonal Models 150" and below use 1 x Center Support Bar

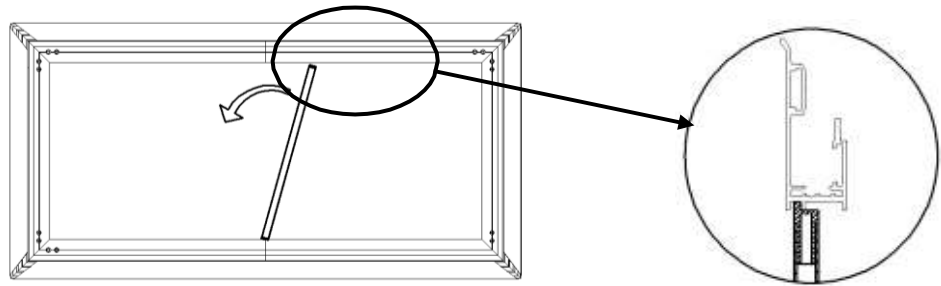

Diagonal Models above 150" require 2 x Center Support Bars

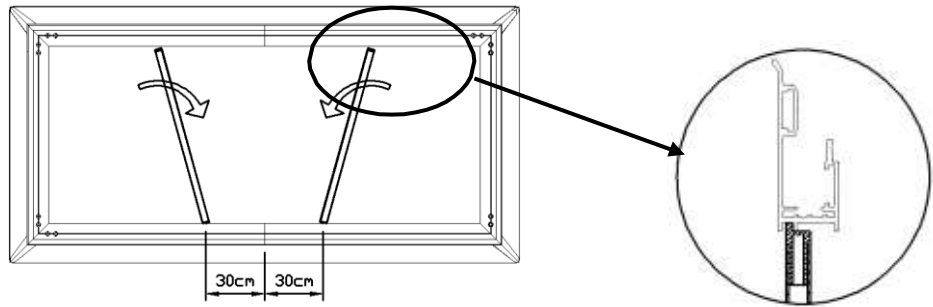

Attention: Do not proceed with the Edge Trim installation until making sure there are no ripples in the material.

Edge Trim Installation

Step 12: Place the *Edge Trim* over each end of the frame and secure with *M4x6 screws (c)*.

Start with the center points first, then the rest of the corners as shown below.

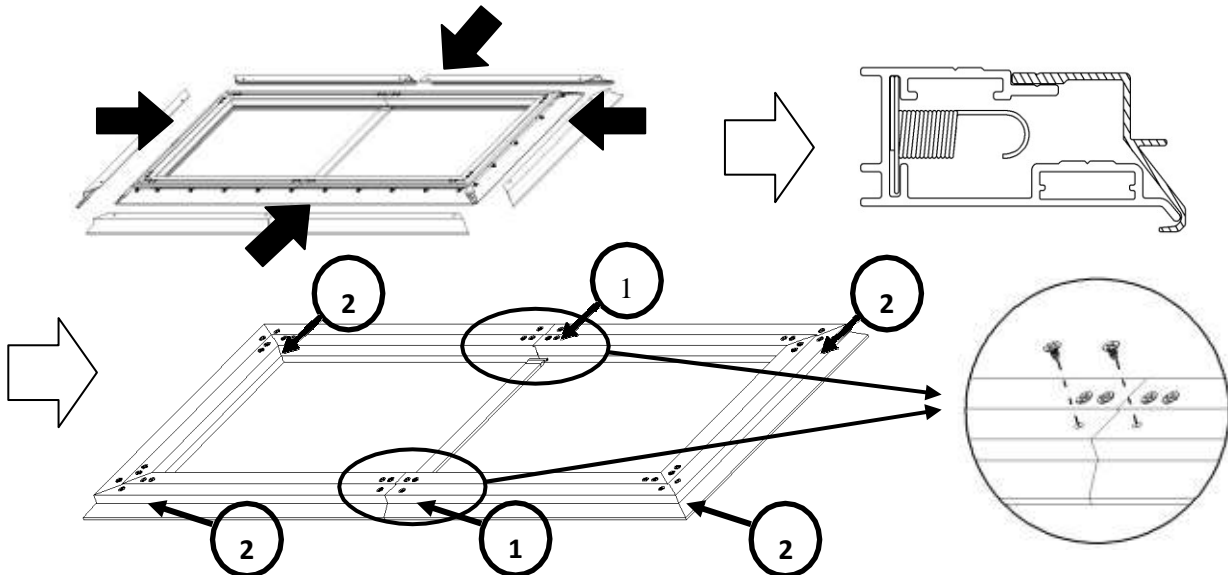

Step 13: Install the *angle cover (j)* on each corner of the frame and install the M4x7 screws to hold down the angle cover.

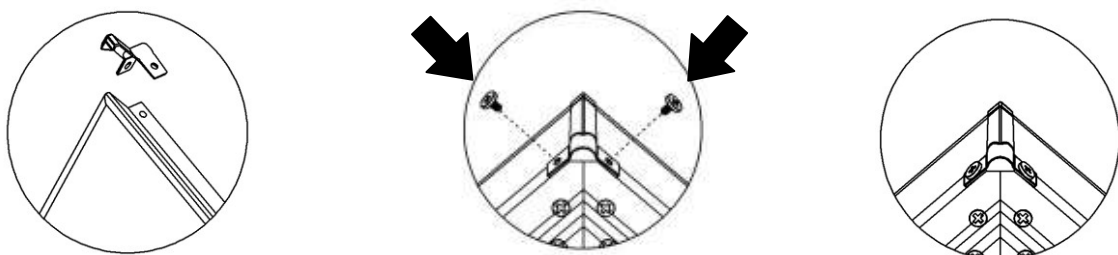

Notice to Installer:

Please use the following installation instructions to obtain superior optical performance from the CineGrey 5D Angular Reflective ALR (Ambient Light Rejecting) Screen.

Make sure to follow these instructions in order for the CineGrey 5D to perform correctly.

- Angular-Reflective material is not compatible with ultra/short-throw projectors
- Minimum lens throw ratio 1.5x image width
- Ambient light must not come from the same direction as the projector

Since angular-reflective means that the projected image will reflect at the mirror-opposite angle, it is important to position the projector so that the viewer will get the best possible image.

Step 1: Establish the general “eye level” of the viewers

Step 2: Set the appropriate projection level

Step 3: Adjust the screen height level and projection angle

Input Angle (A) = Output Angle (B) aligns with the viewer’s angle

Correct Installation Examples

Projector Ceiling Installation: Make sure the projector (*light in*) is angled (A) to reflect (B) at the mirror-opposite angle (*light out*) to align with the viewer’s eye level.

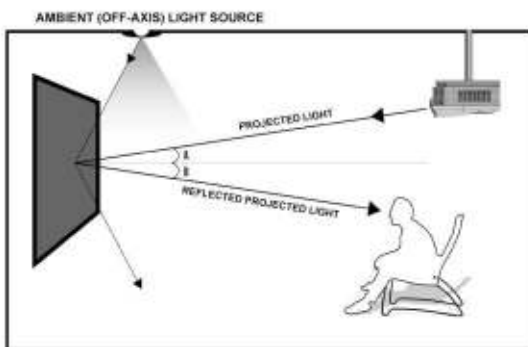

Projector Table Top: Make sure the projector (*light in*) is angled (A) to reflect (B) at the mirror-opposite angle (*light out*) to align with the viewer’s eye level.

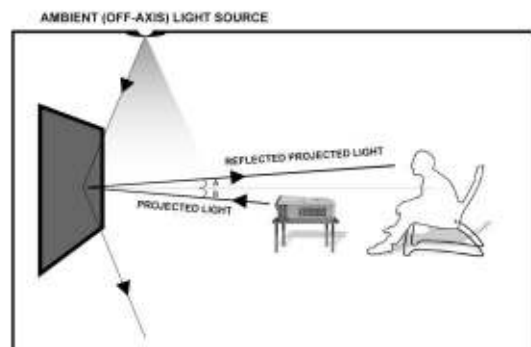

Incorrect Installation Examples

Ceiling Mounted Short-throw Projector

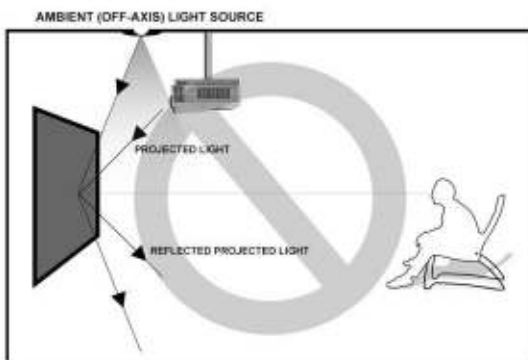

Tabletop Ultra-Short throw Projector

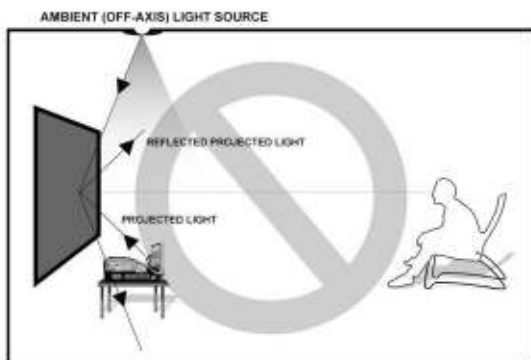

Note: Improper installation will result in light loss and produce a dark image. This is due to the projector’s light reflecting in the wrong direction.
Images are not up to scale and are for illustration purposes only.

Wall Installation

Step 14: Measure the overall length and height of the frame and drill holes for the top brackets. Line up the wall brackets with the drilled holes on the installation location and screw them in using a Phillips screwdriver. If not installing into a structural wood stud, use a hollow wall anchor then screw in the M5x50 wood screws with a screwdriver. Make sure the brackets are leveled.

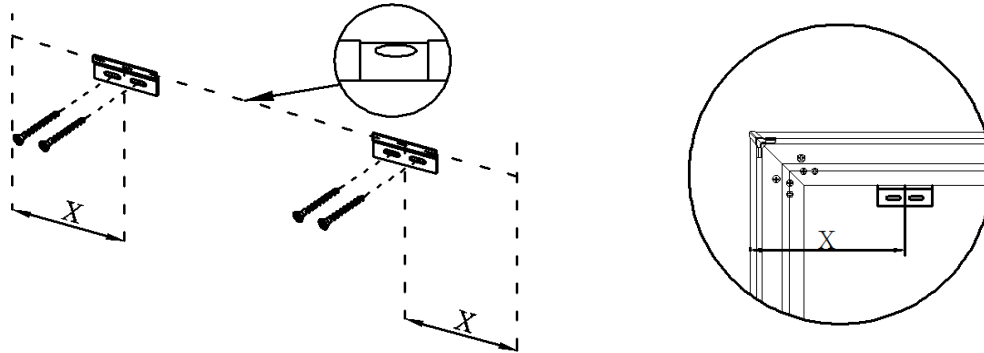

Step 15: Position the fixed frame screen onto the top wall brackets as shown below and push down at the center of the top of the frame to secure.

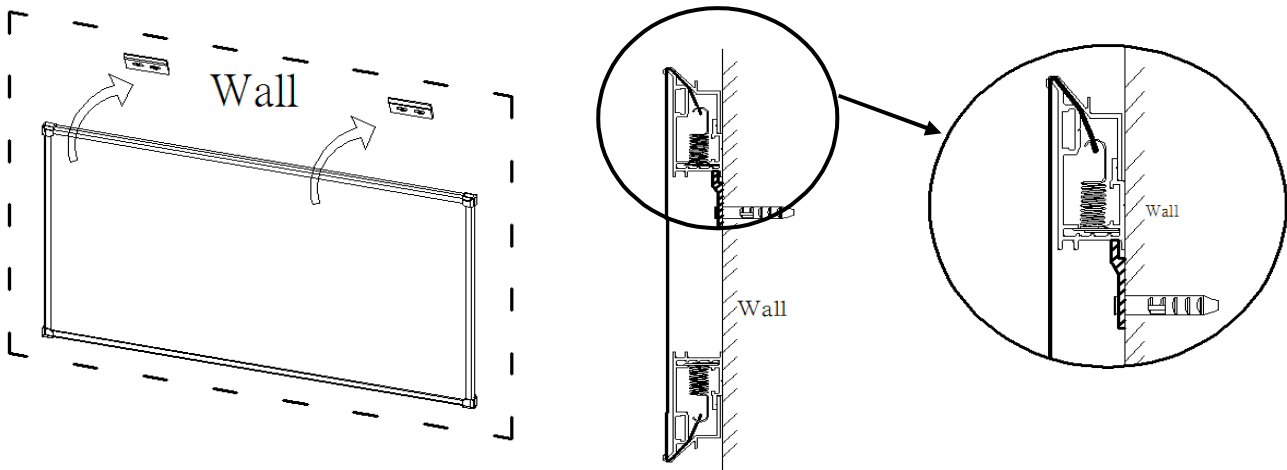

Step 16: With the frame slightly tilted outward; connect the bottom brackets onto the bottom groove of the frame. Then secure them by screwing onto the wall

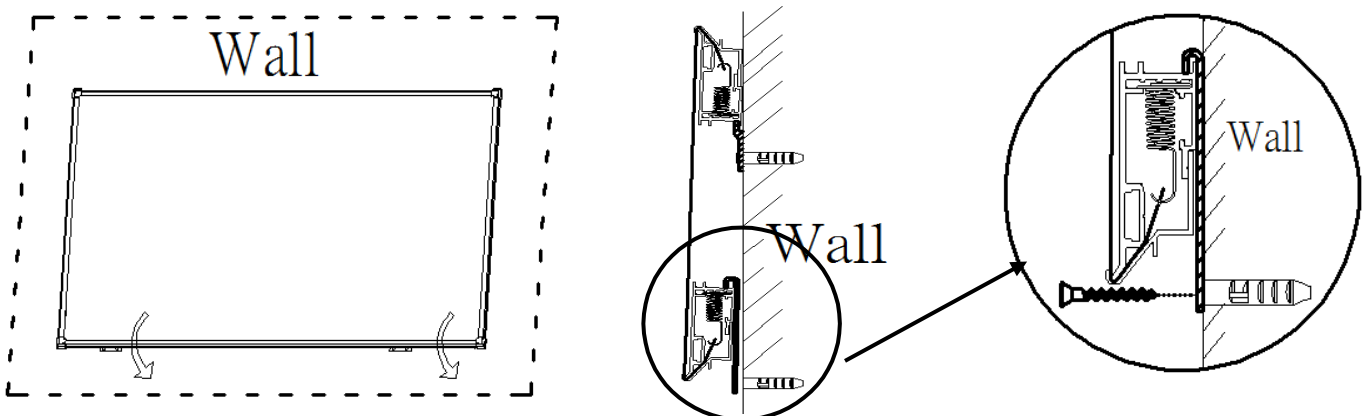

For Technical Support or an Elite Screens contact in your area, visit

www.elitescreens.eu



AEON - CineGrey 3D

EDGE FREE® Fixed Frame Projection Screen









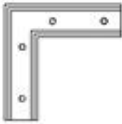

User's Guide

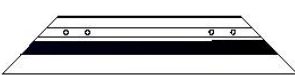
Applies to all available screen materials:  CineGrey 3D® EDGE FREE® and CineWhite® EDGE FREE®

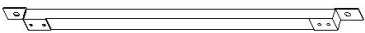
Product Description: The Aeon Series is a fixed frame projection screen that uses Elite's EDGE FREE® technology. The EDGE FREE® design resembles a giant size flat panel TV display. The Aeon includes an ultra-thin trim as an installation option to further enhance the frame appearance and absorb projector overshoot. An optional LED backlighting kit is available for added visual appearance.

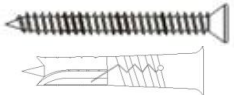
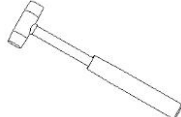
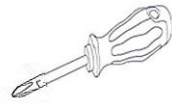
Hardware and Parts List

Please make sure all parts listed below are included before installation.

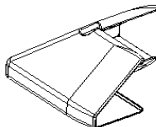
<p>A. Elbow joint x4 pcs</p>	<p>B. Top/Bottom horizontal frame x4 pcs</p>	<p>C. Left/Right vertical frame x2 pcs</p>	<p>D. Center joints x2 pcs</p>
			
<p>E. Center Support bar x1-3 pcs</p>	<p>F. Wall brackets x2-3 pcs</p>	<p>G. M5x15 screw x24 pcs</p>	<p>H. M5x50 screws and anchor x6 pcs</p>
 <p>(135"-150" x2 pcs; 180"-200" x3 pcs)</p>			
<p>I. Rubber hammer x1 pc</p>	<p>J. Screwdriver x1 pc</p>	<p>K. Black Tape x1 bag</p>	<p>L. Bezel trim x6 pcs</p>
			
<p>M. Corner Support Bar (180"-200") x4 pcs</p>	<p>N. Corner sleeve x4 pcs</p>		
			

Frame Assembly

1. Insert the center joint into one of the $\frac{1}{2}$ *horizontal frames (B)* and fasten it with the two *M5x15 screws (G)*.
2. Insert the other $\frac{1}{2}$ horizontal frame piece to the center joint and fasten also using two *M5x15 screws*.
3. Repeat steps 1 and 2 for assembling the second horizontal frame.

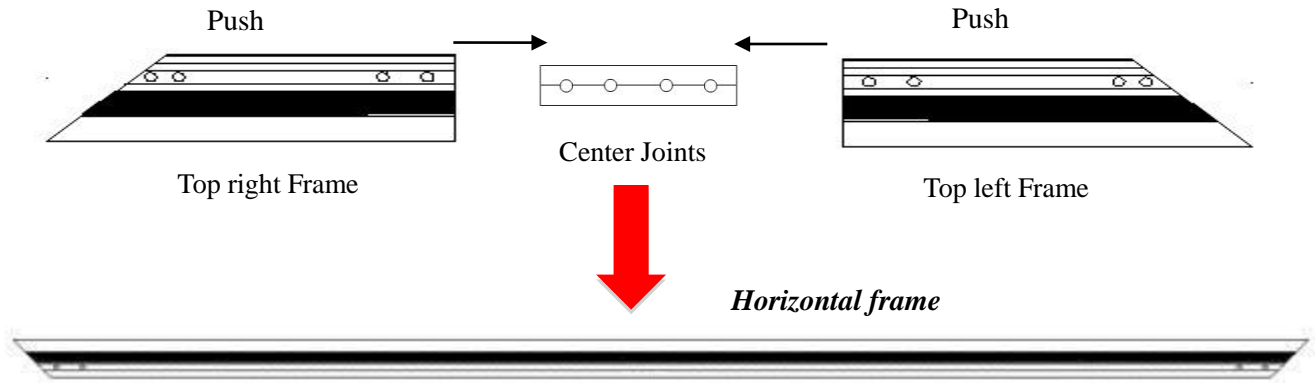

4. Insert the *elbow joint (A)* into each end of the *horizontal frames (B)* as shown below.

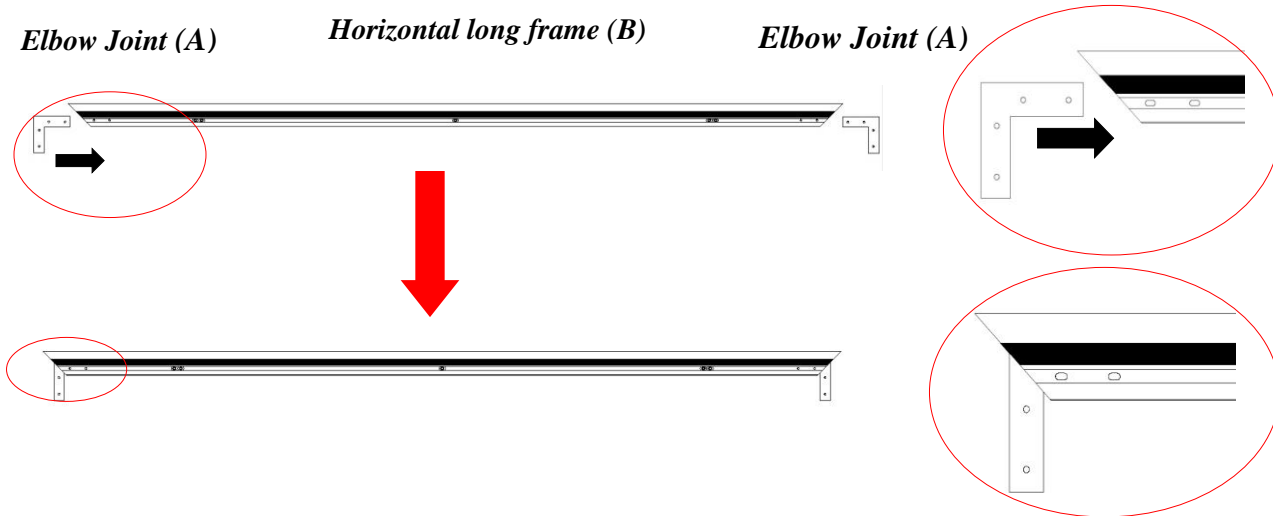

5. Insert the two *vertical short frames (C)* into the *elbow joint (A)*.

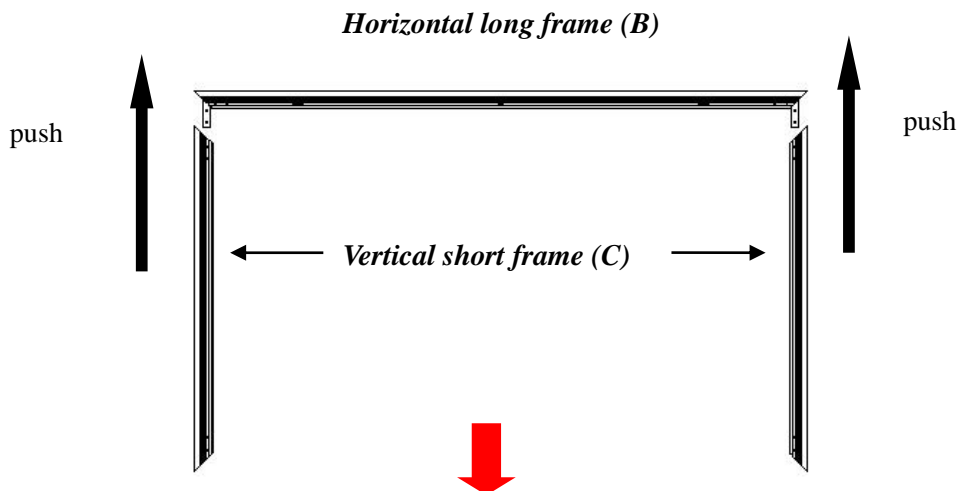



6. Join the remaining *horizontal long frame (B)* with the frame built in the previous steps as shown below.

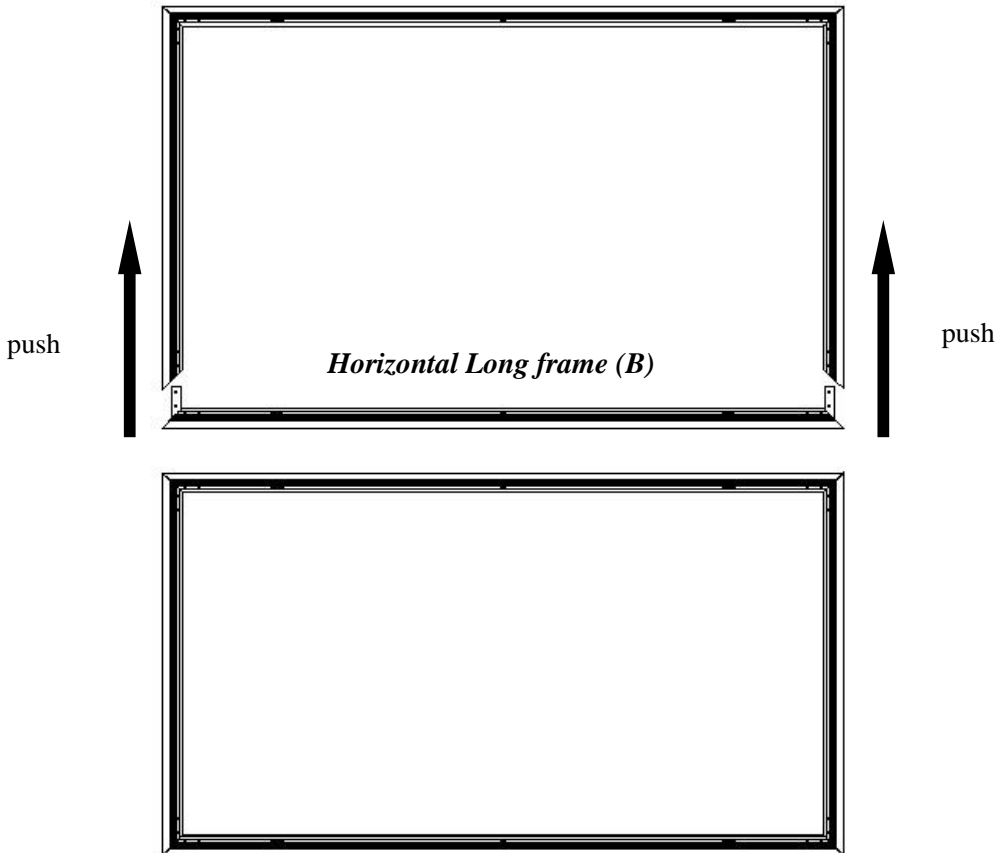

7. Make sure all four corners are properly in place to form a perfect square. Then fasten the four angles with the *M5x15 Screws (G)*.

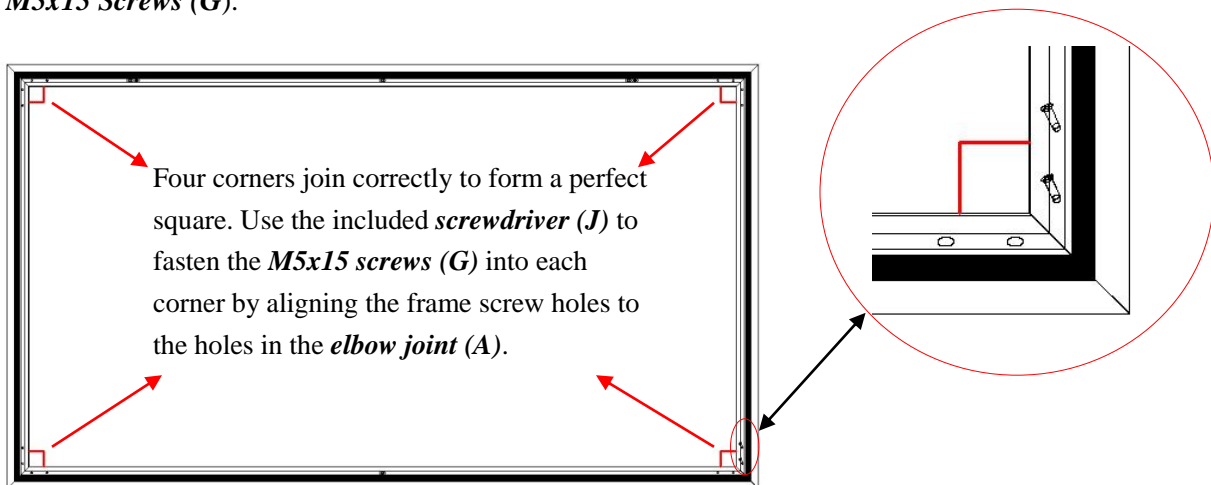

Screen Material Installation

1. Lay the *screen material* completely flat with the front facing down on a clean surface in a horizontal position. The back side of the screen material should be placed upwards.

Note: The back side of the material has the velcro borders all around the edges.

2. Carefully and gently place the assembled frame on top the screen material as shown below. Make sure to not allow the angle edge of the frame to come in direct contact with the screen material to avoid puncturing it.

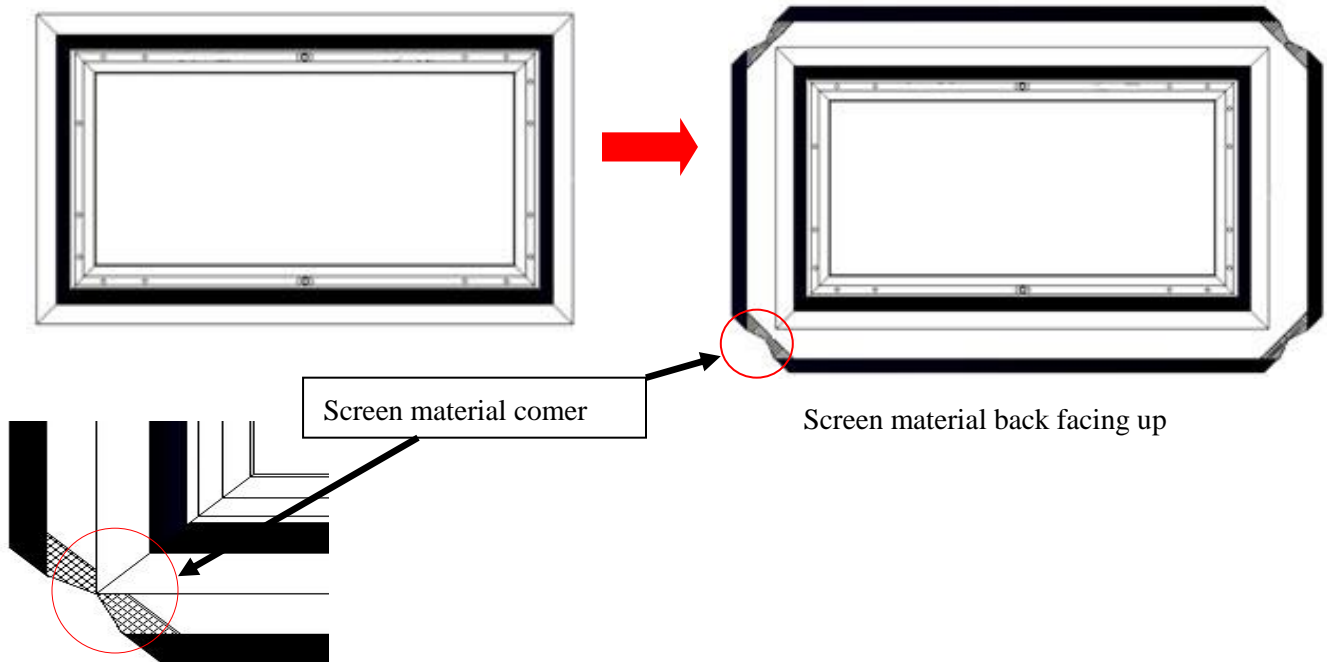

3. After all of the corners of the frame have been properly aligned, attach the material to the frame in the following order A→B→C→D (see instructions below for details).

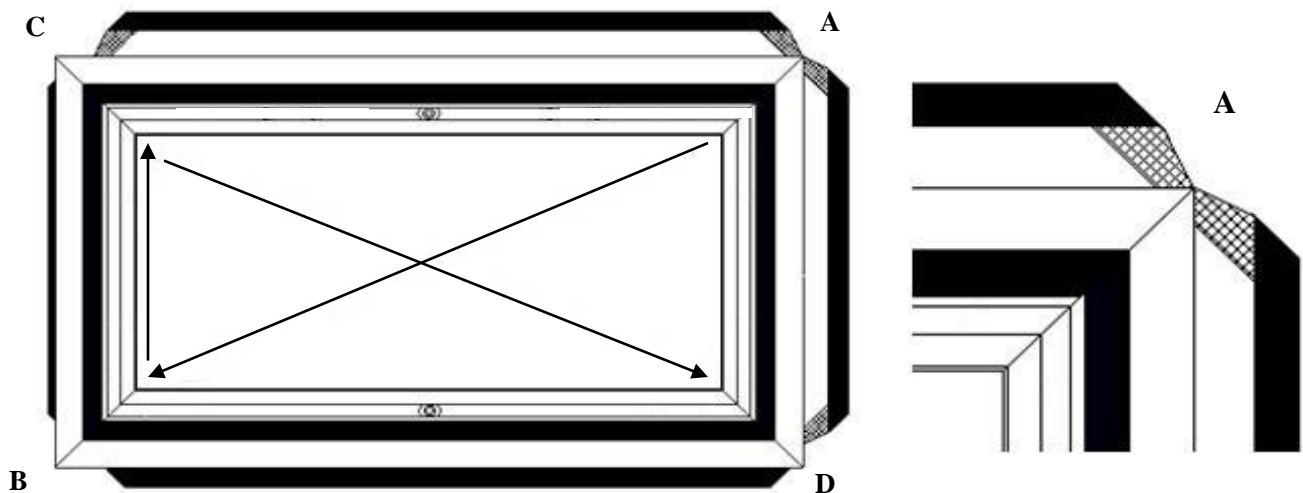

Attach the screen material to the corners as shown below.

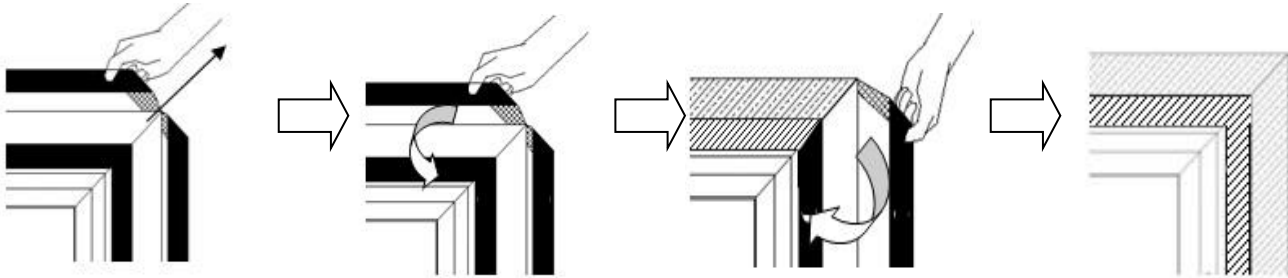

1) Stretch the screen material in the direction of the arrowhead.

2) Fold over and attach material to the velcro strip of the frame.

3) Fold over second side and attach to frame

4) Repeat until all four sides are done in the order A, B, C, D

4. After all four corners have been attached; please check whether the frame corners are wrapped by the screen material. If not, please loosen the velcro connection and repeat the above steps so the frame is not exposed.

Note:
Represents the screen material

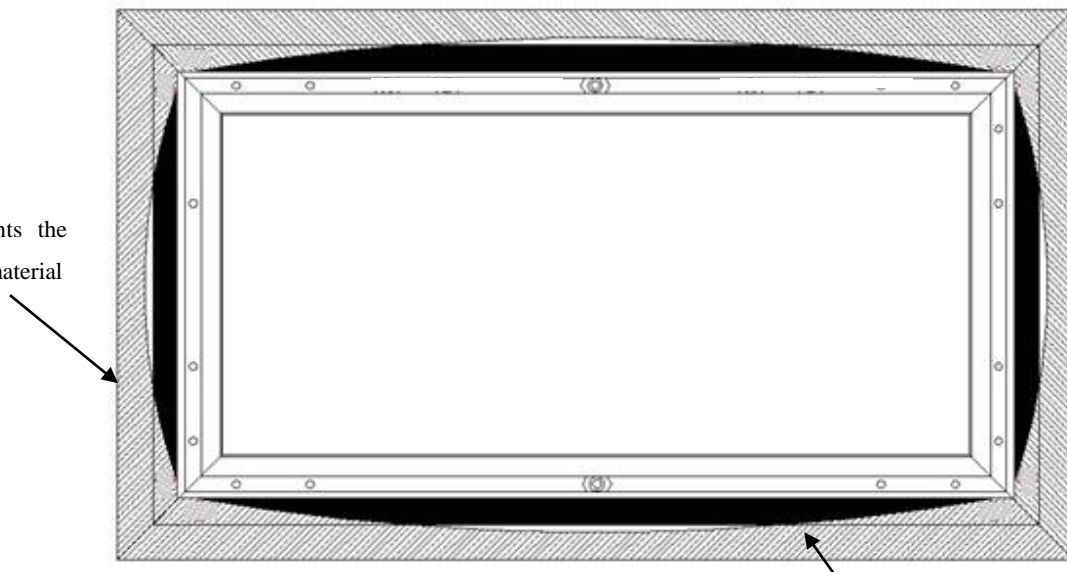

Note: The black shaded part represents the velcro on the frame. That Velcro end will ultimately attach with the other velcro end on the screen material.

5. Proceed to attach the rest of the material to the frame as described in the illustrations below.

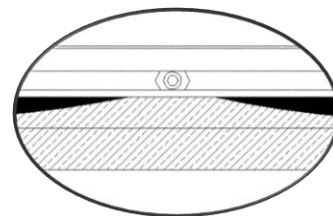
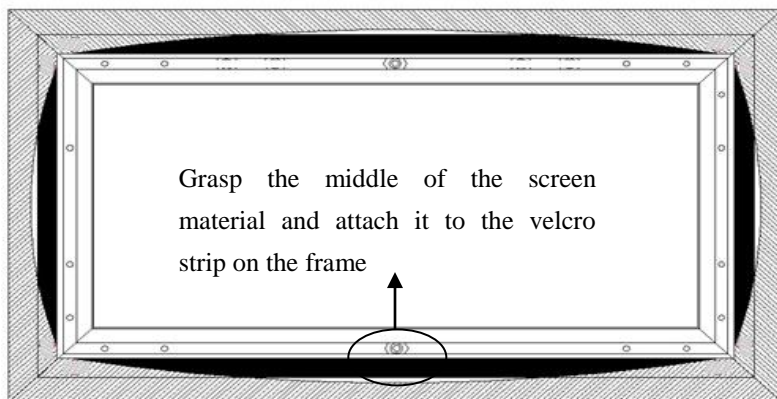

Lay the Velcro end on the screen material over the Velcro end of the frame and keep it within the edge.

Proceed in the following sequence below ①→②



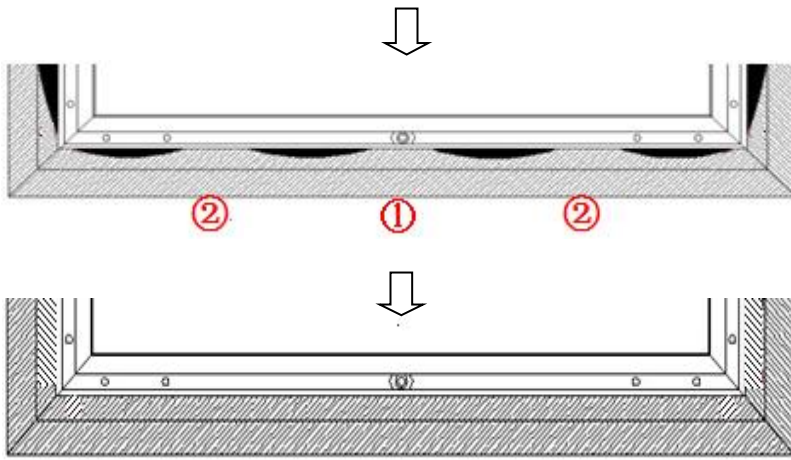

The key is to attach within the middle sections of 1 and 2. Then continue attaching the remaining unattached areas.

Repeat the same steps on remaining three sides in the sequence A, B, C, and then D as show below.

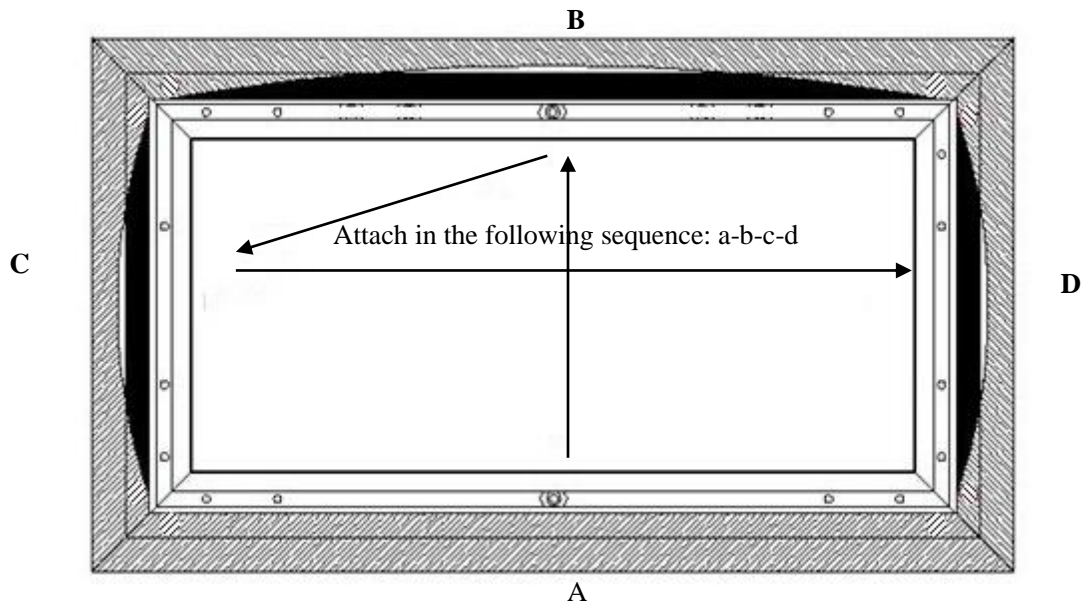

6. If the material is too loose or tight after adjusting all four corner sides, then you will need to reattach the material. *Please follow the steps below to properly remove the screen material from the frame. This procedure will ensure prolonging the life of the screen material.*

Screen Material Removal

1. Detach the velcro from the frame.
2. Gently pull back the material to release it from the velcro connections on the corners

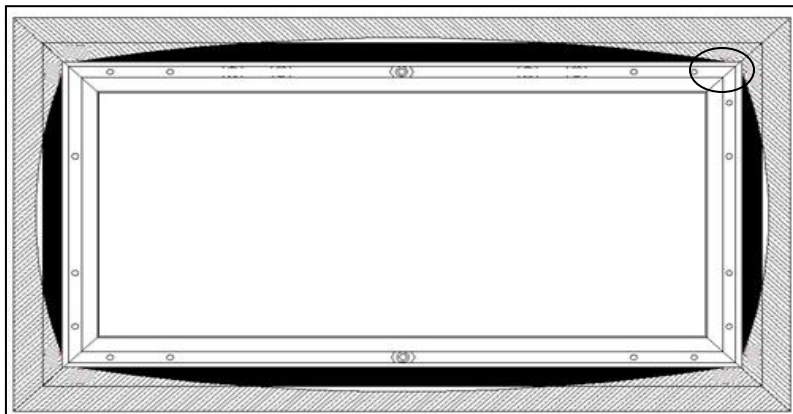

Pull back the screen material from the velcro connection along the edges of the frame to detach it.

Support bar installation (for models under 135")

1. Position the *center support bar (E)* in the middle of the frame and align the hole on each end of the support bar with the *M6 hex screws* on the top and bottom frames. Then fasten with the *M6x12 screws*.

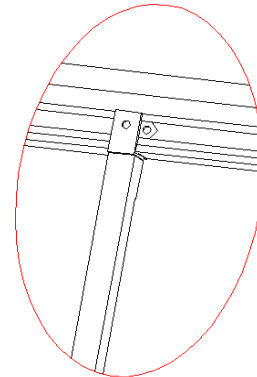
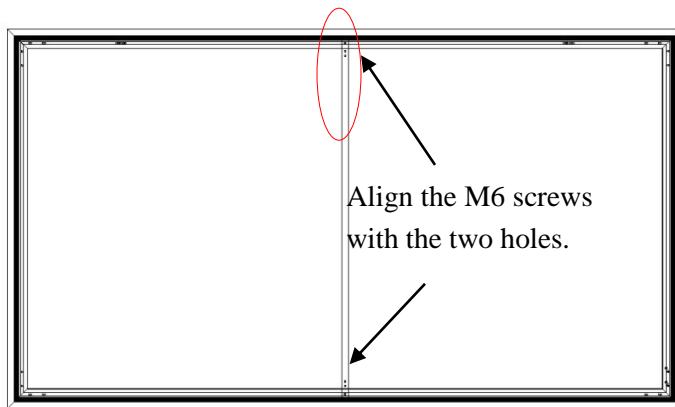
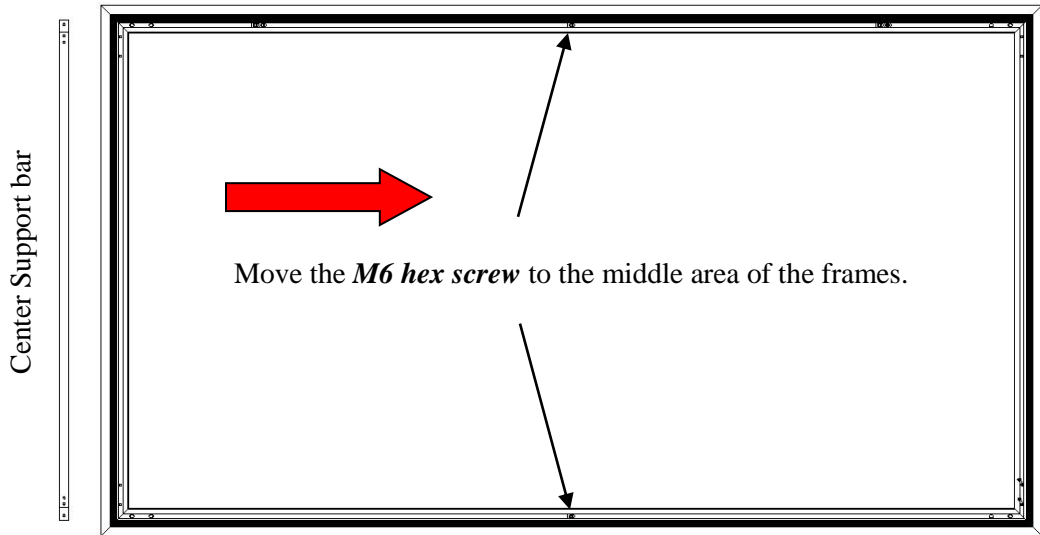

Support bar installation (for models 135"- 150")

1. Position the *center support bar (E)* and *M6 hex screws* in the areas of the frame shown in fig 1. (Each about one thirds the way in from the end of the frame.) Align the hole on each end of the support bar with the *M6 hex screws* located at the top and bottom frame sections. Then fasten with the *M6x12 screws*.

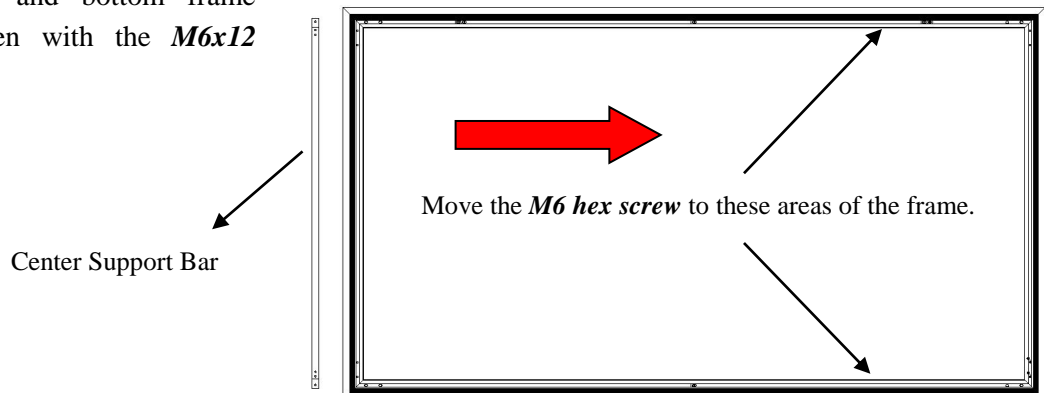

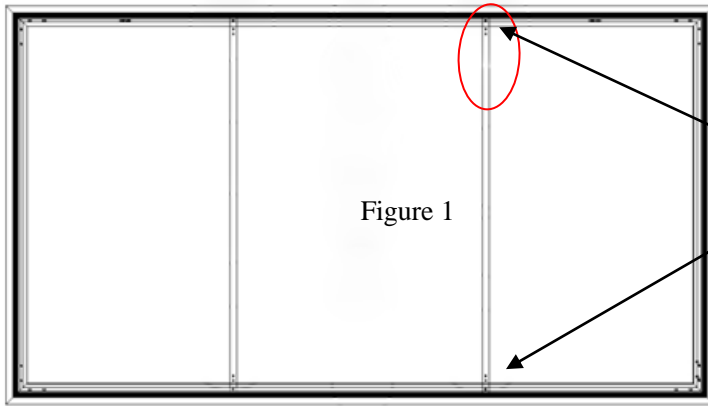
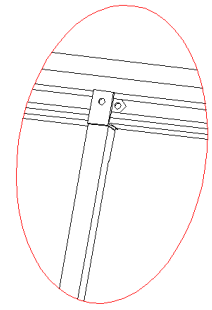

Figure 1

Align the M6 Screws with the two holes located on the Center Support Bar.



Support bar installation (for models 180"- 200")

2. Position the *center support bar (E)* and *M6 hex screws* in the areas of the frame shown in fig 1. Align the hole on each end of the support bar with the *M6 hex screws* located at the top and bottom frame sections. Then fasten with the *M6x12 screws*.

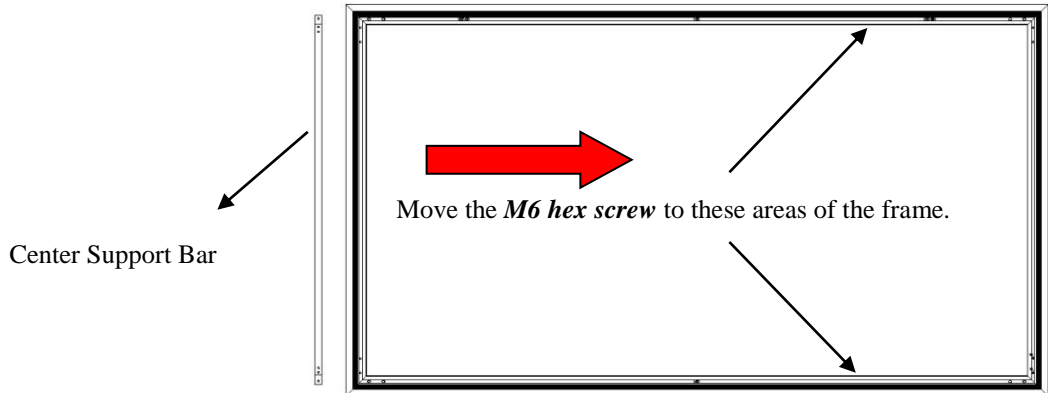

Center Support Bar

Move the *M6 hex screw* to these areas of the frame.

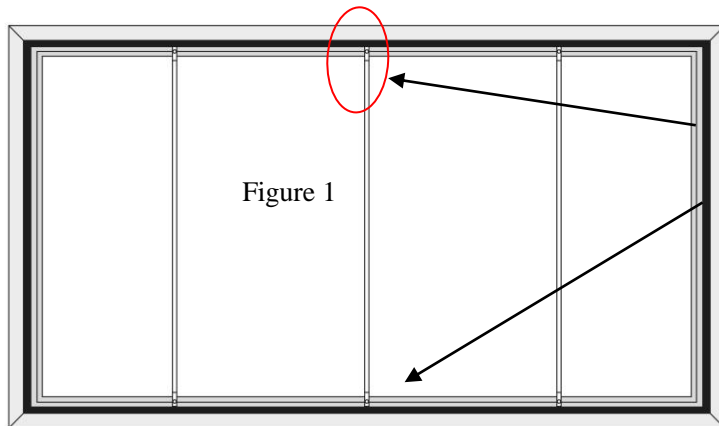
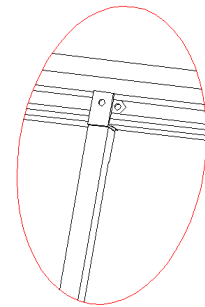

Figure 1

Align the M6 Screws with the two holes located on the Center Support Bar.



1. Position the *Corner support bars (M)* and *M6 Hex screws* in the areas of the frame as shown below in fig 2.
2. Align the holes on each end of the corner support bars with the M6 hex screws located on the vertical and horizontal frame sections. Then fasten with the *M6x12 screws*.

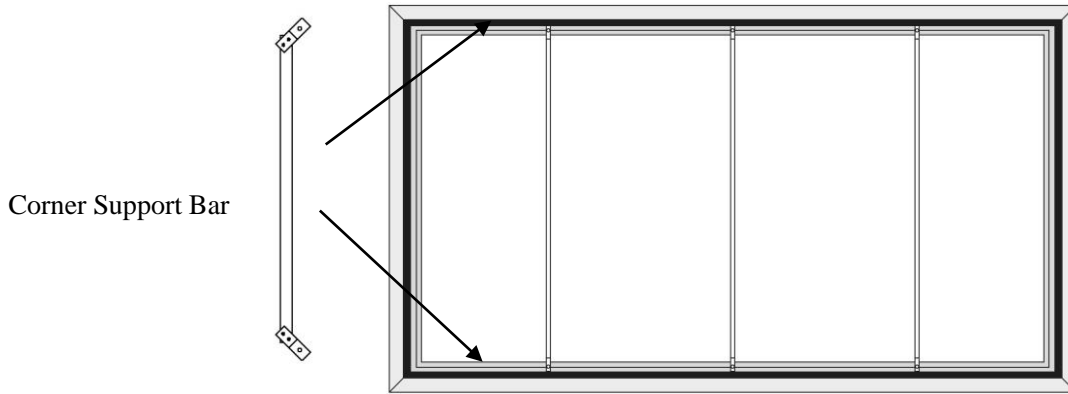
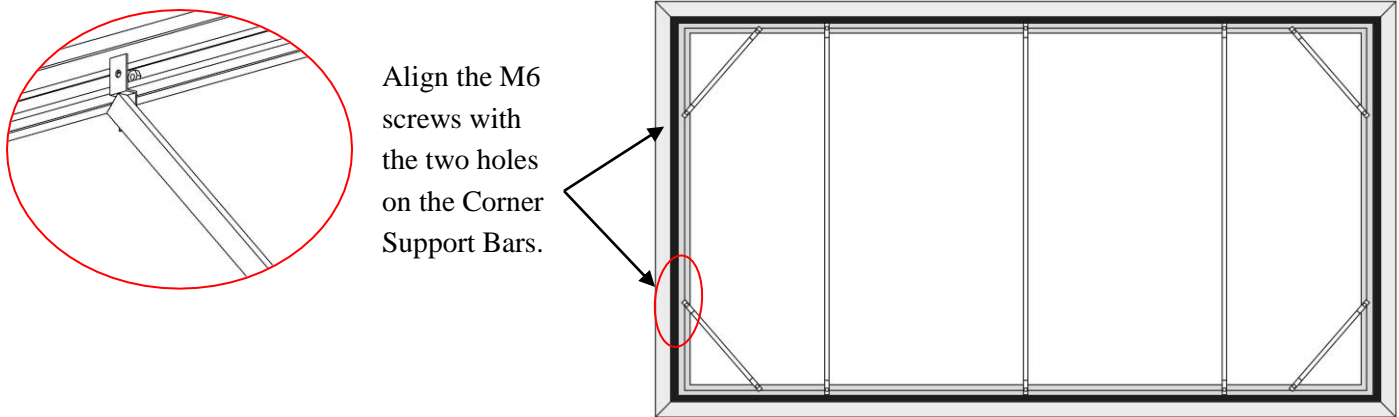

Figure 2



Notice to Installer:

Please use the following installation instructions to obtain superior optical performance from the CineGrey 3D® Angular Reflective ALR (Ambient Light Rejecting) Screen.

Make sure to follow these instructions in order for the CineGrey 3D® to perform correctly.

- Angular-Reflective material is not compatible with ultra/short-throw projectors
- Minimum lens throw ratio 1.5x image width
- Ambient light must not come from the same direction as the projector

Since angular-reflective means that the projected image will reflect at the mirror-opposite angle, it is important to position the projector so that the viewer will get the best possible image.

Step 1: Establish the general “eye level” of the viewers

Step 2: Set the appropriate projection level

Step 3: Adjust the screen height level and projection angle
Input Angle (A) = Output Angle (B) aligns with the viewer’s angle

Correct Installation Examples

Projector Ceiling Installation: Make sure the projector (*light in*) is angled (A) to reflect (B) at the mirror-opposite angle (*light out*) to align with the viewer's eye level.

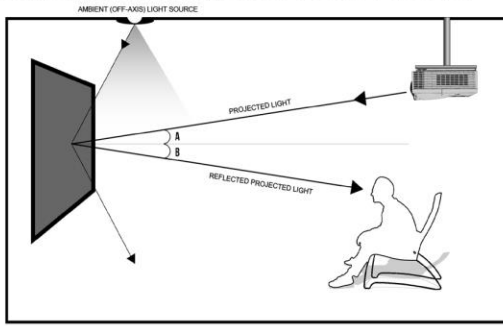

PROJECTOR CEILING INSTALLATION

Projector Table Top: Make sure the projector (*light in*) is angled (A) to reflect (B) at the mirror-opposite angle (*light out*) to align with the viewer's eye level.

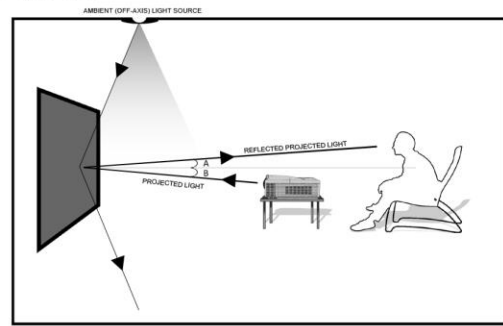

PROJECTOR TABLE TOP INSTALLATION

Incorrect Installation Examples

Ceiling Mounted Short-throw Projector

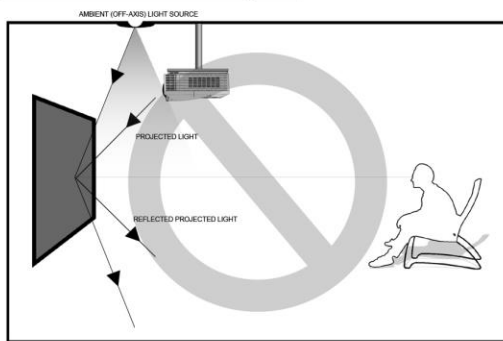

CLOSE UP CEILING PROJECTOR ILLUSTRATION (NOT COMPATIBLE)

Tabletop Ultra-Short throw Projector

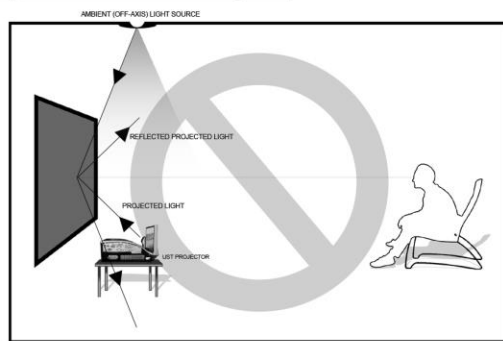

ULTRA SHORT THROW PROJECTOR ILLUSTRATION (NOT COMPATIBLE)

Note: Improper installation will result in light loss and produce a dark image. This is due to the projector's light reflecting in the wrong direction.

Images are not up to scale and are for illustration purposes only.

Edge trim Installation

Included is an ultra-thin black edge trim that provides an elegant bezel finish

Edge trim x 6 PCS

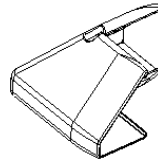

Plastic corner sleeve x4pcs



Black tape x1pcs

1. Place the assembled frame on a flat and clean surface. The projection screen surface should be facing up.
 - a. As an option, Black Tape is supplied to cover any possible gaps between the pieces of the bezel trim. Align the tape with the edge of the screen, as shown in Figure 1. Once properly aligned, apply the black tape to the center of the top and bottom of the screen material.

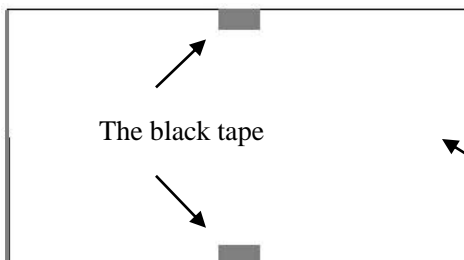
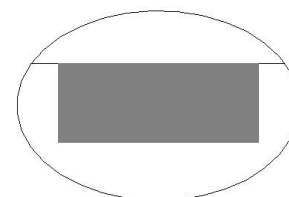

Figure 1

Screen Material



The black tape

2. Without removing the adhesive tape, place all the trim pieces along the edge of screen material. Adjust the trim so that the top and bottom trim pieces are touching and show no gaps in the center. (Note: The Elite logo should be positioned on the bottom right). Refer to Figure 2 below for a visual reference.

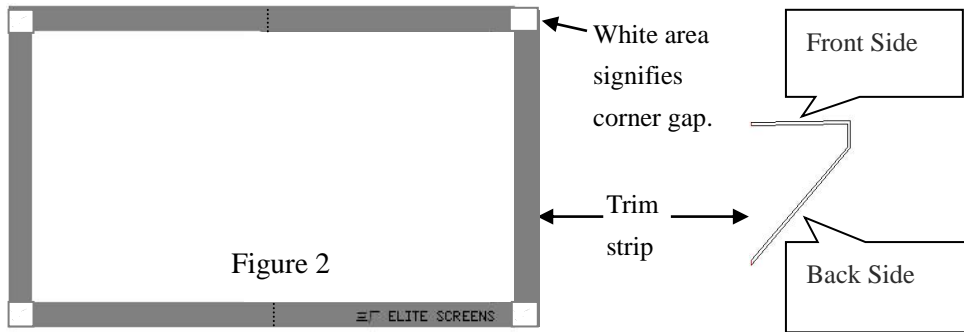

TIP:
Align the trim starting from the center to reduce gapping. Any gaps left at the corners will be covered by the corner sleeves.

NOTE: Make sure the bottom edge trim with the Elite Screens logo is installed on the correct side. The back of the material should be labeled with a DOWN sticker to indicate the material is facing in the down position. The Elite Screens logo should be installed on the DOWN side

3. After properly aligning all trim pieces, carefully remove trim piece A (see Figure 3 below). Remove the inside backing of the tape and place the trim piece in its original position on the frame. Repeat this step for the remaining trim pieces in the following order: B-C-D-E-F.

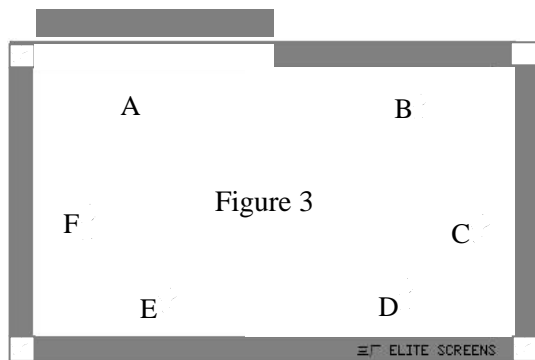

The front side of the frame with trim pieces attached.



4. After the bezel trim has been installed, place a *corner sleeve (N)* on all four corners. Begin by aligning and adjusting the corner sleeve through the front of the screen. Make sure the corner sleeve completely wraps the edge of the bezel trim. This should cover any corner gaps.

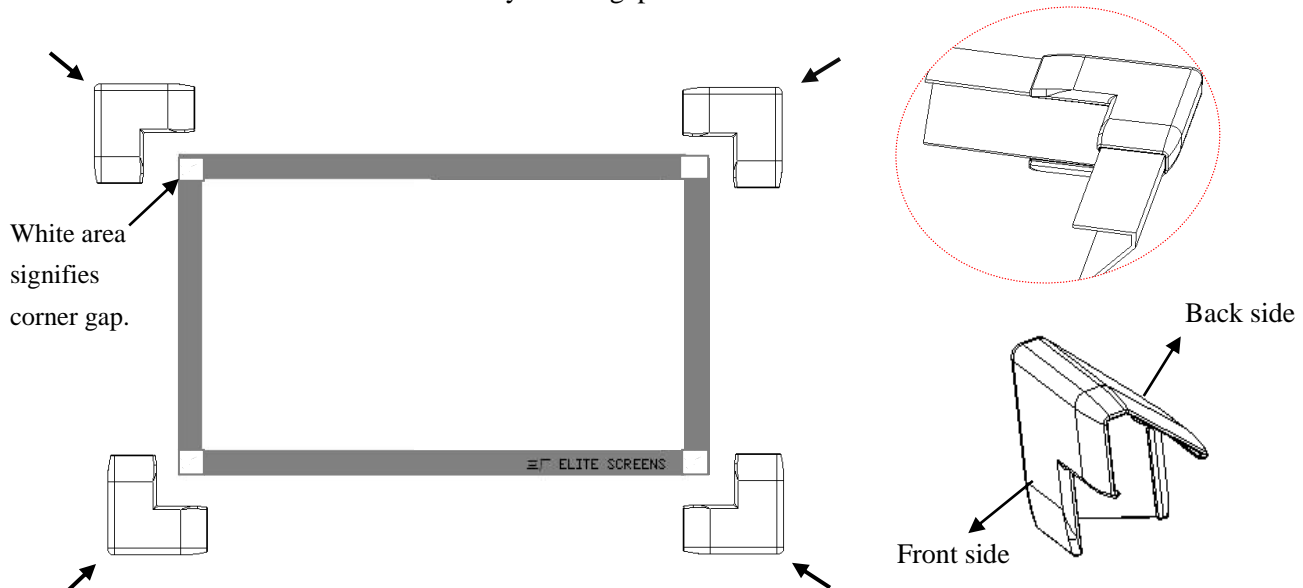

Once all corner sleeves have been snapped into each corner of the frame, it is ready to be installed.

Diagonal Size Note:

The Diagonal Size of the 100" & 120" models before and after installing the edge trim strip.

101" comparison

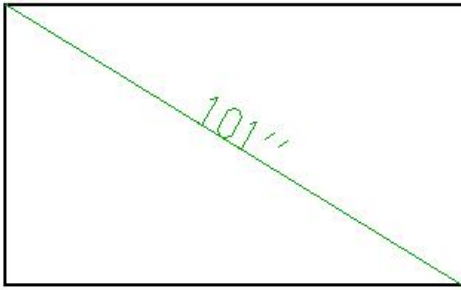

Before installing the trim strip

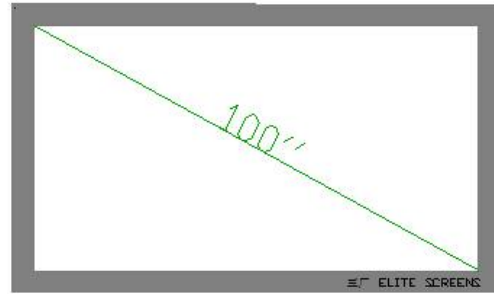

After installing the trim strip

120" comparison

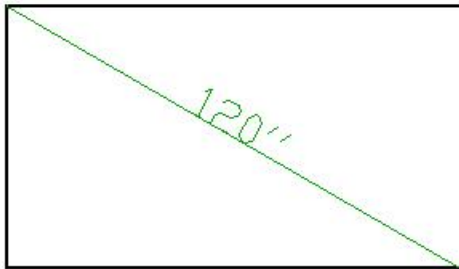

Before installing the trim strip

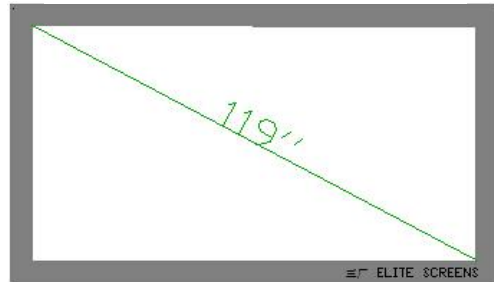

After installing the trim strip

Installation

Locate your desired installation location with a stud finder (recommended) and mark the drill-hole area of where the screen is to be installed.

1. Drill a hole with the proper bit size according to the wood screws included.
2. Line up the wall brackets with the drilled holes on the installation location and screw them in using a Phillips screwdriver.
3. Position the frame screen onto the **wall brackets (F)** as shown in **below**.
4. The design of the wall brackets allows the frame to slide over them through its sides. This is an important feature of the installation design as it allows your screen to be properly centered.

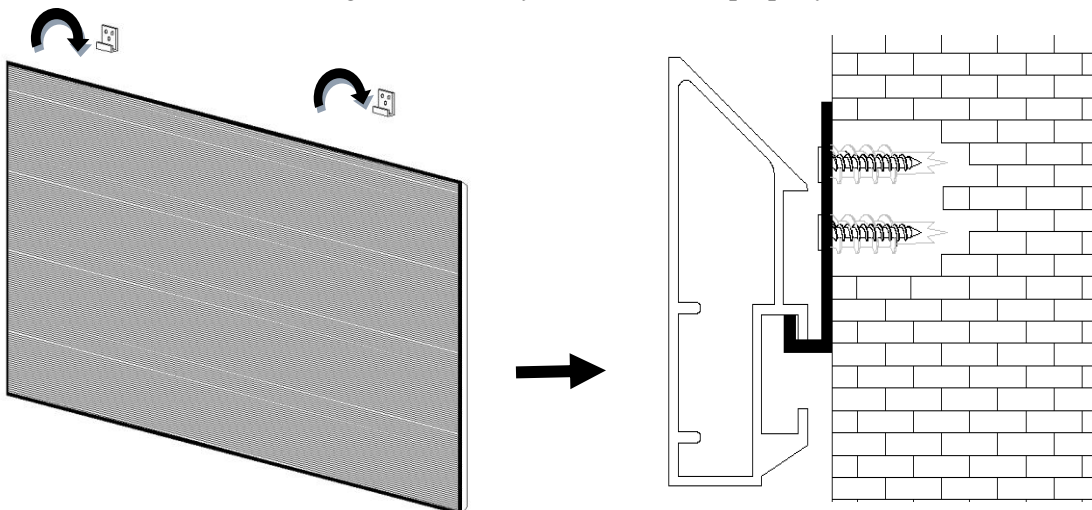

For a local Elite Screens contact or Technical Support, please visit

www.elitescreens.eu