







# Pop Up Gazebo Instruction Manual

## Parts List

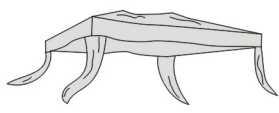
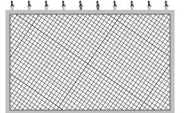
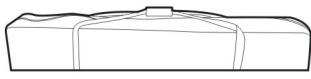
<b>A</b>	<b>B</b>	<b>C</b>	<b>D</b>
			
Gazebo Frame x1	Small Canopy x1	Big Canopy x1	Mosquito Netting x4

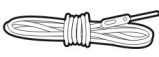
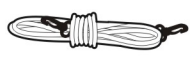
## Hardware Pack

				
Tent bag x1	sandbag x4	Guy rope x4	netting rope x4	Peg x8

**1**

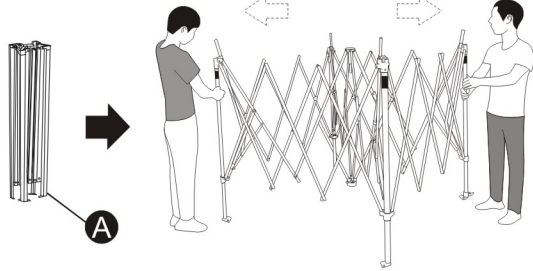

2 people stand in sides to expand the frame slowly until it is 50% open.

**2**

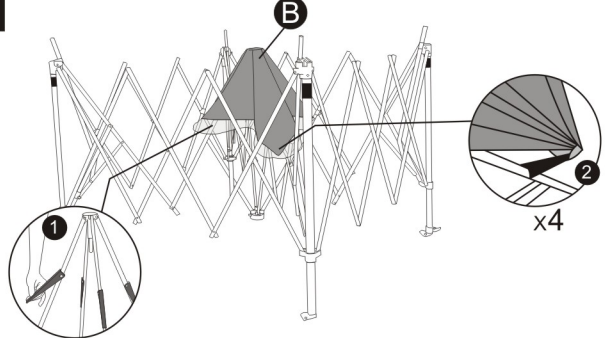

Cover the small canopy at the top of frame and insert 4 connectors into all sides of small canopy.

**3**

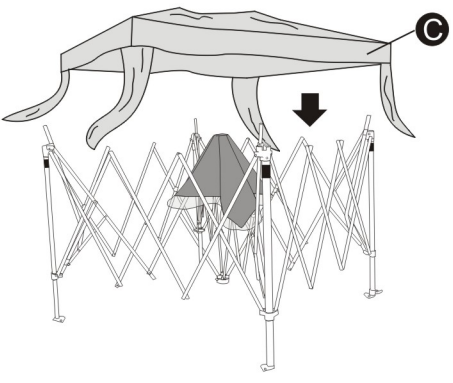

Install the big canopy over the top of frame.

**4**

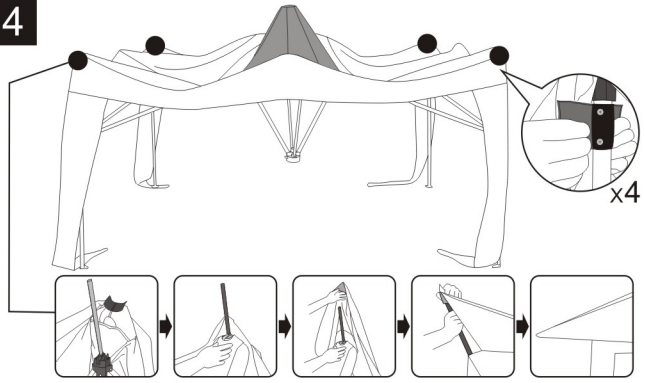

Attach velcro loop of 4 corners firmly. Insert 4 spreader bars into all sides of big canopy.

**5**

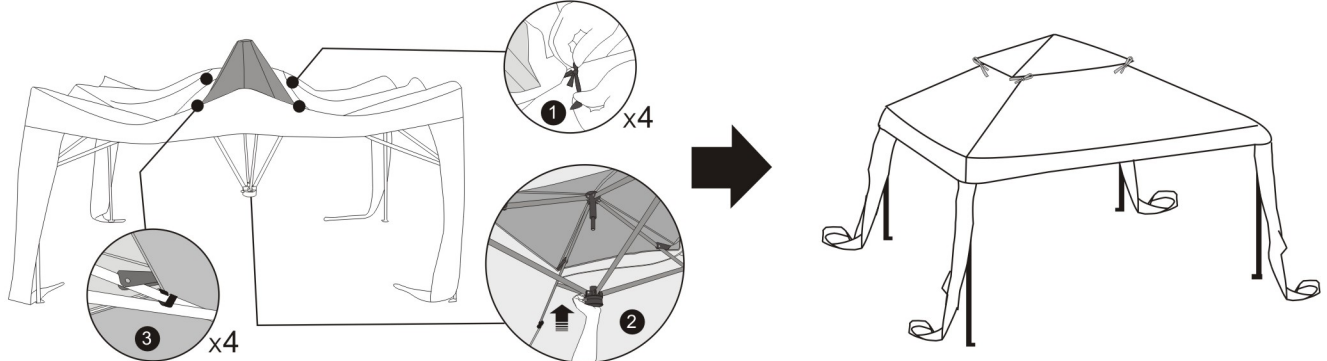

① Tie the four corners of small canopy. ② Push up the support rod until you hear "CLICK". ③ Secure the small canopy with velcro attachment on 4 corners of frame.

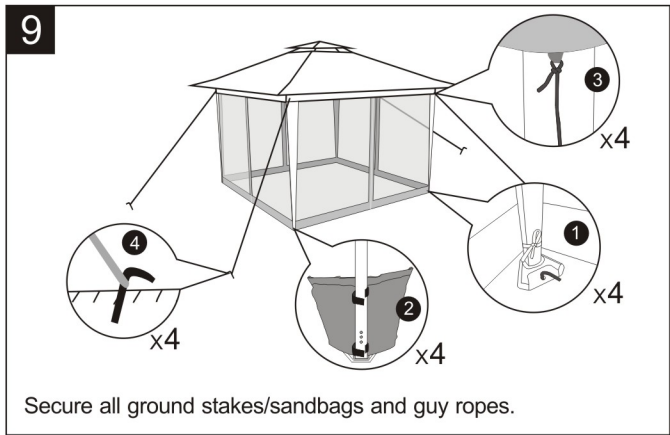
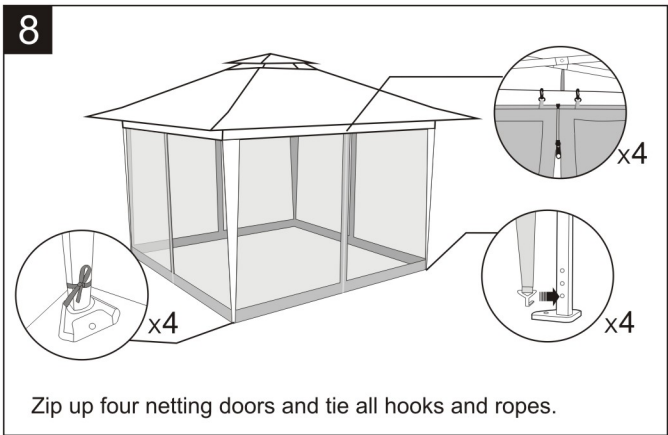
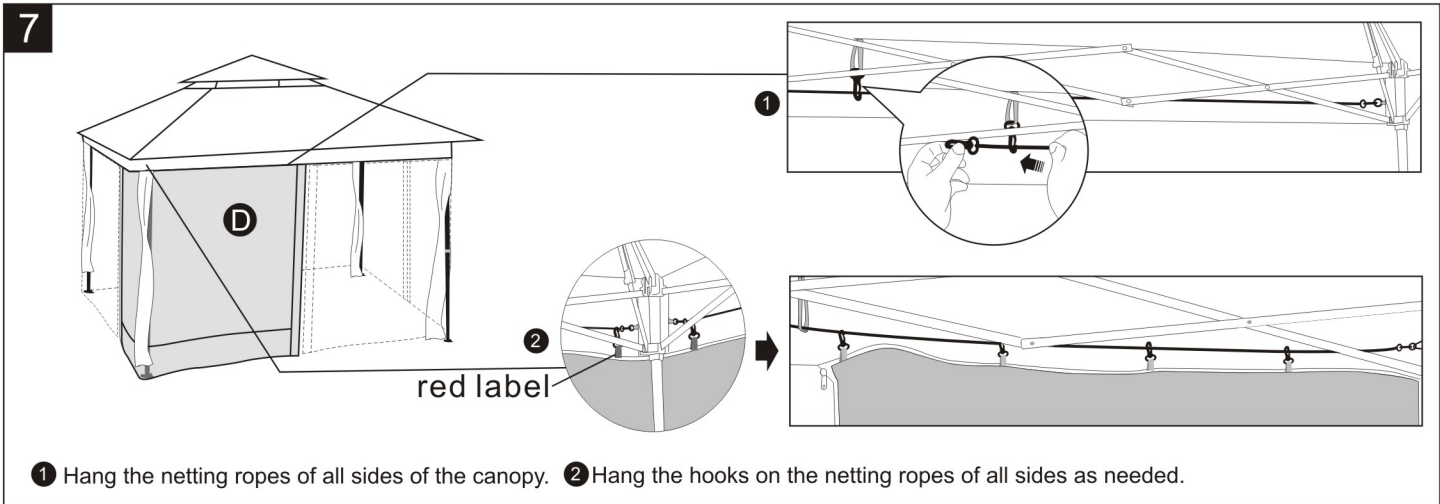
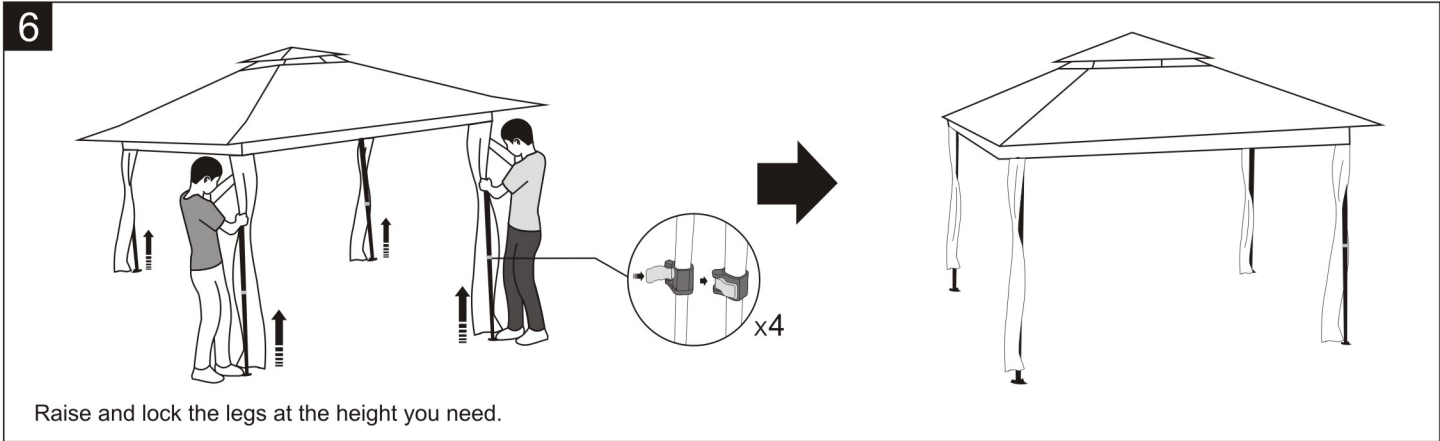

**Safety Information:**

Two people are required for this assembly.  
 Some parts may contain sharp edges. Wear protective gloves.  
 When assembling and using this product, basic safety precautions should always be followed to reduce the risk of personal injury and damage to equipment. Please read all instructions before assembly and usage.

**CAUTION:**

Do not climb on top of the gazebo. Falling off the gazebo can result in serious injury.  
 NOTICE: For outdoor use.

**WARNING:**

DO NOT LEAVE THE GAZEBO WHERE IS A RISK OF HIGH WIND, AS POSSIBLE DAMAGE WILL OCCUR TO THE STRUCTURE.  
 Keep all flame and heat sources away from this gazebo fabric.  
 Lowered the adjustable poles before the wind storm hit!

Manufacturer: Swiftech Company Ltd.  
 Dongcheng Industrial Zone, Xiping Road, Minzhong Town, Zhongshan City, Guangdong Province, China

MADE IN CHINA.