

230V  
1PH  
60HZ

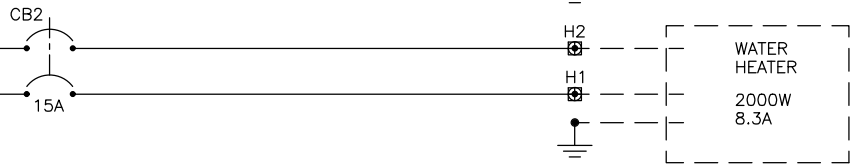

C  
P  
0

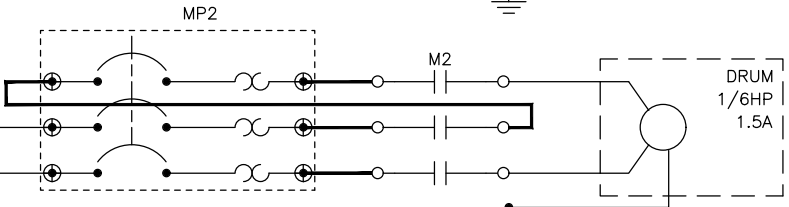
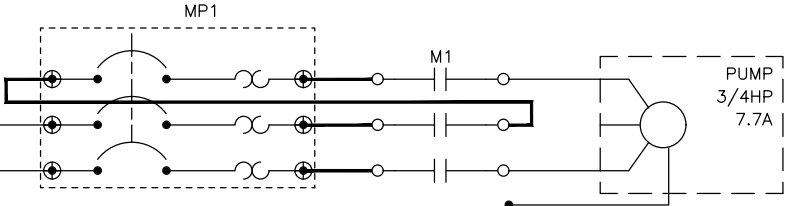
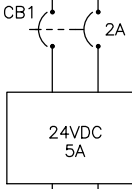
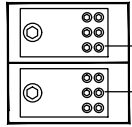
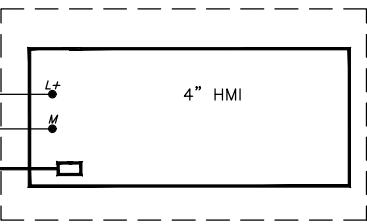
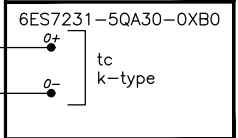
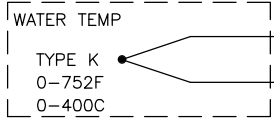
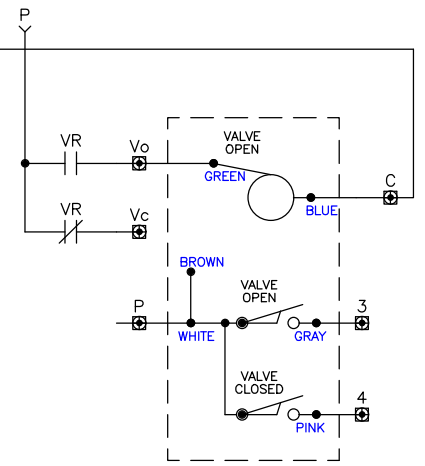
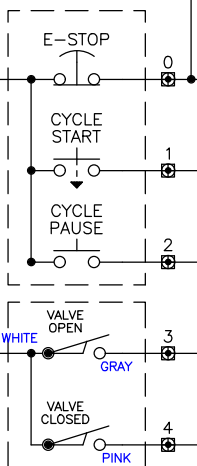
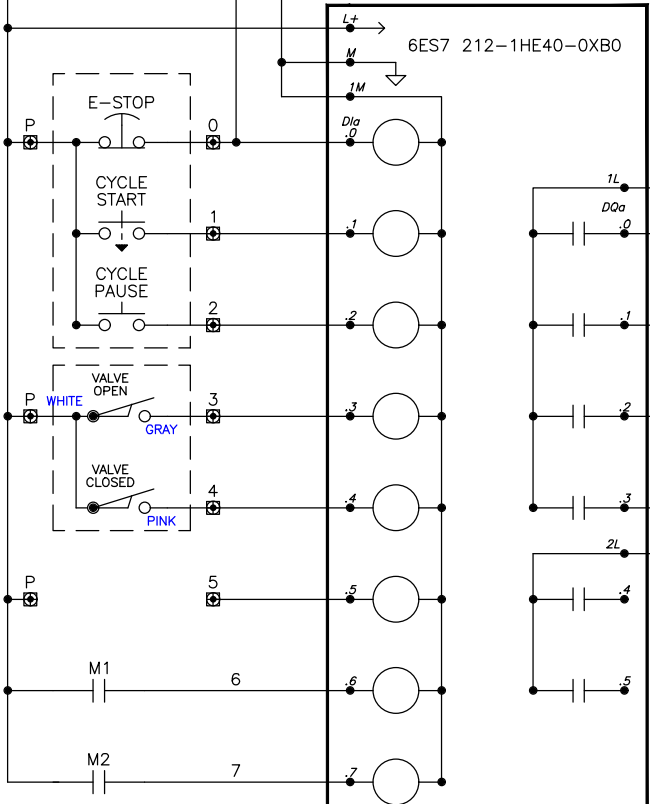

EXTERNAL FROM THIS PANEL

**Motor & Control solutions**

STATE MOTOR & CONTROL  
1977 CONGRESSIONAL DR.  
ST. LOUIS, MO 63146  
314-569-2140  
WWW.MOTORSANDCONTROL.COM

CUST	RAYZIST	SHT	1 OF 1
DESC	1650 WASHER	DWG	R-1152187_R2
DATE	3-27-23		