



# singing machine®

creating Joy through music

---

## iSM1060BT

INSTRUCTION MANUAL

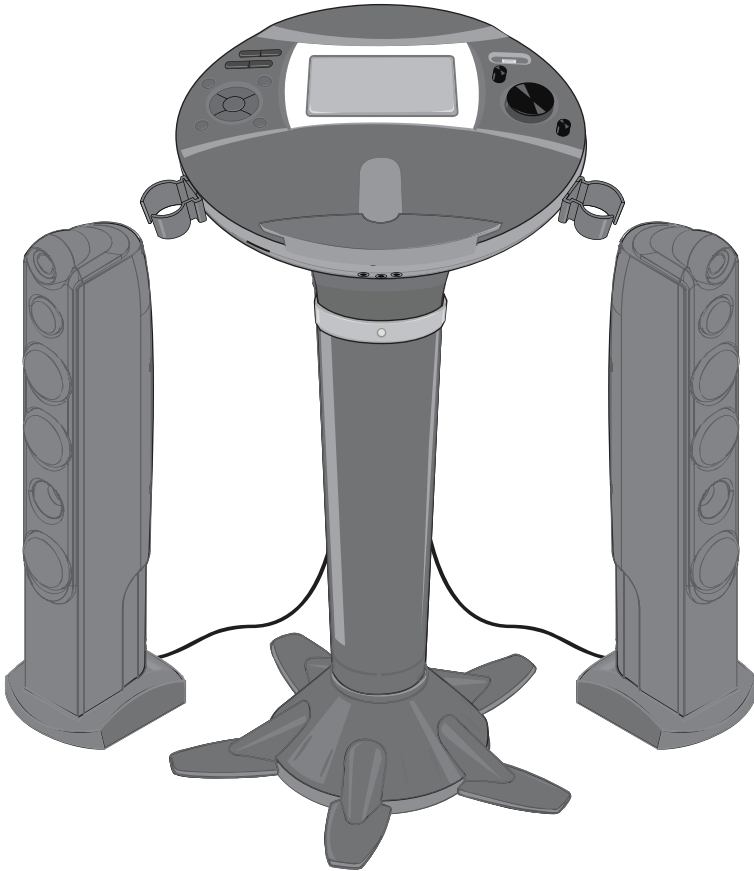

[www.singingsmachine.com](http://www.singingsmachine.com)

The Singing Machine® is a registered trademark of The Singing Machine Co., Inc.

# Warnings



**DANGEROUS VOLTAGE:** The lightning flash with arrowhead symbol within an equilateral triangle is intended to alert the user to the presence of uninsulated dangerous voltage within the product's enclosure that may be of sufficient magnitude to constitute a risk of electric shock to persons.



**ATTENTION:** The exclamation point within an equilateral triangle is intended to alert the user to the presence of important operating and maintenance (servicing) instructions in the literature accompanying this product.

**DRIPPING WARNING:** This product shall not be exposed to dripping or splashing, and no objects filled with liquids, such as vases, shall be placed on the product.

**VENTILATION WARNING:** The normal ventilation of the product shall not be impeded for intended use.

**SAFETY VERIFICATION:** This device is made and tested to meet safety standards of the FCC, requirements and compliance with safety performance of the U.S. Department of Health and Human Services and also with FDA Radiation Performance Standards 21 CFR Subchapter.

**CAUTION:** TO PREVENT ELECTRIC SHOCK, MATCH WIDE BLADE OF PLUG TO WIDE SLOT AND FULLY INSERT.

**WARNING:** TO PREVENT FIRE OR SHOCK HAZARD, DO NOT EXPOSE THIS UNIT TO RAIN OR MOISTURE.

**FCC WARNING:** This equipment may generate or use radio frequency energy. Changes or modifications to this equipment may cause harmful interference unless the modifications are expressly approved in the instruction manual. The user could lose the authority to operate this equipment if an unauthorized change or modification is made.

This device complies with part 15 of the FCC Rules. Operation is subject to the following two conditions: (1) This device must not cause harmful interference, and (2) this device must accept any interference received, including interference that may cause undesired operation.

**NOTE:** This equipment has been tested and found to comply with the limits for a Class B digital device, pursuant to part 15 of the FCC Rules. These limits are designed to provide reasonable protection against harmful interference in a residential installation. This equipment generates, uses and can radiate radio frequency energy and, if not installed and used in accordance with the instructions, may cause harmful interference to radio communications. However, there is no guarantee that interference will not occur in a particular installation. If this equipment does cause harmful interference to radio or television reception, which can be determined by turning the equipment off and on, the user is encouraged to try to correct the interference by one or more of the following measures:

- Reorient or relocate the receiving antenna.
- Increase the separation between the equipment and receiver.
- Connect the equipment into an outlet on a circuit different from that to which the receiver is connected.
- Consult the dealer or an experienced radio/TV technician for help.
- The rating information is located at the bottom of the unit.

#### INDUSTRY CANADA NOTICE:

This device complies with Industry Canada license-exempt RSS standard(s). Operation is subject to the following two conditions:

1. This device may not cause interference, and
2. This device must accept any interference, including interference that may cause undesired operation of the device.

CAN ICES-3(B)/NMB-3(B)

## Important Safety Information

1. Read these Instructions.
2. Keep these Instructions.
3. Heed all Warnings.
4. Follow all Instructions.
5. Do not use this apparatus near water.
6. Clean only with a dry cloth.
7. Do not block any of the ventilation openings. Install in accordance with the Manufacturer's instructions.
8. Do not install near any heat sources such as radiators, heat registers, stoves, or other apparatus (including amplifiers) that produce heat.
9. Do not defeat the safety purpose of the polarized or grounding-type plug. A polarized plug has two blades with one wider than the other. A grounding type plug has two blades and a third grounding prong. The wide blade or the third prong are provided for your safety. When the provided plug does not fit into your outlet, consult an electrician for replacement of the obsolete outlet.
10. Protect the power cord from being walked on or pinched particularly at plugs, convenience receptacles, and the point where they exit from the apparatus.
11. Only use attachments/accessories specified by the manufacturer.
12. Use only with a cart, stand, tripod, bracket, or table specified by the manufacturer, or sold with the apparatus. When a cart is used,

use caution when moving the cart/apparatus combination to avoid injury from tip-over.

13. Unplug this apparatus during lightning storms or when unused for long periods of time.
14. Refer all servicing to qualified service personnel. Servicing is required when the apparatus has been damaged in any way, such as power-supply cord or plug is damaged, liquid has been spilled or objects have fallen into the apparatus, the apparatus has been exposed to rain or moisture, does not operate normally, or has been dropped.
15. **WARNING:** To reduce the risk of fire or electric shock, do not expose this apparatus to rain or moisture. Do not place objects filled with water, such as a vase, on the apparatus.
16. The AC mains plug is used as the power disconnect device and it should remain readily accessible and operable during intended use. In order to completely disconnect the apparatus from power, the mains plug should be completely removed from the AC outlet socket.
17. **CAUTION:** To reduce the risk of fire or explosion, do not expose batteries to excessive heat such as sunshine, fire or other heat sources.

PORTABLE CART WARNING  
(symbol provided by RETAC)



# Included

Please make sure the following items are included.

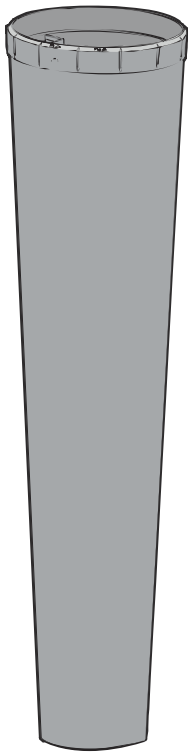

Pedestal

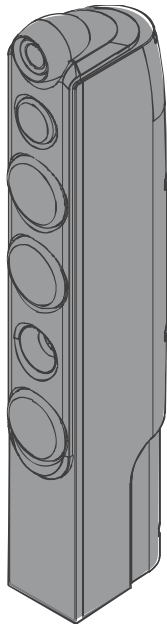

Tower Speaker x 2

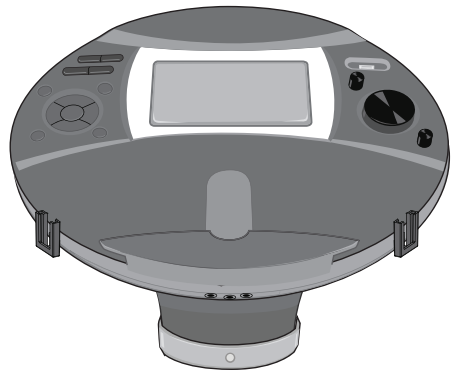

iSM1060BT Base



Wired Microphone x 2

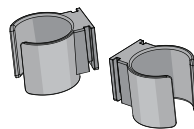

Detachable Mic Holder x 2



Singing Machine Flash Drive

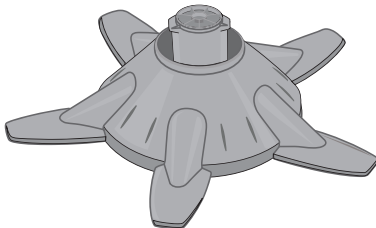

Stand

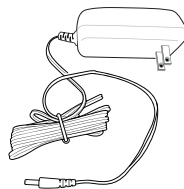

AC Adaptor

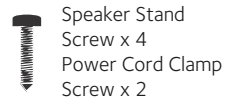

Speaker Stand Screw x 4  
Power Cord Clamp Screw x 2



Pedestal Screw x 2

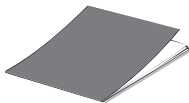

Manual

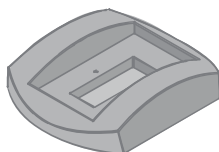

Speaker Stand x 2



Power Cord Clamp x 2

# Installation

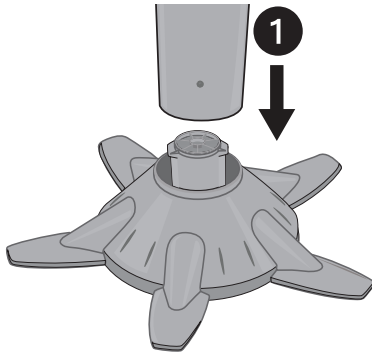

- 1 Insert the pedestal into the stand ① and then gently rotate clockwise ② until tight, making sure the screw hole in the Pedestal aligns with the screw hole on the stand.

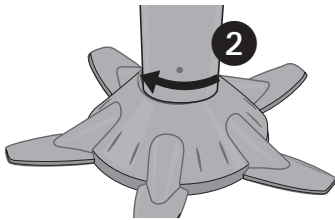

- 2 Insert and tighten one of the silver pedestal screws to secure the Pedestal to the stand (as shown).

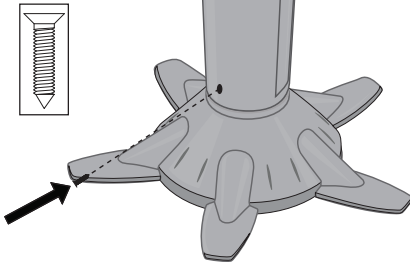

- 3 Install the power cord clips into areas ① and ② and secure them using the two black clamp screws. Then align the power cord securely under the clamps.

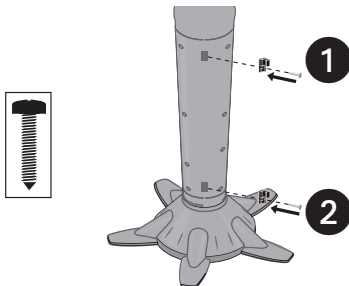

# Installation

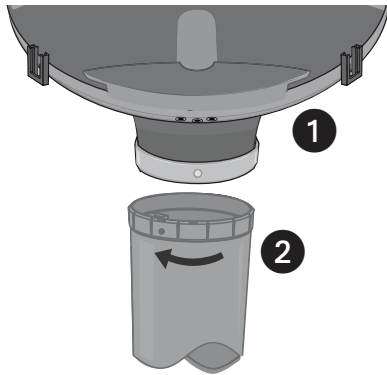

- 4 Insert the base into the pedestal **1** and then gently rotate clockwise **2** until the screw hole on the base aligns with the screw hole on the pedestal.

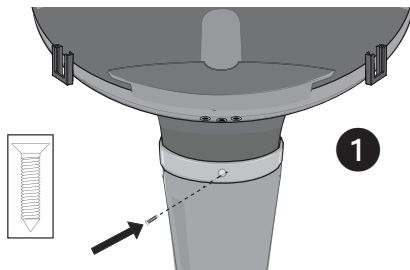

- 5 Insert and tighten the remaining silver pedestal screw to secure the base to the pedestal.

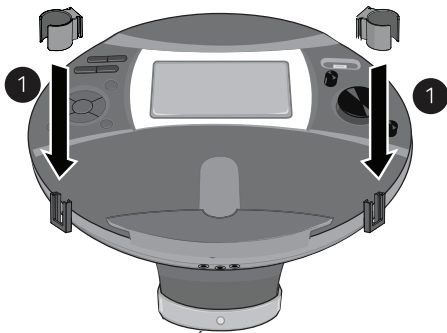

- 6 Insert the detachable mic holders **1** into the mic holder slots as illustrated.

# Installation

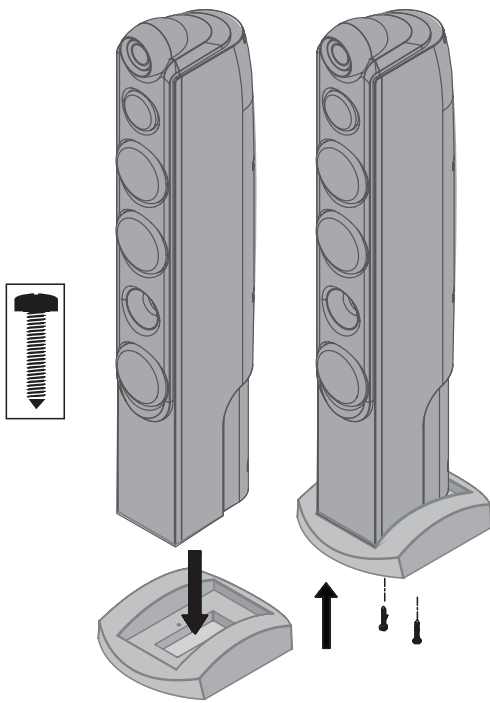

- 7 Place the tower speaker on to the speaker stand aligning the screw holes on both the speaker and stand, then insert and tighten the black screws through the bottom of the base.

# Location of Controls (Top/Front)

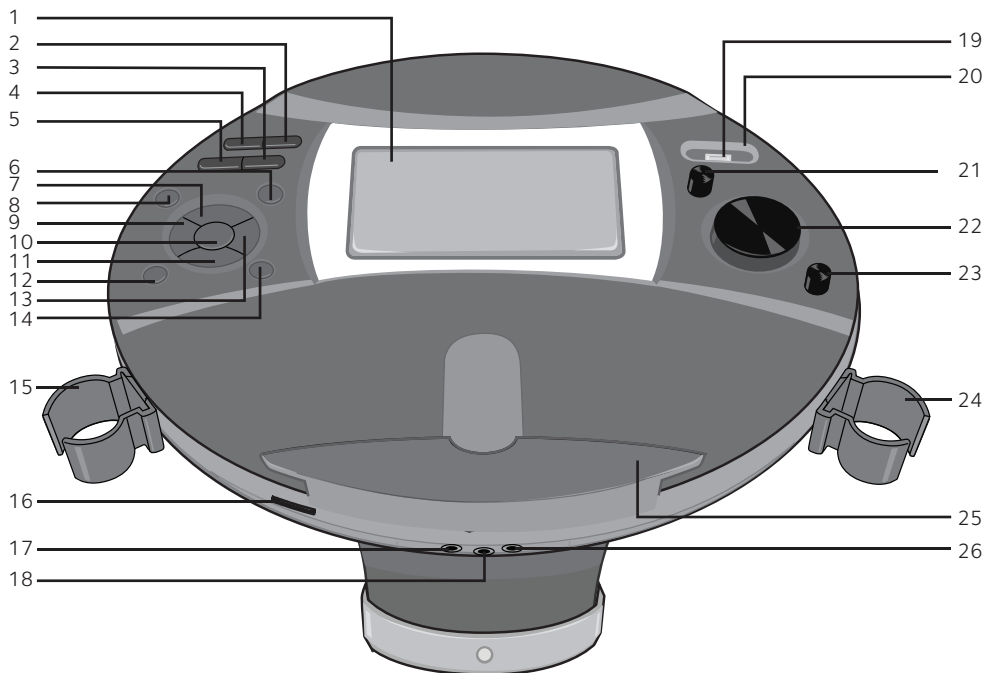

- |                               |                                    |
|-------------------------------|------------------------------------|
| 1. TFT LCD Color Screen       | 14. RECORD ● Button                |
| 2. FUNCTION Button            | 15. MIC 1 Holder                   |
| 3. BLUETOOTH Pairing Button   | 16. SD Card Slot (for Record only) |
| 4. ON/OFF Button              | 17. MIC 1 Jack                     |
| 5. VOCAL Button               | 18. Headphone Jack                 |
| 6. MENU Button                | 19. SMC USB Slot                   |
| 7. Navigation UP ▲ Button     | 20. ON/OFF Indicator               |
| 8. ECHO + Button              | 21. MIC 1 VOLUME Control           |
| 9. Navigation LEFT ◀ Button   | 22. MASTER VOLUME Control          |
| 10. ENTER/▶    Button         | 23. MIC 2 VOLUME Control           |
| 11. Navigation DOWN ▼ Button  | 24. MIC 2 Holder                   |
| 12. ECHO - Button             | 25. Cradle                         |
| 13. Navigation RIGHT ▶ Button | 26. MIC 2 Jack                     |

# Location of Controls (Rear)

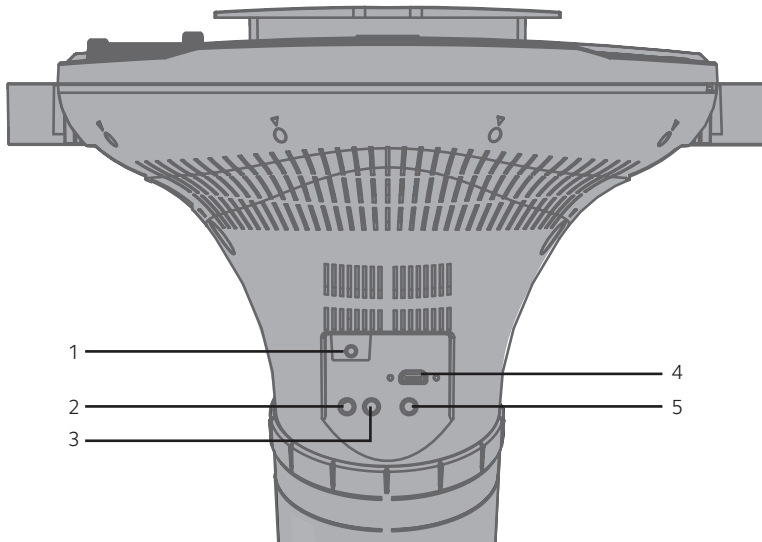

- 1. DC Jack
- 2. Right Tower Speaker Jack
- 3. Left Tower Speaker Jack
- 4. HDMI Jack
- 5. LINE IN Jack

# Location of Controls (Playback Display)

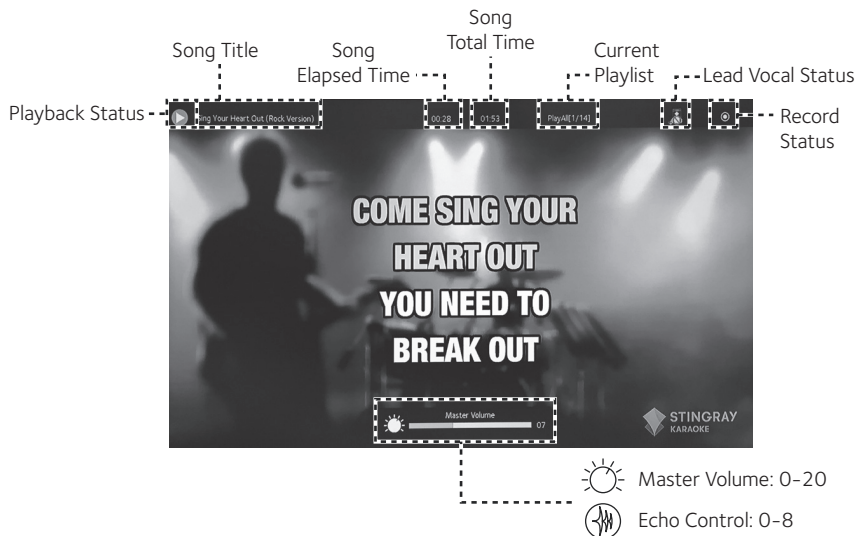



# Connection

## Connecting the Microphones and Headphones



### Microphones:

Connect a microphone into Mic jack 1 **1** as well as Mic jack 2 **2** (when desired).

**Note:** Do not drop or tap the Mic as damage to the Mic or speakers may occur. Do not twirl the microphone by cord as it will cause damage to the encased wiring.

### Headphones:

For private listening, use headphones (not included). Install headphones into the headphone jack **3**.

**Note:** The headphones must be disconnected for the speakers to produce sound.

---

## Connecting the Tower Speakers

- 1** To protect the speakers, make sure the iSM1060BT is off and the **MASTER VOLUME** and the **MIC 1** and **2 VOLUME** controls are set to minimum.
- 2** Connect the Right and Left Tower Speakers to the jacks on back of the unit as illustrated.
- 3** Turn the power on and slowly raise the **MASTER VOLUME** and the **MIC 1** and **2 VOLUME** controls to a comfortable level.

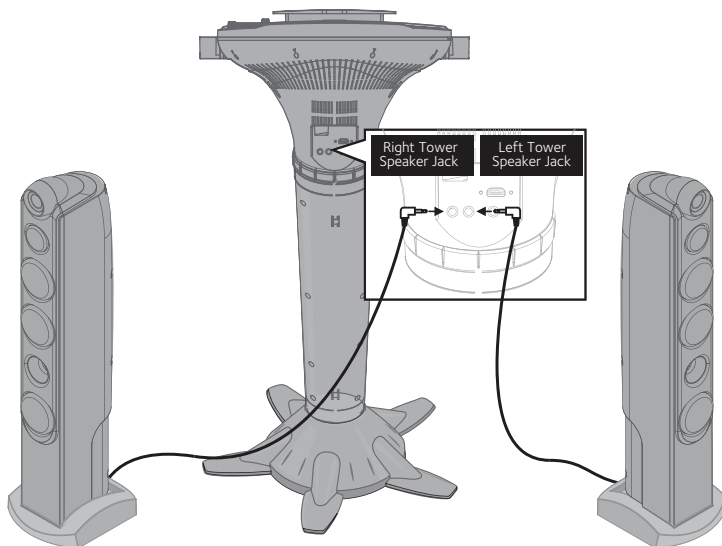

# Connection

## Connecting the Unit to a TV

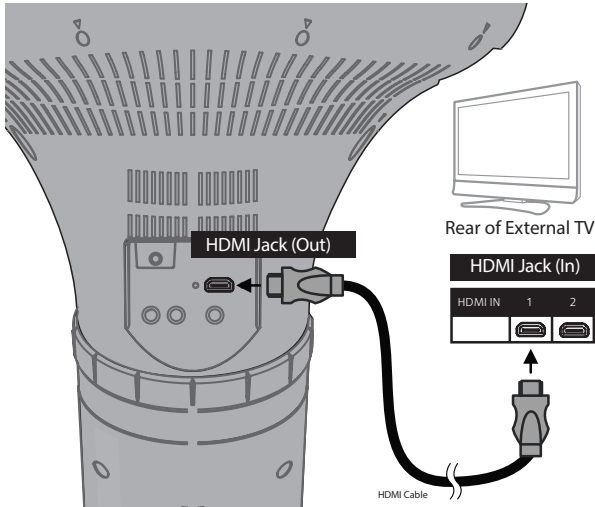

The video and lyrics will be displayed on the built-in screen. You may also want to connect a TV to display a larger image and additional sound; follow the steps below:

Plug the HDMI cable (not included) into the HDMI Jack on the back of the unit. Plug the other end of the HDMI cable into the HDMI input on your TV.

### Notes:

- This unit can be used with or without a TV.
- Also refer to the TV's or external unit's User Guide.

---

## Connecting to AC Power

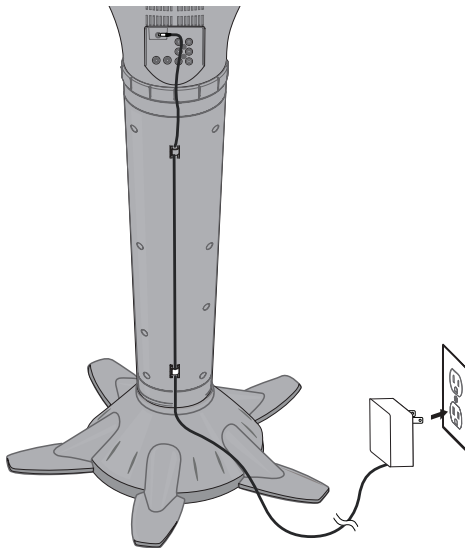

**1** Insert the AC adaptor into a conveniently located AC outlet having 120V AC, 60Hz .

**2** Secure the power cord into the Power Clamps previously installed.

### Notes:

- Make all connections prior to plugging the AC adaptor into a power outlet.
- The AC adaptor has a polarized plug that fits into the AC outlet only one way. If the plug does not fit properly, turn it over and try again. Do not force and do not file or cut the wide blade.

# Singing Machine USB Flash Drive



Included with the system is a **Singing Machine USB Flash Drive** which is used for storing Karaoke songs as well as recordings from this unit.

There are two songs included on the **Singing Machine USB Flash Drive** but you can access the Karaoke Store for many more songs. Just follow the Welcome Kit Instructions!

---

## Inserting the USB Flash Drive or an SD Card

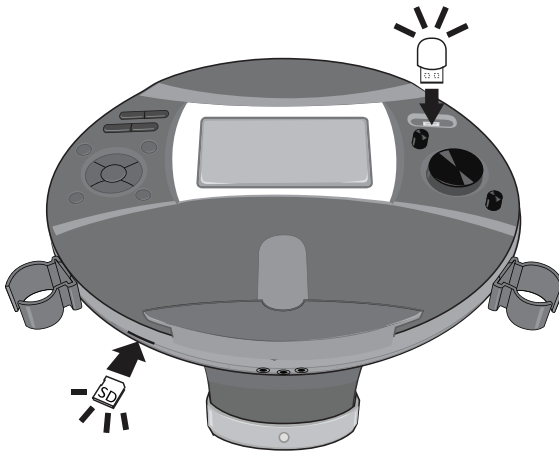

Before you insert the **Singing Machine USB Flash Drive**, make sure to remove it from its stand which will reveal the USB plug.

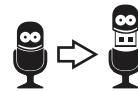

Insert it into the USB slot on the unit with the face towards the back of the unit. If you would like to have more memory capacity for the recording function, you can insert an SD Card with up to 32 GB (not included) to store the recording files as well.

**Note:** If both an SD Card and a USB Flash Drive are inserted, the unit will automatically record onto the SD card.

# Karaoke Store

## PC Installation

The Karaoke Store application can be installed on Microsoft Windows computers running Vista, Windows 7 and Windows 8 or higher. The Karaoke Store application requires connection to the Internet (a high-speed connection is recommended).

1 Insert the **Singing Machine USB Flash Drive** into a powered USB slot on your computer.

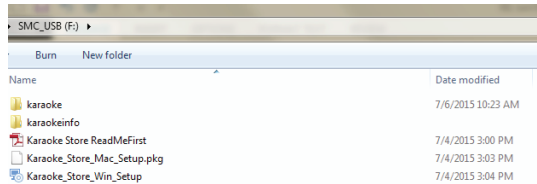

2 Double click the file named, "Karaoke\_Store\_Win\_Setup".

3 Follow the online instructions to install the software on your computer.



4 After installing, open your Program's folder and open the **Karaoke Store** folder.

5 Double click Karaoke Store App to open the software.

6 On this page you can now sign up and enter your code (located on your welcome kit) for 10 free downloads and then download them to your USB drive for playing on your new Singing Machine!

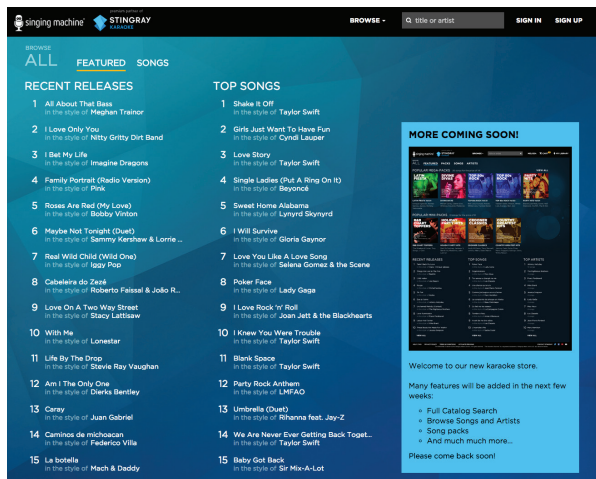

# Karaoke Store

## Mac Installation

The Karaoke Store application can be installed on Apple Macintosh computers running OS X 10.8 and higher. The Karaoke Store application requires connection to the Internet (a high-speed connection is recommended).

1 Insert the **Singing Machine USB Flash Drive** into a powered USB slot on your computer.

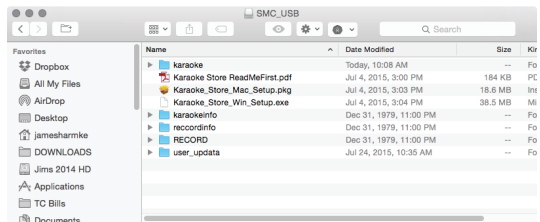

2 Double click the file named, "Karaoke\_Store\_Mac\_Setup.pkg".

3 Follow the online instructions to install the software on your computer.

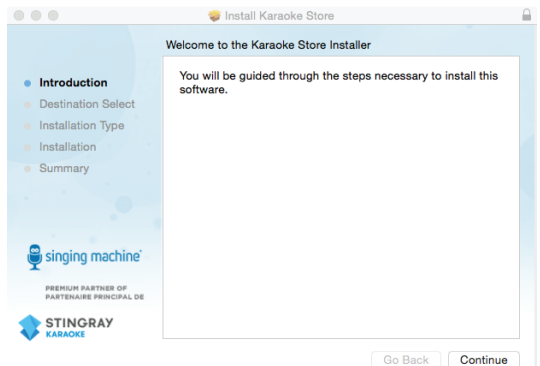

4 After installing, open your Application's folder and open the **Stingray Karaoke Store** folder.

5 Double click Karaoke Store to open the software.

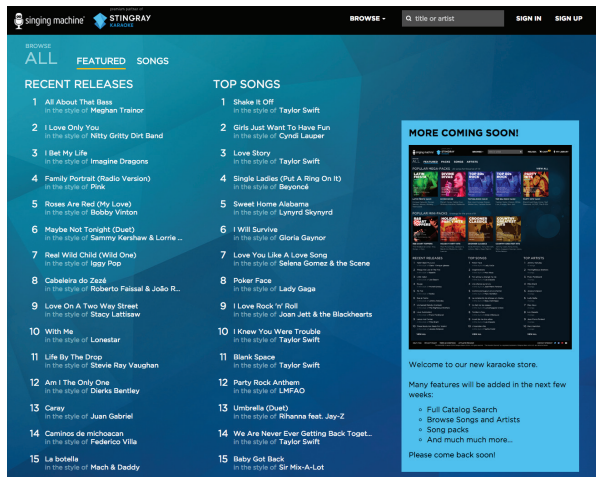

6 On this page you can now sign up and enter your code (located on your welcome kit) for 10 free downloads and then download them to your USB drive for playing on your new Singing Machine!

# Operation

## Playing Songs from the USB



- 1 Connect the unit as described previously. Press the **ON/OFF** button **1** to turn the unit on; the ON/OFF indicator will light blue.

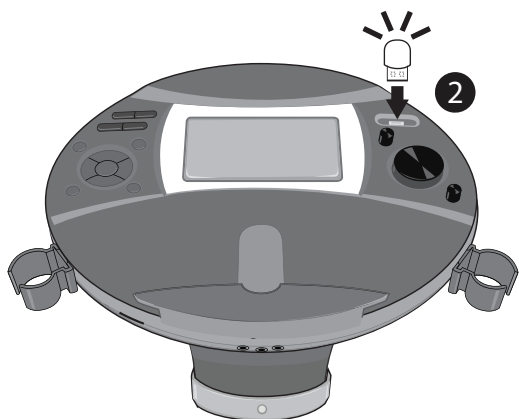

- 2 Remove the provided Singing Machine flash drive from its stand to reveal the USB plug. Insert it into the USB slot on the unit so it faces towards the back of the unit.

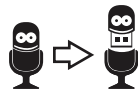

**Note:** The Singing Machine flash drive has an 8GB capacity (the actual capacity may vary slightly).



- 3 The USB mode will be selected by default; press the **ENTER** button to enter the USB mode.

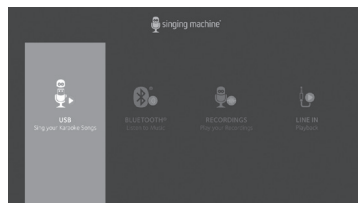

### Notes:

- The USB mode cannot be accessed until a flash drive is inserted.
- A loading icon will appear when the system is loading the songs.

# Operation

## Playing Songs from the USB (Continued)



- 4 Use the **Navigation** ▲ up and ▼ down buttons to navigate through the list of songs in which you have previously downloaded into your USB.

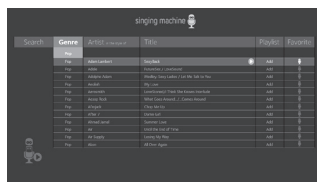

- 5 Press the **ENTER** ▶|| button to start the playback. The HD karaoke video will play on the screen. Press the **ENTER** ▶|| button during playback to pause the song. Press the **MENU** button to stop the playback and go back to the USB menu.

- 6 Adjust the volume to a comfortable level using the **MASTER VOLUME** control.

### Notes:

- If connected to a TV, there will be no display on the on the built-in monitor.
- If connected to a TV, control the volume with the TV's volume control.

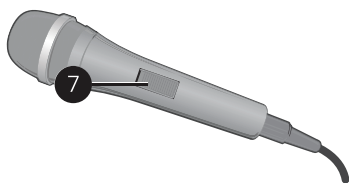

- 7 Connect the microphone(s) as shown on page 8. Slide the mic's **Power** switch to the ON position





- 8 Adjust the **MIC VOLUME 1** or **2** control as desired. Increasing this will increase the volume of the respective microphone.

- 9 Press **ECHO +/-** buttons to add an echo effect to your voice. The higher the number, the more echo effect.

# Operation



## Playing Songs from the USB (Continued)



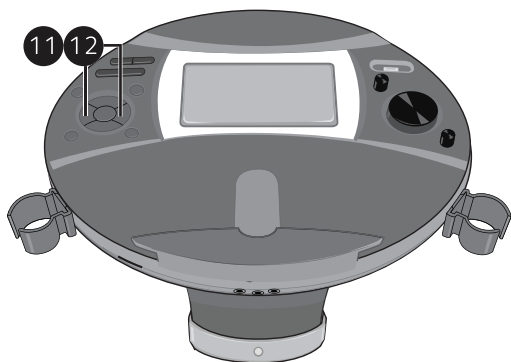

- 10 LEAD VOCAL:** To sing with the lead singer on the recording press the **VOCAL** button; “” will appear at the top right of the monitor). To listen to music only, press the **VOCAL** button again; “” will appear over the Lead Vocal Status icon.

**Note:** The song must be recorded with separate vocals in order to utilize the Lead Vocal function.



- 11 SKIP:** Advance or go back one track by pressing the **Navigation**  right or  left button.

- 12 TO ADVANCE ON THE TRACK:** During playback, press and hold the **Navigation**  Right or Left  button to move forward or backward. When you release the button, normal playback will resume.



# Operation

## Playing Songs from the USB (Continued)

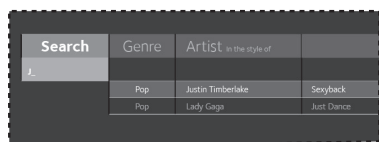
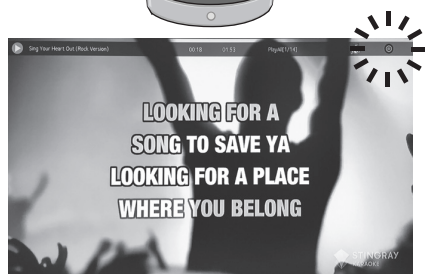
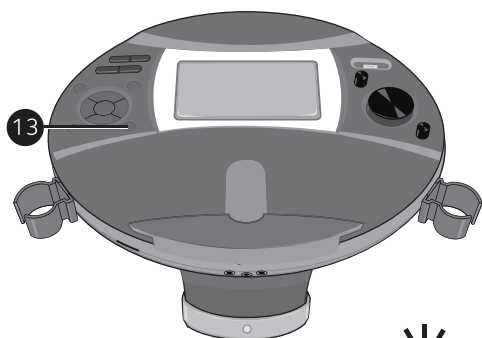

- 13 RECORDING YOUR SINGING:**  
To record your singing as well as the music, press the **RECORD** button; recording will begin and the record icon at the top right corner of the monitor which will display red. When done recording, press the **RECORD** button again; the Record icon will stop blinking red.

### Notes:

- If an SD card is installed, the recorded audio file will record on it. If no SD card is present, the recorded audio file will record onto the USB drive.
- The recorded audio file will be named starting with the Karaoke song title.
- See page 23 to play back your recorded files.

- 14 SEARCHING BY ARTIST OR TITLE:**  
While in the USB menu, select **Search** using the **Navigation** ◀ left and ▶ right buttons, then press the **ENTER** ►||| button. The alphabet will appear at the bottom of the screen. Select the desired starting letter using the **MASTER VOLUME** control, then press the **ENTER** ►||| button to select it. A list of songs that meet the criteria will appear. Use the **Navigation** ▲ up and ▼ down buttons to navigate through the list of songs then press the **ENTER** ►||| button to play it, or select the next letter the same way.

### Note:

- You can search up to six letters; after the sixth letter the search will reset.

# Operation

## Playing Songs from the USB (Continued)



**15 SEARCHING BY GENRE, ARTIST or TITLE:** To filter by Genre, Artist or Title, select the **Genre**, **Artist**, or **Title** using the **Navigation** ◀ left and ▶ right buttons, then press the **ENTER** ►||| button. The alphabet will appear at the bottom of the screen; select the desired starting letter using the **MASTER VOLUME** control, then press the **ENTER** ►||| button to select it. A list of songs that meet the criteria will appear. Use the **Navigation** ▲ up and ▼ down buttons to navigate through the list of songs then press the **ENTER** ►||| button to play it, or select the next letter the same way.

**Note:**

- You can search up to six letters. After the sixth letter the search will reset.

**16 CREATING THE PLAYLIST:** To create a personalized playlist, select a song using the **Navigation** ▲ up and ▼ down buttons, then scroll to the **Playlist** column (**Add**) using the **Navigation** ▶ right or ◀ left button. Press the **ENTER** ►||| button to confirm the operation; “Added” will appear. Repeat this step to add more songs.

**Notes:**

- The personalized Playlist will be kept even if the unit is turned on and off.
- You can always edit your Playlist after you create it by selecting a song that was added and pressing the **ENTER** ►||| button again; “Added” will change to “Add”.

# Operation

## Playing Songs from the USB (Continued)

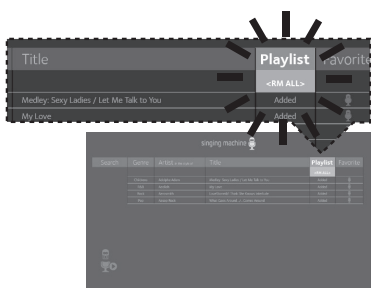
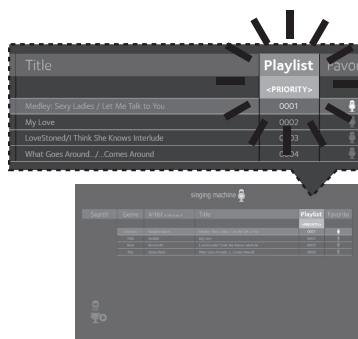
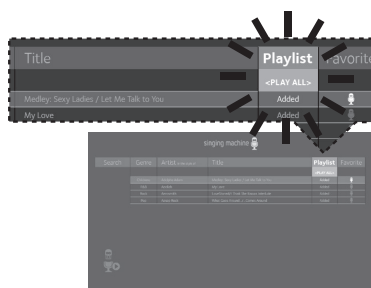

**17 USING THE PLAYLIST:** To play your previously created playlist, select **Playlist** using the **Navigation** ▶ right and ◀ left buttons, then press the **ENTER** ▶||| button; the row under Playlist will be highlighted. Select the desired selection using the **Navigation** ▶ right and ◀ left buttons as follows:

**TO PLAY ALL:** Select **Play All** and then press the **ENTER** ▶||| button to play back all of the Playlist songs. (See below to add favorites.)

### PRIORITY:

- Select priority and then navigate down to the song you want to prioritize.
- Press the **Navigation** ▶ Right button and the numbers will change to 0001, 0002 etc. According to the numbers displayed the songs will be listed in that order from top to bottom.
- After setting all songs on your priority list press the **MENU** button then the play list will be highlighted.
- Use the **Navigation** ▼ down button to select the first song and press the **ENTER** ▶||| button to start the playback of all songs on the play list
- To change the Priority list, navigate up and down to select the songs you want to play in the order you desire.

**REMOVE:** Select **Remove** and then select a song to remove using the **Navigation** ▲ up and ▼ down buttons. Press the **ENTER** ▶||| button; the song will be deleted.

**RM ALL:** To remove the whole Playlist, select **RM ALL** and then press the **ENTER** ▶||| button; the whole Playlist will be deleted.



# Operation

## Using a Bluetooth Device

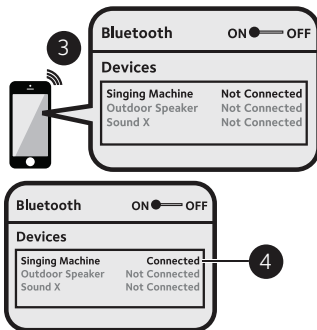
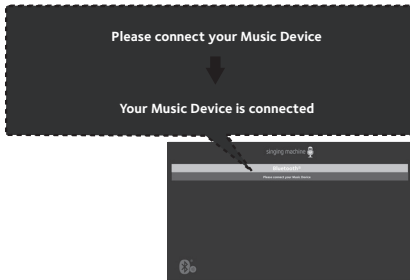
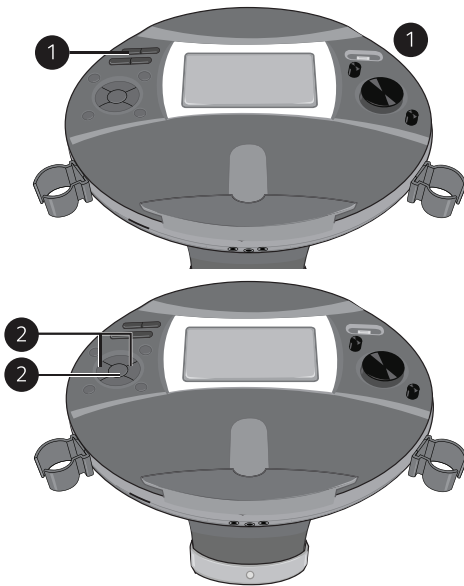

1 Connect the unit as described previously. Press the **ON/OFF** button ① to turn the unit on; the ON/OFF indicator will light blue.

2 Press the **Navigation** ▶ right or ◀ left button to select the Bluetooth mode. Press the **ENTER** ▶|| button; a tone will sound. The unit will automatically search for and pair to a previously paired Bluetooth device (if previously paired). If no previously paired devices are present, “Please connect your Music Device” will appear in the display.

**Note:** You can also press the **BLUETOOTH** button to disconnect any paired devices in order to pair another device.

3 Turn on your device’s Bluetooth option in settings to search for a discoverable device with a Bluetooth signal. Select “**Singing Machine**” from the device results on the Bluetooth menu.

**Note:** Also refer to the user manual of your Bluetooth device for detailed instructions.

4 A tone will sound and the monitor will display “Your Music Device is connected”.

### Notes:

- If your Bluetooth prompts you for a passcode during the pairing process, please enter “0000” to connect.
- On some Bluetooth devices (i.e., computers), once pairing is complete, you select your Bluetooth device as “Use as Audio Device” or similar.
- If connection is lost after successful pairing, check to make sure the distance between speaker and Bluetooth-enabled device does not exceed 30 ft/10 meters.

# Operation

## Using a Bluetooth Device (Continued)



**5** You can control your Bluetooth device to start the music playback OR press the **ENTER ▶||** button to start playback. Press the **ENTER ▶||** button during playback to pause the song.

**6** Adjust the volume to a comfortable level using the **MASTER VOLUME** control on this unit as well as the Volume on your Bluetooth device.  
**Note:** If connected to a TV, the Volume control on the TV will not adjust the volume on your Singing Machine.

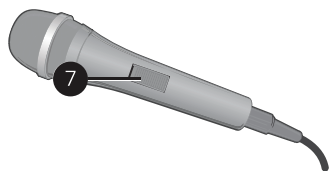

**7** Connect the microphone(s) as shown on page 8. Slide the Mic's **Power** switch to the ON position.



**8** Adjust the **MIC VOLUME 1** or **2** control as desired. Increasing this control will increase the volume of the respective microphone.

**9** Press **ECHO +/-** buttons to add an echo effect to your voice. The higher the number, the more echo effect.

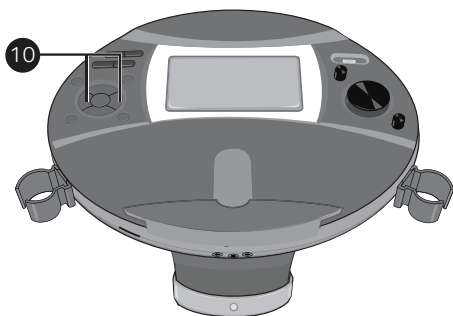

**10** **SKIP:** Advance or go back one track by pressing the **Navigation ▶** right or **◀** left button.

**Note:** Pairing remains intact when the unit and/or your Bluetooth device is taken out of communication range. An active connection will be re-established when your Bluetooth device returns within range. When the unit is turned on again, it will automatically try to reconnect with the most recently paired Bluetooth device.

# Operation

## Using a Bluetooth Device (Continued)

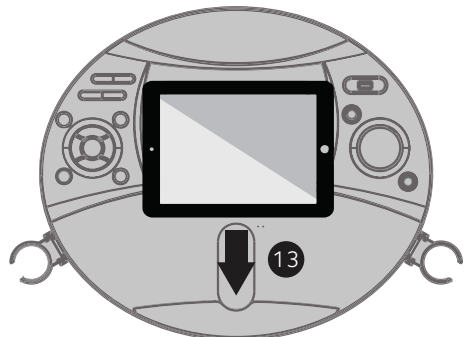
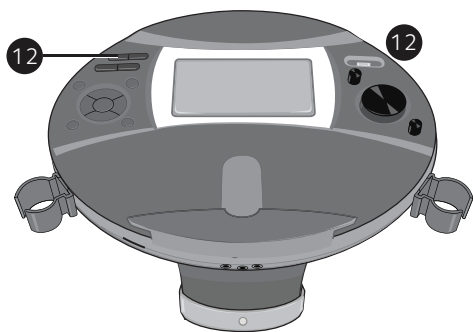
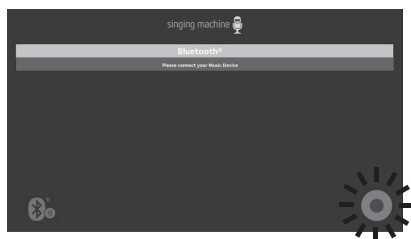
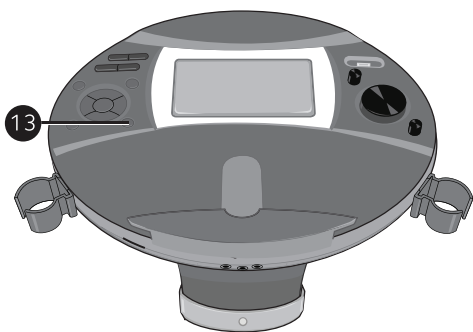

## 11 RECORD YOUR VOCAL PERFORMANCE:

To record your singing as well as the music, press the **RECORD** button. Recording will begin and the record icon at the bottom right of the monitor will blink red and blue.

When done recording, press the **RECORD** button again; the Record icon will stop blinking.

### Notes:

- If an SD card is inserted, the recorded audio file will record on it. If no SD card is present, then the recorded audio file will record onto the USB drive.
- The recorded audio file will be named with the "BT" prefix.
- See page 23 to play back your recorded files.

12 Press the **ON/OFF** button to turn the unit off; the ON/OFF indicator will turn off.

13 You can always place your Bluetooth device on the attached cradle after it is paired.

# Operation

## Playing Songs from the Recorded Files



1 Connect the unit as described previously. Press the **ON/OFF** button ① to turn the unit on; the ON/OFF indicator ② will light blue.

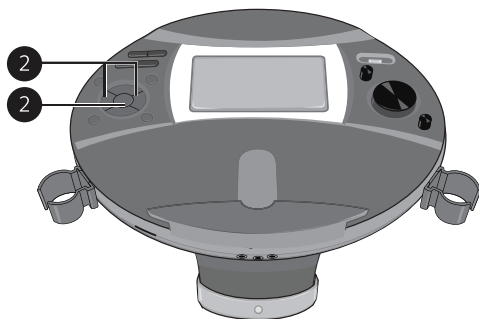

2 Press the **Navigation** ▶ right or ◀ left button to select the Recordings mode and press the **ENTER** ▶|| button to continue.

### Notes:

- The Recording mode cannot be entered unless a USB flash drive or SD card is inserted.



- A loading icon will appear when the system is loading the files.

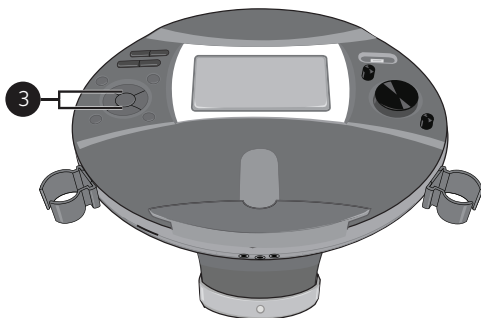

3 Use the **Navigation** ▲ up and ▼ down buttons to navigate through the list of recorded files to which you have previously recorded onto your USB or SD Card.

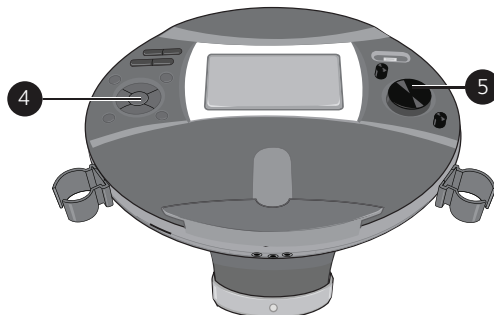
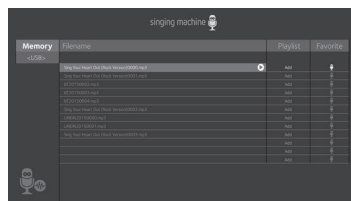

4 Press the **ENTER** ▶|| button to start the recorded audio file playback. Press the **ENTER** ▶|| button during playback to pause the file.

5 Adjust the volume to a comfortable level using the **MASTER VOLUME** control.





# Operation

## Using the LINE IN Jack



**1** Connect the unit as described previously. Press the **ON/OFF** button **1** to turn the unit on; the ON/OFF indicator will light blue.

**2** Connect the external unit to the LINE IN Jack on the rear of this unit. Connecting an external unit will allow the audio and video to be played through your Singing Machine.

### Notes:

- It is highly recommended to set the volume on the auxiliary unit to 1/3 or lower to avoid distortion.
- Skipping files/tracks is not possible when using an external device.

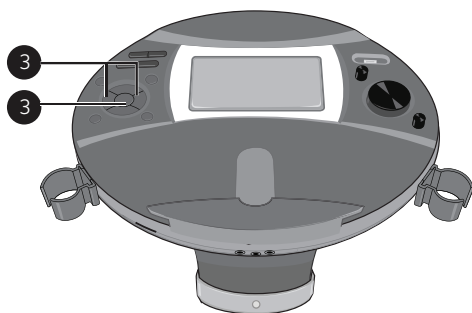

**3** Press the **Navigation** ▶ right or ◀ left button to select the Line In mode and press the **ENTER** ▶|| button to continue.



**4** Adjust the volume to a comfortable level using the **MASTER VOLUME** control on this unit or the Volume control on the external device.

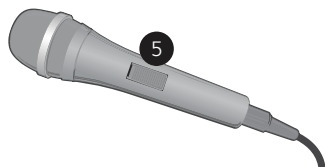

**5** Connect the microphone(s) as shown on page 8. Slide the Mic's **Power** switch to the ON position.

# Operation

## Using the LINE IN Jack (Continued)

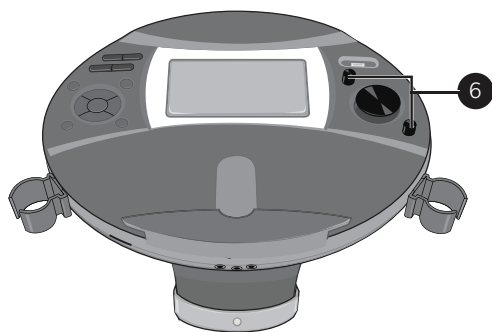

6 Adjust the **MIC VOLUME 1** or **2** control as desired. Increasing this control will increase the volume of the respective microphone.

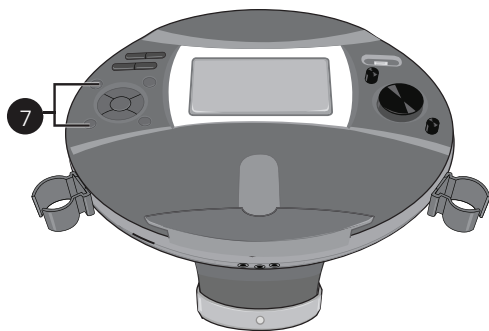

7 Press **ECHO +/-** buttons to add an echo effect to your voice. The higher the number, the more echo effect.



8 **RECORDING YOUR SINGING:**  
To record your singing as well as the music, press the **RECORD** button; recording will begin and the record icon at the bottom right of the display will blink red and blue.  
When done recording, press the **RECORD** button again; the Record icon will stop blinking.

### Notes:

- If an SD card is inserted, the recorded audio file will record on it. If no SD card is present, then the recorded audio file will record onto the USB drive.
- The recorded audio file will be named with the "LINE IN" prefix.
- See page 23 to play back your recorded files.

9 Press the **ON/OFF** button to turn the unit off; the ON/OFF indicator will turn off.

# Troubleshooting Guide

Should this unit exhibit a problem, check the following before seeking service:

## **No Power**

- Power is not on; press the **ON/OFF** button to turn power on.
- Confirm that the AC adaptor is connected securely to the back of the unit.
- Connect the unit to a different outlet.

## **No Sound – General**

- Master Volume is set to minimum; raise volume.
- Correct Function was not selected; select using the **Function** buttons.
- The Tower speakers are not connected.
- Headphones are still connected to headphones jack; unplug headphones.

## **No Sound – If connected to a TV**

- Volume on the TV is muted or too low.
- HDMI cable is not connected securely.
- Correct source (HDMI) was not selected in the TV's menu.

## **Lyrics do not appear on the screen**

- If connected to a TV, HDMI plug is not connected properly; see page 6.
- If connected to a TV, correct source (usually HDMI) was not selected in the TV's menu.
- The file/track being played is not a track recording with lyrics. These are the only files that allow you to view the lyrics on the screen.

## **No sound from the microphone**

- Make sure it is firmly connected to the MIC 1 or MIC 2 jack.
- Make sure the **ON/OFF** switch on the Mic is set to the On position.
- Make sure the **MIC VOLUME** controls are not on the lowest setting.
- **MASTER VOLUME** is set to minimum; raise volume.

## **File(s) on USB jack not playing**

- The file is corrupted; replace file.
- The file is not in a format this unit will play.
- The connected USB device is not supported by the product.

## **The Bluetooth device cannot be paired or connected with the unit.**

- You have not activated the Bluetooth function of your device; see page 20 or refer to the Bluetooth device user's manual.
- The system is not in pairing mode; press the **BLUETOOTH** button to restart pairing.

## **The Music is not available on the unit after successfully connecting the Bluetooth.**

- Ensure your Bluetooth device can support A2DP Bluetooth profile.

# Updating the Firmware

Make sure the **Singing Machine USB Flash Drive**, is securely plugged into the USB slot before running the update. DO NOT interrupt the update. If interrupted during the update process; the software can become corrupted and the unit will no longer function properly.

1. Create a folder on the **Singing Machine USB Flash Drive** named “user\_update”
2. Download the latest software (e.g xxxxxx.img) from **www.singingmachine.com/softwareupdates** and save it into this folder.
3. Plug the **Singing Machine USB Flash Drive** into the USB jack on the unit and turn the unit on.
4. The unit will update automatically.



The terms HDMI and HDMI High-Definition Multimedia Interface, and the HDMI Logo are trademarks or registered trademarks of HDMI Licensing Administrator, Inc. in the United States and other countries.



The Bluetooth® word mark and logos are registered trademarks owned by Bluetooth SIG, Inc. and any use of such marks by The Singing Machine Company, Inc. is under license. Other trademarks and trade names are those of their respective owners.

# Specifications

## AUDIO

Output Power ..... 7 Watts (RMS)  
Output Impedance ..... 3 Ohms

## BLUETOOTH

Bluetooth Version ..... V2.0 + EDR  
Working Distance ..... Up to 30 feet/10 meters measured in open space

## USB and SD

Format ..... FAT32  
Maximum Compatibility ..... 32GB

## RECORDED FILE

MP3 Encoding ..... 128kbps

## JACKS

Headphone Jack ..... 3.5 mm Stereo Headphones  
Microphone ..... 6.3 mm Microphone Jacks

## GENERAL

Power ..... DC 10V 4.0A  
Dimensions - Main Unit ..... 18.7 x 18.0 x 37.9 inches (47.5 x 45.5 x 96.3 cm)  
Dimensions - Tower Speakers ..... 6.7 x 7.9 x 27.7 inches (17.0 x 20.0 x 70.3 cm)  
Weight - Main Unit ..... 8.4 lbs (3.8 kg)  
Weight - Tower Speakers ..... 4.3 lbs (2.0 kg)  
Monitor ..... 7" Color TFT LCD NTSC  
Microphone ..... -74 dB 600 Ohms impedance with 6.3 mm Dynamic Microphone

Specifications are subject to change without notice.

Visit Our Website: [www.singingmachine.com](http://www.singingmachine.com)

The Singing Machine Company, Inc.  
4060 E Jurupa Street, Unit B  
Ontario, CA 91761-1413 USA

PRINTED IN CHINA

1060BT-1705-ENG01