

EPU - EVD ..... page 5

EVD DISPLAY - AVANTGARDE ..... page 11

## Read carefully

all parts of this manual before using the product.

The espresso coffee machine that you have purchased has been designed and manufactured with innovative methods and technology which ensure long lasting quality and reliability.

This booklet will guide you in discovering the advantages of purchasing this product. You will find notes on how to get the best out of your machine, how to always keep it efficient and what to do if you come up against any difficulties.

Keep this booklet in a safe place. If you lose it you can ask the manufacturer for another copy.

ENJOY YOUR READING ... AND YOUR COFFEE

## How to use this manual

The manufacturer has the right to make any improvements on the product. We also guarantee that this booklet reflects the technical state of the product at the time it is marketed.

We take the opportunity to invite the customers to make any proposals for improvement of the product or the manual.

## General warnings

- After removing the packaging, check the condition of the appliance. If in doubt, do not use it but contact the retailer directly.
- The packaging material must not be left in the reach of children in that they are a potential source of danger. It is advised to keep the packaging until after the guarantee has expired.
- Before using the machine, make sure that the mains voltage corresponds to the information on the data plate of the machine.
- The installation must be done in accordance with the safety standards in force and by qualified and prepared personnel. Incorrect installation may be harmful to people, property or animals.
- This appliance is completely safe only if it is connected to an effective earth system, executed as required by current safety standards. It is important to have compliance with this requirement checked. If in doubt, have the system carefully checked by qualified personnel. The manufacturer cannot be considered responsible for any damage caused by an incorrect grounding device.
- Upon installation of the machine, qualified personnel will be required to install a main switch as required by current safety regulations, with a distance of contact aperture greater than or equal to 3 mm.
- It is not advisable to use extensions or electrical adaptors with multiple outlets. If their use is indispensable only use simple or multiple plug adaptors and extensions which are in accordance with the safety standards in force. Never exceed the capacity value in kW indicated on the simple adaptor or on the extensions and the maximum power value indicated on the adaptor.
- The espresso coffee machine is intended for the preparation of hot beverages such as coffee, tea or warm milk. This appliance is to be used only for its intended purpose. Any other use is considered improper and therefore dangerous. The manufacturer cannot be responsible for any damage caused by incorrect and unreasonable use.
- Before any maintenance deactivate the appliance from the electrical network through the bi-polar switch.
- For daily cleaning follow that which is indicated in this manual.

- When using the electrical appliance several safety standards must be observed :
  - do not touch the appliance when hands or feet are wet or damp;
  - do not use the appliance in bare feet;
  - do not use extensions in rooms where there are showers or baths;
  - do not pull on the power cord to disconnect the appliance from the power outlet;
  - do not leave the appliance exposed to atmospheric agents (rain, sun, etc.)
  - do not allow the appliance to be used by children or incapable people.
- In case of breakdowns or poor functioning turn off the appliance, and unplug it. Do not attempt any repairs; call for specialised technical assistance.
- Any repairs must be done only by the manufacturer or an authorised assistance centre using exclusively original spare parts. If this instruction is not observed the safety of the appliance is compromised and cancels the guarantee.
- The power cord of the appliance must not be replaced by the user. If the cable is damaged turn the machine off and contact only professionally qualified personnel.
- If you should decide not to use the appliance any longer, unplug it and have it drained of water by qualified personnel.
- To guarantee that the machine is efficient for its correct functioning it is indispensable to follow the manufacturer's instructions, having periodical maintenance and a check of all the safety devices done by qualified personnel.
- Do not expose your hands or other body parts in the direction of the coffee delivery spouts or in the direction of the steam and hot water delivery terminals. The steam and the water that exit the nozzles can cause burns.
- When functioning, the steam and water nozzles and the filter-holder cups are overheated and are to be handled with care only in the indicated parts.
- Cups must be placed on the special cup-heating surface only after having been thoroughly dried.
- The dishes belonging to the machine itself are to be placed on the cup-heater surface. It is incorrect to place any other object.
- Any unauthorised handling of any parts of the machine renders any guarantee null and void.



#### **GUARANTEE**

12 months on all components except electrical and electronic components and expendable pieces.

## **P**resentation

The espresso coffee machine is for strictly professional use. It is designed for the preparation of hot drinks such as tea, cappuccinos and weak, strong and espresso coffee, etc. A range of accessories is available to guarantee practical and functional use of the machine.

If the model has two or more groups it can be used by two or more people simultaneously. This characteristic, together with the fact that the machine is able to deliver drinks continuously without any problems, guarantees its intensive use.

Following are the instructions for correct use of the machine. The various accessories supplied with the appliance will also be examined.



The user must have sufficient instructions to correctly operate the machine. It is recommended not to carry out any operations on the machine which can tamper with or alter its functionality. **WHEN THE MACHINE IS OPERATIVE THE BOILER CONTAINS STEAM AND HOT WATER THAT ARE UNDER PRESSURE.**



# EPU - EVD

1.	Machine description .....	page 6
2.	Push button panel .....	page 6
3.	Preparation of the machine .....	page 7
4.	Turning on the machine .....	page 7
5.	Grinding and dosing coffee .....	page 8
6.	Making coffee .....	page 9
	6.1 Version EPU .....	page 9
	6.2 Version EVD .....	page 9
7.	Preparation of hot drinks .....	page 10
	7.1 Hot water delivery (manual version) .....	page 10
	7.2 Hot water delivery (automatic version) .....	page 10
	7.3 Steam delivery .....	page 10
8.	Cup heater .....	page 10

# 1. Machine description

1. Cup heater surface
2. Push button panel
3. Machine start-up
4. Steam knob
5. Steam nozzle
6. Filter holder
7. Cup grille
8. Hot water nozzle
9. Gas safety (if included)
10. Gas ignition push button (if included)
11. Boiler / pump pressure gauge
12. Cup heater switch
13. Boiler level-check window

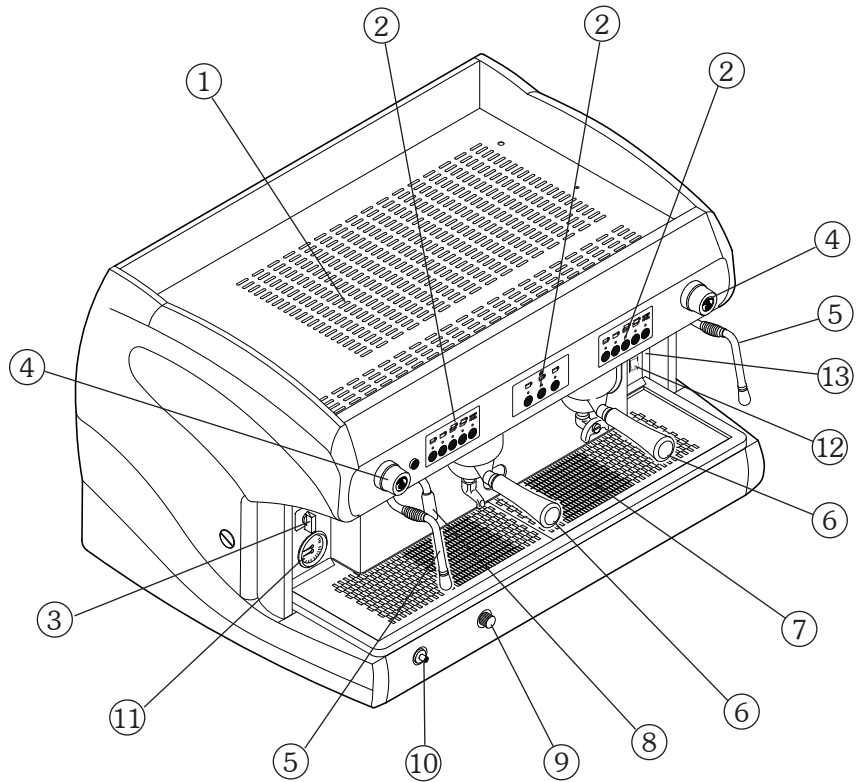

# 2. Push button panel

EPU

MANUAL  
coffee

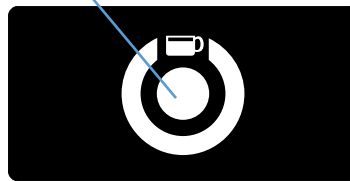

EVD

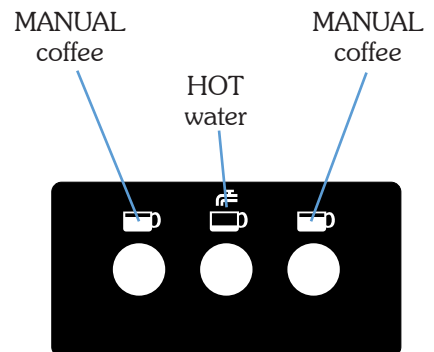
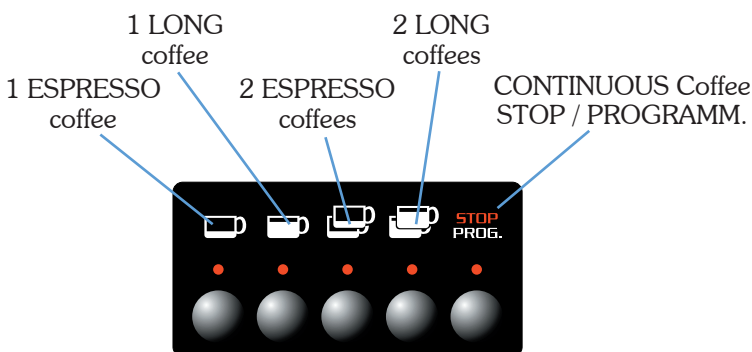

### 3. Preparation of the machine

The preparation of the machine and its installation must be carried out by qualified personnel.



Use of the machine without all the installation operations having been carried out by technical personnel could damage it seriously.

### 4. Turning on the machine

#### 4.1 Electric heating

Before starting the machine, make sure that the level of water in the boiler is higher than the minimum level on the level-check window **(1)**. If there is no water (first installation or after boiler maintenance), it is necessary to fill the boiler in advance, so as to prevent overheating of the heating element. Proceed as follows :

- Open the water tap of the water mains and of the softener.
- Turn the switch to position “**1**” (electrical power supplied to the pump for automatic boiler filling and machine services) and wait for the boiler to be automatically filled with water;
- Turn the switch to position “**2**” (full electrical power supplied, including the heating element in the boiler) and wait for the machine to warm up completely.

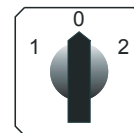
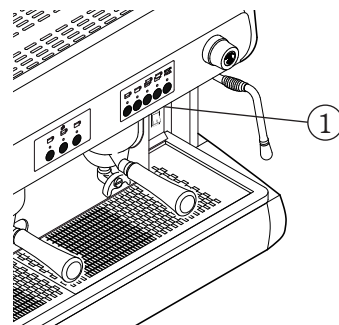

- during the machine's warm-up phase (roughly 20 minutes), the negative pressure valve will release steam for a few seconds until the valve itself closes
- before using the machine, run deliveries dry with the filter holder attached for a few seconds to release any air which may be in the circuit, so that the delivery groups are completely heated
- before using the machine, dispense a few servings of coffee to test the grinding and to check the operating pressure of the machine

#### 4.2 Gas heating (if there is a gas system)

- Turn the main switch **(A)** to position **1**;
- open the gas valve **(B)** on the mains;
- hold down the push button **(C)** and, at the same time, press the on button **(D)**. Once the flame ignites, hold down knob **(C)** for a few seconds, to allow proper activation of the thermocouple;
- then check through the window **(E)** that the flame has ignited;
- wait for the operating pressure indicated on the pressure gauge to reach the working value of 1-1.2 bar;

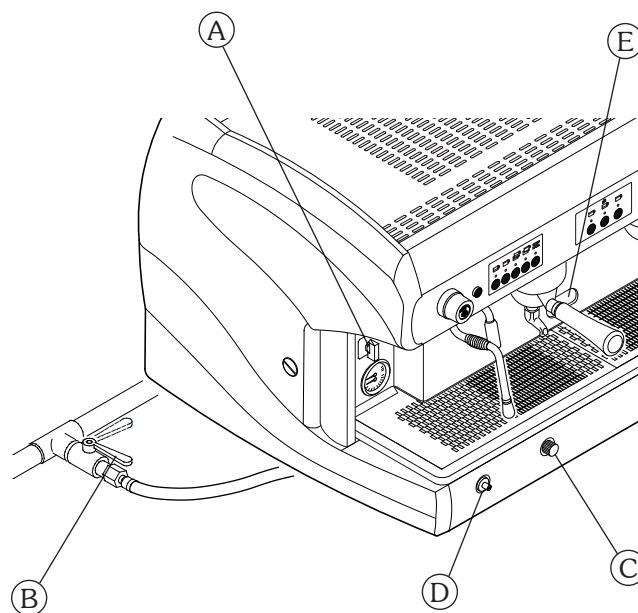

### 4.3 Electric + gas heating (if gas system is present)

- Proceed as indicated in paragraph 4.2 “Gas heating”;
- after checking that the flame has ignited, turn the main switch **(A)** to position **2**. In this way the boiler heating element is powered and operating pressure will be reached more quickly;
- wait for the operating pressure indicated on the pressure gauge to reach the working value of 1-1.2 bar;

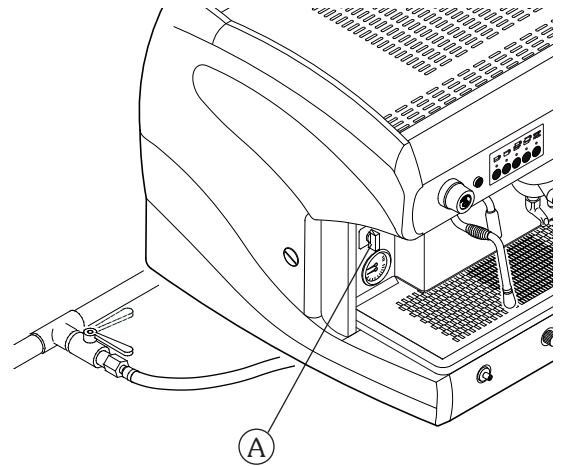

For reasons of safety, gas heating must be shut down during long periods of disuse of the machine (during the night or when the establishment is closed). It is not advisable to put cloths or other objects on the cup heater, as this obstructs normal air flow.

## 5. Grinding and dosing coffee

Place the grinder-doser in a convenient place near the machine. Grinding and dosing of coffee must take place in accordance with the instructions of the manufacturer of the grinder-doser. To achieve good quality espresso coffee we suggest the following:

- do not keep large amounts of coffee in whole beans. Observe the expiry date indicated by the producer;
- grind the volume of coffee based on use, place the amount the doser contains and if possible use it before the end of the day;
- if possible, never buy coffee that is already ground as it expires quickly. If necessary, buy it in small vacuum-sealed packages.

Fill the filter with a dose of ground coffee (circa 6-7 go.) and press it with the press. Attach the filter holder to the dispensing group.



To prevent the seal wearing too soon clean the edge of the filter before engaging the filter holder on the dispensing unit. Do not excessively tighten the filter holder to the dispensing group.



## 6. Making coffee

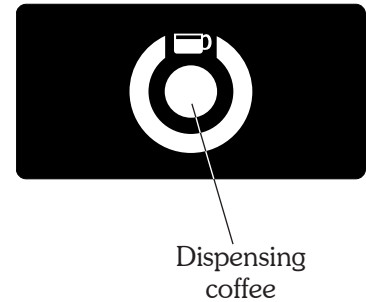

### 6.1 EPU version

- put the coffee cup under the dispensing spout.
- Press the desired delivery switch. You will have the delivery which can be stopped by means of the same switch once the desired amount of coffee in the cup is obtained.





### 6.2 EVD version

#### COFFEE DOSE PROGRAMMING

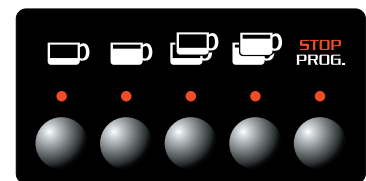
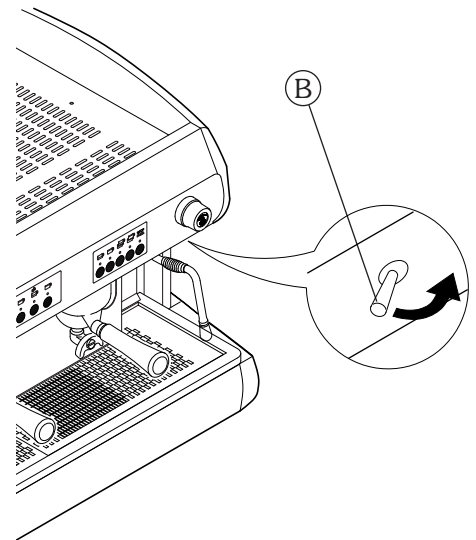
- Turn the programming switch **(B)** to the **ON** position;
- Hold the **STOP PROG.** key down for 5 seconds: all LED on the push button panel come on;
- Press the dose key to be programmed (e.g. 1 espresso coffee );
- Wait for dispensing. To confirm the dose press the dose key  or the key **STOP PROG.** again;
- Repeat this operation for the other dose keys;
- Upon conclusion of the programme, press the key **STOP PROG.** until all LEDs go off on the push button panel, and turn the programming switch **(B)** to **OFF**.



#### COFFEE DELIVERY

- put the coffee cup under the dispensing spout;
- press the desired dose key (e.g. 1 espresso coffee ) and wait for coffee to be delivered (LED comes on);
- to stop delivery of coffee in advance, press the delivery key again  or press the key **STOP PROG.** ;
- in the event of anomalies or if the push button panel is locked, use the manual delivery switch **(A)**.

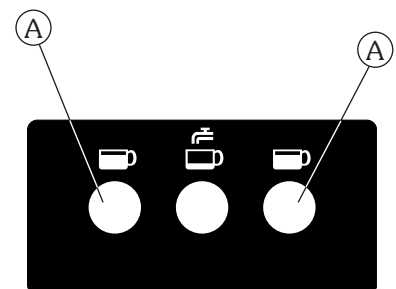

## 7. Preparation of hot drinks

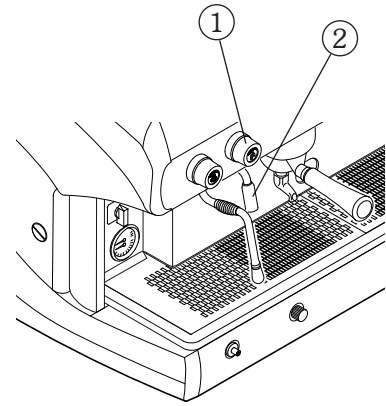

### 7.1 Hot water delivery (manual version)

To dispense hot water, turn the tap knob counter-clockwise (1): the hot water coming out of the nozzle (2) will be proportional to the opening of the tap.





### 7.2 Hot water delivery (automatic version)

#### PROGRAMMING DOSE OF HOT WATER

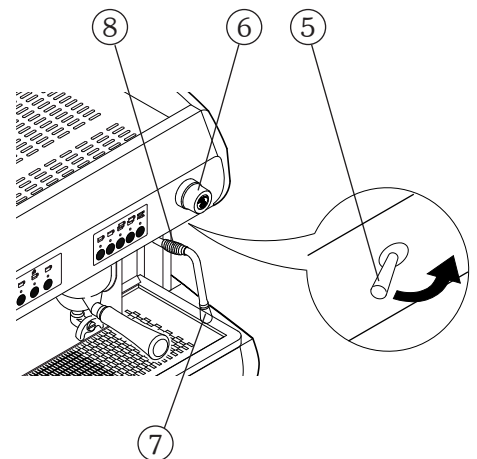
- Turn the programming switch (5) to **ON**;
- Put the cup under the hot water spout (2);
- press the Key (3) **STOP PROG.** on the right push button panel until all dose key LEDs come on;
- press the hot water delivery key (4)  ;
- upon reaching the desired dose confirm by again pressing the key for hot water delivery (4)  ;
- upon completion of programming, turn the programming switch (5) back to the **OFF** position.



#### DISPENSING HOT WATER

- Put the cup under the hot water spout (2);
- press the hot water key (4)  : wait for the delivery of water;
- to stop delivery in advance, press the hot water delivery key (4)  again.

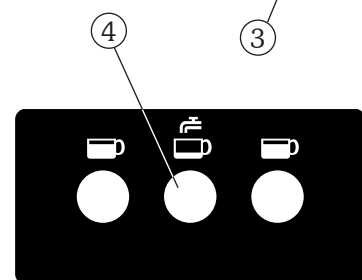
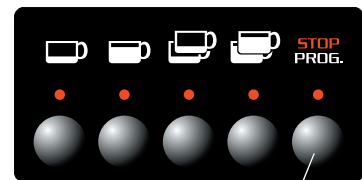

### 7.3 Steam delivery

To dispense steam, turn the tap knob counter-clockwise (6): the steam coming out of the nozzle (7) will be proportional to the opening of the tap.



Carefully move the steam nozzle with the anti-burn nozzle (8) and do not touch the hot water nozzle: contact with the hot water and steam may be harmful to individuals, animals or property.

## 8. Cup heater (if it is present)

To activate or deactivate the cup heater, turn the cup heater switch to **ON**.



placed above the turn on machine

# EVD DISPLAY - AVANTGARDE

1.	Machine description .....	pag. 12
2.	Push button panel .....	pag. 13
3.	Preparation of the machine .....	pag. 14
4.	Turning on the machine .....	pag. 14
5.	Grinding and dosing coffee .....	pag. 15
6.	Making coffee.....	pag. 15
7.	Dispensing hot water .....	pag. 16
8.	Dispensing steam .....	pag. 16
9.	Autosteamer.....	pag. 17
10.	Selection count .....	pag. 18
11.	Cup heater .....	pag. 18
12.	Luminous scrolling messages.....	pag. 19
13.	Programming of parameters of the machine .....	pag. 20
14.	Resetting data to zero .....	pag. 22
15.	Signals .....	pag. 23

# 1. Machine description

1. Cup heater surface
2. Push button panel
3. Display + Push button
4. Steam knob
5. Steam nozzle
6. Filter holder
7. Cup holding grille
8. Hot water nozzle
9. Gas safety (if included)
10. Gas ignition push button (if included)
11. Boiler / pump pressure gauge
12. Cup heater switch
13. ON switch
14. Autosteamer
15. Luminous scrolling messages
16. Steam nozzle autosteamer
17. Temperature probe
18. Boiler level-check window

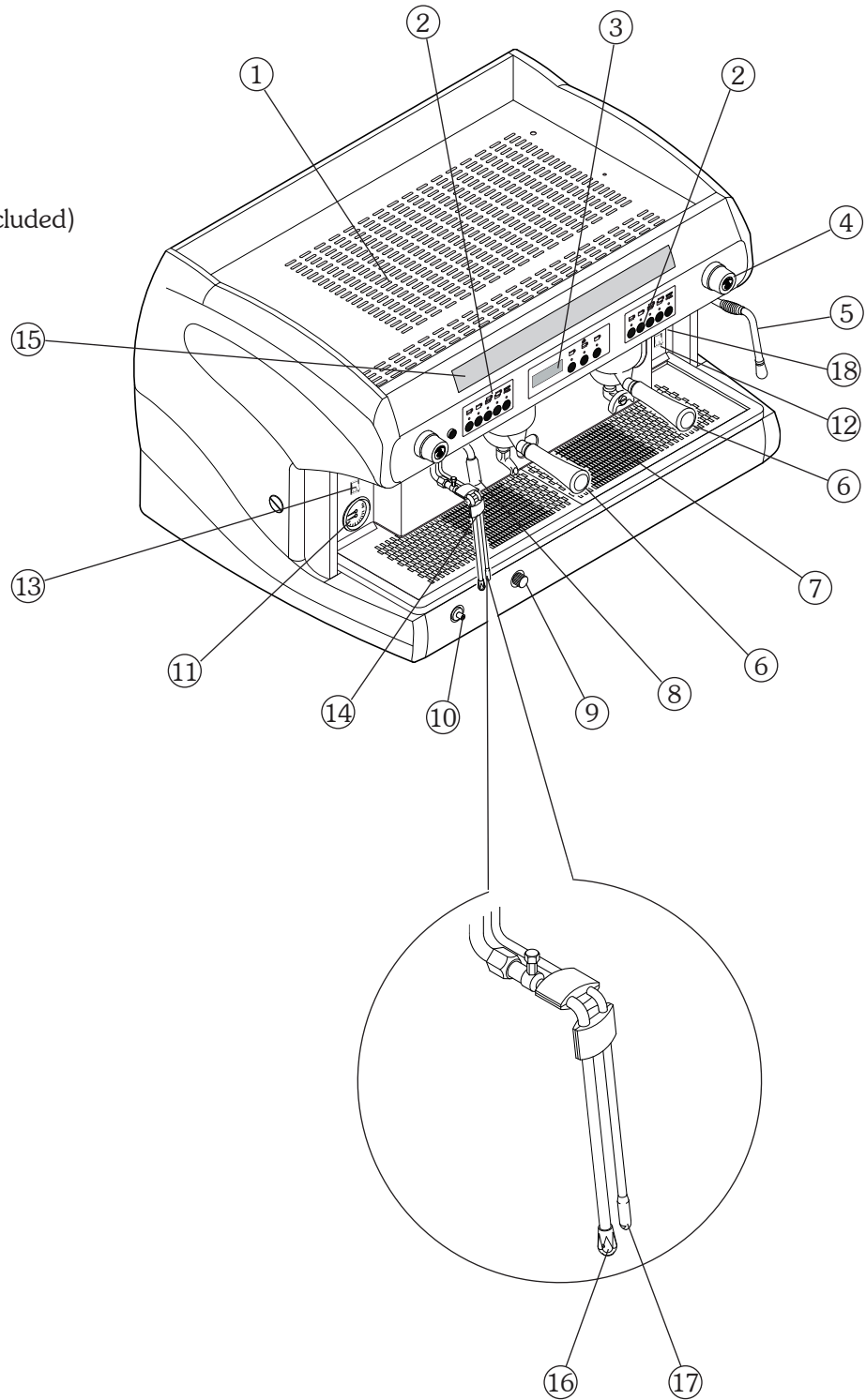

## 2. Push button panel

DISPLAY version

---

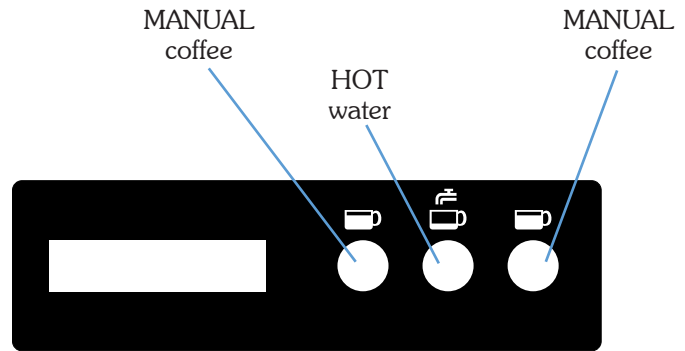

AUTOSTEAMER version

---

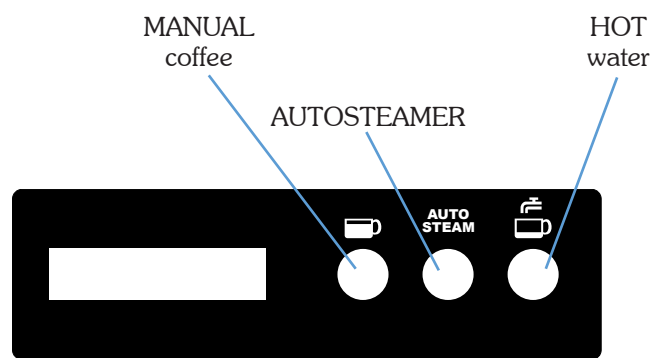

Key USE

---

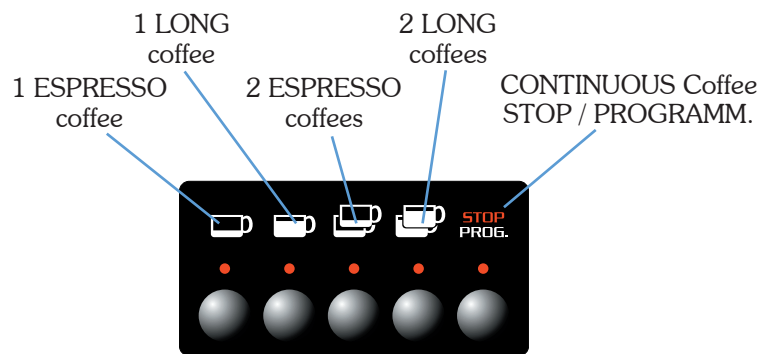

Key PROGRAMMING  
(only for the first push button right)

---

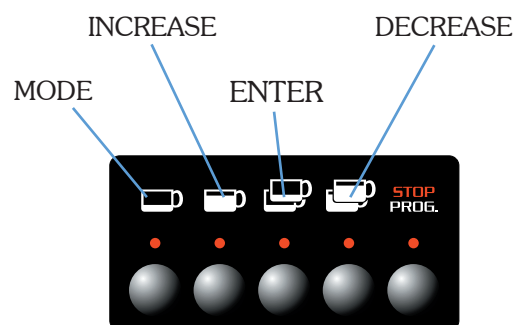

### 3. Preparation of the machine

The preparation of the machine and its installation must be carried out by qualified personnel.



Use of the machine without all the installation operations having been carried out by technical personnel could damage it seriously.

### 4. Turning on the machine

- Press in **ON** the main switch(**A**) of the machine;
- Wait for possible automatic re-filling of water in the boiler;
- Wait a few seconds longer for the auto-test to be carried out;

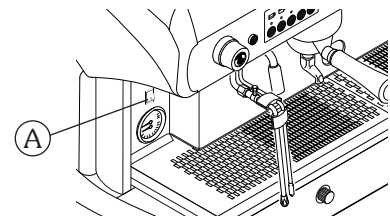

PLEASE WAIT FOR  
FUNCTIONAL TEST

TEST RESULT  
- OK -

- The machine is ready for use when the following message is displayed:

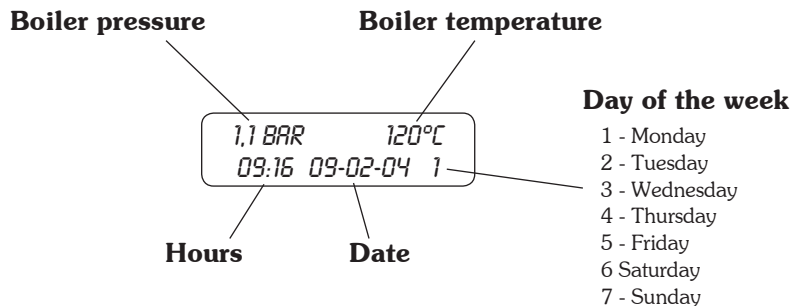

If the temperature is lower than 90° C (machine warm-up phase), the message **LOW** appears on the display.

With the programming key in the **ON** position, the machine can be partially switched off (heating element and selections disabled) also by simultaneously pressing the keys for 3 seconds. To put the machine back in service press again the keys simultaneously for 3 seconds.



- during the machine's warm-up phase (roughly 20 minutes), the negative pressure valve will release steam for a few seconds until the valve itself closes
- before using the machine, run deliveries dry with the filter holder attached for a few seconds to release any air which may be in the circuit, so that the delivery groups are completely heated
- before using the machine, dispense a few servings of coffee to test the grinding and to check the operating pressure of the machine

## 5. Grinding and dosing coffee

Place the grinder-doser in a convenient place near the machine. Grinding and dosing of coffee must take place in accordance with the instructions of the manufacturer of the grinder-doser. To achieve good quality espresso coffee we suggest the following:

- do not keep large amounts of coffee in whole beans. Observe the expiry date indicated by the producer;
- grind the volume of coffee based on use, place the amount the doser contains and if possible use it before the end of the day;
- if possible, never buy coffee that is already ground as it expires quickly. If necessary, buy it in small vacuum-sealed packages.

Fill the filter with a dose of ground coffee (circa 6-7 gr.) and press it with the press. Attach the filter holder to the dispensing group.





To prevent the seal wearing too soon clean the edge of the filter before attaching the filter holder to the dispensing unit. Do not excessively tighten the filter holder to the dispensing group.

## 6. Making coffee



### Programming coffee doses

For models with 2-3-4 groups it is possible to program simultaneously all machine push button panels using only the right push button panel. It is however advisable to check the programming of the other push button panels:

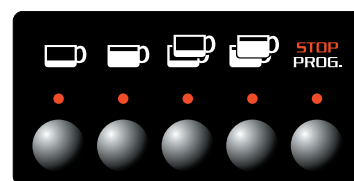
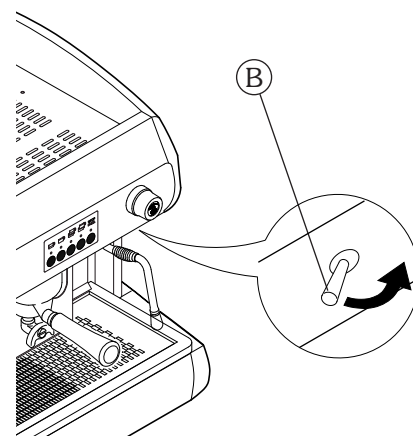
- Turn the programming key (B) to **ON** ;
- Hold the key **STOP PROG.** down for 5 seconds: all LED on the push button panel come on;
- Press the dose key to be programmed (e.g. 1 espresso coffee  );
- Wait for dispensing. To confirm the dose press the dose key  or the key **STOP PROG.** again;
- Repeat this operation for the other dose keys;
- Upon conclusion of the programme, press the key **STOP PROG.** until all LEDs go off on the push button panel, and turn the programming key (B) to **OFF**.



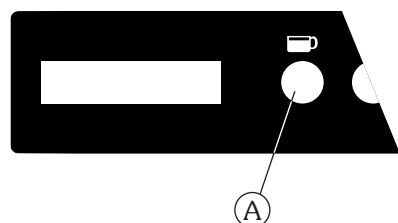

### Delivery of coffee doses

- put the coffee cup under the dispensing spout;
- press the desired dose key (e.g. 1 espresso coffee  ): wait for coffee to be delivered (LED comes on);
- to stop delivery of coffee in advance, press the delivery key again  or press the key **STOP PROG.** ;
- in the event of anomalies or if the push button panel is locked, use the manual switch (A).





## 7. Dispensing hot water

### 7.1 Hot water programming

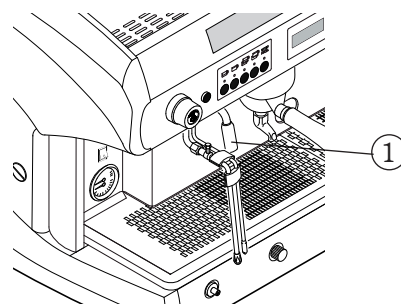
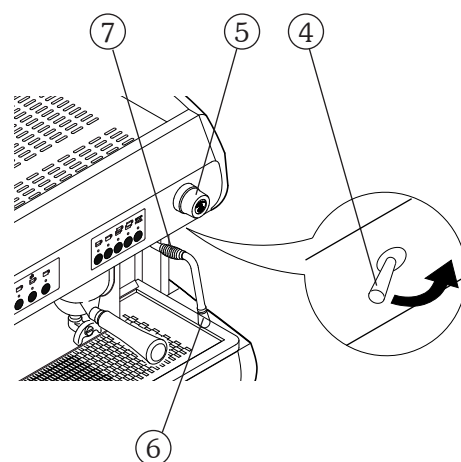
- Turn the programming key (4) to **ON** ;
- Put the cup under the hot water spout (1);
- press the key (2) **STOP PROG.** of the right push button panel, lighting all dose key LEDs;
- press the hot water delivery key (3)  ;
- when the desired dose has been attained, confirm by pressing the key (3)  ;
- upon completion of programming, turn the programming switch (4) back to the **OFF** position.



### 7.2 Hot water delivery

- Put the cup under the hot water spout (1);
- press the hot water key (3)  : wait for the delivery of water;
- to stop delivery in advance, press the hot water delivery key (3) again .

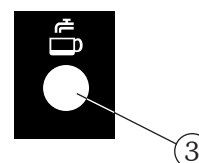
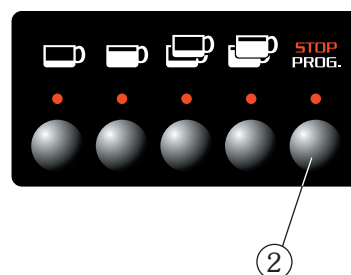

## 8. Dispensing steam

To dispense steam, turn the tap knob counter-clockwise (5): the amount of steam which comes out of the steam nozzle (6) will be proportional to the opening of the tap.



Handle the steam nozzle with care using the rubber anti-burn handle (7) and do not touch the hot water nozzle. Contact with steam and hot water may be harmful to people, property or animals



## 9. Autosteamer

### 9.1 Use

The autosteamer system makes it possible to make the milk foamy and to bring it up to a programmable temperature.

- 1) Immerge the ends of the autosteamer into the beverage to be heated;
- 2) Press the autosteamer key;
- 3) Wait for steam delivery to be completed.

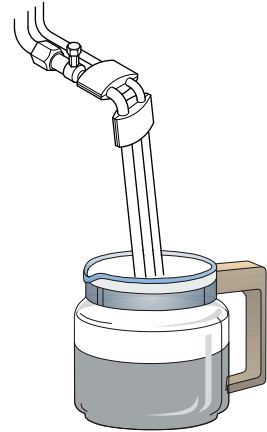
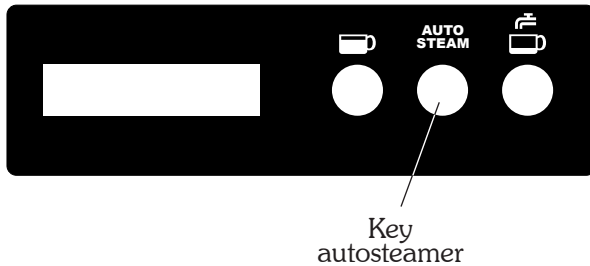





To stop delivery ahead of time, press the selected key again.



To keep the steam dispensers in perfect working order, it is advisable to carry out a delivery dry run after each use.  
Keep the ends of the autosteamer clean at all times by means of a cloth dampened in lukewarm water.  
Use the utmost caution with the autosteamer, as high-temperature steam is present.

### 9.2 HEATING TEMPERATURE adjustment

To adjust the activation temperature of the autosteamer, proceed as follows:

- Turn the programming switch **(1)** to the **ON** position;
- Hold down the key  of the upper left hand push button panel for at least 5 seconds;
- Repeatedly press the key  until the display shows the message 
- Use the keys   to modify the temperature of the autosteamer shown on the display;
- Keep the key **STOP PROG.** pressed to confirm the operation ;
- To exit programming, press the key **STOP PROG.** (the machine automatically exits programming if no selections are made for at least 10 seconds) ;
- Upon completion of programming, turn the programming switch **(1)** back to **OFF** .

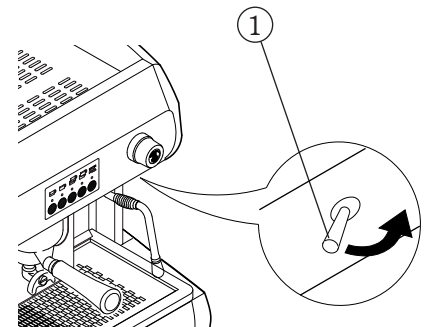

The system includes a maximum operation time of 4 minutes for the autosteamer.

### 9.3 MILK FOAMING adjustment

To adjust milk foaming with the autosteamer, proceed as follows:

- Use a wrench to unscrew component **(A)** of the steam nozzle;
- Use a screwdriver on the screw **(B)** located inside the part:
  - to reduce foaming turn clockwise
  - to increase foaming turn counter-clockwise

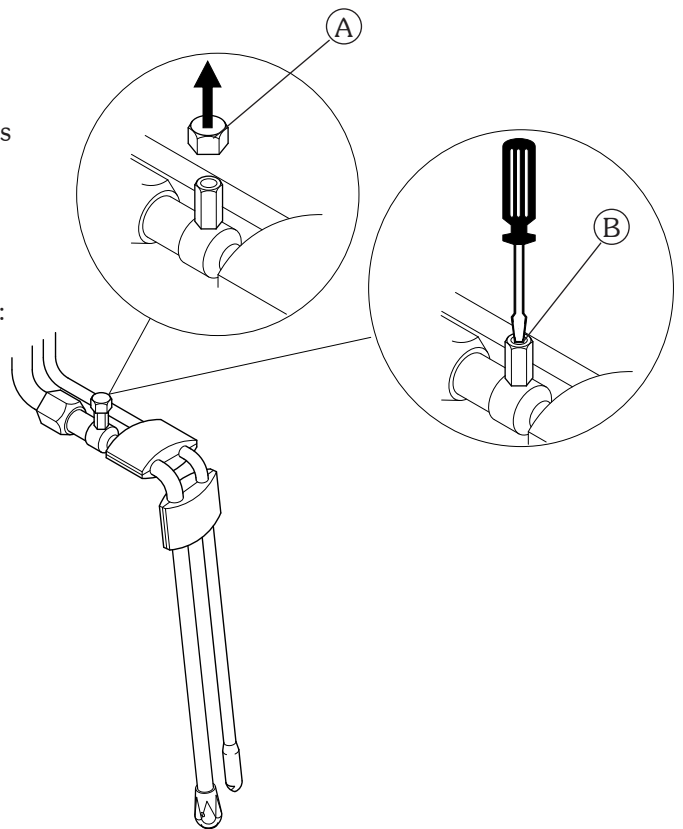

## 10. Selection count

To view the sum of work performed by the machine, proceed as follows:

- 1) Turn the programming switch to the OFF position;
- 2) Keep the key **STOP PROG.** of the left push button panel pressed for at least 5 seconds until the display shows the total number of selections carried out;
- 3) By pressing the keys on the coffee selection push button panel or on the selections push button panel, it is possible to view the number of selections made with that key;
- 4) Press twice the key **STOP PROG.** to exit counts.

TOTAL COFFEES  
000000

COUNTERS  
000000



To reset the counts see chap 14 - "Data resetting"

## 11. Cup heater (if it is present)

To activate or deactivate the cup heater, turn the cup heater switch switch to **ON**.



placed above the turn on machine





## 12. Luminous scrolling messages

### 12.1 Characteristics

- Possibility to insert a message (maximum 50 characters) with dedicated programmer;
- Possibility to modify speed of text scrolling with dedicated programmer.





### 12.2 Message programming

- With the machine off, connect the hand-held programmer and then power on.
- The display will show a flashing cursor on the first digit.
- To insert the character, press the "RIGHT ARROW" key . With the key held down, the characters scroll. Release the key when you reach the desired character.
- To memorize the character, press "ENTER" .
- The cursor will now move to the next character.
- Proceed in the same way for the other digits.
- You can insert spaces in the message by pressing the "SPACE" key . You can delete an incorrect character with the "DEL" .
- When you have finished, press "END"  to memorize the message.
- Turn the programmer off and disconnect it. Turn the machine back on, and the message will start scrolling on the display.



### 12.3 Programming of parameter for speed of message scrolling

- With the machine off, connect the hand-held programmer. While holding down the "ZERO" key , power on the machine.
- The display will show the message "PROG SPEED".
- Type in a speed value between 1 and 5 (1=slow 5=fast) then press "ENTER" .
- The display will show the message "END", meaning that the parameter has been programmed.
- Turn the programmer off and disconnect it. Turn the machine back on.

## 13. Programming of parameters of the machine

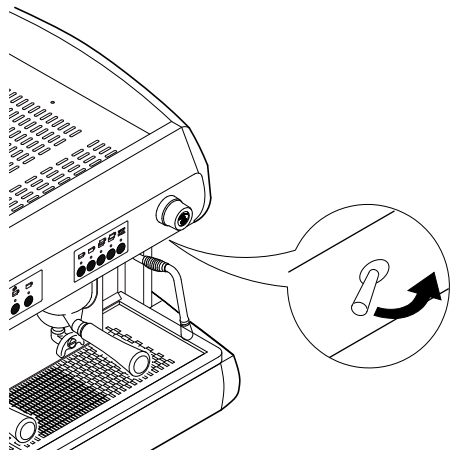

Turn the programming switch to the **ON** position (**P** flashes on the display).

Keep the MODE key  pressed for at least 3 seconds to have access to programming.

To scroll through the various areas of the programming menu (see alongside) use the MODE key .

Use the ENTER key  to move from a parameter to the next one within the same area.

To modify the value of each parameter, use the increase  and decrease  keys.

**i**

The system automatically exits the programming phase after about 20 seconds from the last operation carried out. When programming is finished, turn the programming switch back on **OFF**.



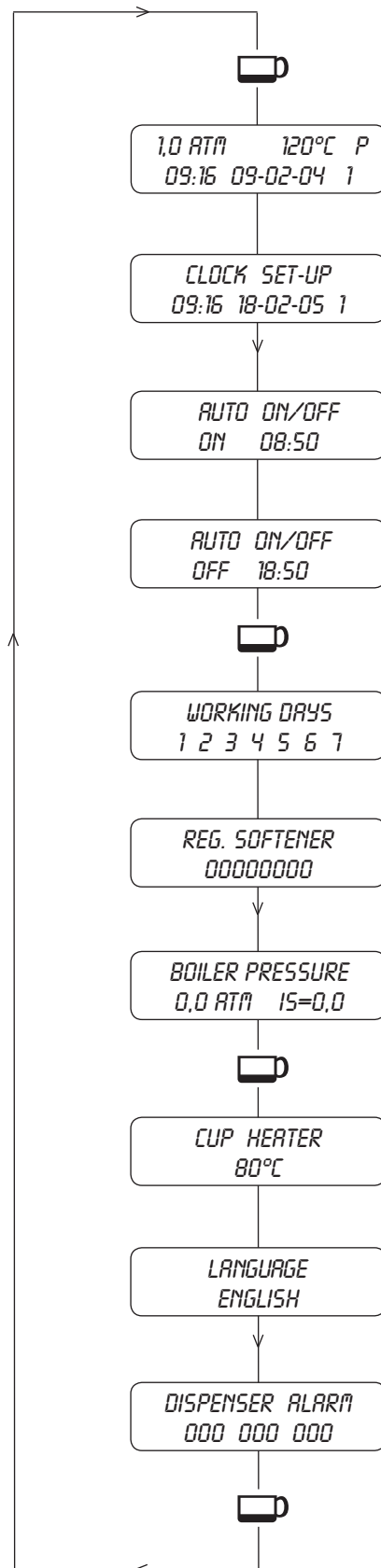

**i**

With the programming switch in the **ON** position, the selections are not active.



## 13.1 Programming of CLOCK and DATE



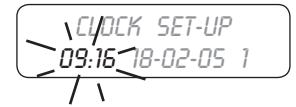

Change of hour, date and day of :

- 1) Enter programming until showing on the display :
- 2) Keep the MODE key  pressed for 3 seconds;
- 3) modify the parameter while flashing with the keys   ;
- 4) to move to the next parameter press the key ENTER  ;
- 5) to move to subsequent programming press the key MODE  .



## 13.2 START-UP programming





Programming of the automatic switching on of the machine:

- 1) Enter programming until showing on the display :
- 2) set the machine start-up time with the keys   ;
- 3) to move from hours to minutes and vice versa press the key ENTER  ;
- 4) to move to the subsequent programming press the key MODE  ;
- 5) to deactivate the "Start-up" function, set the time to 00:00 .



## 13.3 SHUT DOWN programming

Programming of the automatic switching off of the machine:

- 1) Enter programming until showing on the display :
- 2) set the shutdown time of the machine with the keys   ;
- 3) to move from hours to minutes and vice versa press the key ENTER  ;
- 4) to move to the subsequent programming press the key MODE  ;
- 5) to deactivate the "Shut down" function, set the time to 00:00 .



The "Start-up" and "Shut down" functions are active only for the days of the week when the "Rest day" function has not been activated.

## 13.4 REST DAY programming



To program machine shutdown for rest day(s), follow the instructions below:

- 1) Enter programming until showing on the display :

**Days  
of the  
week**

1 - Monday	5 - Friday
2 - Tuesday	6 - Saturday
3 - Wednesday	7 - Sunday
4 - Thursday	

### Shutdown

- 1) Choose the day(s) for shutdown by scrolling with the keys   ;
- 2) Use the key ENTER  to set the dash " - " at the day(s) of desired shutdown.

### Switching ON

To eliminate machine shutdown, use the ENTER key  to reset the numerical value of the day .

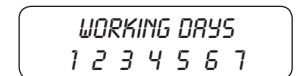

Example of machine shutdown on Tuesday and Thursday



Example of machine with no days set for shutdown

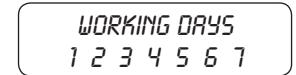

For days of the week in which the "Rest day" function has been activated " - " the machine will remain off .

## 13.5 WATER SOFTENER REGENERATION programming

Programming of the automatic warning of water softener regeneration:

- 1) Enter programming until showing on the display;
- 2) set the amount of water (steps of 50 litres) with the keys ;
- 3) to move to the subsequent programming press the key MODE .

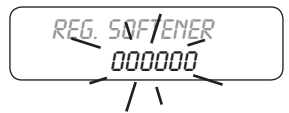

**i**

When the machine reaches 90% of the value set on the display a signal appears for 5 seconds. When the machine reaches 100% of the value set on the display a blinking signal appears.

To eliminate the blinking signal and reset the count of the litres of water to zero, with the programming switch in the ON position press the 4 keys of the left push button panel simultaneously until the display shows the message "CLOCK SET UP".

The regeneration control is bypassed by setting a value equal to 00 litres.

## 13.7 LANGUAGE programming

Programming of the language displayed:

- 1) Enter programming until showing on the display;
- 2) set the language with the keys ;
- 3) to move to the subsequent programming press the key MODE .



**i**

In English it is possible to choose between degrees Celsius (°C) and Fahrenheit (°F)

## 13.8 DOSERS alarm

Control of the dispensers alarm. The 3 values displayed correspond to the delivery groups.

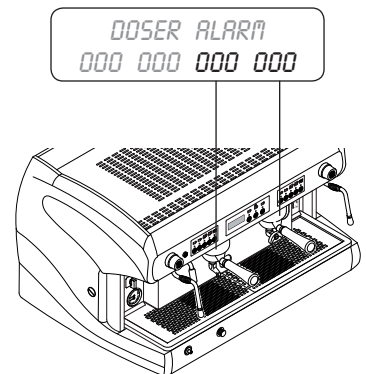

## 14. Resetting data to zero

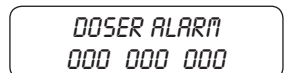
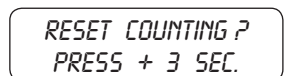

### 14.1 Resetting of dosers alarm

- 1) Place the programming switch in the **ON** position ;
- 2) with the key MODE scroll the menu until the dispenser alarms;
- 3) to start resetting press the key ;
- 4) to confirm resetting press the key for 3 seconds;
- 5) upon completion turn the programming switch back to **OFF**.







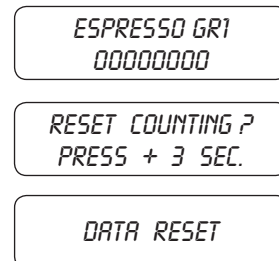
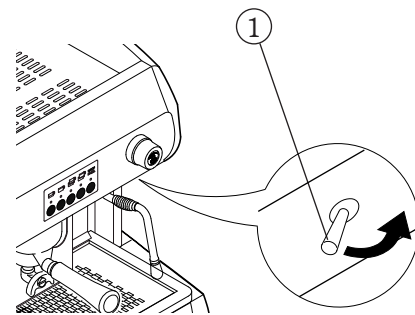

## 14.2 Resetting selection count to zero

- 1) Place the programming switch (1) in the **OFF** position ;
- 2) hold down the key **STOP** **PROG.** of the left push button panel for 5 seconds;
- 3) place the programming switch (1) in the **ON** position ;
- 4) to start resetting press the key  ;
- 5) to confirm resetting press the key  for 3 seconds.



The procedure described above makes it possible to reset the counts of the single selections (group 1-2-3, milk selections), but not to reset the machine completely (machine life cycle).

## 15. Signals

	cause	solution
<i>1,1 ATM 120°C BOILER FILLING</i>	Boiler filled with water when using the machine for the first time or when refilling to reach the water level.	Wait for the boiler to be completely filled.
<i>1,1 ATM 120°C FILLING TIMEOUT</i>	Time for filling the boiler with water longer then expected.	Make sure the mains cock is opened. Switch off and on again the machine. If the warning is still on after a few interventions call the Technical Assistance.
<i>DOSER ALARM</i>	Fault of the volumetric electronic control .	Stop brewing by pressing the dose key. Call the Technical Assistance.
<i>REG. SOFTENER</i>	Lack of water softener regeneration.	Carry out the water softener regeneration. To put off the warning turn the programming switch on ON and press simultaneously the 4 display keys for 5 seconds     .



If the right keypad of the machine does not work, it may be due to incorrect positioning of the programming switch (set to **ON**). Make sure that the programming switch is always **OFF**.



If the machine will not work call technical assistance.

# Softener

Mains water contains insoluble salts, which cause the build-up of lime scale deposits in the boiler and in other parts of the machine. The softener makes it possible to eliminate or substantially reduce the presence of these mineral salts.

The resin softener has the property of retaining the calcium contained in the water. For this reason after a certain period the resins are saturated and are to be regenerated with coarse kitchen salt (NaCl, sodium chloride) or special water softening salt. It is very important to regenerate the softener within the established times.

The regeneration is to be done regularly every 15 days. However, in locations with very hard water, it will be necessary to regenerate more frequently. The same is true of places in which there is a large consumption of hot water for tea or other uses.

## Softener regeneration

Proceed as follows:

- move levers **(2)** and **(5)** from left to right;
- Remove the lid by loosening the knob **(1)**.
- Release enough water through the pipe **(3)** to make room for the amount of salt as required depending on the model (see table).
- Clean any salt or resin residue from the gasket located on the lid.
- Put the lid back in place by screwing the knob **(1)** down securely and move the lever **(2)** back from right to left.
- Let the salt water drain from the small tube **(4)** until the water is no longer salty (about 30-60 minutes). The salt allows the accumulated mineral salts to be released.
- Bring the lever **(5)** from right to left back to its initial position.

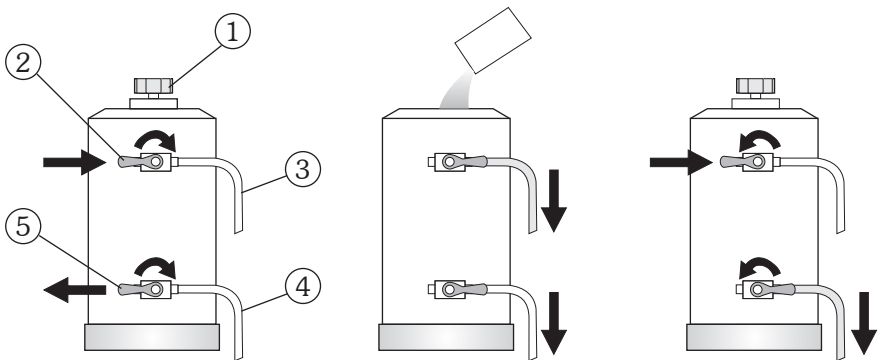

Model softener	Amount of salt
8 litres	1.0 kg
12 litres	1.5 kg
16 litres	2.0 kg



The build-up of lime scale in the hydraulic circuit and boiler inhibit thermal exchange, thus compromising proper operation of the machine. Heavy incrustation in the boiler may cause long machine shutdowns and in any case invalidate any guarantee, because this symptom indicates that regeneration has been neglected.

In order to keep the softener and hence the machine in perfect operating condition, it is necessary to perform regeneration periodically based on the use of the softener and the hardness of the water that is used.

The table alongside shows the values of the quantity of softened water based on the hardness of the water in the various units of measure:

- F°: French degree
- D°: German degree = 1.8 °F
- mg CaCO<sub>3</sub>

Amount of softened water based on hardness					
F°	30°	40°	60°	80°	salt
D°	16.5°	22°	33°	44°	
mg CaCO <sub>3</sub>	30	40	60	80	
<b>8 litres</b>	1000 lt	900 lt	700 lt	500 lt	1.0 kg
<b>12 litres</b>	1500 lt	1350 lt	1050 lt	750 lt	1.5 kg
<b>16 litres</b>	2100 lt	1800 lt	1400 lt	1000 lt	2.0 kg

For further information on installation, start-up and regeneration of the softener, refer to the relative instruction manual.



# Cappuccino maker

- Put the suction tube inside the milk;
- place the jug under the spout of the cappuccino maker;
- turn the steam tap counter-clockwise, upon reaching the desired amount, close the steam tap;
- pour the foamed milk into the cups with coffee.

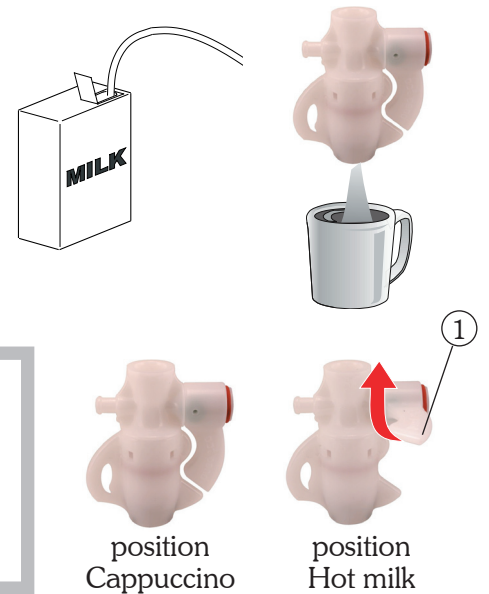

To obtain delivery of warm milk without foam, lift the tab (1) upwards. For better results, we suggest not dispensing directly into the coffee cup, but into a jug or pot, then putting the foamed milk with the coffee.  
Be sure the cappuccino maker is kept clean as described in the chapter "Cleaning".

## Cleaning

Use special care in cleaning the cappuccino maker, following the procedures indicated here:

- initially wash by placing the immersion tube in water and run a delivery for a few seconds;
- turn the rotating body (1) 90° to **pos.B** (closure of milk outlet duct);
- holding the aspiration tube in the air, dispense steam (cappuccino maker dry run);
- wait about 20 seconds to allow for internal cleaning and sterilisation of the cappuccino maker;
- close the steam and put the rotating body back in **pos.A**;
- if the air intake hole is blocked (2), clear it gently with a pin.

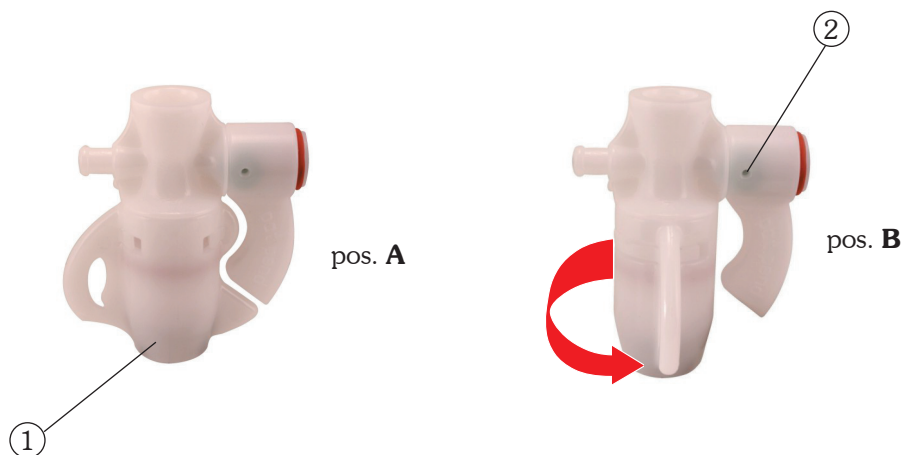

It is advisable to clean the cappuccino after each period of continued use so as to avoid malfunctions and to ensure the hygiene of the system.

# Cleaning

For perfect cleaning and efficiency of the appliance, several simple cleaning operations are necessary on the functional parts and accessories as well as the body panels. The indications given here are applicable for normal use of the coffee machine. If the machine is heavily used then cleaning should be performed more frequently.

## Filter and filter-holder

The filters and the relative filter-holders must be cleaned daily in hot water. The best thing to do is to let them soak in hot water overnight so that the fatty coffee deposits can dissolve.

It is advisable to add an envelope or tablet of special detergent to the water, and then to rinse everything off with water.

Failure to clean the filters and filter holders daily will compromise the quality of the coffee and will also cause problems such as bad extraction and coffee grounds at the bottom of the cup.

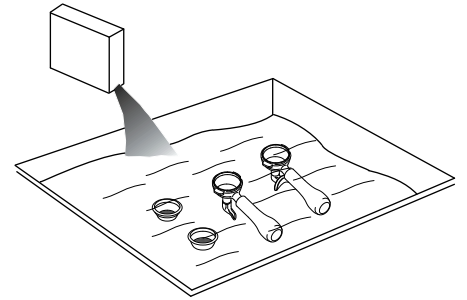

## Steam nozzles

The steam pipes must be kept clean at all times. Check the ends of the steam nozzles and clean them monthly, clearing out the exit holes with a small needle.

## Delivery groups

The cleaning of the internal parts of the delivery groups is to be performed weekly in the following manner:

- replace the normal filter of the filter-holder with a solid one;
- pour a teaspoon of a suitable detergent powder on the solid filter, and attach the filter-holder to the group;
- use the delivery switch to set the group in operation;
- repeat the above operations until the water comes out clean;
- turn off and remove the filter-holder from the group;
- rinse a final time, so as to remove any residual detergent.

## Body

The body panels should be cleaned with a cloth soaked in warm water. Do not use abrasive detergents since the panels could get scratched.

## Grinder-doser

Every week clean the bell jar and the dosing device with a cloth soaked in lukewarm water, both inside and out.



When cleaning, always use cloths that are completely clean and hygienic.

## Checks and Maintenance

To ensure perfect safety and efficiency of the machine over time, it is necessary to carry out maintenance. In particular, it is advisable to ask Technical Service to carry out an overall check of the machine at least once a year.

### Automatic

Check the following on a regular basis:

- check pump pressure with a pressure gauge which should indicate a pressure of around 8-9 bar. In case of anomalies contact technical service;
- also with a pressure gauge, check the boiler pressure, which should be about 0.8-1.2 bar. This may also require the assistance of technical service;
- check the wear of the filters, if there is damage to the edges and check if coffee grounds are getting into the cup. If necessary replace the filters.

### Grinder-doser

Check the following on a regular basis:

- check the dose, which should be about 6-7 gr. at a time and adjust the amount as necessary;
- always monitor the degree of grinding and modify as required;
- check the wear of the grinders. They will need to be replaced if there is too much powder in the ground coffee.

### Softener

Do the following on a weekly basis:

- perform regeneration of the softener as described in chapter 9 (for the softener in the manual version);
- check that there is salt in the container (for the softener in the automatic version).

## Suggestions on how to obtain a good cup of coffee

To obtain a high-quality coffee, it is important that water hardness of the water used does not exceed 4-5 °F (French degrees). In the water hardness exceeds these values, it is advisable use a water softener.

Avoid using a water softener if water hardness is less than 4 °F. If the taste of chlorine in the water is especially strong, a special filter should be installed.

It is not advisable to keep large stores of coffee beans. Never grind large amounts of coffee. Use the amount the doser holds and if possible use it by the end of the day. Never purchase ground coffee as it expires quickly.

After the machine has not been used for a period of time (2-3 hours) make a few dry runs. Be sure to carry out regular cleaning and maintenance.

# List of hazards

This chapter describes possible hazards for the user if the specific safety standards described in this booklet are not adhered to.

## **The appliance must be connected to an efficient grounding system**

If this is not done, the appliance can be a source of dangerous electrical discharges in that it is no longer able to discharge electricity to earth.

## **Do not use running water to wash**

The use of pressurized water directly on the machine can seriously damage electrical appliances. Never use water jets to wash any part of the appliance.

## **Be careful with the steam nozzles and hot water**

During use, the steam nozzles and hot water may overheat, thus becoming a source of danger. Handle such parts carefully. Never direct steam or hot water jets directly on parts of the body.

## **Do not work on the machine when it is supplied with electrical power.**

Before carrying out any intervention on the machine you must turn it off by means of the main network switch or better yet, disconnecting the connection terminals in the network. Never remove any body panel when the machine is supplied with electrical power.

## **Never work on the hydraulic system before having emptied it.**

All work regarding the hydraulic system and the relative boiler are to be avoided when there is still water and pressure in the system. You must therefore empty it beforehand, closing the mains cock and dry-running the delivery group for a short time. Switch off the machine and open all the steam and water cocks and taps. With the pressure zero, completely empty the boiler, unscrewing the special pipe fitting situated on the lower part of it.

If the above procedure is not correctly carried out, opening any part of the hydraulic system can cause a sudden outlet of overheated water under pressure.

## **Gas machines**

Periodically check for gas leaks in the system by applying a soapy solution to the ducts.

For safety reasons, close the gas heating system when the machine is not in use (at night or during hours of closure)

## **Use of the appliance**

This espresso coffee machine is an appliance exclusively for professional use. Any other type of use is considered wrong and therefore dangerous. Never allow children or incapable persons to use the machine.

Non-observance of the above-described standards can cause serious harm to people, property or animals.

Never work on the electronic apparatus when the machine is still supplied with electrical energy.

Shut down the machine completely by unplugging it from the mains before carrying out any operation.



**WEGA s.r.l.**

Via Condotti Bardini, 1 - 31058 SUSEGANA (TV) - ITALY  
Tel. +39.0438.1884811 - Fax +39.0438.1884890  
[www.wega.it](http://www.wega.it) - [info@wega.it](mailto:info@wega.it)

Cod. WY02000247 - Rev. 01 - 09/2006