



# Multi-spectrum Binocular HABROK Series

User Manual V5.5.80 202311



Contact Us

## Table of Contents

Chapter 1 Overview .....	1
1.1 Brief Description.....	1
1.2 Function.....	1
1.3 Appearance.....	2
Chapter 2 Preparation .....	5
2.1 Install Battery.....	5
2.1.1 Battery Instruction .....	5
2.1.2 Battery Installation .....	5
2.2 Cable Connection.....	6
2.3 Mount Neck Strap .....	7
2.4 Mount Tripod Adapter .....	9
2.5 Power On/Off.....	9
2.6 Auto Screen Off.....	10
2.7 Menu Description.....	11
2.8 App Connection.....	11
2.9 Firmware Status .....	12
2.9.1 Check Firmware Status.....	12
2.9.2 Upgrade Device .....	13
Chapter 3 Image Settings .....	14
3.1 Adjust Device.....	14
3.2 Adjust Brightness.....	15
3.3 Adjust Contrast .....	15
3.4 Adjust Tone.....	15
3.5 Adjust Sharpness .....	16
3.6 Select Scene .....	16
3.7 Set Palettes.....	17
3.8 Set Display Mode .....	19
3.9 Adjust Digital Zoom .....	19

# Multi-spectrum Binocular User Manual

---

3.10 Set Picture in Picture Mode.....	20
3.11 Flat Field Correction .....	21
3.12 Correct Defective Pixel .....	21
3.13 Set Infrared Light .....	22
3.14 Zoom Pro .....	22
<b>Chapter 4 Measure Distance with Laser .....</b>	<b>24</b>
<b>Chapter 5 General Settings .....</b>	<b>26</b>
5.1 Set OSD.....	26
5.2 Set Brand Logo.....	26
5.3 Burning Prevention .....	26
5.4 Capture and Video .....	27
5.4.1 Capture Picture .....	27
5.4.2 Set Audio.....	27
5.4.3 Record Video .....	27
5.4.4 View Local Files .....	28
5.5 Hot Tracking .....	29
5.6 Export Files .....	29
5.6.1 Export Files via HIKMICRO Sight.....	29
5.6.2 Export Files via PC.....	31
5.7 Direction Display .....	31
5.7.1 Calibrate Compass.....	32
5.7.2 Magnetic Declination Correction.....	33
5.8 Geographic Location Display .....	34
<b>Chapter 6 System Settings .....</b>	<b>35</b>
6.1 Adjust Date .....	35
6.2 Synchronize Time .....	35
6.3 Set Language.....	35
6.4 Set Unit .....	36
6.5 View Device Information.....	36

# Multi-spectrum Binocular User Manual

---

6.6 Restore Device.....	36
<b>Chapter 7 Frequently Asked Questions .....</b>	<b>38</b>
7.1 Why does the charge indicator flash improperly?.....	38
7.2 Why is the power indicator off? .....	38
7.3 The image is not clear, how to adjust it?.....	38
7.4 Capturing or recording fails. What's the problem? .....	38
7.5 Why the PC cannot identify the device? .....	38
<b>Safety Instruction .....</b>	<b>39</b>
<b>Legal Information .....</b>	<b>42</b>
<b>Regulatory Information .....</b>	<b>44</b>

# Chapter 1 Overview

## 1.1 Brief Description

HIKMICRO HABROK series is a powerful and innovative handheld thermal and digital day & night vision multi-spectrum binocular. It adopts a 12  $\mu\text{m}$  infrared thermal detector with high thermal sensitivity up to NETD < 20 mK, 2560  $\times$  1440 low illumination optical detector with built-in adjustable IR illuminator, and a precise built-in laser rangefinder up to 1000 m measuring distance. It offers excellent image quality in true living color or thermal during day and night observation in adverse weather conditions with up to 1800 m detection range. The device can be mainly applied in forest & field hunting, birding, animal searching, adventuring, and rescuing scenario.

## 1.2 Function

### Zoom Pro

Zoom Pro, an advanced zoomed image processing algorithm, ensures maximum image optimization under digital zoom.

### Smart IR

The smart IR function helps to view targets clearly in dark environment.

### GPS

Equipped with satellite positioning modules, the device can be located with GPS system.

### Compass

The device can detect the azimuth angle and elevation angle and show the direction information on the screen.

### Distance Measurement

Built-in laser range finder provides an accurate distance between the target and the observation position.

### Auto Screen Off

Auto screen off function allows the device to enter standby mode/wake up through angle changes. The function darkens the screen to save energy and increase battery time.

### App Connection

The device can capture snapshots, record videos, and set parameters by HIKMICRO Sight app after being connected to your phone via hotspot.

## 1.3 Appearance

The appearance may vary according to different models. Please take the actual product for reference.

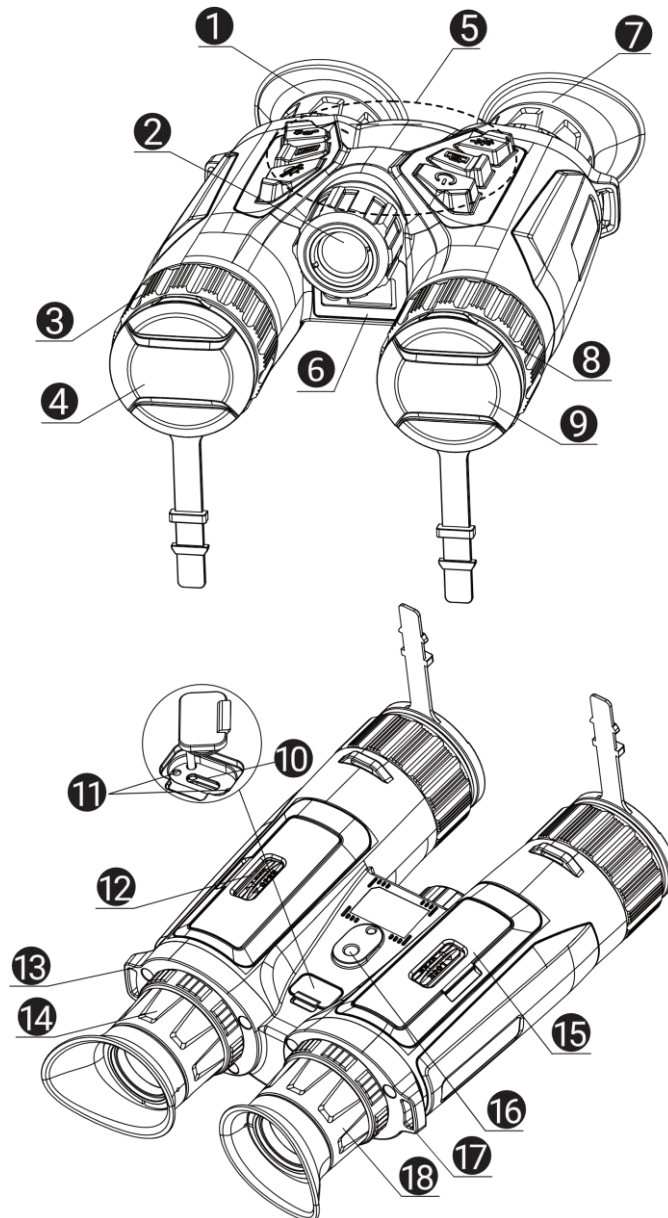







Figure 1-1 Appearance

## Multi-spectrum Binocular User Manual

**Table 1-1 Components**

No.	Description	Function
1 & 7	Eyepiece	The piece placed closest to the eye to view the target. Adjust the interpupillary distance by moving the eyepieces farther or closer to each other.
2	Infrared Light	Helps to view target clearly in the dark environment.
3 & 8	Focus Ring	Adjusts focus to obtain clear targets.
4	Thermal Lens	For thermal imaging.
5	Buttons	To set functions and parameters.
6	Laser Rangefinder	Measures the distance to the target with laser.
9	Optical Lens	For optical imaging.
10	Type-C Interface	To connect the device to power supply or transmit data with a type-C cable.
11	Charging Status Indicator	<ul style="list-style-type: none"> <li>● Flashing Red &amp; Green: Error occurred.</li> <li>● Solid Red: Charging.</li> <li>● Solid Green: Fully charged.</li> </ul>
12 & 15	Battery Compartment	For holding the battery.
13 & 17.	Neck Strap Attachment Point	Mounts the neck strap.
14 & 18	Diopter Adjustment Ring	Adjusts the dioptic setting.
16	Tripod Mount	Mounts the tripod.

**Table 1-2 Button Description**

Icon	Button	Function
	Power	<ul style="list-style-type: none"> <li>● Press: Standby mode/Wake up device.</li> <li>● Hold: Power on/off.</li> </ul>
	Capture	<ul style="list-style-type: none"> <li>● Press: Capture snapshots.</li> <li>● Hold: Start/Stop recording videos.</li> </ul>
	Measure	<ul style="list-style-type: none"> <li>● Press: Turn on/off laser ranging.</li> <li>● Hold: Correct non-uniformity of display (FFC).</li> </ul>
	Mode	Non-Menu Mode: <ul style="list-style-type: none"> <li>● Press: Switch palettes.</li> <li>● Hold: Switch day/night/auto mode.</li> </ul> Menu Mode: Press to move up.
	Menu	Non-Menu Mode: Press to enter the menu. Menu Mode: <ul style="list-style-type: none"> <li>● Press: Confirm/Set parameters.</li> </ul>

## Multi-spectrum Binocular User Manual

---

Icon	Button	Function
		<ul style="list-style-type: none"><li>• Hold: Save and exit menu.</li></ul>
	Zoom	Non-Menu Mode: <ul style="list-style-type: none"><li>• Press: Switch digital zoom.</li><li>• Hold: Turn on/off PIP (Picture-in-Picture).</li></ul> Menu Mode: Press to move down.

---

### Note

- The power indicator stays solid red when the device is on.
  - When the auto screen off function is enabled, if you press  to enter standby mode, you can also tilt or rotate the device to wake up the device. Refer to *Auto Screen Off* for detailed operation.
-



## Chapter 2 Preparation

Take out the device and accessories. Check them with the packaging list to confirm device and accessories are included and available for use. Read the user manual to learn the usage methods and cautions.

### 2.1 Install Battery

#### 2.1.1 Battery Instruction

- Remove the battery if the device is not used for a long time.
- The external rechargeable battery type is 18650, and the battery size should be 19 mm × 70 mm. The rated voltage is 3.6 VDC, and the battery capacity is 3200 mAh.
- Charge the battery for more than 5 hours before first use.
- To ensure better conductivity, if the battery compartment cover gets dirty, use a clean cloth to wipe the thread.

#### 2.1.2 Battery Installation

Insert the battery into the battery compartment.

##### Steps

1. Unlock and open the battery compartment cover.

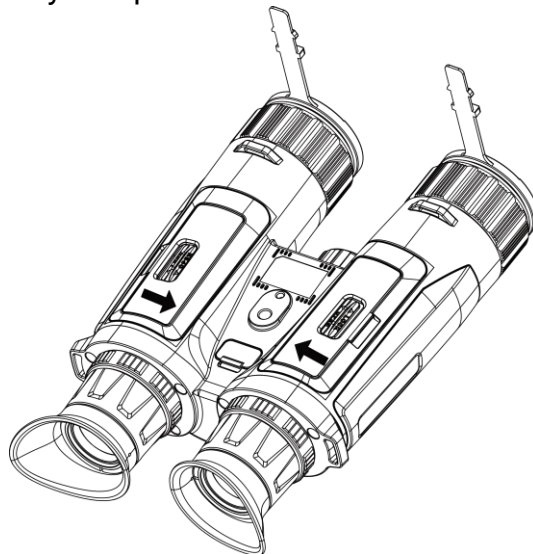
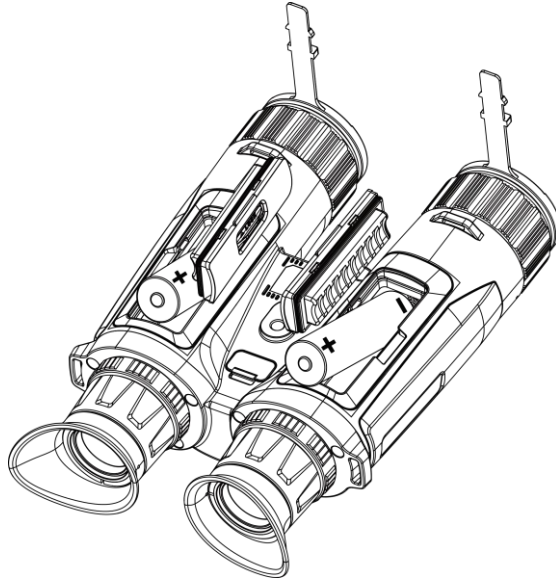

Figure 2-1 Open the Cover

2. Insert batteries into the battery compartment as the positive and negative marks indicate.



**Figure 2-2 Install the Battery**

3. Close the battery compartment cover and lock it.

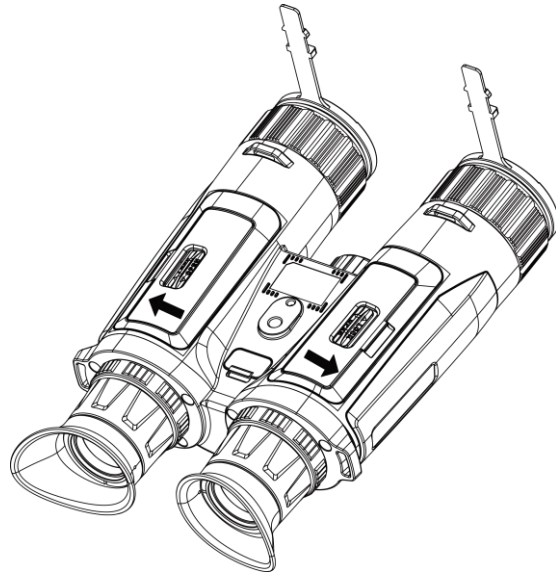

**Figure 2-3 Close the Cover**

## 2.2 Cable Connection

Connect the device and power adapter with a type-C cable to charge the device.

Alternatively, connect the device and PC to export files.

### Steps

1. Lift the type-C interface cover.
2. Connect the device and power adapter with a type-C cable to charge the device.

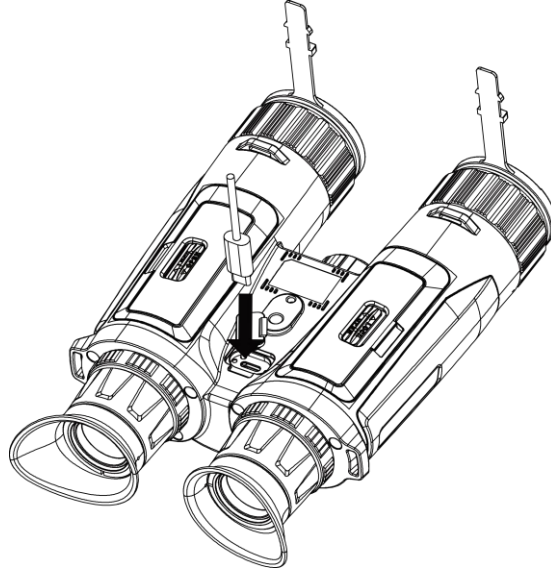

Figure 2-4 Cable Connection

---

### Note

- Please charge the device after the battery is installed in the battery compartment of the device.
  - The charging temperature should be from 0 °C to 45 °C (32 °F to 113 °F).
  - You can use battery charger to charge the battery.
- 

## 2.3 Mount Neck Strap

### Steps

1. Thread one end of the neck strap through a neck strap attachment point.

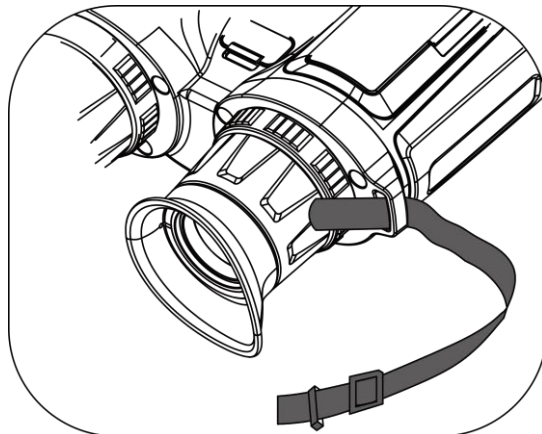

**Figure 2-5 Thread Neck Strap through Attachment Point**

2. Thread the neck strap through the strap buckle and fasten the neck strap, as is shown in the picture.

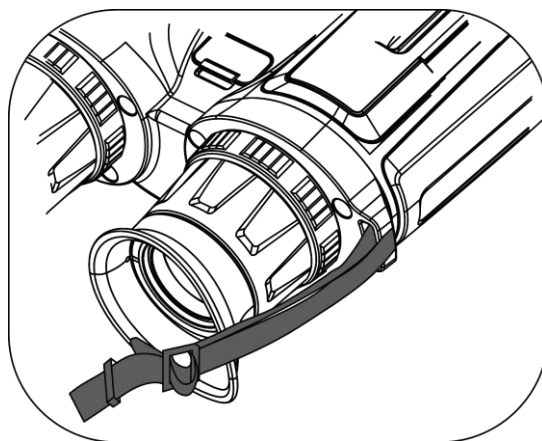

**Figure 2-6 Thread Neck Strap through Strap Buckle**

3. Thread the neck strap through the strap keeper.

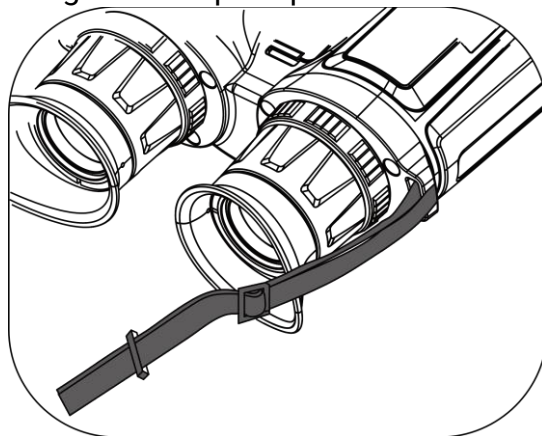

**Figure 2-7 Thread Neck Strap through Strap Keeper**

4. Repeat above steps to finish mounting.

5. Adjust the length of neck strap as needed.

## 2.4 Mount Tripod Adapter

### Steps

1. Insert the location column (1) to the location point (2).

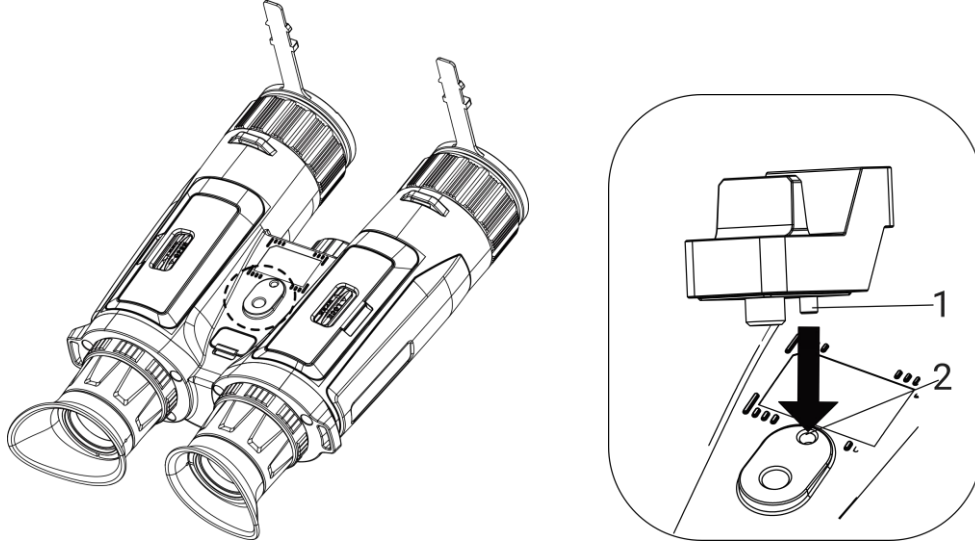

Figure 2-8 Insert the Column

2. Rotate the tripod adapter screw clockwise to fix the tripod adapter.

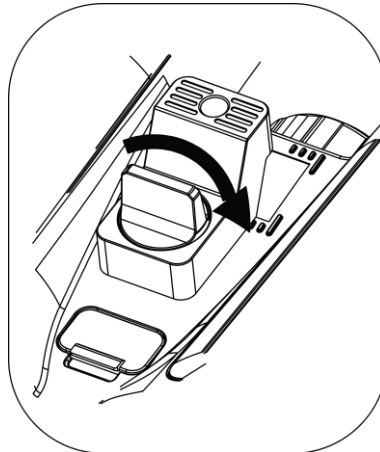



Figure 2-9 Rotate the Screw

## 2.5 Power On/Off

### Power On

When the device is connected to cable or the battery is enough, hold  to power on the

device.

## Power Off

When the device is turned on, hold  to power off the device.

---











### Note

- Power-off countdown will appear when you power off the device. You can press any key to interrupt the countdown and cancel the power-off.
  - Automatic low battery power-off cannot be canceled.
- 



## Auto Power Off

You can set the auto power off time for your device.

### Steps

1. Press  to show the menu.
  2. Go to  **Advanced Settings**, and select  **General Settings**.
  3. Press  or  to select , and press  to enter the configuration interface.
  4. Press  or  to select the auto power off time as required, and press  to confirm.
  5. Hold  to save and exit.
- 





### Note



- See the battery icon for the battery status.  means the battery is fully charged,  means that the battery is low, and  means the battery charging is abnormal.
  - When the low power note shows, charge the battery.
  - The auto power off countdown will start again when the device reenters the standby mode or the device is restarted.
- 

## 2.6 Auto Screen Off

Auto screen off function darkens the screen to save energy and increase battery time. However, the device stays on and you can view the live view on HIKMICRO Sight app when connecting the device to the app.

### Steps

1. Enable auto screen off.
    - 1). Press  to show the menu.
    - 2). Go to  **Advanced Settings**, and press  or  to select .
-

- 3). Press  to enable auto screen off.
  - 4). Hold  to save settings and exit.
2. Enter standby mode.
- You can do one of the following methods to enter the standby mode when the display is turned on:
- Tilt the device downwards from 70° to 90°.
  - Rotate the device horizontally from 75° to 90°.
  - Keep the device still and do not move it for 5 minutes.
3. Wake up device.
- You can do one of the following methods to wake up the device when the display is turned off:
- Tilt the device downwards from 0° to 60° or upwards from 0° to 90°.
  - Rotate the device horizontally from 0° to 75°.
  - Press  to wake up the device.

## 2.7 Menu Description

In the live view interface, press  to show the menu.

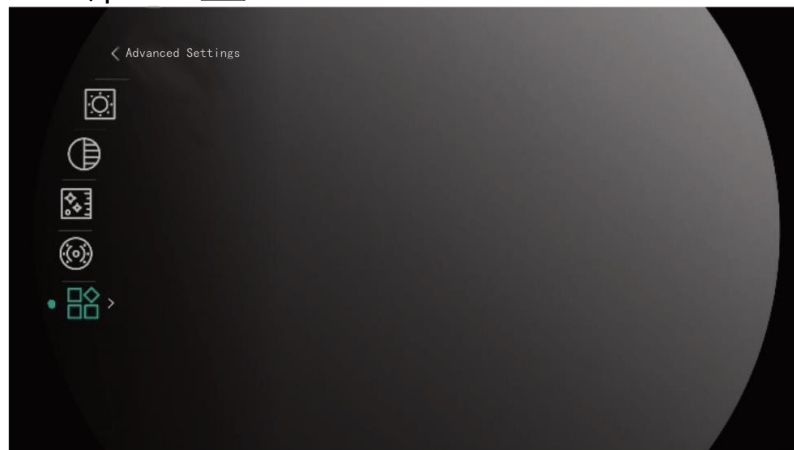





Figure 2-10 Menu Description

- Press  to move the cursor up.
- Press  to move the cursor down.
- Press  to confirm and hold it to exit the menu.

## 2.8 App Connection

Connect the device to the HIKMICRO Sight app via hotspot, then you can capture picture,

record video, or configure parameters on your phone.

### Steps

1. Search the HIKMICRO Sight on App Store (iOS System) or Google Play™ (Android System) to download it, or scan the QR code to download and install the app.



Android System



iOS System

2. Press to show the menu.
3. Go to **Advanced Settings**, and press or to select .
4. Press to enter the setting interface.
5. Press or to select **Hotspot**. The hotspot function is enabled.
6. Turn on the WLAN of your phone and connect to the hotspot.
  - Hotspot Name: HIKMICRO\_Serial No.
  - Hotspot Password: Serial No.
7. Open the app and connect your phone with the device. You can view the interface of device on your phone.

---

### Note

- The device cannot connect to the app if you enter wrong password several times. Refer to **Restore Device** to reset the device, and connect the app again.
  - The device should be activated for the first use. The default password must be changed after the activation.
- 

## 2.9 Firmware Status

### 2.9.1 Check Firmware Status

#### Steps

1. Open the HIKMICRO Sight and connect your device to the app.
2. Check if there is an upgrade prompt on the device management interface. If there is no upgrade prompt, the firmware is the latest version. Otherwise, the firmware is not the latest version.



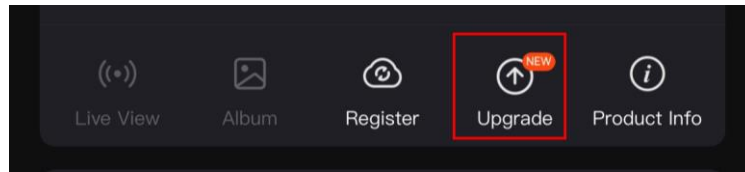

**Figure 2-11 Check Firmware Status**

3. (Optional) If the firmware is not the latest version, upgrade the device. See *Upgrade Device*.

## 2.9.2 Upgrade Device

### Upgrade Device via HIKMICRO Sight

#### Before You Start

Install HIKMICRO Sight on your phone and connect your device to the app.

#### Steps

1. Tap the upgrade prompt to enter the firmware upgrade interface.
2. Tap **Upgrade** to start upgrade.

---

#### Note

The upgrading operation may vary due to app updates. Please take the actual app version for reference.

---

### Upgrade Device via PC

#### Before You Start

Please get the upgrade package first.

#### Steps

1. Connect the device to your PC with cable.
2. Open the detected disk, copy the upgrade file and paste it to the root directory of the device.
3. Disconnect the device from your PC.
4. Reboot the device.

#### Result

The device upgrades automatically. The upgrading process will be displayed in the interface.

## Chapter 3 Image Settings

You can set palettes, brightness, scenes, FFC (flat field correction), and DPC (defective pixel correction) to display the better image effect.

### 3.1 Adjust Device

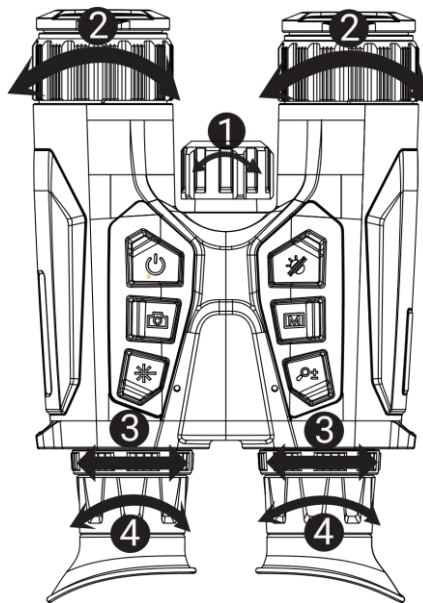

Figure 3-1 Adjust Device

#### ① Adjust Infrared Light

Slightly rotate to adjust the beam angle of the infrared light. The broader the beam angle is, the more spread-out but less intense the light will be.

#### ② Adjust Focus

Slightly rotate the focus ring to adjust the focus of the objective lens.

---

#### Note

DO NOT touch the lens directly with your finger, or place any sharp objects near them.

---

#### ③ Adjust Interpupillary Distance

Adjust the interpupillary distance by moving the eyepieces farther or closer to each other.

#### ④ Adjust Diopter

Make sure the eyepiece covers your eye and aim at the target. Adjust the diopter adjustment ring until the OSD text or image is clear.

## Note









When adjusting diopter, DO NOT touch the surface of lens to avoid smearing the lens.

---

## 3.2 Adjust Brightness









You can adjust the display brightness of the screen in the menu.

### Steps

1. Press  to show the menu.
2. Press  or  to select  and press  to confirm.
3. Press  or  to adjust display brightness.
4. Hold  to save settings and exit.









## 3.3 Adjust Contrast

### Steps

1. Press  to show the menu.
2. Press  or  to select  and press  to confirm.
3. Press  or  to adjust contrast.
4. Hold  to save settings and exit.

## 3.4 Adjust Tone

### Steps

1. Press  to show the menu.
2. Go to  **Advanced Settings**, and press  or  to select .
3. Press  to confirm, and press  or  to select a tone. **Warm** and **Cold** can be selected.
4. Hold  to save and exit.

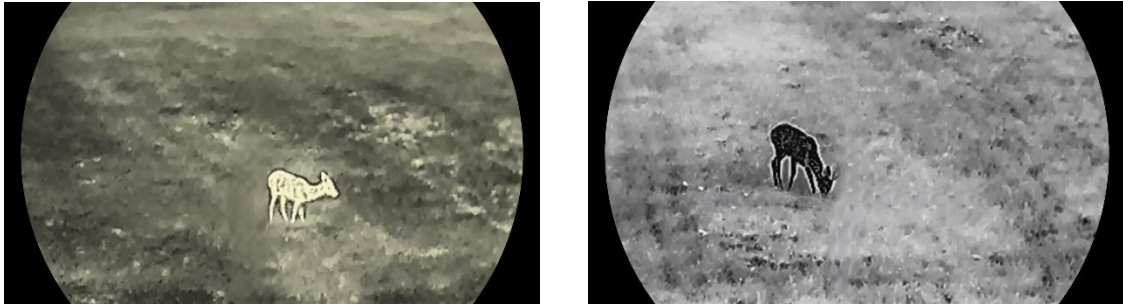











Figure 3-2 Tone Comparison

## 3.5 Adjust Sharpness

### Steps

1. Press  to show the menu.
2. Go to  **Advanced Settings**, and press  or  to select .
3. Press  to confirm, and press  or  to adjust sharpness.
4. Hold  to save and exit.

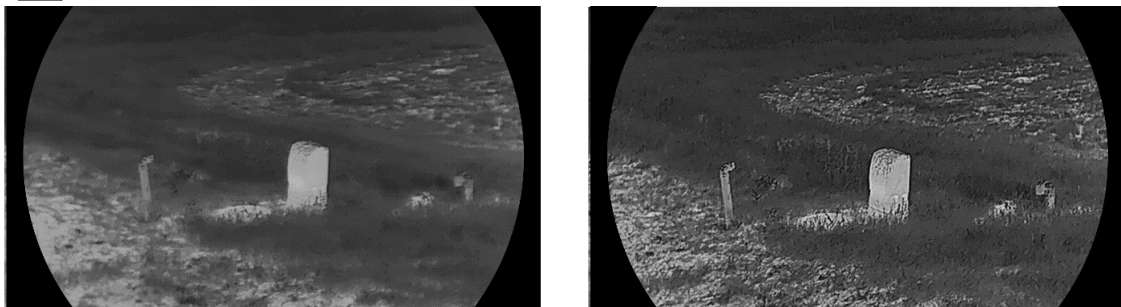











Figure 3-3 Sharpness Adjustment Comparison

## 3.6 Select Scene

You can select proper scene according to actual using scene to improve the display effect.

### Steps









1. Press  to show the menu.
2. Go to  **Advanced Settings**, and press  or  to select .
3. Press  to enter the setting interface.
4. Press  or  to switch scene.
  - **Recognition:** Recognition refers to recognition mode and is recommended in normal scene.

- **Jungle:** Jungle refers to jungle mode and is recommended in hunting environment.
5. Hold  to save settings and exit.

### 3.7 Set Palettes

You can select different palettes to display the same scene in different effects.

#### Steps



1. Press  to show the menu.
2. Go to  **Advanced Settings**, and press  or  to select .
3. Press  to go to the palettes interface.
4. Press  or  to select the palettes required, and press  to enable them.

---

#### Note

At least one palette should be enabled.

---

5. Hold  to save the settings and exit.
6. Press  in live view interface to switch the selected palettes.

#### Optical

The image of optical channel is displayed in this mode.



#### White Hot

The hot part is light-colored in view. The higher the temperature is, the lighter the color is.



**Black Hot**

The hot part is black-colored in view. The higher the temperature is, the darker the color is.



**Red Hot**

The hot part is red-colored in view. The higher the temperature is, the redder the color is.



**Fusion**

From high temperature to low temperature, the image is colored in from white, yellow, red, pink to purple.





### 3.8 Set Display Mode

You can select different display modes in different scenes.

#### Steps

Hold  in live view interface to switch display modes. Day, night, and auto modes are selectable.

- : Day Mode: You can use this mode at daytime and in bright environment. In day mode, the IR light is off automatically.
- : Night Mode: You can use this mode at nights. In night mode, the IR light is on automatically.
- : Auto Mode: The day mode and night mode switch automatically according to the ambient brightness.



Day Mode



Night Mode

Figure 3-4 Day/Night Mode

### 3.9 Adjust Digital Zoom

You can zoom in and out the image by using this function.

#### Steps

Press  in the live view interface, the digital zoom ratio switches between 1x, 2x, 4x

and 8×.

### Note

- When switching the digital zoom ratio, the top-left corner of interface displays the actual magnification (Actual Magnification = Lens Optical Magnification × Digital Zoom Ratio). For example, the lens optical magnification is 2.8× and the digital zoom ratio is 2×, and the actual magnification is 5.6×.
  - The zoom ratio may vary according to different models. Please take the actual product for reference.
- 

## 3.10 Set Picture in Picture Mode

### Steps



Hold  in live view mode to enable PIP, and hold  again to exit PIP. The image center is displayed in upper middle of the interface.



Figure 3-4 Set Picture in Picture Mode

### Note













- If the PIP function is enabled, only the PIP view zooms when adjusting the digital zoom ratio.
  - If the PIP function is enabled in thermal mode, the PIP view only switches between current palette and optical mode; if the PIP function is enabled in optical mode, the PIP view switches among the selected palettes and optical mode.
-



## 3.11 Flat Field Correction

This function can correct non-uniformity of display.

### Steps

1. Press  to show the menu.
2. Go to  **Advanced Settings**, and select  **Function Settings**.
3. Press  or  to select , and press  to enter the configuration interface.
4. Press  or  to switch FFC mode.
  - **Manual FFC:** Hold  in the live view to correct the non-uniformity of display.
  - **Auto FFC:** The device performs FFC automatically according to the set schedule when switching on the camera.
  - **External:** Cover the lens cover, then hold  in the live view to correct the non-uniformity of display.
5. Hold  to save the settings and exit.

---

### Note













The countdown will start before the device performs FFC automatically.

---

## 3.12 Correct Defective Pixel

The device can correct the defective pixels on the screen which are not performed as expected.

### Steps

1. Press  to show the menu.
2. Go to  **Advanced Settings**, and select  **Function Settings**.
3. Press  or  to select , and press  to enter DPC configuration interface.
4. Press  to select **X** or **Y Axis**. If you select **X** axis, the cursor moves left and right; if you select **Y** axis, the cursor moves up and down.
5. Press  or  to set the coordinates until the cursor reaches the defective pixel.
6. Press  twice to correct the dead pixel.
7. Hold  to save the settings and exit.

---

### Note

- The selected defective pixel can be magnified and displayed on the bottom right of the interface.
- If the screen OSD blocks the defective pixel, move the cursor to reach the defective







pixel, then the device performs mirror display automatically as shown in the figures below.

---

### 3.13 Set Infrared Light

The infrared light helps to view targets clearly in dark environment. The infrared light only works in night mode, auto mode or when the environment is dark. In other modes, the infrared light does not take effect.

#### Steps

1. Press  to show the menu.
2. Press  or  to select  and press  to confirm.
3. Press  or  to select the light level or set smart IR.

#### Smart IR

Image overexposure may occur in too bright environment. The smart IR function helps to adjust the overexposed images by controlling infrared light intensity, so as to improve the image effect in night mode and dark environment.

4. Hold  to save settings and exit.
- 

#### Note







Infrared light cannot be turned on if the battery is low.

---

### 3.14 Zoom Pro

Zoom Pro refers to zoomed image detail enhancement. When you turn on this function, the details of zoomed live view image will be enhanced.

#### Steps

1. Press  to show the menu.
2. Press  or  to select .
3. Press  to enable the function.
4. Hold  to save settings and exit.

#### Result

The details of the zoomed live view image will be enhanced.

---

### Note

- If the PIP function is enabled, Zoom Pro is only enabled in the PIP view.
  - Zoom Pro cannot be enabled when device battery is low.
-









## Chapter 4 Measure Distance with Laser

The device can detect the distance between the target and the observation position with laser.

### Before You Start

When measuring the distance, keep the hand and the position steady. Otherwise, the accuracy may be affected.

### Steps



1. Press  to show the menu.
2. Go to  **Advanced Settings**, and press  or  to select .
3. Press  to go to the measurement interface.
4. Press  or  to select a continuous laser ranging mode. Press  to confirm.

---

### Note



The device can measure the distance continuously, and the measurement duration can be selected. The measurement result will be refreshed every 1 s.

---

5. Hold  to save the settings and return to the live view interface.
6. Aim the cursor at the target and press  to measure the target distance.

---

### Note

- Press  in the live view interface to enable laser ranging, and press  again in the live view interface to turn off laser ranging.
  - Laser ranging cannot be enabled when device battery is low.
- 

### Result

The distance measurement result is displayed at the upper right of the image.

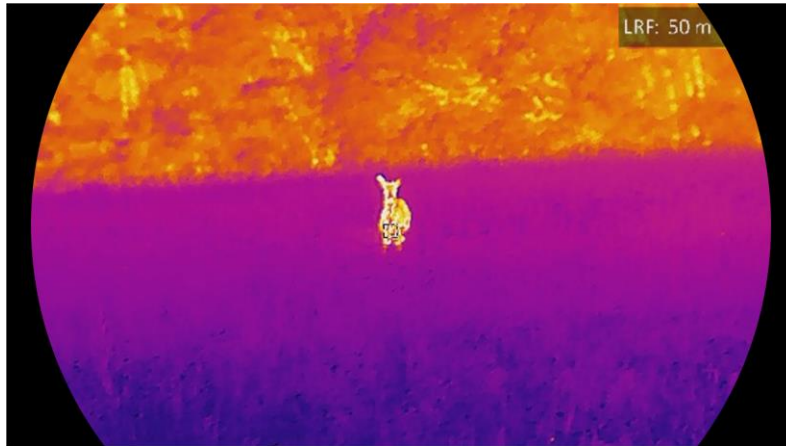

Figure 4-1 Laser Ranging Result

---

 **Caution**

The laser radiation emitted from the device can cause eye injuries, burning of skin or inflammable substances. Before enabling the laser ranging function, make sure no human or inflammable substances are in front of the laser lens.











---

## Chapter 5 General Settings

### 5.1 Set OSD

This function can display or hide the OSD information on the live view interface.

#### Steps

1. Press  to show the menu.
2. Go to  **Advanced Settings**, and select  **Function Settings**.
3. Press  or  to select **OSD**, and press  to enter OSD setting interface.
4. Press  or  to select the **Time, Date, or OSD**, and press  to turn on or turn off the selected OSD information.
5. Hold  to save and exit.

---

#### Note









If you turn off **OSD**, all OSD information on the live view will not be displayed.

---

### 5.2 Set Brand Logo

You can add brand logo to the live view interface, snapshots, and videos.

#### Steps

1. Press  to show the menu.
2. Go to  **Advanced Settings**, and select  **Function Settings**.
3. Press  or  to select .
4. Press  to enable **Brand Logo**.
5. Hold  to save the settings and exit.









#### Result

The brand logo is displayed at the bottom left of the image.

### 5.3 Burning Prevention

Avoid direct sunlight and enable the burning prevention function to reduce the risk of sensor damage from the heat.

## Steps

1. Press  to show the menu.
2. Go to  **Advanced Settings**, and select  **Function Settings**.
3. Press  or  to select .
4. Press  to enable or disable the function.
5. Hold  to save settings and exit.

## 5.4 Capture and Video

### 5.4.1 Capture Picture

In the live view interface, press  to capture picture.

---

#### Note

When capturing succeeds, the image freezes for 1 second and a prompt shows on the display.







For exporting pictures, refer to *Export Files*.

---

### 5.4.2 Set Audio

If you turn on the audio function, the sound will be recorded with the video. When there is too loud noise in the video, you can turn off this function.

#### Steps

1. Press  to show the menu.
2. Go to  **Advanced Settings**, and press  or  to select .
3. Press  to enable or disable this function.
4. Hold  to save settings and exit.

### 5.4.3 Record Video

#### Steps

1. In the live view interface, hold  to start recording.



**Figure 5-1 Start Recording**

The left image displays the information of recording time.

2. Hold  again to stop recording.





### What to do next

For exporting videos, refer to *Export Files*.

## 5.4.4 View Local Files

Captured images and recorded videos are automatically stored in the device, and you can view the files in local albums.

### Steps







1. Press  to go to the menu.
2. Go to  **Advanced Settings**, and press  or  to select .

---

### Note

The albums are automatically created and named by year + month. The local pictures and videos of a certain month are stored in the corresponding album. For example, the pictures and videos of August in 2023 are saved in the album named 202308.



---



3. Press  or  to select the album storing the files, and press  to enter the selected album.
  4. Press  or  to select a file to view.
  5. Press  to view the selected file and relevant information.
- 

### Note

- Files are arranged in chronological order, with the most recent at the top. If you fails to
-









find the most recently taken snapshots or videos, please check the time and date settings of your device. When you are viewing files, you can switch to other files by pressing  or .

- When you are viewing videos, you can press  to play or stop the video.
  - For deleting an album or a file, you can hold  to call the dialogue box, and delete the album or file according to the prompt.
- 

## 5.5 Hot Tracking

The device can detect the highest temperature spot in the scene and mark it on display.

### Steps

1. Press  to show the menu.
2. Go to  **Advanced Settings**, and press  or  to select .
3. Press  to mark the spot of highest temperature.

### Result



When the function is enabled,  displays in the spot of highest temperature. When the scene changes, the  moves.



Figure 5-2 Hot Tracking

## 5.6 Export Files

### 5.6.1 Export Files via HIKMICRO Sight

You can access device albums and export files to your phone via HIKMICRO Sight.

## Before You Start

Install HIKMICRO Sight on your mobile phone.

### Steps

1. Open HIKMICRO Sight and connect your device to the app. See *App Connection*.
2. Tap **Media** to access device albums.

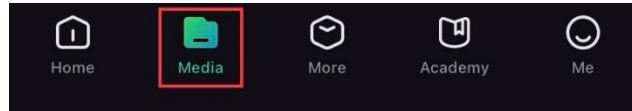

Figure 5-3 Access Device Albums

3. Tap **Local** or **Device** to view the photos and videos.
  - **Local**: You can view the files captured on app.
  - **Device**: You can view the files of the current device.

---

### Note

The photos or videos may not show in **Device**. Please pull down to refresh the page.

---

4. Tap to select a file, and tap **Download** to export the file to your local phone albums.



Figure 5-4 Export Files

---

### Note

- Go to **Me** -> **About** -> **User Manual** on the app to see more detailed operations.
- You can also access device albums by tapping bottom left icon in the live view interface.

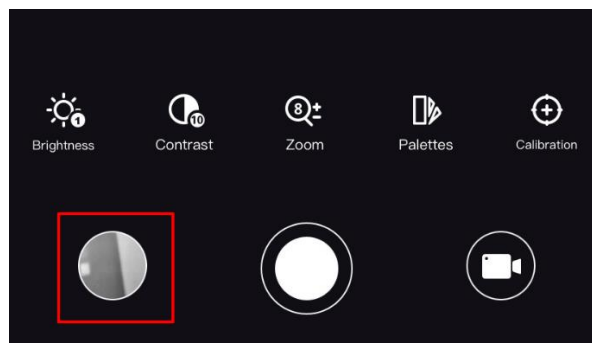

Figure 5-5 Access Device Albums

- The exporting operation may vary due to app updates. Please take the actual app version for reference.
- 

### 5.6.2 Export Files via PC

This function is used to export recorded videos and captured pictures.

#### Steps

1. Connect the device and PC with cable.
- 

#### Note

Make sure the device is turned on when connecting the cable.

---

2. Open computer disk and select the disk of device. Go to the DCIM folder and find the folder named after the capture year and month. For example, if you capture a picture or record a video on June 2023, go to **DCIM -> 202306** to find the picture or video.
  3. Select and copy the files to PC.
  4. Disconnect the device from your PC.
- 







#### Note

- The device displays images when you connect it to PC. But functions such as recording, capturing and hotspot are disabled.
  - When you connect the device to PC for the first time, it installs the drive program automatically.
- 

## 5.7 Direction Display

Equipped with a compass, the device can display its direction on the live image, captured images, and recorded videos.

#### Steps

1. Press  to show the menu.
  2. Go to  **Advanced Settings**, and select  **Function Settings**.
  3. Press  or  to select , and select **Compass**, then press  to enable the function.
  4. Follow the pop-up instructions to calibrate the compass. See *Calibrate Compass* for more information.
-

## Result

After successful calibration, you can see the azimuth angle and elevation angle displayed on the screen. It is recommended to read the information when you lay the device horizontally.

To increase the direction accuracy, you can set the magnetic declination correction. See *Magnetic Declination Correction* for instructions.



## 5.7.1 Calibrate Compass

Compass calibration is a must for correction direction display. You need to calibrate the compass when you enable the function for the first time, or when the compass is magnetically interfered.



Figure 5-6 Compass Interference

### Steps

1. Call the calibration guide by the following ways.
  - When you enable compass for the first time, the compass calibration guide pops up.
  - When the compass information appears in red, select  in the menu and press  to restart calibrating compass.
2. Follow the screen instructions to move and rotate the device.

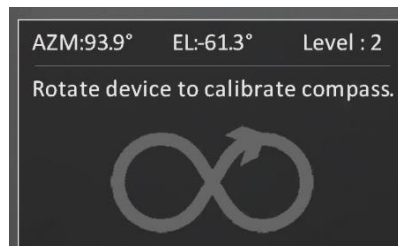

Figure 5-7 Calibrate Compass

---

### Note

- During calibration, keep moving and rotating the device to make sure that the device faces every possible directions.
  - **Calibration Level** indicates the validity of calibration. Higher level means more accurate compass reading. Calibration succeeds when **Calibration Level** turns to 3.
- 

3. Stop moving the device when calibration success message pops up.

## Result

The direction information is displayed on the live view interface.

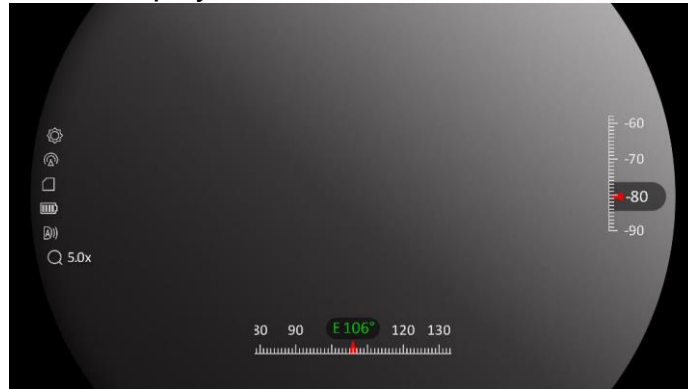

Figure 5-8 Direction Display

## 5.7.2 Magnetic Declination Correction

Magnetic declination is the angle variation between magnetic north and true north. Adding the magnetic declination to the compass increases the accuracy of direction reading.

### Steps

1. After the compass is calibrated, go to the compass setting interface, and press or to select **Magnetic Declination**.
2. Press to enter the setting interface, and press or to select **Quick Correction** or **Manual Correction**.
  - In quick correction, the device displays the current declination to magnetic north. Point screen center to true north and press .
  - In manual correction, press to select the operational symbol or number, and press or to add or subtract the declination of device location.

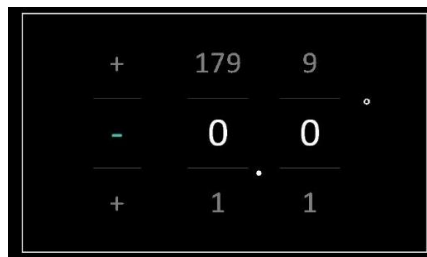

Figure 5-9 Manual Correction

3. Hold to save and exit.

## Note

It is recommended to check the local magnetic declination information on the authorized website before manually correcting the magnetic declination. The eastern magnetic declination is indicated with a positive mark (+), and the western declination is indicated with a negative mark (-).

---

## 5.8 Geographic Location Display

---

### Note

- The satellite module is not able to receive signals when the device is indoor. Place the device in an empty outdoor space to receive signals.
  - In an outdoor space, wait for a moment for the device to display its location.
- 

Equipped with satellite positioning modules, the device is able to display the longitude and latitude, as well as the sea level altitude of the device on the live image, captured images, and recorded videos.

### Steps







1. Press  to show the menu.
2. Go to  **Advanced Settings**, and select  **Function Settings**.
3. Press  or  to select , and press  to enable GPS. You can see the location displayed at the lower right corner of the screen.



Figure 5-9 Device Location Display

---

### Note

If the location information displays the error code "100", it indicates the signal is weak or no signal. Please move to the empty outdoor space to try again.

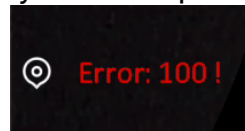













Figure 5-10 Location Display Error Code.

---

## Chapter 6 System Settings

















### 6.1 Adjust Date

#### Steps

1. Press  to show the menu.
2. Go to  **Advanced Settings**, and select  **General Settings**.
3. Press  or  to select .
4. Press  to enter the configuration interface.
5. Press  to select the year, month, or day, and press  or  to change the number.
6. Hold  to save settings and exit.

### 6.2 Synchronize Time

#### Steps











1. Press  to show the menu.
2. Go to  **Advanced Settings**, and select  **General Settings**.
3. Press  or  to select .
4. Press  to enter the configuration interface.
5. Press  or  to switch the clock system. 24-hour and 12-hour clock are selectable. If you select 12-hour clock, press , and then press  or  to select AM or PM.
6. Press  to select the hour or minute, and press  or  to change the number.
7. Hold  to save settings and exit.

### 6.3 Set Language

You can select the device language in this function.

#### Steps











1. Press  to show the menu.

2. Go to  **Advanced Settings**, and select  **General Settings**.
3. Press  or  to select .
4. Press  to enter the language configuration interface.
5. Press  or  to select the language as required, and press  to confirm.
6. Hold  to save settings and exit.

## 6.4 Set Unit









You can switch the unit for distance measurement.

### Steps

1. Press  to show the menu.
2. Go to  **Advanced Settings**, and select  **General Settings**.
3. Press  or  to select .
4. Press  to enter the unit setting interface. Press  or  to select the unit as required.
5. Hold  to save settings and exit.







## 6.5 View Device Information

### Steps

1. Press  to show the menu.
2. Go to  **Advanced Settings**, and select  **General Settings**.
3. Press  or  to select .
4. Press  to confirm. You can view the device information such as version and serial No.
5. Hold  to save settings and exit.

## 6.6 Restore Device

### Steps

1. Press  to show the menu.
2. Go to  **Advanced Settings**, and select  **General Settings**.
3. Press  or  to select .



4. Press  to restore the device to defaults according to the prompt.

## Chapter 7 Frequently Asked Questions

### 7.1 Why does the charge indicator flash improperly?

Check the following items.

- Check whether the device is charged with standard power adapter and the charging temperature is above 0 °C (32 °F).
- The device is equipped with built-in charging protection module. Charge the device in power off status.

### 7.2 Why is the power indicator off?

Check whether the device is off-battery. Check the indicator after charging the device for 5 minutes.

### 7.3 The image is not clear, how to adjust it?

Adjust the diopter adjustment ring or focus ring until the image is clear. Refer to *Adjust Device*.

### 7.4 Capturing or recording fails. What's the problem?

Check the following items.

- Whether the device is connected to your PC. Capturing or recording is disabled in this status.
- Whether the storage space is full.
- Whether the device is low-battery.

### 7.5 Why the PC cannot identify the device?

Check the following items.

- Whether the device is connected to your PC with supplied USB cable.
- If you use other USB cables, make sure the cable length is no longer than 1 m.

# Safety Instruction



These instructions are intended to ensure that user can use the product correctly to avoid danger or property loss.

## Laws and Regulations

Use of the product must be in strict compliance with the local electrical safety regulations.

## Symbol Conventions

The symbols that may be found in this document are defined as follows.

Symbol	Description
 <b>Danger</b>	Indicates a hazardous situation which, if not avoided, will or could result in death or serious injury.
 <b>Caution</b>	Indicates a potentially hazardous situation which, if not avoided, could result in equipment damage, data loss, performance degradation, or unexpected results.
 <b>Note</b>	Provides additional information to emphasize or supplement important points of the main text.

## Transportation

- Keep the device in original or similar packaging while transporting it.
- Keep all wrappers after unpacking them for future use. In case of any failure occurred, you need to return the device to the factory with the original wrapper.
- Transportation without the original wrapper may result in damage on the device and the company shall not take any responsibilities.
- Do not drop the product or subject it to physical shock. Keep the device away from magnetic interference.

## Power Supply

- Input voltage should meet the Limited Power Source (5 VDC, 2 A) according to the IEC61010-1 standard. Please refer to technical specifications for detailed information.
- Make sure the plug is properly connected to the power socket.
- DO NOT connect multiple devices to one power adapter, to avoid over-heating or fire hazards caused by overload.

## Battery

- The external rechargeable battery type is 18650, and the battery size should be 19 mm × 70 mm. The rated voltage and capacity are 3.6 VDC/3200 mAh.

- For long-term storage of the battery, make sure it is fully charged every half year to ensure the battery quality. Otherwise, damage may occur.
- Use the battery provided by qualified manufacturer. Refer to the product specification for detailed battery requirements.
- CAUTION: Risk of explosion if the battery is replaced by an incorrect type.
- Improper replacement of the battery with an incorrect type may defeat a safeguard (for example, in the case of some lithium battery types).
- Do not dispose of the battery into fire or a hot oven, or mechanically crush or cut the battery, which may result in an explosion.
- Do not leave the battery in an extremely high temperature surrounding environment, which may result in an explosion or the leakage of flammable liquid or gas.
- Do not subject the battery to extremely low air pressure, which may result in an explosion or the leakage of flammable liquid or gas.
- Dispose of used batteries according to the instructions.

### Using Environment

- Make sure the running environment meets the requirement of the device. The operating temperature shall be -30 °C to 55 °C (-22 °F to 131 °F), and the operating humidity shall be from 5% to 95%.
- DO NOT expose the device to high electromagnetic radiation or dusty environments.
- DO NOT aim the lens at the sun or any other bright light.
- Place the device in a dry and well-ventilated environment.

### Maintenance

- If the product does not work properly, please contact your dealer or the nearest service center. We shall not assume any responsibility for problems caused by unauthorized repair or maintenance.
- Wipe the device gently with a clean cloth and a small quantity of ethanol, if necessary.
- If the equipment is used in a manner not specified by the manufacturer, the protection provided by the device may be impaired.
- Clean the lens with soft and dry cloth or wiping paper to avoid scratching it.

### Emergency

- If smoke, odor, or noise arises from the device, immediately turn off the power, unplug the power cable, and contact the service center.

### Laser

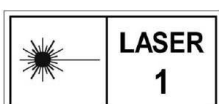

When any laser equipment is in use, make sure that the device lens is not exposed to the laser beam, or it may burn out. The laser radiation emitted from the device can cause eye injuries, burning of skin or inflammable substances. Before enabling the laser ranging function, make sure no

human or inflammable substances are in front of the laser lens. Do not place the device where minors can fetch it. The wavelength is 905 nm, and the max. power output is less than 1.15 mW. According to IEC 60825-1:2014, this laser product is classified as Class 1 laser product.

### **Manufacture Address**

Room 313, Unit B, Building 2, 399 Danfeng Road, Xixing Subdistrict, Binjiang District,  
Hangzhou, Zhejiang 310052, China  
Hangzhou Microimage Software Co., Ltd.

COMPLIANCE NOTICE: The thermal series products might be subject to export controls in various countries or regions, including without limitation, the United States, European Union, United Kingdom and/or other member countries of the Wassenaar Arrangement. Please consult your professional legal or compliance expert or local government authorities for any necessary export license requirements if you intend to transfer, export, re-export the thermal series products between different countries.

## Legal Information

©2023 Hangzhou Microimage Software Co., Ltd. All rights reserved.

### About this Manual

The Manual includes instructions for using and managing the Product. Pictures, charts, images and all other information hereinafter are for description and explanation only. The information contained in the Manual is subject to change, without notice, due to firmware updates or other reasons. Please find the latest version of this Manual at the HIKMICRO website ([www.hikmicrotech.com](http://www.hikmicrotech.com)).

Please use this Manual with the guidance and assistance of professionals trained in supporting the Product.

### Trademarks Acknowledgement



and other HIKMICRO's trademarks and logos are the properties of HIKMICRO in various jurisdictions.

Other trademarks and logos mentioned are the properties of their respective owners.

### LEGAL DISCLAIMER

TO THE MAXIMUM EXTENT PERMITTED BY APPLICABLE LAW, THIS MANUAL AND THE PRODUCT DESCRIBED, WITH ITS HARDWARE, SOFTWARE AND FIRMWARE, ARE PROVIDED "AS IS" AND "WITH ALL FAULTS AND ERRORS". HIKMICRO MAKES NO WARRANTIES, EXPRESS OR IMPLIED, INCLUDING WITHOUT LIMITATION, MERCHANTABILITY, SATISFACTORY QUALITY, OR FITNESS FOR A PARTICULAR PURPOSE. THE USE OF THE PRODUCT BY YOU IS AT YOUR OWN RISK. IN NO EVENT WILL HIKMICRO BE LIABLE TO YOU FOR ANY SPECIAL, CONSEQUENTIAL, INCIDENTAL, OR INDIRECT DAMAGES, INCLUDING, AMONG OTHERS, DAMAGES FOR LOSS OF BUSINESS PROFITS, BUSINESS INTERRUPTION, OR LOSS OF DATA, CORRUPTION OF SYSTEMS, OR LOSS OF DOCUMENTATION, WHETHER BASED ON BREACH OF CONTRACT, TORT (INCLUDING NEGLIGENCE), PRODUCT LIABILITY, OR OTHERWISE, IN CONNECTION WITH THE USE OF THE PRODUCT, EVEN IF HIKMICRO HAS BEEN ADVISED OF THE POSSIBILITY OF SUCH DAMAGES OR LOSS.

YOU ACKNOWLEDGE THAT THE NATURE OF THE INTERNET PROVIDES FOR INHERENT SECURITY RISKS, AND HIKMICRO SHALL NOT TAKE ANY RESPONSIBILITIES FOR ABNORMAL OPERATION, PRIVACY LEAKAGE OR OTHER DAMAGES RESULTING FROM CYBER-ATTACK, HACKER ATTACK, VIRUS INFECTION, OR OTHER INTERNET SECURITY RISKS; HOWEVER, HIKMICRO WILL PROVIDE TIMELY TECHNICAL SUPPORT IF REQUIRED. YOU AGREE TO USE THIS PRODUCT IN COMPLIANCE WITH ALL APPLICABLE LAWS, AND YOU ARE SOLELY RESPONSIBLE FOR ENSURING THAT YOUR USE CONFORMS TO THE APPLICABLE LAW. ESPECIALLY, YOU ARE RESPONSIBLE, FOR USING THIS PRODUCT IN A MANNER THAT DOES NOT INFRINGE ON THE RIGHTS OF THIRD PARTIES, INCLUDING

WITHOUT LIMITATION, RIGHTS OF PUBLICITY, INTELLECTUAL PROPERTY RIGHTS, OR DATA PROTECTION AND OTHER PRIVACY RIGHTS. YOU SHALL NOT USE THIS PRODUCT FOR ILLEGAL HUNTING ANIMALS, INVASION OF PRIVACY OR ANY OTHER PURPOSE WHICH IS ILLEGAL OR DETRIMENTAL TO THE PUBLIC INTEREST. YOU SHALL NOT USE THIS PRODUCT FOR ANY PROHIBITED END-USES, INCLUDING THE DEVELOPMENT OR PRODUCTION OF WEAPONS OF MASS DESTRUCTION, THE DEVELOPMENT OR PRODUCTION OF CHEMICAL OR BIOLOGICAL WEAPONS, ANY ACTIVITIES IN THE CONTEXT RELATED TO ANY NUCLEAR EXPLOSIVE OR UNSAFE NUCLEAR FUEL-CYCLE, OR IN SUPPORT OF HUMAN RIGHTS ABUSES.

IN THE EVENT OF ANY CONFLICTS BETWEEN THIS MANUAL AND THE APPLICABLE LAW, THE LATTER PREVAILS.

## Regulatory Information

---

These clauses apply only to the products bearing the corresponding mark or information.

---

### EU Compliance Statement



This product and - if applicable - the supplied accessories too are marked with "CE" and comply therefore with the applicable harmonized European standards listed under the Directive 2014/30/EU (EMCD), Directive 2014/35/EU (LVD), Directive 2011/65/EU (RoHS), Directive 2014/53/EU.

Hereby, Hangzhou Microimage Software Co., Ltd. declares that this device (refer to the label) is in compliance with Directive 2014/53/EU. The full text of the EU declaration of conformity is available at the following internet address:

<https://www.hikmicrotech.com/en/support/download-center/declaration-of-conformity/>

#### Frequency Bands and Power (for CE)

The frequency bands and transmitting power (radiated and/or conducted) nominal limits applicable to the following radio equipment are as follows:

Wi-Fi 2.4 GHz (2.4 GHz to 2.4835 GHz), 20 dBm

For the device without a supplied power adapter, use the power adapter provided by a qualified manufacturer. Refer to the product specification for detailed power requirements.

For the device without a supplied battery, use the battery provided by a qualified manufacturer. Refer to the product specification for detailed battery requirements.



Directive 2012/19/EU (WEEE Directive): Products marked with this symbol cannot be disposed of as unsorted municipal waste in the European Union. For proper recycling, return this product to your local supplier upon the purchase of equivalent new equipment, or dispose of it at designated collection points. For more information see: [www.recyclethis.info](http://www.recyclethis.info).



Directive 2006/66/EC and its amendment 2013/56/EU (Battery Directive): This product contains a battery that cannot be disposed of as unsorted municipal waste in the European Union. See the product



documentation for specific battery information. The battery is marked with this symbol, which may include lettering to indicate cadmium (Cd), lead (Pb), or mercury (Hg). For proper recycling, return the battery to your supplier or to a designated collection point. For more information see: [www.recyclethis.info](http://www.recyclethis.info).

### Industry Canada ICES-003 Compliance

This device meets the CAN ICES-003 (B)/NMB-003(B) standards requirements. This device complies with Industry Canada license-exempt RSS standard(s). Operation is subject to the following two conditions:

- (1) this device may not cause interference, and
- (2) this device must accept any interference, including interference that may cause undesired operation of the device.

This equipment complies with IC RSS-102 radiation exposure limits set forth for an uncontrolled environment.

### Conformité Industrie Canada ICES-003

Cet appareil répond aux exigences des normes CAN ICES-003 (B)/NMB-003 (B). Cet appareil est conforme aux normes RSS exemptes de licence d'Industrie Canada. Son fonctionnement est soumis aux deux conditions suivantes :

- (1) cet appareil ne doit pas causer d'interférences, et
- (2) cet appareil doit accepter toute interférence reçue, notamment les interférences susceptibles d'occasionner un fonctionnement indésirable de l'appareil.

Cet appareil est conforme aux limites d'exposition au rayonnement IC RSS-102 établies pour un environnement non contrôlé.

### KC

B급 기기: 이 기기는 가정용(B급) 전자파적합기기로서 주로 가정에서 사용하는 것을 목적으로 하며, 모든 지역에서 사용할 수 있습니다.

### INFORMATIONEN FÜR PRIVATE HAUSHALTE

#### 1. Getrennte Erfassung von Altgeräten:

Elektro- und Elektronikgeräte, die zu Abfall geworden sind, werden als Altgeräte bezeichnet. Besitzer von Altgeräten haben diese einer vom unsortierten Siedlungsabfall getrennten Erfassung zuzuführen. Altgeräte gehören insbesondere nicht in den Hausmüll, sondern in spezielle Sammel- und Rückgabesysteme.

#### 2. Batterien und Akkus sowie Lampen:

Besitzer von Altgeräten haben Altbatterien und Altakkumulatoren, die nicht vom Altgerät umschlossen sind, die zerstörungsfrei aus dem Altgerät entnommen werden können, im Regelfall vor der Abgabe an einer Erfassungsstelle vom Altgerät zu trennen. Dies gilt nicht,

soweit Altgeräte einer Vorbereitung zur Wiederverwendung unter Beteiligung eines öffentlich-rechtlichen Entsorgungsträgers zugeführt werden.

### **3. Möglichkeiten der Rückgabe von Altgeräten:**

Besitzer von Altgeräten aus privaten Haushalten können diese bei den Sammelstellen der öffentlich-rechtlichen Entsorgungsträger oder bei den von Herstellern oder Vertriebern im Sinne des ElektroG eingerichteten Rücknahmestellen unentgeltlich abgeben.

Rücknahmepflichtig sind Geschäfte mit einer Verkaufsfläche von mindestens 400 m<sup>2</sup> für Elektro- und Elektronikgeräte sowie diejenigen Lebensmittelgeschäfte mit einer Gesamtverkaufsfläche von mindestens 800 m<sup>2</sup>, die mehrmals pro Jahr oder dauerhaft Elektro- und Elektronikgeräte anbieten und auf dem Markt bereitstellen. Dies gilt auch bei Vertrieb unter Verwendung von Fernkommunikationsmitteln, wenn die Lager- und Versandflächen für Elektro- und Elektronikgeräte mindestens 400 m<sup>2</sup> betragen oder die gesamten Lager- und Versandflächen mindestens 800 m<sup>2</sup> betragen. Vertrieber haben die Rücknahme grundsätzlich durch geeignete Rückgabemöglichkeiten in zumutbarer Entfernung zum jeweiligen Endnutzer zu gewährleisten. Die Möglichkeit der unentgeltlichen Rückgabe eines Altgerätes besteht bei rücknahmepflichtigen Vertriebern unter anderem dann, wenn ein neues gleichartiges Gerät, das im Wesentlichen die gleichen Funktionen erfüllt, an einen Endnutzer abgegeben wird.

### **4. Datenschutz-Hinweis:**

Altgeräte enthalten häufig sensible personenbezogene Daten. Dies gilt insbesondere für Geräte der Informations- und Telekommunikationstechnik wie Computer und Smartphones. Bitte beachten Sie in Ihrem eigenen Interesse, dass für die Löschung der Daten auf den zu entsorgenden Altgeräten jeder Endnutzer selbst verantwortlich ist.

### **5. Bedeutung des Symbols „durchgestrichene Mülltonne“:**



Das auf Elektro- und Elektronikgeräten regelmäßig abgebildete Symbol einer durchgestrichenen Mülltonne weist darauf hin, dass das jeweilige Gerät am Ende seiner Lebensdauer getrennt vom unsortierten Siedlungsabfall zu erfassen ist.



**HIKMICRO**

See the World in a New Way



Facebook: HIKMICRO Outdoor Instagram: hikmicro\_outdoor

YouTube: HIKMICRO Outdoor

LinkedIn: HIKMICRO

Web: [www.hikmicrotech.com](http://www.hikmicrotech.com)

E-mail: [support@hikmicrotech.com](mailto:support@hikmicrotech.com)

UD35597B