



TH50Z 2.0

Thermal Image Scope

With a 2.2x to 34.6x large magnification realized by the 384 detector @20 mK, HIKMICRO THUNDER ZOOM TH50Z 2.0 is the perfect match for both wooded and open field areas. Besides, a F0.8 large aperture can strengthen your viewing ability of objects; an extended operation time can guarantee a non-stop game.

Key Features

- 384 × 288 resolution with 12 μm detector
- High sensitivity thermal module NETD < 20 mK (25°C, F# = 1.0)
- Dual FOV of 25 mm (F0.8) & 50 mm (F1.0) objective lenses
- 1024 × 768 resolution 0.39-inch OLED display
- Up to 6.5 hours of continuous operation
- Replaceable and rechargeable Li-ion battery packs
- High shock resistance up to 1000 g/0.4 ms
- Detection range up to 2600 m

Specification

THERMAL MODULE	
IMAGE SENSOR	Uncooled Focal Plane Arrays
MAX. RESOLUTION	384 × 288
FRAME RATE	50 Hz
PIXEL INTERVAL	12 μm
NETD	Less than 20 mK (25°C, F# = 1.0)
LENS (FOCAL LENGTH)	25 mm, F0.8 AND 50 mm, F1.0
FOCUS MODE	Optical Zoom, Focus Ring
DETECTION RANGE	1200 m/2600 m
MIN. FOCUSING DISTANCE	25 mm: 4 m/50 mm: 10 m
MAGNIFICATION	2.2x to 17.4x/4.3x to 34.6x (8x)
FIELD OF VIEW(H × V), DEGREES/M @100 M	10.5° × 7.9°/18.4 m × 13.8 m; 5.3° × 4°/9.2 m × 6.9 m
IMAGE DISPLAY	
DISPLAY	1024 × 768, 0.39 inch, OLED
PALETTES	Black Hot, White Hot, Red Hot, Fusion
FFC (FLAT FIELD CORRECTION) MODE	Auto, Manual, External Correction
EXIT PUPIL	6 mm
EYE RELIEF	45 mm
DIOPTER (RANGE)	-5 D to 5 D
BRIGHTNESS ADJUSTMENT	Yes
TONE ADJUSTMENT	Cold, Warm
SYSTEM	
RECORD VIDEO	On-board Video Recording
CAPTURE SNAPSHOT	Yes
STANDBY MODE	Yes
STORAGE	Built-in EMMC (16 GB)
PIP	Yes
DPC	Yes
HOTSPOT	Yes
HOT TRACK	Yes

DISTANCE MEASUREMENT	Yes
AUDIO RECORDING	Yes
RECOIL-ACTIVATION RECORDING	Yes
MAX. RECOIL	1000 g/0.4 ms
ZEROING PROFILES	5
POWER SUPPLY	
BATTERY TYPE	Replaceable and Rechargeable Li-ion Battery
BATTERY OPERATING TIME	≥ 6.5 h (25°C, with hotspot off)
TYPE-C POWER SUPPLY	5 V DC, 2 A Supports External Power Supply
GENERAL	
PROTECTION LEVEL	IP67
DIMENSION	241.2 mm × 67.0 mm × 73.4 mm
WEIGHT	750 g without battery
WORKING TEMPERATURE	-30°C to +55°C (-22°F to 131°F)

Available Model

HM-TR53-2550S1G/W-TH50Z 2.0

Dimension

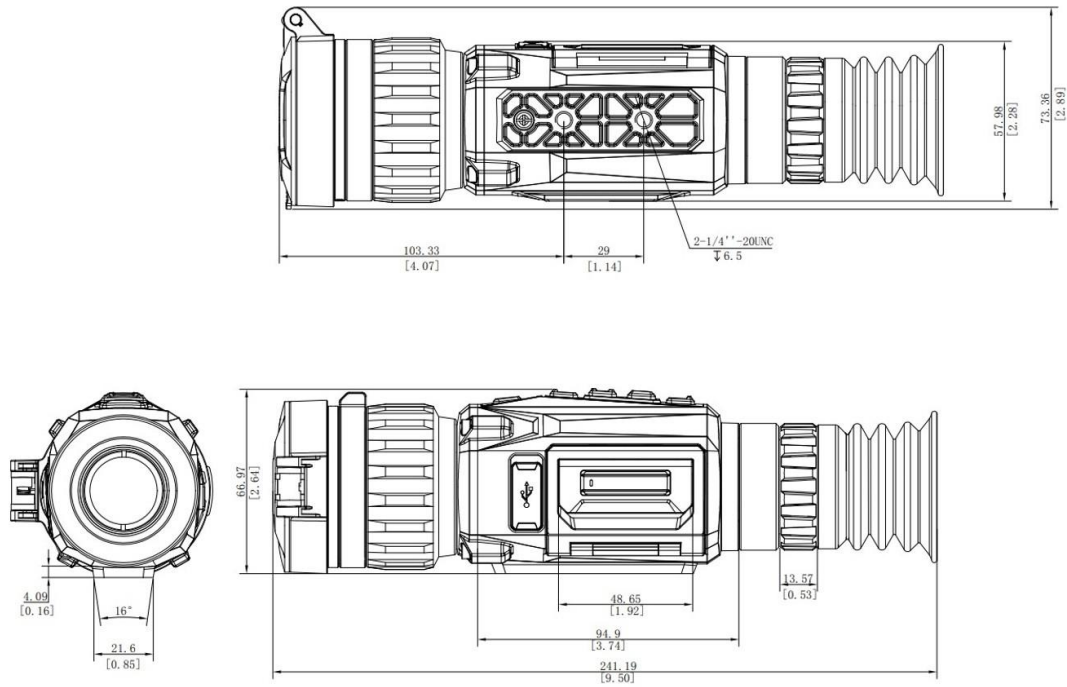

Unit: mm

Accessories

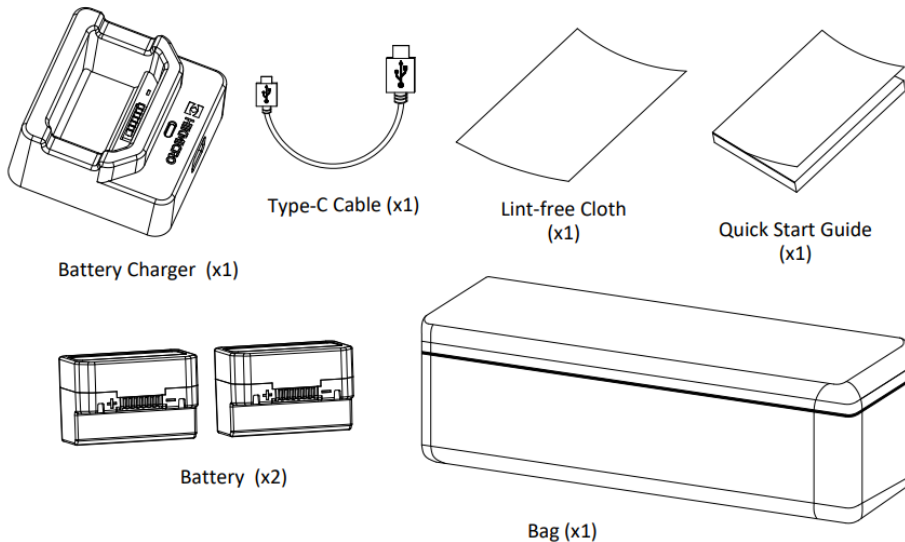

COMPLIANCE NOTICE: The thermal series products might be subject to export controls in various countries or regions, including without limitation, the United States, European Union, United Kingdom and/or other member countries of the Wassenaar Arrangement. Please consult your professional legal or compliance expert or local government authorities for any necessary export license requirements if you intend to transfer, export, re-export the thermal series products between different countries.



HIKMICRO SIGHT



HIKMICRO Outdoor hikmicro_outdoor HIKMICRO Outdoor HIKMICRO info@hikmicrotech.com <http://hikmicrotech.com/en>

Room 313, Unit B, Building 2, 399 Danfeng Road, Xixing Subdistrict, Binjiang District, Hangzhou, Zhejiang
@hangzhou microimage software co.,Ltd .2020 | data subject to change without notice!