









No	Adet • Qty.	Parça • Parts	No	Adet • Qty.	Parça • Parts
A	4 x	 (M6x50 Pul Başlı C.) (M6x50 Bolts)	C	2x	 (5mm Burç) (5mm Bush)
B	4x	 (10mm Burç) (10mm Bush)	D	4x	 (M8 Pul) (M8 Flake)

Gerekli Aletler • Required Tools

 (Yıldız Tornavida) (Star Screwdriver)	 (4 Alyan) • (#4 Allen)
 (3 Alyan) • (#3 Allen)	 (10mm Lokma Anahtar) (10mm Socket Key)

Montaj Talimatları

1- Aşama 1'de gösterilen klipslerin ortalarındaki deliklere hafifçe bastırın ve çıkartın.

Mounting Instructions

1- Lightly press the holes in the middle of the clips as shown in Step 1 and remove them.

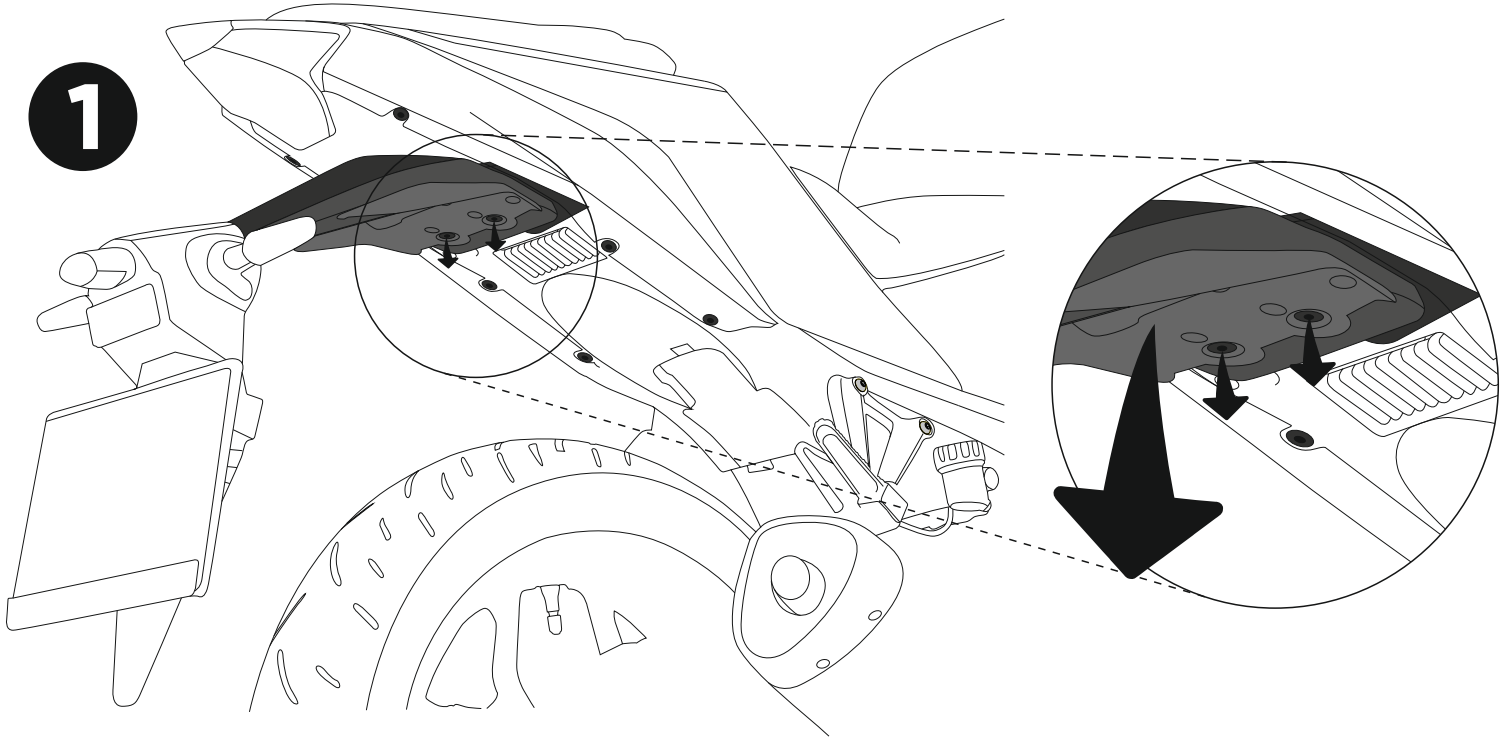

Montaj Talimatları

- 2-** Motosikletinizi aşama 2'deki gibi konumlandırın.
3- Aşama 3'te gösterilen cıvataları çıkartın.

Mounting Instructions

- 2-** Position your motorcycle as shown in step 2.
3- Remove the bolts as shown in step 3.

2

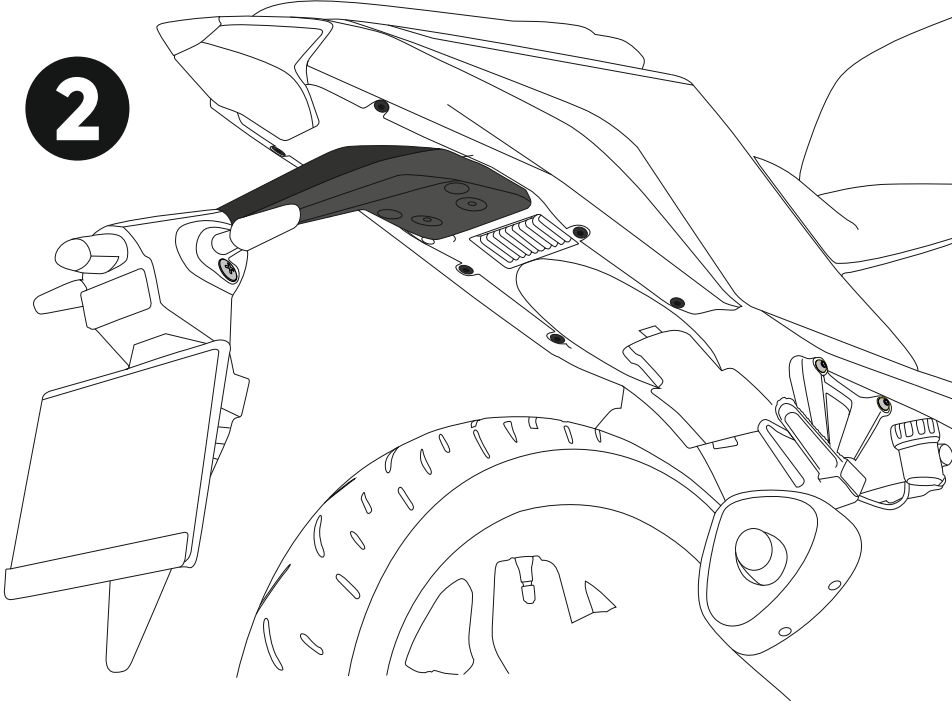

3

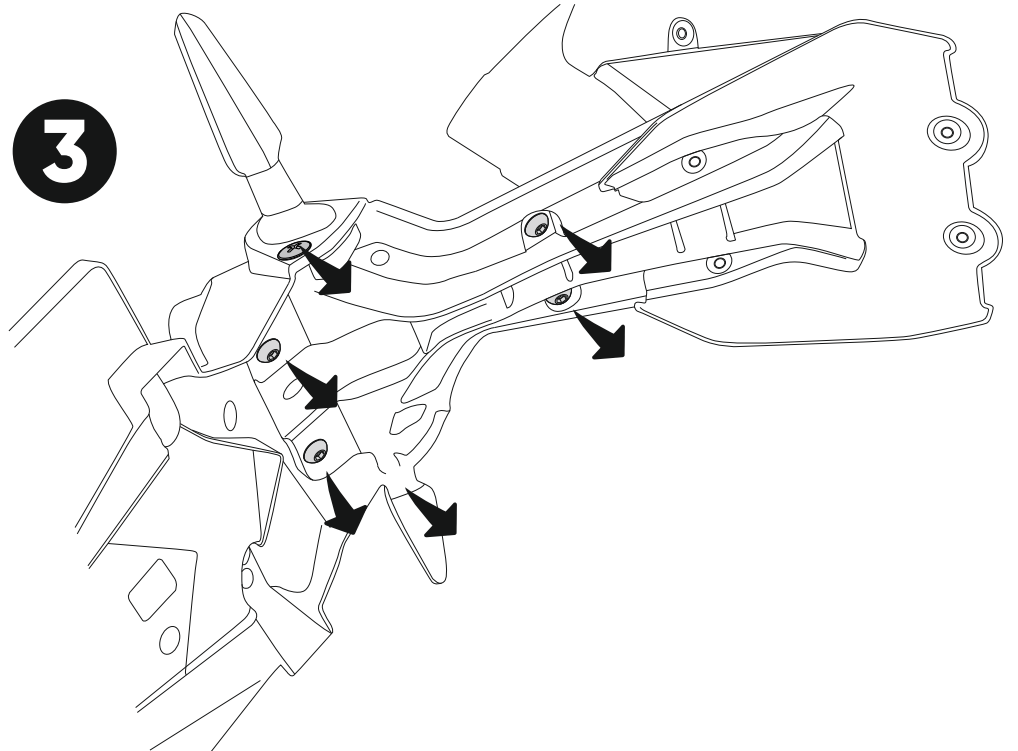

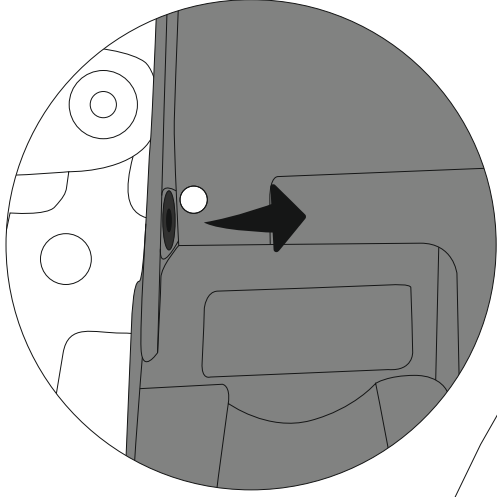

4

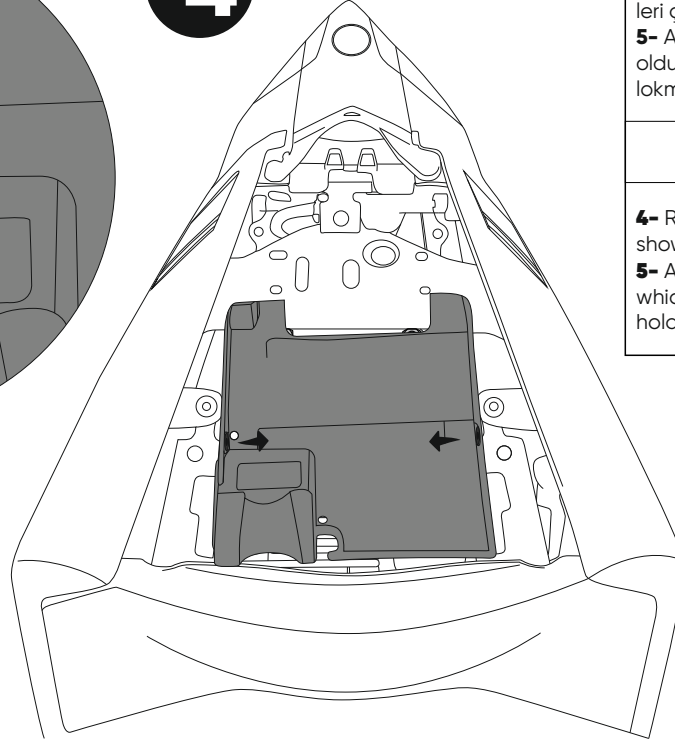

Montaj Talimatları

4- Aşama 4'te gösterildiği gibi selenin altında bulunan kapağı çıkartmak için gösterilen klipsleri çıkartın.

5- Aşama 5'te gösterildiği gibi kuyruğun bağlı olduğu 4 civatayı sele içerisinden somunlarını lokma yardımıyla tutarak çıkartın.

Mounting Instructions

4- Remove the clips of under seat cover as shown in step 4.

5- As shown in step 5, remove the 4 bolts to which the tail is attached from the seat by holding the nuts with the help of a socket.

5

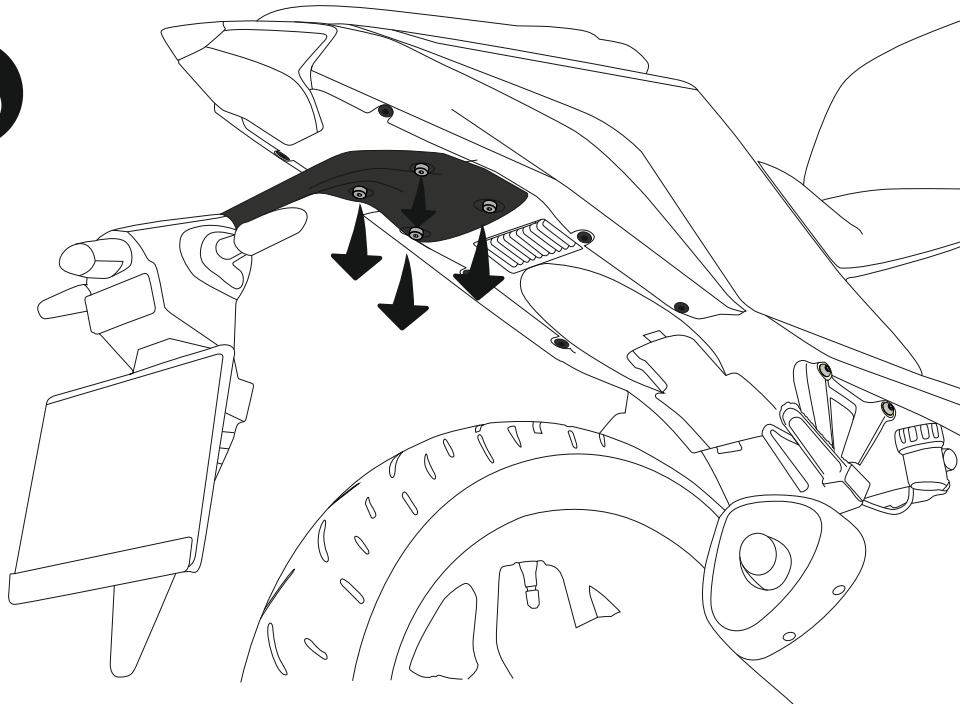

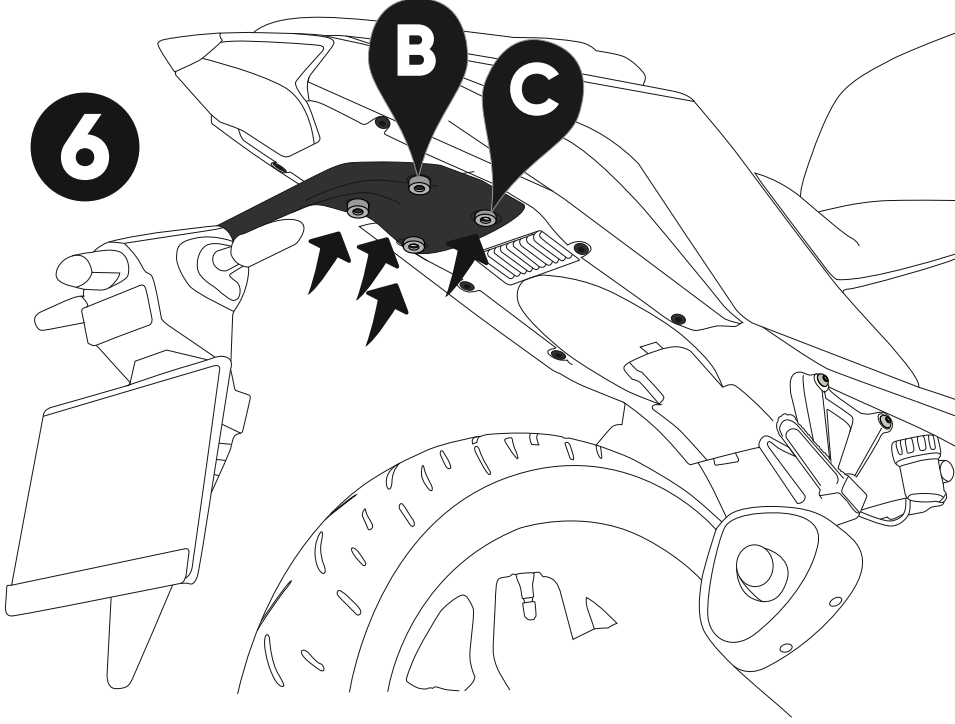

Montaj Talimatları

6- Aşama 6'de gösterildiği gibi burçları yerleştirin.
7- Aşama 7'de gösterildiği gibi çanta demirini yerleştirin ve altından M8 pul ile birlikte cıvatalayın. Artçı basamaklarını gösterildiği gibi çıkartın.

Mounting Instructions

6- Place bushings as shown in step 6.
7- Place bag iron as shown in step 7 and bolt it with M8 flake underneath. Remove the passenger step as shown.

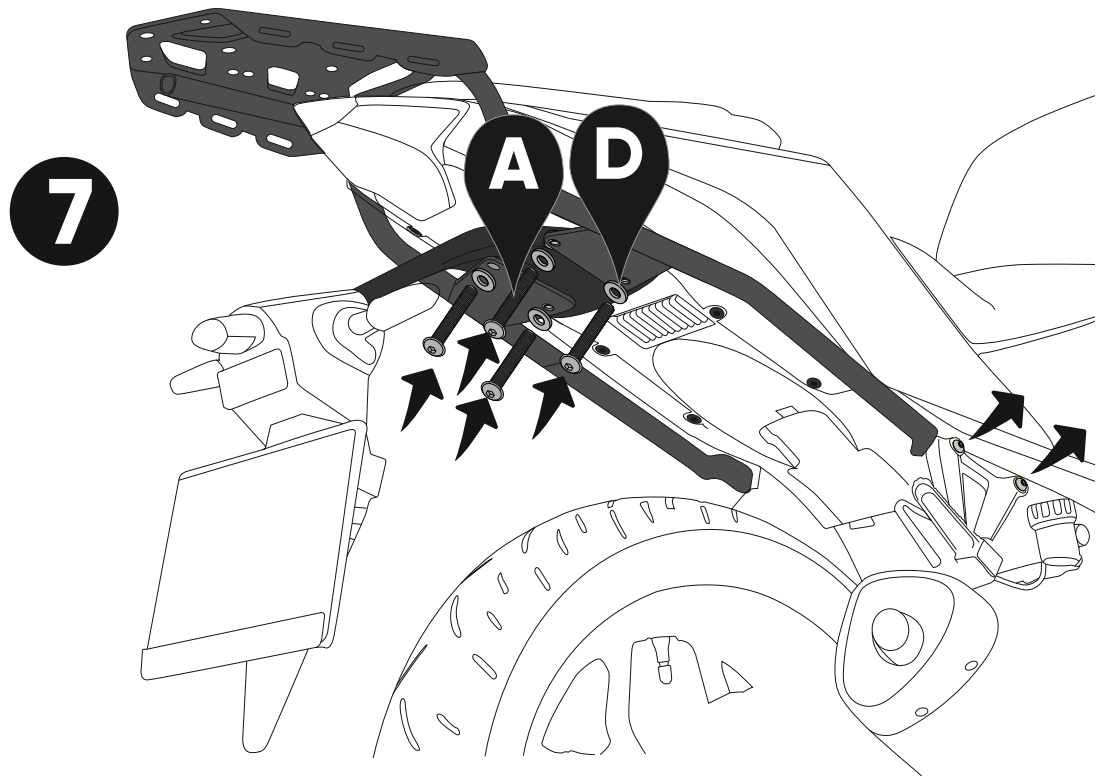

Montaj Talimatları

- 8-** Kuyruğun altından çanta demirini cıvatalarken aşama 8'de gösterildiği gibi sele altından somunlarla cıvataları destekleyin.
- 9-** Artçı basamağının söktüğünüz cıvataları yeniden takın, çanta demirinin bağlanmadığı yuvanın arkasına 1 adet büyük burç koyun. Kuyruğun 2. katmanını gösterildiği gibi traşlayın.

Mounting Instructions

- 8-** Support bolts with nuts under the seat as shown in step 8 while bolting the bag iron from the bottom of the tail.
- 9-** Re-attach the bolts that you removed from the passenger step, put 1 thin bush behind the slot where the bag iron is not connected. Shave the 2nd layer of the tail as shown.

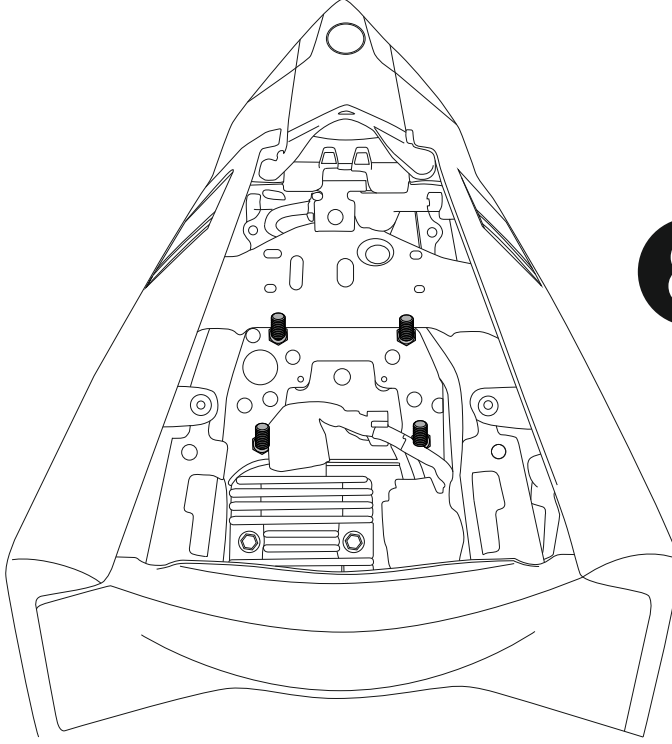

8

9

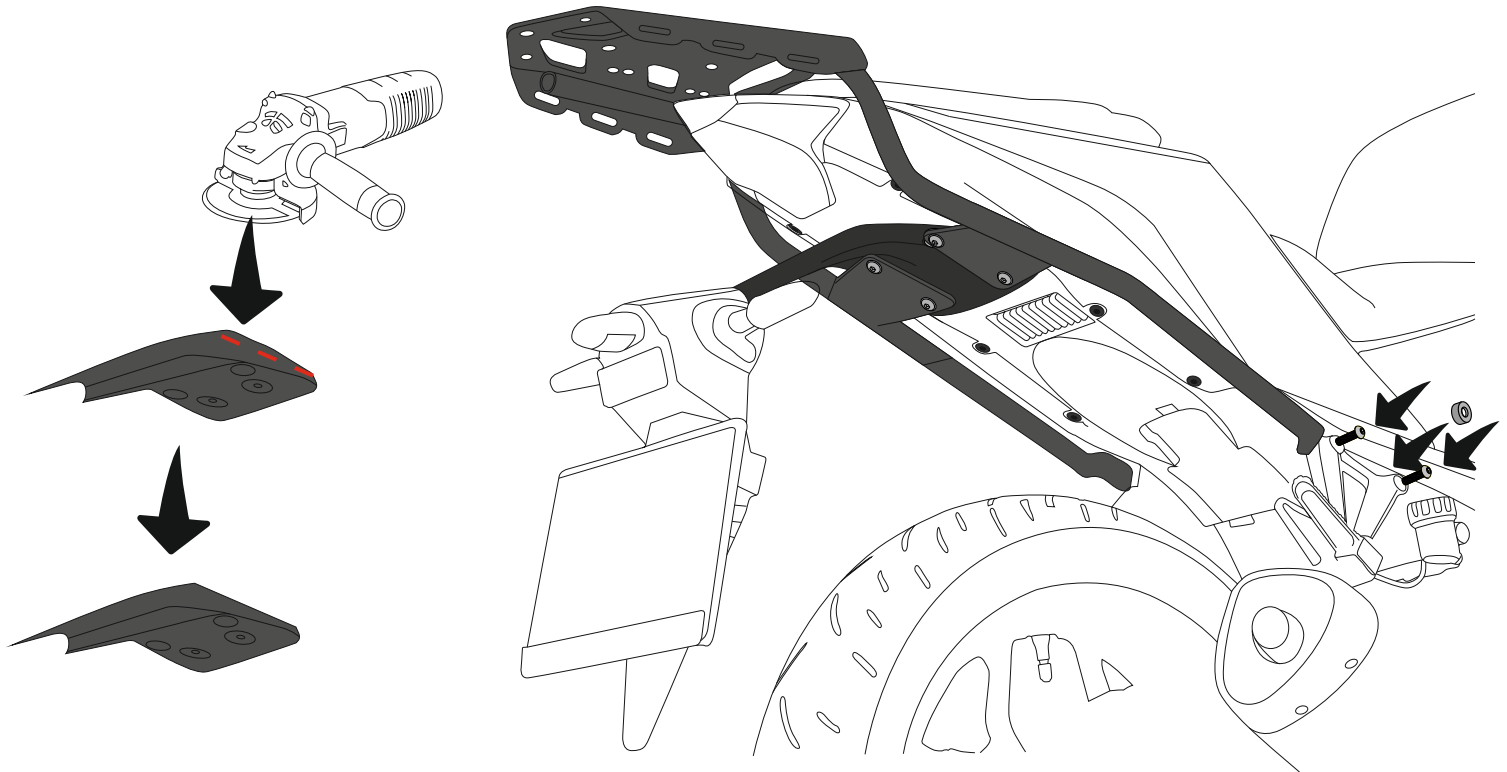

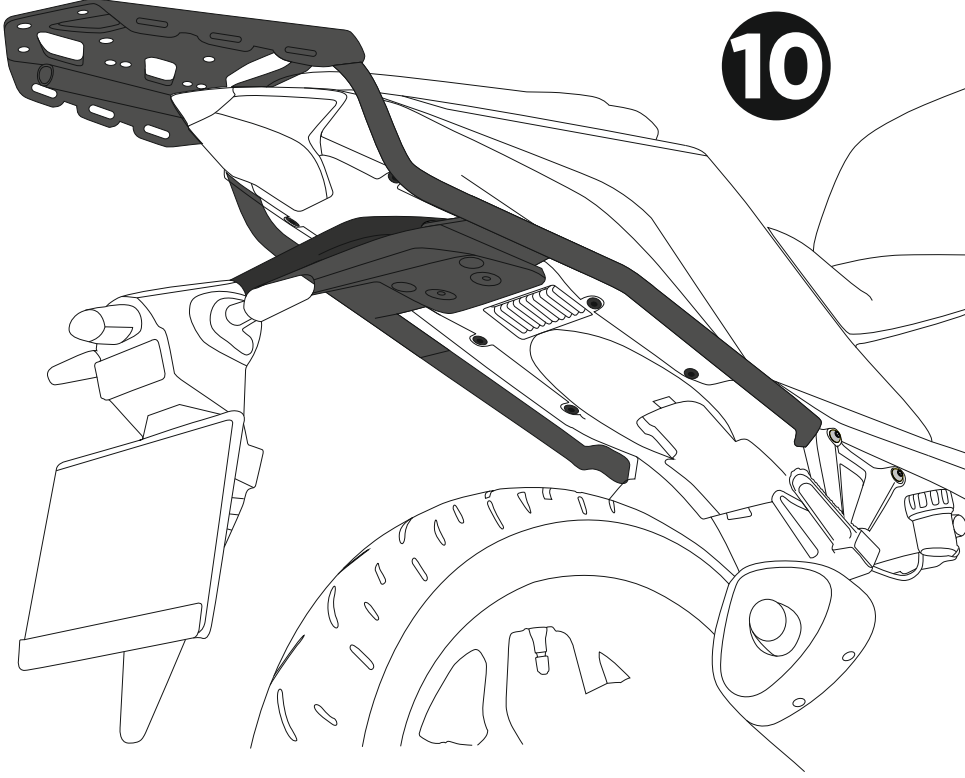

Montaj Talimatları

10- Aşama 10'da gösterildiği gibi kuyruğun 2. katmanını kapatın ve vidalamaya hazır hale getirin.

11- Aşama 11'de gösterildiği şekilde cıvataları yeniden yerlerine monte edin.

Mounting Instructions

10- Re-mount the 2nd layer of the tail as shown in Step 10 and prepare it for screwing.

11- Re-install the bolts as shown in step 11.

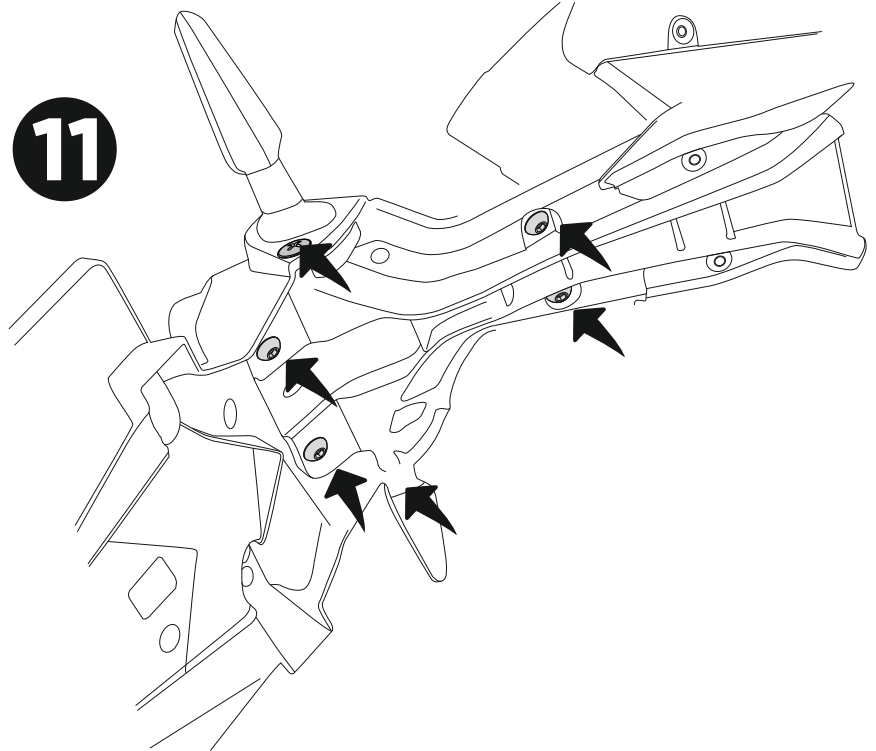

Montaj Talimatları

- 12-** Sele altı kapağını yerleştirin ve gösterildiği gibi klipslerini tekrardan takın.
13- Aşama 13'te gösterildiği gibi kuyruğun 3. son katmanını klipsleriyle monte edin.

Mounting Instructions

- 12-** Place the seat cover and reattach the clips as shown.
13- Mount the 3rd last layer of the tail with its clips as shown in Step 13.

12

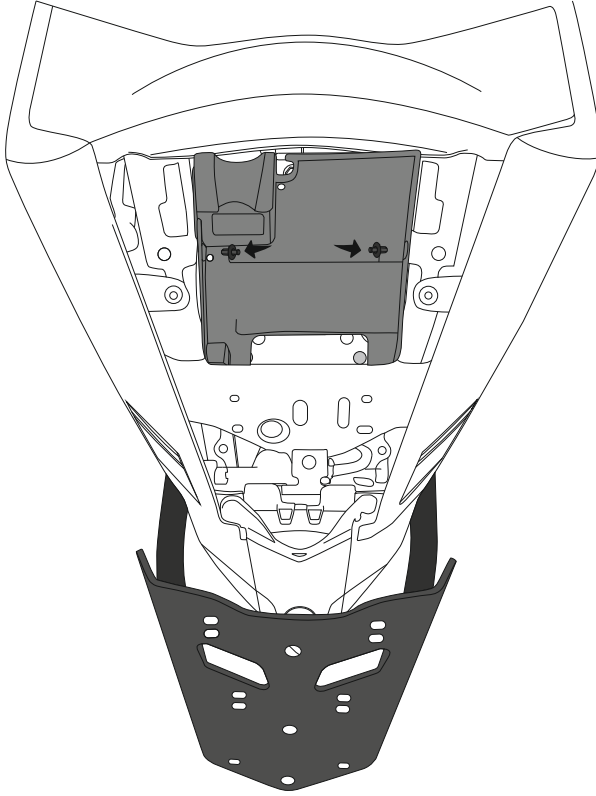

13

