











No	Adet Qty.	Parça • Parts	No	Adet Qty.	Parça • Parts
A	2 x	 (Bağlantı Demiri) (Fixing Part)	E	2 x	 (M6x5 Conta) (M6x5 Gasket)
B	2 x	 (Kovan) (Sleeve)	F	2 x	 (M6x16 Pul Başlı Cıvata) (M6x16 Bolt)
C	2 x	 (Kovan Kapağı) (Sleeve Cover)	G	2 x	 (M6 Somun) (M6 Nut)
D	2 x	 (M8x70 Havşa Başlı Cıvata) (M8x70 Bolt)			

Gerekli Aletler • Required Tools	
 (#14 Yarım Anahtar) (#14 1/2 Wrench)	 (#8 Yarım Anahtar) (#8 1/2 Wrench)
 (5 Alyan) (#5 Allen)	 (4 Alyan) (#4 Allen)

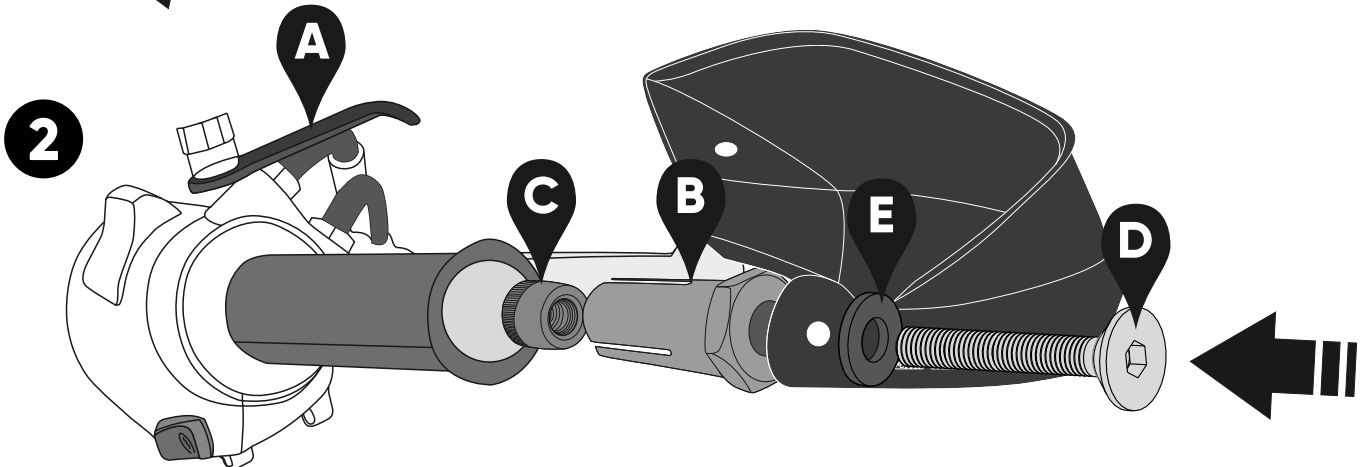
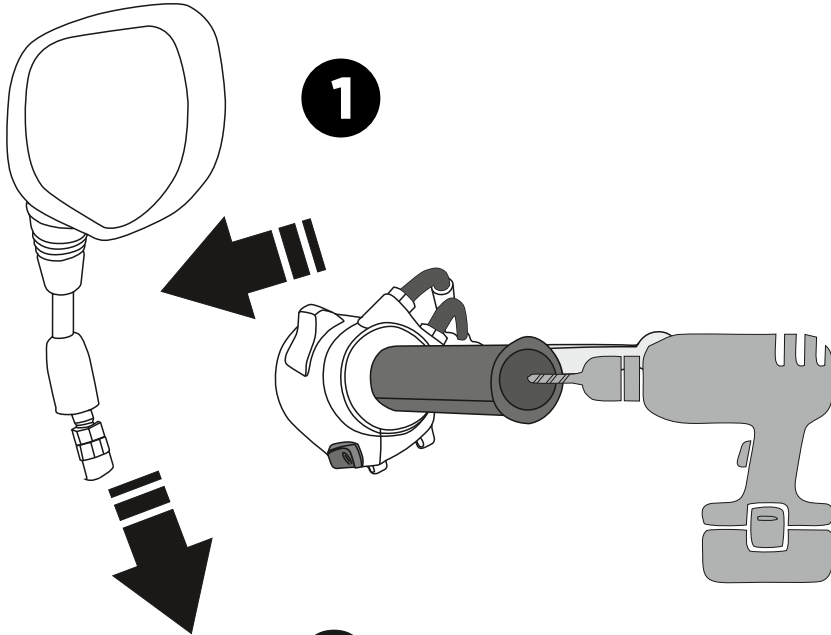

## Montaj Talimatları

- 1- Aşama 1'de gösterildiği gibi delici bir aletle elciğinize büyük bir delik açın, ayna ve ayna maşonunu yerinden 14 numara anahtar yardımı ile çıkarın.
- 2- Aşama 2'de gösterildiği gibi parçaları sırasıyla birbirlerine tutturun. Cıvataları tam sıkmayın. Ayna maşonunun altına bağlantı demirini yerleştirin.

## Mounting Instructions

- 1- As shown in 1.image, make a hole on handle and unscrew mirror and sleeve of mirror with #14 wrench.
- 2- As indicated in 2.image, fasten in order of parts. Not tighten screws. Fit the brackets under sleeve of mirror.

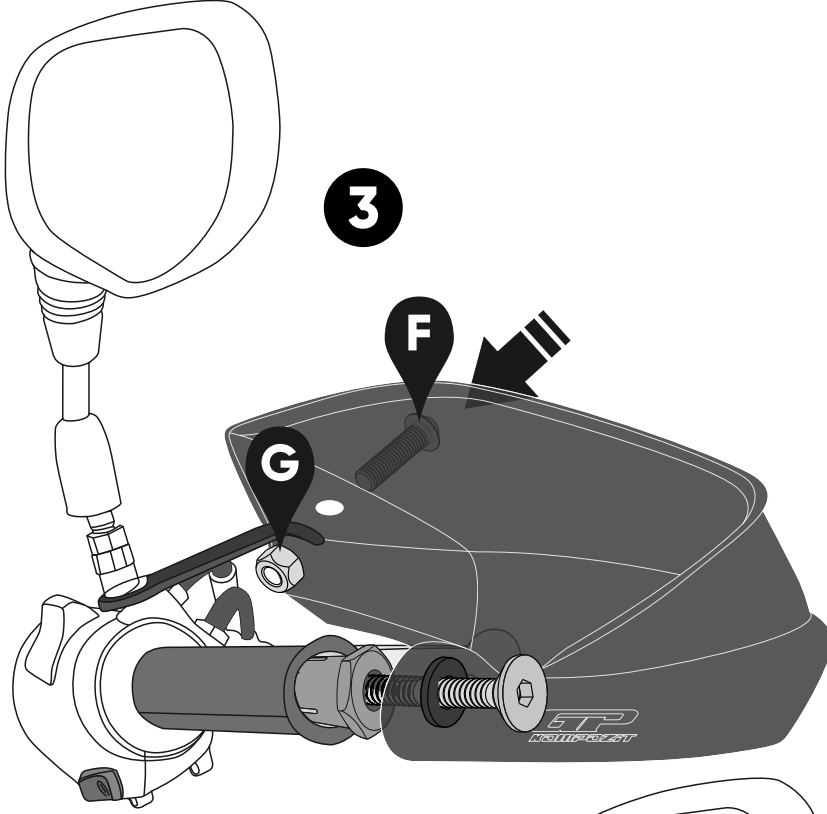

### Montaj Talimatları

- 3-** Aşama 3'te gösterildiği gibi elcik korumayı konumlandırın.
- 4-** Aşama 4'te gösterildiği gibi pul başlı civatayı elcik korumanın arkasından iç taraftan tuttuğunuz somunun içinden geçecek şekilde monte edin. Elcik korumanın yan kısmındaki montaj setini elciğin içinden geçirin ve M8x70 havşa vidayı 5 alyan yardımıyla sıkın.

### Mounting Instructions

- 3-** As shown in 3.image, make position handle guard.
- 4-** As indicated in 4.image, mount flake head screw with the held nuts that is behind the handle guard.Pass the mounting set through side of handle guard ,and tighten M8x70 screw with #5 allen wrench.

