

SIGHT MARK[®]

USER MANUAL



Core HX Rifle Scope Series

SM13067HHR

SM13068VHR

SM13068VHR-350L

SM13068VHR-450BM

SM13068HBR

SM13069VHR

SM13070VHR

ABOUT SIGHTMARK®

Sightmark offers a wide range of products that include red dot sights, reflex sights, riflescopes, laser sights, night vision and award-winning flashlights and boresights. Sightmark products are inspired by military and law enforcement applications. All products are designed to be the most effective weapon accessories possible.

SIGHTMARK® - MAKE YOUR MARK®



SIGHTMARK CORE HX SERIES

Designed solely for the field, the Sightmark Core HX Rifle Scope Series has been crafted to offer versatility to the modern hunter. The Core HX series of optics allows hunters to confidently prepare for the season ahead by providing the right reticle styles and features to match any pursuit.

Each scope in the Core HX lineup is constructed from a single piece of aircraft-grade aluminum for maximum durability. Built to withstand the most punishing conditions, the Core HX series of hunting riflescopes are shockproof, fogproof, and waterproof. Whether it's from a treestand strapped to a towering oak or peering over a ridgeline on a spot and stalk, hunters can take aim through a reliable optic that works with a variety of rifle calibers.

FEATURES:

- Single-piece 1" tube
- Aircraft grade aluminum
- Hard anodized finish
- Resettable, capped turrets
- Shockproof, fogproof, waterproof
- Multi-coated optics

INCLUDES:

- Neoprene scope cover
- 1" scope rings

TECHNICAL SPECIFICATIONS

	2-7X32HHR	3-9X40VHR/HBR	4-16X44AO VHR	6-24X50AO VHR
Reticle	HHR Hog Hunter Reticle	VHR Venison Hunter Reticle / HBR Hunter's Ballistic Reticle	VHR Venison Hunter Reticle	VHR Venison Hunter Reticle
Magnification, (x)	2-7	3-9	4-16	6-24
Objective lens diameter (mm)	32	40	44	50
Eye relief (in/mm)	4.7 - 4 / 119.4 - 101.6	4 - 3.7 / 101.6 - 94	4.3 - 3.8 / 109.2 - 96.5	4.3 - 3.8 / 109.2 - 96.5
Field of view (m@100m)	18.1 - 4.8	11.8 - 4	8.27 - 2.07	5.53 - 1.37
Field of view (ft@100yds)	54.4 - 14.4	35.4 - 12.2	24.8 - 6.2	16.6 - 4.1
Diopter adjustment (+/-)	±3	±3	±3	±3
Parallax setting (yds)	100	100	10 - ∞	10 - ∞
MOA adjustment (one click)	1/4	1/4	1/4	1/4
Windage adjustment range (MOA)	70	100	50	40
Elevation adjustment range (MOA)	70	100	50	40
IP Standard (water rating)	IP67	IP67	IP67	IP67
Body material	Aluminum	Aluminum	Aluminum	Aluminum
Lens coatings	Multi-coated	Multi-coated	Multi-coated	Multi-coated
Operating temperature (°F/°C)	0 to 120 / -17 to 49	0 to 120 / -17 to 49	0 to 120 / -17 to 49	0 to 120 / -17 to 49
Length (in/mm)	11.26 / 286	12.26 / 311.4	14.3 / 363.22	14.4 / 365.76
Weight (oz)	14	14.2	16.2	19.4

DIAGRAM

1. Eyepiece
2. Magnification ring
3. Windage/Elevation adjustment
4. Objective lens*

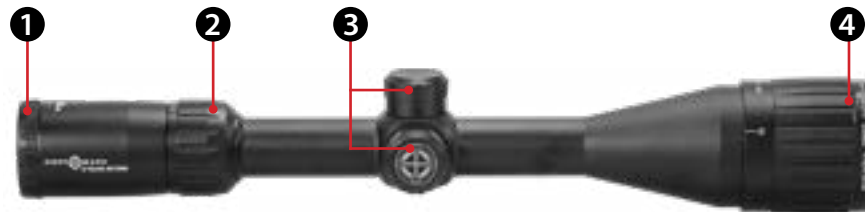

*4-16x44 and 6-24x50 are equipped with an adjustable objective lens system.

DIOPTER ADJUSTMENT

The Sightmark Core HX riflescope's eyepiece (1) is designed to rotate to adjust for diopter. The diopter is the measurement of the eye's curvature. People's eyes are all curved differently. If the reticle does not appear clear, crisp, nor sharp, rotate the eyepiece until the reticle becomes clear and sharp. This adjustment should stay the same unless the riflescope's operator changes.



OPERATING THE WINDAGE & ELEVATION ADJUSTMENTS

The Sightmark Core HX riflescopes come with pre-installed turret caps to protect the windage and elevation adjustments from impacts. The Sightmark Core HX riflescopes have finger adjustable elevation and windage adjustments (3) with audible clicks. Each scope has its MOA click value marked on the adjustment. For example, a ¼ MOA click means each click moves the point of impact .25" at

100 yards. 1 MOA of movement would require 4 clicks. In order to make windage and elevation adjustments:

1. Unscrew the adjustment covers.
2. Turn the adjustments in the appropriate direction needed to change the point-of-impact as indicated by the "UP" and "R" (right) arrows marked on the adjustments.

Note: For a 50 yard zero, the MOA value of the scope would be divided by 2. For example a ¼ MOA click would mean at 50 yards the point of impact would move .125" of adjustment.

VARIABLE POWER ADJUSTMENT

To change magnification, turn the magnification ring (2) to the desired level of power. The magnification levels are noted on the magnification ring. For variable power riflescopes, the magnification point in which ballistic holdovers are true is noted with a dot. The dot is an indication that the reticle's ballistic holdovers are true and will operate properly only at this power.



PARALLAX CORRECTION

The Sightmark Core HX 4-16x44AO VHR and 6-24x50AO VHR are equipped with an adjustable objective lens (4) that is used to eliminate parallax and finely focus the image. Parallax occurs when the image of the target does not focus at the same optical plane as the reticle inside the riflescope. When parallax is present, the reticle appears to move over the target when the shooter's eye is not centered to the eyepiece. Adjusting the adjustable objective lens properly will eliminate parallax. To adjust the adjustable objective lens:

1. Turn the dial on the objective lens (4) until the image of the target is as sharp as possible. If you know the distance to your target, use the yardage marks on the dial as a starting reference.
2. Check for parallax by moving your head back and forth while looking through the scope. If the reticle appears to shift slightly adjust the dial until all shifting has been eliminated. Parallax is eliminated when there is no apparent shifting of the reticle.

MOUNTING

The Sightmark Core HX riflescopes require 1 inch rings (included) for mounting. If using aftermarket scope rings, mount the scope per the scope ring manufacturer's instructions. Do not perform a final tightening of the rings prior to checking eye relief and reticle alignment. The riflescope should still be able to move fore and aft and rotate. To achieve maximum eye relief:

1. Set the riflescope to its highest magnification. For a fixed magnification riflescope, no magnification adjustment is necessary for this step.

2. Set the riflescope as far forward in the rings and slowly move the riflescope closer to your eye. Stop moving the riflescope once a full field of view is visible.
3. Next rotate the scope to vertically align the crosshair. Use a reticle leveling tool if available.
4. Once alignment is complete, tighten the mounting ring's screws evenly so the gap is even on both sides of the scope. Do not over tighten.

SIGHTING IN

Boresighting and test firing should be performed safely on a firing range. Laser boresights are a quick and accurate method for sighting in. The traditional method of boresighting is listed below.

1. When mounting the riflescope on a bolt action rifle, remove the bolt; or when mounting to a semi-automatic rifle, disassemble the rifle until there is a straight line of sight through the bore.
2. Use a target at least twenty yards to fifty yards away when sighting in the riflescope. Look through the bore of the weapon and locate the bull's-eye of the target.
3. Sight in the target through the bore and then make windage and elevation adjustments (see "Operating Windage and Elevation Adjustments" for instructions) to the riflescope until the reticle is centered on the bullseye.

To verify the riflescope is accurately sighted in, always fire a three-shot test group preferably using the same ammo manufacturer, grain, and lot number. 100 yards is the most common zero distance.

Before firing, make sure the image is properly focused and no parallax is present.

4. After firing a group use the center of this grouping to make adjustments to the elevation and windage, these adjustments will move your firearm's grouping to the center of the target.
5. Fire another three-shot test group to confirm adjustments and use the center of the new grouping to determine any final adjustments.

Once the riflescope is zeroed, the adjustment turret can be reset to zero. To do this:

1. Hold the turret firmly in place with your fingers in order to prevent rotation. Use a flathead screwdriver to loosen the screw on top of the turret. Carefully remove the screw.
2. Once the screw is removed, carefully lift the turret cap straight up and off of the turret.
3. Re-install the turret cap, so that the "0" mark is aligned with the line indicator on the riflescope. Re-tighten the screw to secure the turret. Do not over tighten. Repeat these steps for the other adjustment.



USING THE HUNTING SERIES RETICLES

HHR Hog Hunter Reticle

The Sightmark Core HX 2-7x32HHR riflescope is equipped with the HHR Hog Hunter reticle. This reticle was designed for hunting feral hogs. The design provides a fine .3 MOA central aiming crosshair at 7x, critical for precise aiming. At 2x, the outer 13 MOA circle is ideal for close range, quick acquisition shooting. At 7x, the same circle is 4 MOA at 100 yards which will cover 4" of the target, making it ideal size to align with the small vital zone of feral hogs. The duplex design was created to coincide with the average length of adult feral hogs, allowing for ranging of your target.

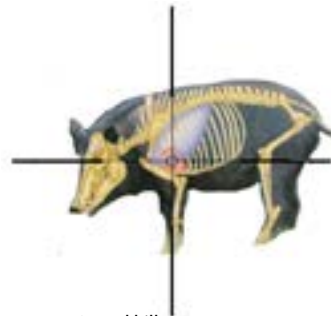

Figure 1- 50 yard kill

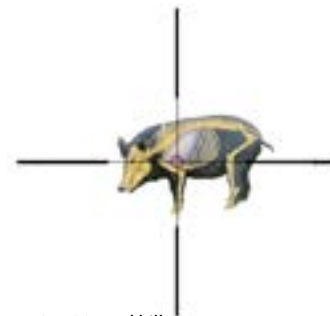

Figure 2- 100 yard kill

Ranging with the HHR reticle

The HHR reticle is designed to estimate the range of adult feral hogs based on the average overall length of the hog. Ranging is simple by matching the length of the hog (nose to tail) inside the set of brackets on the duplex reticle. The following images show approximately the size ratio for each range distance of 50yd, 100yd, 150yd, 200yd, and 300yd. For the most accurate range estimation, using a laser range finder is recommended. After ranging, ballistic compensation can be made to the elevation dial based on your caliber's ballistic performance. Note: range estimation must be done at 6x magnification.

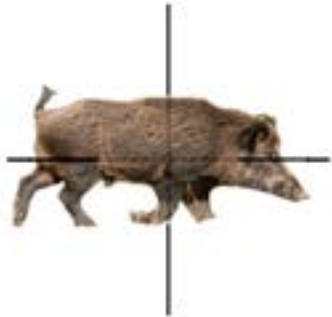

Figure 3- 50 yd

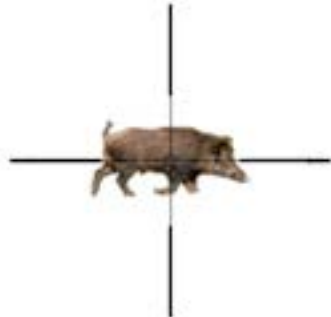

Figure 4- 100 yd

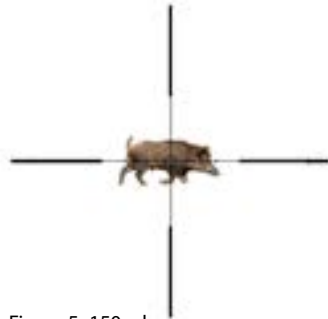

Figure 5- 150 yd

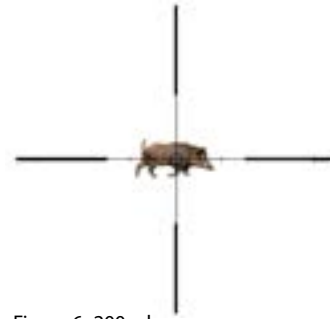

Figure 6- 200 yd

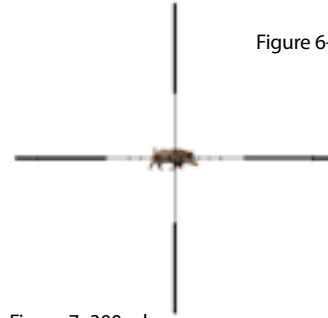

Figure 7- 300 yd

VHR Venison Hunter Reticle

The Sightmark Core HX 3-9x40VHR, 4-16x44AO VHR, and 6-24x50AO VHR riflescopes are equipped with the VHR Venison Hunter Reticle. The duplex design was created to coincide with the average shoulder height of whitetail deer, allowing for ranging of your target. The reticle's holdovers were designed for a variety of hunting calibers for hunting whitetail deer. Finally, the fine duplex design provides a .1 MOA central aiming crosshair at the highest magnification, critical for precise aiming at long ranges.

Ranging with the VHR reticle

The VHR reticle is designed to estimate the range of adult white tail deer based on the average shoulder height of the deer. Ranging is simple by matching the shoulder height of the deer inside the vertical brackets of the duplex reticle. The following images show approximately the size ratio for the distance for each mark. For the most accurate range estimation, using a laser range finder is recommended. Note: range estimation must be done at the appropriate magnification. For the 3-9x40, range estimation should be done at 9x. For the 4-16x44, range estimation should be done at 12x. For the 6-24x50, range estimation should be done at 18x.

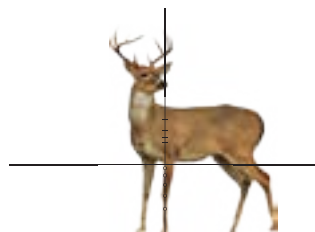

Figure 8- 100 yd



Figure 10- 300 yd



Figure 9- 200 yd

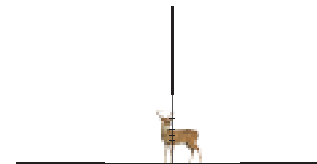
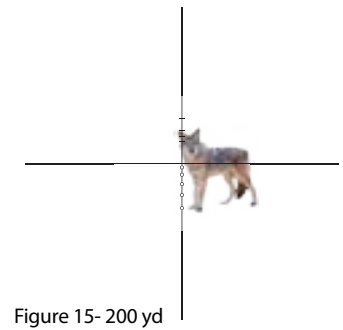
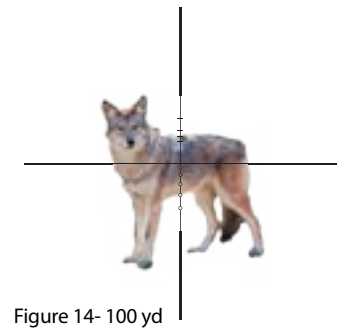
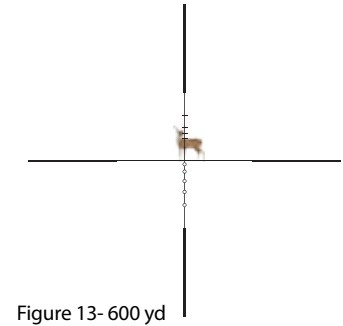
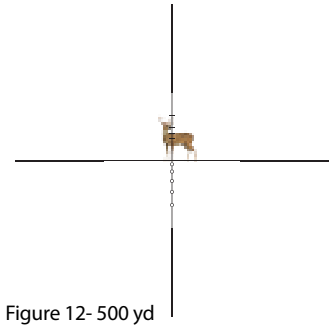

Figure 11- 400 yd

The VHR reticle can also be used for predator hunting, such as coyotes. Using the VHR reticle in this scenario, ranging would be performed by bracketing the coyote within the thick horizontal subtenions. On average, the length of a coyote in North America is 35" from head to rear (excluding the tail). For range estimation, a coyote would set just inside the thick horizontal brackets.



Using the Holdovers of the VHR reticle

The VHR reticle was designed to be compatible with a variety of hunting calibers for hunting whitetail deer (see compatibility chart). Group A calibers should be zeroed at 100 yards and will provide holdovers for 200yd, 300yd, 400yd, 500yd and 600yd. Group B calibers should be zeroed at 200 yards and will provide holdovers for 300yd, 400yd, 500yd, 600yd, and 700yd.

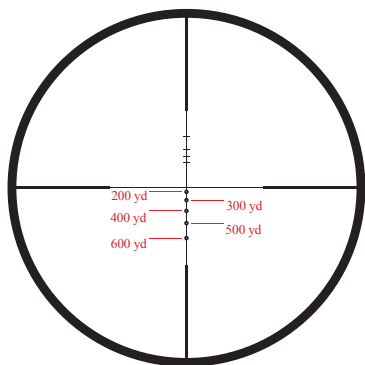

VHR RETICLE

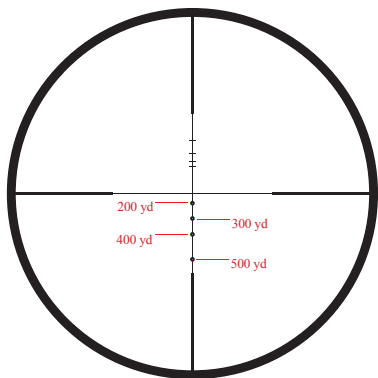

VHR 350 LEGEND AND 450 BUSHMASTER RETICLE

VHR HUNTING CALIBER COMPATIBILITY CHARTS

Group A Hunting Caliber Compatibility Chart 100 yard zero					
Caliber	Grain	Caliber	Grain	Caliber	Grain
.223 Rem	64	.308 WIN	150	.243 WIN	100
Avg. Velocity	62	Avg. Velocity	165	Avg. Velocity	95
3,000 FPS	60	2,750-2,800 FPS	180	2,950 FPS	
Caliber	Grain	Caliber	Grain	Caliber	Grain
.270 Win	150	6.5 Creedmoor	140	30-06	150
Avg. Velocity		Avg. Velocity		Avg. Velocity	165
2,800-2,850 FPS		2,700 FPS		2,700-2,900 FPS	180
Caliber	Grain				
280 REM	150				
Avg. Velocity					
2,900 FPS					

VHR 350 LEDGEND AND 450 BUSHMASTER COMPATIBILITY CHARTS

Caliber	Grain	Grain
350 Legend	150	2,325 FPS
450 Bushmaster	250	2,200 FPS

Group B Hunting Caliber Compatibility Chart 200 yard zero					
Caliber	Grain	Caliber	Grain	Caliber	Grain
300 Win Mag	165	7mm Rem Mag	150	25-06	115
Avg. Velocity	180	Avg. Velocity	139	Avg. Velocity	117
3,000-3,050 FPS		3,000-3,100 FPS		3,000 FPS	120
Caliber	Grain				
6.5 Creedmoor	120				
Avg. Velocity	129				
2,950-3,000 FPS	140				

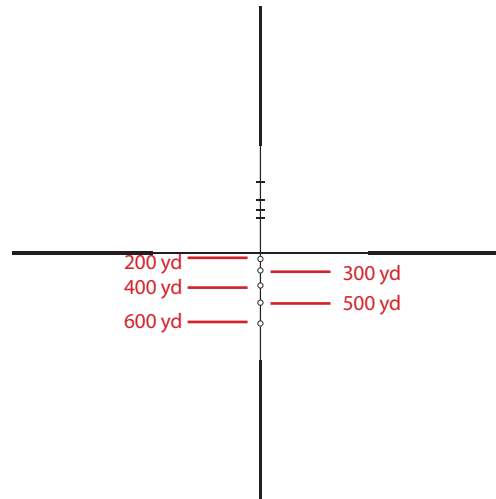

Figure 17- Group A holdover ranges

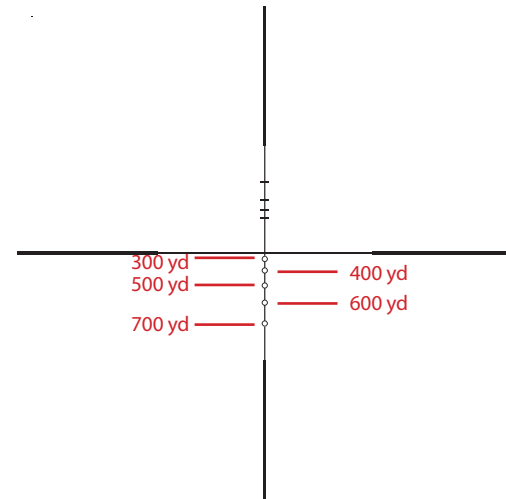

Figure 18- Group B holdover ranges

Finally, the VHR reticle is a second focal plane reticle. The advantage of a second focal plane reticle is that the size of the reticle will remain an ideal viewing size at any magnification. Ballistic holdovers, however, must be performed at a specific magnification for each model. Before firing with the holdover marks, adjust the magnification ring to the appropriate magnification. For the 3-9x40, the reticle's holdovers are true at 9x. For the 4-16x44, the reticle's holdovers are true at 12x. For the 6-24x50, the reticle's holdovers are true at 18x. In the example below, a 300 yard holdover is used by aiming with the second holdover dot.

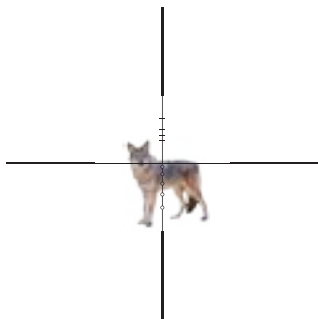

Figure 19- 300 yard holdover

HBR Hunter's Ballistic Reticle

The Sightmark Core HX 3-9x40 HBR is equipped with the HBR Hunter's Ballistic Reticle. The duplex design was created to coincide with the average length of a whitetail deer or coyote, allowing for ranging of your target. The reticle's elevation holdovers were designed for a variety of common hunting calibers. The reticle is also equipped with windage holdovers for 10mph crosswinds. Finally, the fine duplex design provides a .3 MOA central aiming crosshair at the highest magnification.

Ranging with the HBR reticle

The HBR reticle is designed to estimate the range of adult white tail deer and coyote based on their average length. Ranging is simple by matching the length of the animal inside the vertical brackets of the duplex reticle. The following images show approximately the size ratio for the distance for each mark. For the most accurate range estimation, using a laser range finder is recommended. Note: range estimation must be done at 9x magnification.

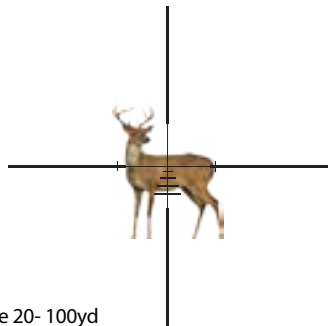

Figure 20- 100yd

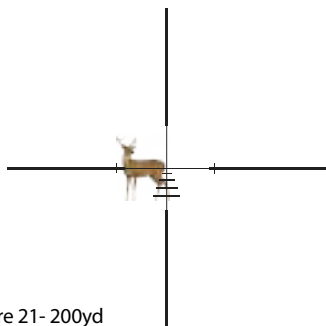

Figure 21- 200yd

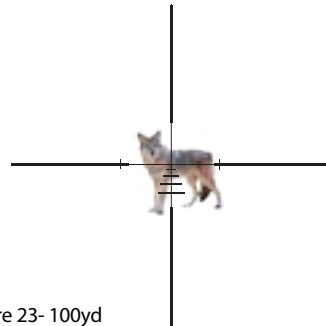

Figure 23- 100yd

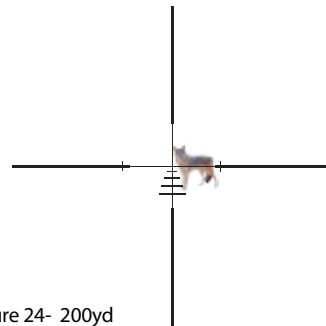

Figure 24- 200yd

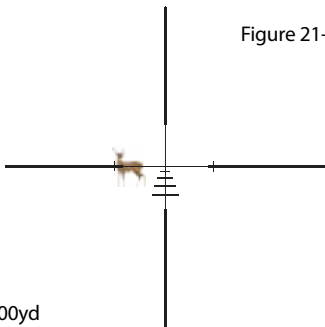

Figure 22- 300yd

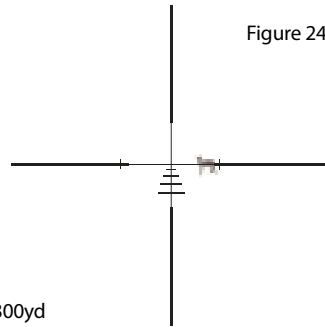

Figure 25- 300yd

Using the Holdovers of the HBR reticle

The HBR reticle was designed to be compatible with a variety of hunting calibers (see compatibility chart). Group A calibers should be zeroed at 100 yards and will provide holdovers for 200yd, 300yd, 400yd, 500yd and 600yd. Group B calibers should be zeroed at 200 yards and will provide holdovers for 300yd, 400yd, 500yd, 600yd, and 700yd.

HBR HUNTING CALIBER COMPATIBILITY CHARTS

Group A Hunting Caliber Compatibility Chart 100 yard zero					
Caliber	Grain	Caliber	Grain	Caliber	Grain
.223 Rem	64	.308 WIN	150	.243 WIN	100
Avg. Velocity	62	Avg. Velocity	165	Avg. Velocity	95
3,000 FPS	60	2,750-2,800 FPS	180	2,950 FPS	
Caliber	Grain	Caliber	Grain	Caliber	Grain
.270 Win	150	6.5 Creedmoor	140	30-06	150
Avg. Velocity		Avg. Velocity		Avg. Velocity	165
2,800-2,850 FPS		2,700 FPS		2,700-2,900 FPS	180
Caliber	Grain				
280 REM	150				
Avg. Velocity					
2,900 FPS					

Group B Hunting Caliber Compatibility Chart 200 yard zero					
Caliber	Grain	Caliber	Grain	Caliber	Grain
300 Win Mag	165	7mm Rem Mag	150	25-06	115
Avg. Velocity	180	Avg. Velocity	139	Avg. Velocity	117
3,000-3,050 FPS		3,000-3,100 FPS		3,000 FPS	120
Caliber	Grain				
6.5 Creedmoor	120				
Avg. Velocity	129				
2,950-3,000 FPS	140				

Using the windage holdovers of the HBR reticle

The HBR reticle is also equipped with windage holdovers. The tip of each elevation holdover is representative of a windage holdover in a 10 mph wind. The windage holdover is the same amount regardless of a 100 yard or 200 yard zero. For a 5 mph wind, use the middle of the subtension for proper windage holdover. For windage holdovers, always hold the reticle into the direction of the wind. For example, your distance to target is 300 yards and 10mph crosswind is coming from right to left. For this shot, the second holdover line is used and the left tip of the subtension is the aiming point. This aiming holdover will compensate for bullet drop and wind deflection. If the crosswind was 5mph, then use the middle of the crosswind subtension.

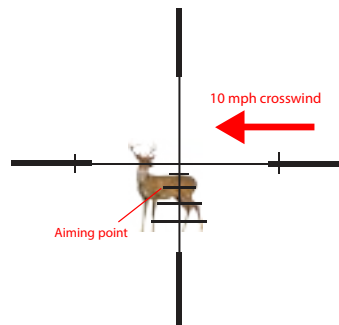

Figure 26- HBR reticle 10mph

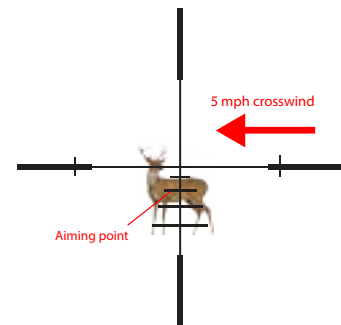

Figure 27- HBR reticle 5mph

MAINTENANCE

Proper maintenance of your Sightmark Core HX Riflescope is recommended to ensure longevity. It is recommended that when the sight becomes dirty that it is wiped down with a dry or slightly damp cloth. Blow dirt and debris off all optics and then clean lenses with a lens cleaning cloth. To remove oils or dried water spots, apply a small amount of denatured alcohol to a lens cloth or cotton swab. Clean the surface of the lens and let dry. Finally use your breath to clean the lens once more. No further maintenance is required. Do not attempt to disassemble any components of the scope.

STORAGE

Make sure that your Sightmark Core HX Riflescope is securely attached to your rifle before storing. Cover with the included neoprene cover.

WARNING

Before handling the Sightmark Core HX Riflescope read and understand the contents of your firearm's manual, and the Sightmark manual. Follow all standard safety precautions and procedures during firearm operation, even when the reflex sight is not in use.

- Avoid hitting or dropping the unit.
- ALWAYS check that the chamber of your weapon is clear before mounting or dismounting the riflescope.

TROUBLESHOOTING

Never ship back a product without getting proper authorization beforehand. Doing so could result in losing the product due to a multitude of reasons, i.e. sending it to the wrong address and other problems associated with unexpected packages.

If the riflescope does not hold zero:

1. Verify the sight is mounted securely to the rifle. If the scope can be shifted in any direction, retighten the mount according to the mounting instructions but do not over tighten. The sight will need to be re-zeroed afterwards.
2. Check that all screws on the mount are securely tightened.

The reticle is blurry and not in focus:

1. Rotate the eyepiece to adjust the diopter adjustment until the reticle becomes clear and sharp.

SIGHTMARK WARRANTY

Please visit www.sightmark.com for warranty details and information.

SIGHT  MARK[®]



WARNING: This product can expose you to chemicals including Butadiene and Cumene, which are known to the State of California to cause cancer, and Butadiene, which is known to the State of California to cause birth defects or other reproductive harm. For more information go to www.P65Warnings.ca.gov.

www.sightmark.com