

hermitlux

Tabletop Dishwasher

Manual

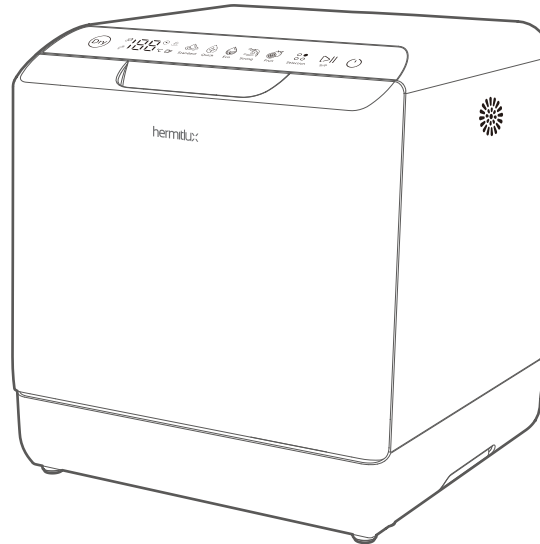

Please read the manual carefully. It contains important information on how to install, use and maintain the machine. Please retain all documents for subsequent use or for next owner.

LIST

Model No.: HMX-DW04

Safety and warning	02
Product Introduction	03
Control Panel	04
Installation	05
Tableware display	07
Operation	08
Functions	10
Maintain & Clean	11
Fault & Problem	12
Specification	16
RoHs Requirement	17

IMPORTANT SAFETY INSTRUCTIONS

WARNING When using your dishwasher, follow basic precautions, including the following:

- a) Read all instructions before using the dishwasher.
- b) Use the dishwasher only for its intended function.
- c) Use only detergents or wetting agents recommended for use in a dishwasher and keep them out of the reach of children.
- d) When loading items to be washed:
 - 1) Locate sharp items so that they are not likely to damage the door seal; and
 - 2) Load sharp knives with the handles up to reduce the risk of cut-type injuries.
- e) Do not wash plastic items unless they are marked 3 dishwasher safe 3 or the equivalent. For plastic items not so marked, check the manufacturer's recommendations.
- f) Do not touch the heating element during or immediately after use.
- g) Do not tamper with controls.
- h) Do not abuse, sit on, or stand on the door or dish rack of the dishwasher.
- i) To reduce the risk of injury, do not allow children to play in or on a dishwasher.
- j) Under certain conditions, hydrogen gas may be produced in a hot-water system that has not been used for two weeks or more. **HYDROGEN GAS IS EXPLOSIVE.** If the hot-water system has not been used for such a period, before using the dishwasher turn on all hot-water faucets and let the water flow from each for several minutes. This will release any accumulated hydrogen gas. As the gas is flammable, do not smoke or use an open flame during this time.
- k) Remove the door to the washing compartment when removing an old dishwasher from service or discarding it.
- l) **DO NOT IMMERSE IN WATER.**
- m) **HOUSEHOLD AND INDOOR USE ONLY.**
- n) It is forbidden to open the door while the appliance is working to avoid personal danger. Don't open the door when washing avoiding to hot water flying out causing any hurts

SAVE THESE INSTRUCTIONS

Safety and warning

Warning

1. Power socket must be grounded, avoiding to possible electric leakage or shock;
2. Don't share one 7.6A/ 10A socket with other appliance avoiding to fire.
3. An of new parts or power line will be changed by service man after damages;
4. Dispose of the machine in a environmentally friendly manner under local regulations;
5. Do not place the machine in the environment under 0 °C, like outside door in cold weather;
6. Please use the salt and detergent which is special for dishwasher;
7. Don't place and use the machine in the platform which is not stable, wet, smooth, inflammable avoiding to any damage;
8. Don't place and use the machine within 150mm far from gas stove or heater;
9. Don't place any heavy object on the door when door open avoiding to the machine turn over;
10. Don't splash water into the machine avoiding to electric shock or fire;
12. Don't drink the left water in the machine;
13. Don't let children operate the machine independently avoiding to any danger

Precaution

1. Don't open the door when washing avoiding to hot water flying out causing any hurts
2. Don't not touch or block the side air outlet;
3. Don't tilt or move the machine when washing;
4. The knife or others with sharp point do not face person avoiding to any hurts when open door;
5. Please stop washing, power off, and close tap when any faults;
6. Please check and clean the machine time from time in order to the best washing effect;
7. Please fix the drain hose avoiding to the stained water outflow;
8. Don't forcibly pull power cord, drain hose, press cutlery tray avoiding any damage;
9. Don't use wet hand to operate the machine avoiding electric shock;
10. Children should be far from the chemical material such as salt, detergent avoiding to any hurt.

Product Introduction

Machine

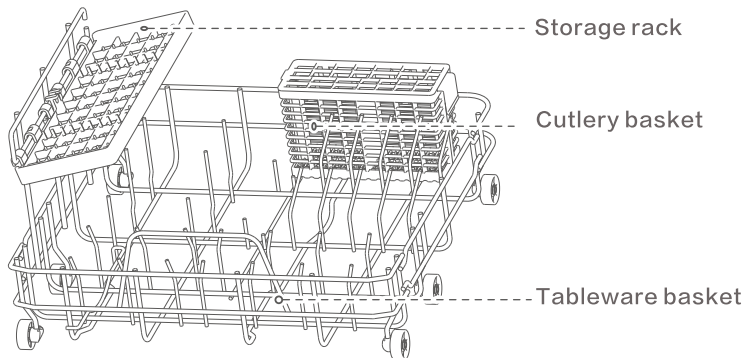
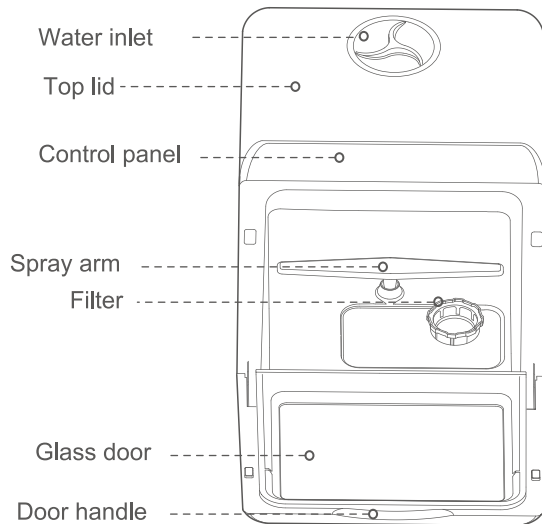

Parts list

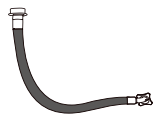

Inlet hose x1

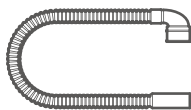

Drain hose x1

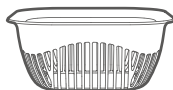

Fruit basket x1



Cup x1



Hose collar x1

Control Panel

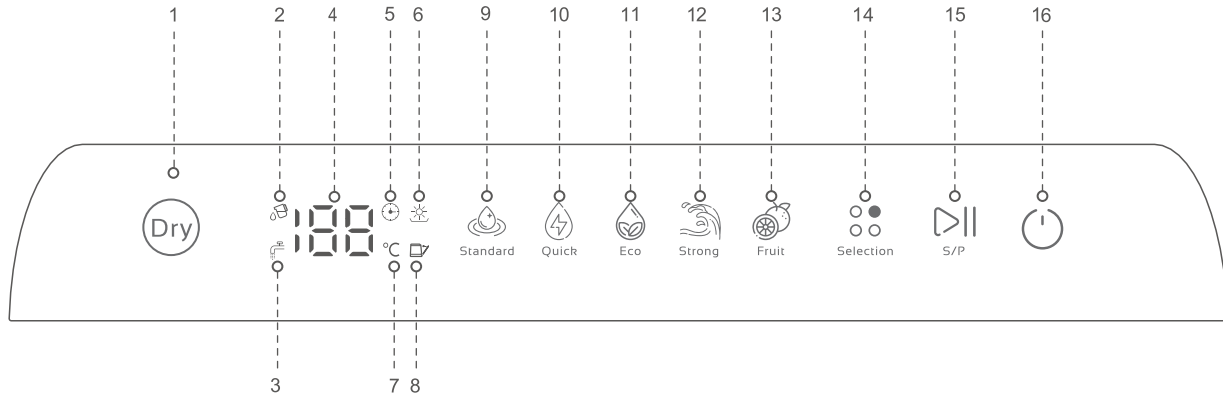

- 1.Dry
- 2.Tank model
- 3.Tap model
- 4.Display screen
- 5.Time display

- 6.Dry indicator
- 7.Temperature
- 8.Door open
- 9.Standard
- 10.Quick

- 11.ECO
- 12.Strong
- 13.Fruit
- 14.Program selection
- 15.Start/Pause
- 16.Power on/off

Installation

GROUNDING INSTRUCTIONS

This appliance must be grounded. In the event of a malfunction or breakdown, grounding will reduce the risk of electric shock by providing a path of least resistance for electric current. This appliance is equipped with a cord having an equipment-grounding conductor and a grounding plug. The plug must be plugged into an appropriate outlet that is installed and grounded in accordance with all local codes and ordinances.

WARNING - Improper connection of the equipment-grounding conductor can result in a risk of electric shock. Check with a qualified electrician or service representative if you are in doubt whether the appliance is properly grounded. Do not modify the plug provided with the appliance, if it will not fit the outlet, have a proper outlet installed by a qualified electrician.

1. Inlet hose installation

① connect machine

Insert inlet hose elbow into the water inlet behind machine and tighten the screw.

② connect tap

A、B、C three options for tap connection, but B and C options need make a hole on or behind cabinet in order the hose can go through cabinet.

Note:

the product has the characteristic of heating liquid;
the product can not be connected with hot water source;
the size of inlet hose elbow is 1/2" with inner thread, the tap size must be 1/2" with outer thread.

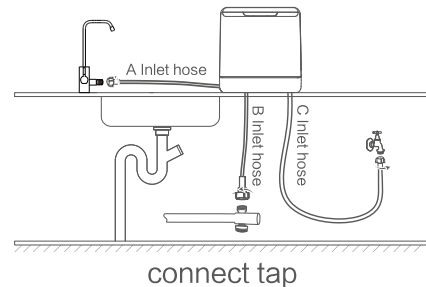
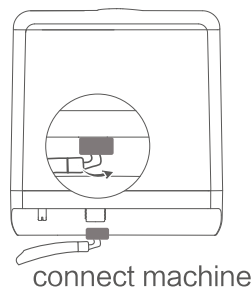

Installation

2. Drain hose installation

① Connect machine

Insert drain hose elbow to the water outlet behind machine and tighten the collar.

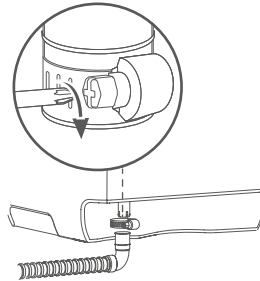

connect machine

② Connect sewer

A、B、C three options for sewer connection, B and C options need make a hole on or under cabinet in order the pipe can go through cabinet.

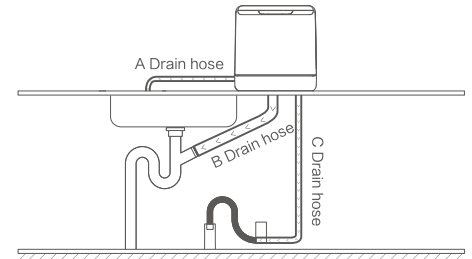

connect sewer

Note:

A hose that attaches to a sink spray can burst if it is installed on the same water line as the dishwasher. If your sink has one, it is recommended that the hose be disconnected and the hole plugged.

Tableware Display

- 1 Please get rid of large food residue on tableware, avoiding to block water hose.

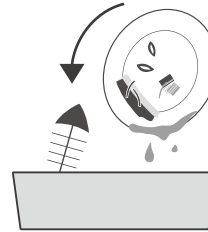

- 2 Please make reference to right pictures for tableware display.

Note:
In order to fully clean tableware, please tilt tableware internally or put stained face down.;
The capacity of maximum number of place settings is six.

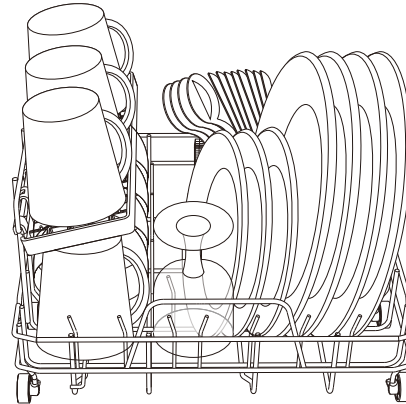

Operation

1 Power on

Plug in, touch “”, turn on the machine

Note:

Before program finishing, touch “” for 3 seconds to force the machine to turn off.



2 Add detergent

Open the door, add moderate detergent powder, or 1pc detergent block into the machine, close the door.

Note:

No detergent when fruit washing;
The dosage: 8-10g each washing circle.

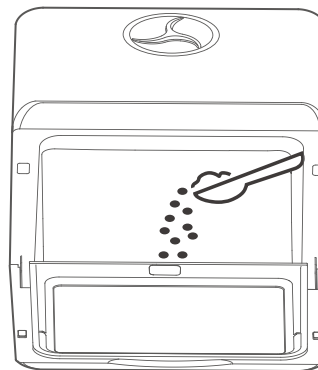

3 Program selection

Touch “”, each of program indicator will light one by one, select the program you want.





Operation

4 Run program

Touch “▶||”_{S/P}, run selected program, machine will check water supply automatically.

Note:



- ① The system will automatically check all supplies are appropriate, if the indicators “” and “” become red, you need open tap or fill tank;
- ② After 5 times checking, there is still no water supply, the machine will enter standby mode;
- ③ Touch “▶||”_{S/P} to force pause machine and add tableware during washing;
- ④ Touch “” for 3 seconds to quit program, the machine will drain, then stop;
- ⑤ Touch “Dry” to add 73 hours' circular wind to keep air fresh inside machine.



5 Wash

The machine has two water supply models, tap model and tank model.

Note:

- ① The indicator “” is white, means tank model;
- ② The indicator “” is white, means tap model;
- ③ If tank is full, the machine will switch into tank model automatically;
- ④ Fill 3 cup of water into tank, Di, Di, Di will be sound if tank is full, the indicator “” will become white;
- ⑤ If tap model, please open water tap.

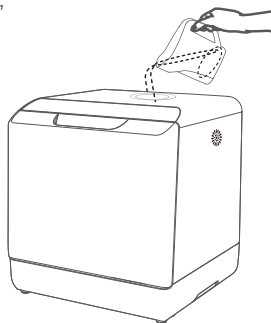

Fill water by hand
(For tank model)

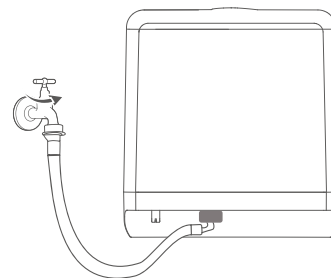

Connect tap
(For tap model)

Functions

Program	Program execution	Time	Detergent	Temperature	Drying time	Storage (if selected)
Standard	Hot water washing Cold water rinsing Cold water rinsing Hot water rinsing	69Min	8g	Washing 55 °C Rinsing 68 °C	60Min	Circulating fresh air 73 hours
Quick	Hot water washing Cold water rinsing Hot water rinsing	29Min	8g	Washing 50 °C Rinsing 62 °C	60Min	Circulating fresh air 73 hours
Strong	Hot water washing Hot water rinsing Cold water rinsing Hot water rinsing	89Min	12g	Washing 60 °C Rinsing 55 °C Rinssing 75 °C	60Min	Circulating fresh air 73 hours
ECO	Hot water washing Cold water rinsing Hot water rinsing	59Min	8g	Washing 55 °C Rinsing 68 °C	60Min	Circulating fresh air 73 hours
Fruit	Cold water rinsing Cold water rinsing	19Min	/	/	/	/
Dry	/	/	/	/	60Min	Circulating fresh air 73 hours

Maintain & Clean

1. Clean Filter

① Disassemble.

Rotate anticlockwise to disassemble the filter set, Which have 3 parts, filter mesh, main filter and fine fileter.

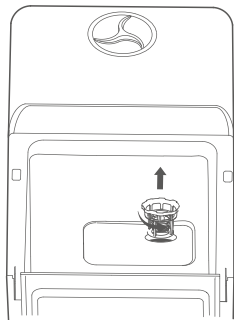

② Clean

Use water to flush and brush each of filter parts.

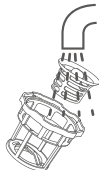

③ Assemble

After cleaning, rotated clockwise to close the filter set.

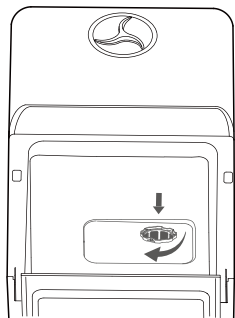

2. Clean spray arms

① Disassemble

Open the door, take out the basket, then pull out the up and down spray arm

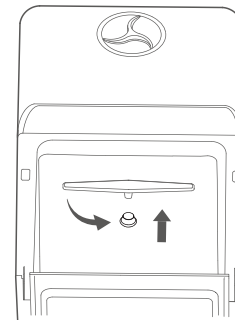

② Clean

Use water to flush and brush each spray arm, use tools with sharp point, like needle to clean holes if needed.

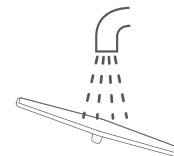

③ Assemble

After cleaning, please press each arms into position, make sure the arms can move smoothly.

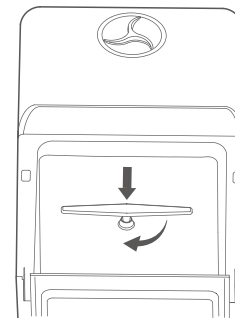

Fault & problem

1. Fault codes

Code	Fault	How to deal with
"E2"	Draining	1. Check drain pipe, be sure the pipe is straight, no bending; 2. Power off, check if anything block filter or drain pipe; 3. Be sure all pipes are not blocked by something.
"E3"	Overflowing	Tilt the machine to 30~45 degree, let water flow out from base of machine, restart machine, if still fault, contact our serviceman.
"E4"	Temperature	Restart machine, if still fault, please contact our service man.
"E5"	Massage	
"E6"	Heating	
"E7"	Pressure	

Fault & problem

2.Problem(1)

Problem	Reason	How to deal with
Tableware is not clean	Incorrect tableware loading	Be sure enough gap between tableware.
	spray arm trapped	Be sure nothing trap the spray arm.
	Blocked spray arm	Clean spray arm.
	Blocked filter	Clean filter set.
	Incorrect filter installation	Correctly assemble filter set.
	Incorrect program selection	Select appropriate washing program.
	No detergent	Add detergent (block/powder/liquid).
Don't start the machine	Water shortage	Add water till the indictator light off.
	Door do not close fully	Check the door if anything stop closing fully.
Can not select program	Be washing	Re-select program after stop in-progress program or wait in-progress program finishing .

Fault & problem

2.Problem(2)

Faults	Reason	How to deal with
Tableware is wet	Inappropriate program	Select appropriate program
	Poor dry effect for plastic tableware	Wipe to dry by hand
	Incorrect tableware setting	Correct tableware setting in accordance
	Drying program not finish	Wait dry program finishing
	Wooden tableware	Wipe to dry by hand
Discoloration of plastic tableware	over high washing temperature	Select program with lower temperature
Detergent left	Blocked spray arm, no water flush detergent	Be sure spray arm move smoothly
	Detergent with poor quality	Use qualified detergent

Fault & problem

2.Problem

Faults	Reason	How deal with
A mount of foam in the machine	Use incorrect detergent	1.Use special detergent for dishwasher; 2.Open machine, wipe out foam by hand; 3.Fill 2-3L water into machine, select any program, after 1-2 min, the foam will be drained, can repeat the process if needed.
Abnormal sound in the machine	Spray arm knock tableware	Correctly set the tableware
	Tableware move slightly	Fix tableware before washing
Egg custard left on the tableware	Portein solidification	Clean the tableware with egg custard by hand
Water drops left inside of machine	Drying time is not enogh	Selet "Dry"prorgram

Specification

Machine

Model No.:	HMX-DW04
Voltage	120V~
Hz	60Hz
Power	900W
Inlet pressure	0.03~1Mpa
Water consumption	5L
Place setting	4sets
Net weight	12KG
Machine size (WXD _X H)	428 × 425 × 458(mm)
Carton size (WXD _X H)	530 × 525 × 560(mm)
Dry	Hot wind

Electrical Drawing

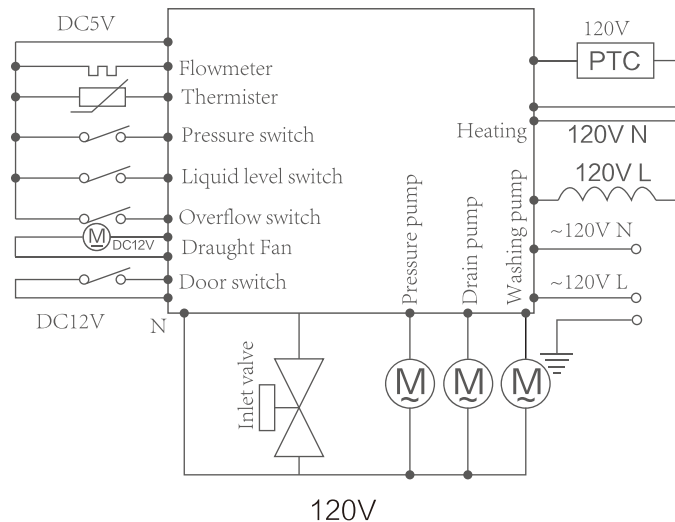

RoHS Requirement

Hazardous substances content						
Components	substances					
	Pb	Hg	Cd	Cr6+	PBB	PBDE
Plasti parts	0	0	0	0	0	0
Metal parts	0	0	0	0	0	0
Rubber parts	0	0	0	0	0	0
Screws	0	0	0	0	0	0
Stickers	0	0	0	0	0	0
Heat plate	0	0	0	0	0	0
Wire	0	0	0	0	0	0
Water pumps	0	0	0	0	0	0
PCB, Fan	X	0	0	0	0	0
Water valve	0	0	0	0	0	0
Parts of others	0	0	0	0	0	X

The table is made according to SJ/T11364 standards.

O: indicates the hazardous substance contain is below the limitation of GB/T26572 standards.

X: indicate the hazardous substance contain is over the limitation of GB/T26572 standards, but fit for the ROHS order.

The information of the table is offered by suppliers, under the present skills, we will keep the best level of hazardous substance in all of machine parts. We promise that we will try our best to low the level of hazardous substance in the machine through improving the technologies constantly.



ZHIYUAN APPLIANCES CO., LIMITED

3/FWORKINGTON TOWER 78 BONHAMSTRAND SHEUNG WAN HK

Email:support@hermitlux.com Website:www.hermitlux.us

Customer Service: +852 6723 9361

Warranty Card

Product

Tabletop dishwasher

Model

HMX-DW04

Sr.No.of Product

Cash memo no./
Date of Dealer

Name & Address/
Stamp of Dealer

Signature of Dealer

NOTE.

For easier reference, please present Original Sales Invoice or Official Receipt when claiming warranty.
The Manufacturer and/or Exclusive Distributor has the sole discretion in determining the cause of defects.