



Contact information
Engwe Bikes
service@engwe-bikes.com
www.engwe-bikes.com

Y10

Please read this manual carefully before using your electric scooter

Thank you for choosing to join the ENGWE E-BIKES family.

We invite you to read through this user manual to learn about your electric scooter and what it is like to own one.

First and foremost, remember to be safe out there. Your scooter is an accessory to your lifestyle and activities. Always follow best practices and traffic rules.

Even in this ever-evolving technology, it therefore requires basic maintenance and care to always function properly. Preventive maintenance is the name of the game. We invite you to grow with us and take advantage of our modular technical design.

Instructions, videos and live support are being created to provide you with all the knowledge you need to make the most of your Engwe scooter.

I	Safety instructions	< 01 >
II	Product description and assembly instructions	< 03 >
III	Maintenance	< 09 >
IV	Specification table	< 10 >
V	Instrumentation and operation	< 11 >
VI	Trademark and legal notices	< 16 >
VII	Warranty Card	< 17 >

1. Electric bikes are not allowed on public transport roads, please observe local laws and policies when driving the N10 SE.
2. Scooters are a leisure product. You will need to practice before you can master the riding skills. Engwe is not responsible for any injury or damage caused by the rider's inexperience or failure to follow the instructions in this document.
3. Before lending your scooter to someone, make sure they have read this manual, watched the instructional video and received a beginner's guide. It is your responsibility to ensure the safety of your new passenger. Please assist him/her in learning to use the product until he/she learns the basic operation of the scooter. Please ensure that each new rider wears a helmet and other protective equipment.
4. Following the tips and warnings in this manual will reduce the risks, but will not eliminate all risks. Please remember that when you use a scooter you may be at risk of injury or death through loss of control, collisions and falls. Scooters are only suitable for use on the hard surfaces above. It is recommended that you use them in relatively enclosed road environments (e.g. small areas, parks, dedicated fields, etc.) and do not cross areas with obstacles and contact points. Be alert and slow down when entering unfamiliar environments.
5. To reduce the risk of injury, you must read and follow all the 'Caution' and 'Warning' notices in this manual. Do not exceed the speed limit and do not ride on motorways.
6. For your first ride, do not choose areas where children, pedestrians, pets, vehicles, bicycles, etc. may be an obstacle and a potential hazard.
7. Please respect the rights of pedestrians when riding. Avoid frightening pedestrians, especially the elderly, children, the disabled and pregnant women. Alert pedestrians when approaching them from the rear and slow down when overtaking them. Please obey local traffic laws.
8. When riding in countries and regions where there are no laws or regulations relating to electric scooters, the safety requirements for riders in this manual must be strictly adhered to. Engwe shall not be liable for any property damage, personal injury, accident or legal dispute arising from the user's violation of the safety tips in this manual.
9. Before riding the scooter, check and ensure that there are no loose fasteners or damaged parts. If the scooter makes an unusual noise or alarm, stop using it immediately and consult your point of purchase or send an email to the manufacturer.
10. When riding, please observe the road surface, avoid obstacles and have level ground (including but not limited to wet ground, loose sand, rocky ground, ice).
11. This product is suitable for ages 14-60 and weighs up to 120kg.
12. Do not attempt to charge your electric vehicle when the charging port, charger or power outlet is wet.
13. Ensure that the scooter is charged with the original Engwe charger.
14. Use only Engwe approved parts and accessories. And do not modify your scooter.

Y10

13. Ensure that the scooter is charged with the original Engwe charger.
14. Use only Engwe approved parts and accessories. And do not modify your scooter. Modifying the scooter may affect the operation of the scooter and result in serious personal injury and invalidation of the warranty.
15. Children should not use scooters or play with scooter parts. When riding, the body vibration of the scooter can cause the driver's body to vibrate.
16. It is recommended to park on a flat, firm surface. If parking on a slope, the stand must face downhill to prevent tipping over. Do not allow the scooter to rush down to prevent the kickstand support from closing under gravity and the vehicle from tipping over. After lowering the kickstand, check that the vehicle is stable to prevent it from tipping over (slipping, wind, shaking). Do not park in busy areas. It is recommended to park against a wall. Please try to park the scooter on a flat road.
17. For a better driving experience, regular maintenance of the product is recommended.
18. Please read the user manual before charging.
19. Do not touch the brake parts of the scooter as this may cause injury.

Please observe the following safety tips:

- A. People who are not suitable for this mobility scooter include: people under the influence of alcohol or drugs, people who are unable to perform strenuous exercise due to illness, people who are unable to maintain their balance. People whose weight exceeds the prescribed limit (see "Specifications" in the instructions for use), and pregnant women.
- B. Minors need to be supervised by adults on scooters.
- C. Please observe local laws and regulations when riding. Please do not ride your scooter in areas where it is prohibited by local law.
- D. In order to ride safely, you must ensure that you can see the area in front of you and that you can be seen by others.
- E. Do not ride in snow, rain, slippery, muddy or icy weather for any reason. Do not ride your scooter over obstacles (sand, rocks or barricades) as this may result in a loss of balance or grip, which could lead to a fall.
- F. Damage and losses caused by water ingress are not covered by the warranty.
- G. Please do not drive at night.
- H. Please do not accelerate or decelerate suddenly. Please do not exceed the speed limit; otherwise, there may be a risk of loss of control, collision and fall.

1.Part Information

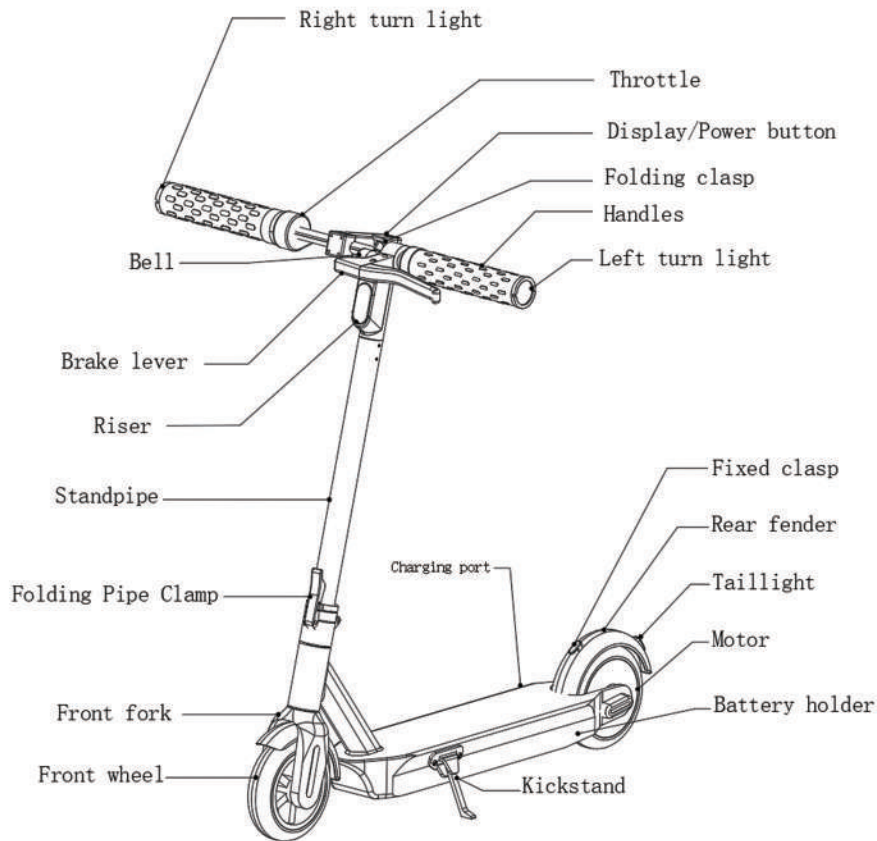

2.Packing list

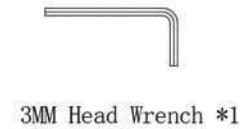
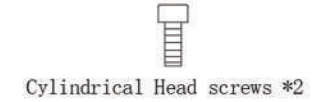

User Materials



Please check carefully that the contents of the box are complete and in good condition. If any parts are missing or damaged, please contact your point of purchase or send an email to the manufacturer. Please keep the box and packing materials for at least 15 days in case you need to ship the scooter later.

3.The whole car assembly instructions

3.1 Take out the whole car to fix the foot brace with the frame and open the foot brace to stand on the ground .

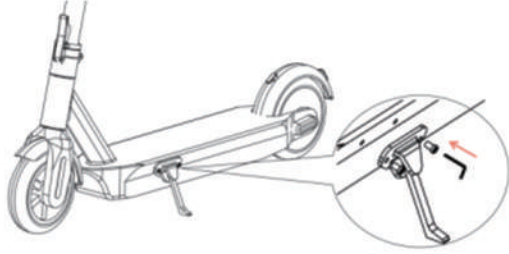

3.2 Install the horizontal handle to the vertical tube, pay attention to the headlight needs to face the front, and the vertical tube hole alignment, and then fixed with screws to lock.



3.3 After the installation is complete, the power on detection.



4.Charging steps

4.1 Open the charging port rubber plug and insert the charging plug.
4.2 Tighten the rubber cover after charging is completed.

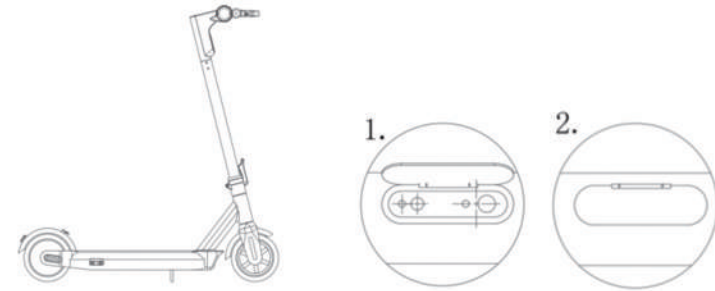

Warning

Please use the original charger for charging, otherwise there is a risk of battery damage or fire. Please do not connect the charger when the charging port or charging cable is wet. If the battery is broken or water, do not charge or continue to use the battery. Turn on the power switch, when all 5 power bars on the dashboard are always on, the scooter charging is complete.

5. Folding and handling

5.1 Scooter off, hand on the vertical tube, dial the folding finger dial, open the folding wrench.

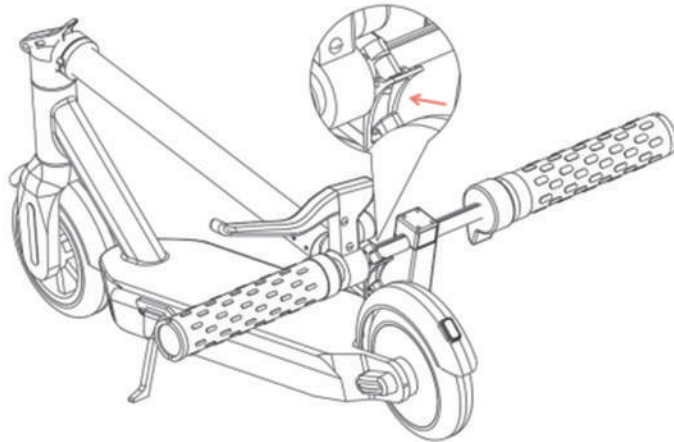

5.2 Align the folding snap ring and the snap on the rear fender and hook the two together.

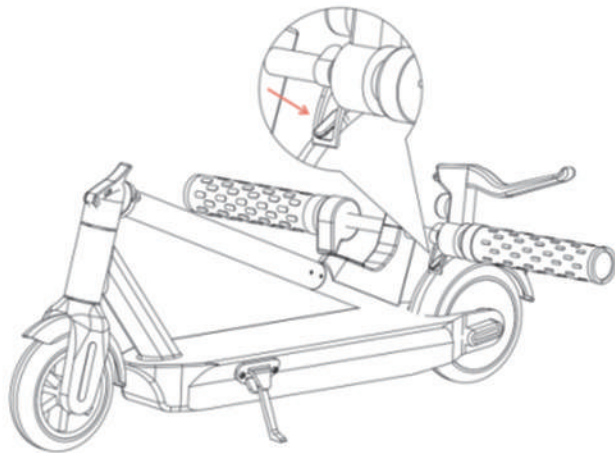

5.4 After folding, hold the riser for handling

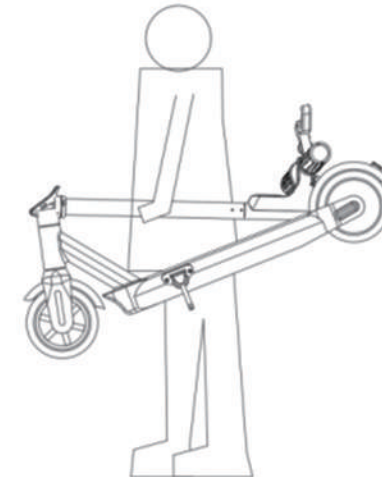

1.Cleaning

Use a soft, damp cloth to wipe the main unit. To remove hard dirt, scrub with a toothbrush and toothpaste, then clean with a soft, damp cloth.

2.Warning

Do not use alcohol, gasoline, kerosene or other corrosive, volatile solvents to clean your scooter. These substances may damage the exterior and interior structure of the scooter body. It is forbidden to spray water on the scooter with a pressure water gun or hose. Before cleaning, make sure the scooter is powered off, the charging cable is unplugged, and the rubber cover of the charging port is closed. Otherwise, the electronic components or battery may be damaged.

3.Storage

When the scooter is not in use, place it in a bright, dry place. Do not park the scooter outdoors. Sunlight exposure or extreme temperature conditions (too hot and too cold) will accelerate the deterioration of the plastic parts and may result in shorter battery life.

4. Battery removal and maintenance

Do not use third-party batteries without permission, as this is a safety hazard. Do not store or charge the battery at temperatures beyond the specified limits (see specifications). Do not touch the battery contacts and do not remove or pierce the battery case. Avoid metal objects touching the battery contacts to cause a short circuit; otherwise, battery damage or even personal injury may result. Do not put the battery into fire; otherwise, it may lead to battery failure, overheating, or even the risk of fire. Do not charge or use the battery if it is damaged or if water stains are seen. Do not try to disassemble the battery; otherwise, there is a risk of fire. Users must not repair the parts inside this scooter without permission. Do not ride the scooter at temperatures that exceed the specified limits (see specifications), as the power of the motor will be limited, which may result in slips and falls. Improper disposal of used batteries may seriously pollute the environment. Please observe local regulations when disposing of the battery. Do not dispose of this battery at will.

Performance index	Project	Y10
Basic Parameters	Packing box size	1220*180*580
	wheel Size	10Inches
	Body Material	AL6061
	Maximum Load	330.6lbs(150KG)
	Vehicle weight	69.4lbs(31.5KG)
Main Parameters of the	Maximum Speed	19.88mph(32km/h)
Whole vehicle	Maximum Gradient	30°
	Mileage Range	64.3miles(40km)
	Working Temperature	-4-140°F(-20-60°C)
Battery Parameters	Rated Voltage	36V
	Battery Capacity	13 AH
	Service Life	500 Times
Motor Parameters	Motor Power	350 W
	Motor Type	Brushless Gear Motor
	Maximum Torque	70Nm
Charger Parameters	Input voltage	100-240V
	output voltage	42v
	output Current	2A

1. Interface description

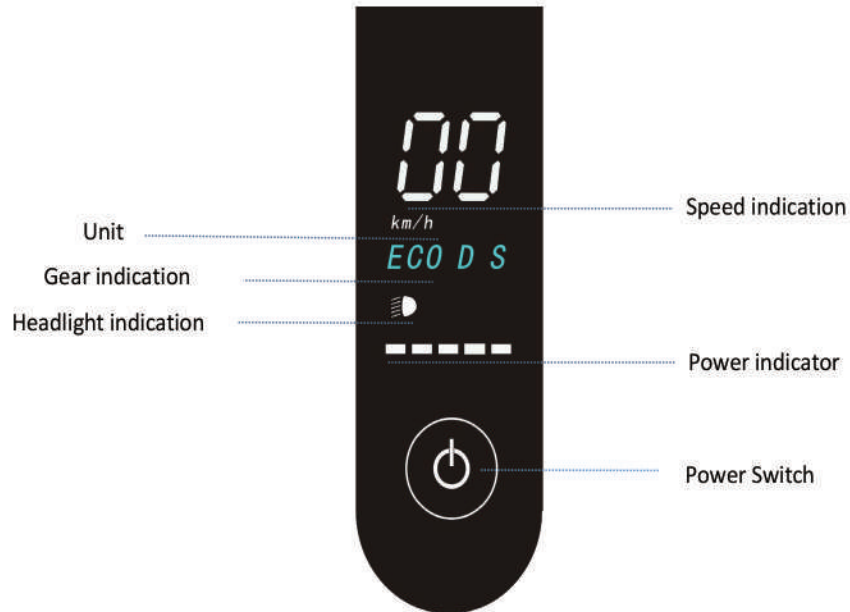

2. Operating instructions

Power on and off

Press and hold the power button for 2 seconds, the meter lights up and turns on (as shown in Figure 5.2.1), and press and hold the power button for 2 seconds while the meter turns off in the power-on state.



5.2.1

3. Headlight start and shut off

In the power-on state, press the power button twice in quick succession, the instrument front light indicator will light up (as in Figure 3.1.1), then the front and rear lights will start to light up at the same time, in the lighted state, press the power button twice in quick succession, the instrument front light indicator will go out, and the front and rear lights will go out.

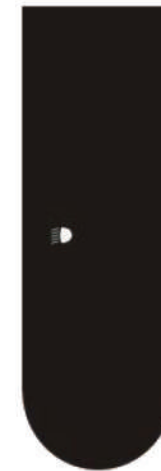

5.3.1

4.Switching gears

The meter is set up with three gears ECO-D-S. By pressing the power button once briefly,you can switch between ECO-D-S gears for different speed experiences (as shown in figures 5.4.1-5.4.2-5.4.3).



5.4.1



5.4.2

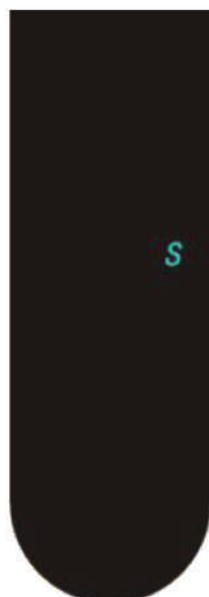

5.4.3

5.Power indicator

The instrument power display, 5 cells for a full state of charge (as in Figure 5.5.1),when the power is 1 cell the vehicle should be charged in time.

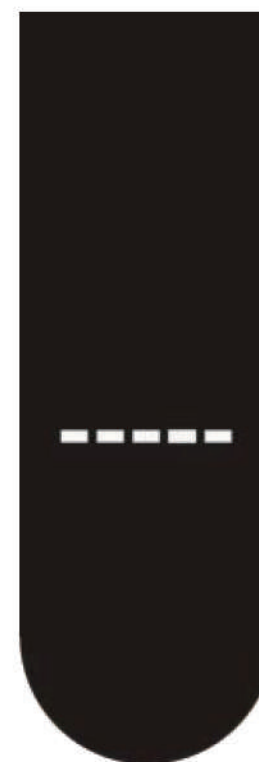

5.5.1



ENGWE is a registered trademark of ENGWE Technologies Co., Ltd; ENGWE is a registered trademark of ENGWE Technologies Co., Ltd; Android is a trademark of Google; App Store is a logo of Apple Services; other trademarks mentioned herein are the property of their respective owners. When printing this manual, as many feature descriptions and explanations as possible were included. However, due to continuous improvement of product features and design changes, it may still not correspond to the product you purchased. Due to product updates, the actual product may differ from the color and appearance mentioned in this manual. Please refer to the actual product.

ENGWE Technologies Co., Ltd. All rights reserved.

Manufacturer: ENGWE Technology Co.

We recommend that you:

1. Please read this user manual carefully before riding.
2. Do not allow others to ride this scooter if they have not read this manual correctly.
3. Please read this manual carefully. All parts of the scooter must be installed correctly according to the instructions. Also, make sure that the installation is not too loose or too tight to avoid damage or failure.
4. In order to minimize the risk, please purchase insurance in time after the purchase of the product.
5. Before riding, check the state of the installation, wheel performance and battery condition according to the instructions in the manual. Mark to ensure that the scooter is in proper condition and that there are no signs of looseness or damage to any parts. If there are any abnormal signs, please stop riding immediately and contact after-sales for inspection and guidance.



6. You are obligated to be aware of all relevant laws, regulations and policies regarding scooter riding in your area and to strictly comply with the applicable laws, regulations and policies.

7. The data and parameters of the scooter vary from model to model. It is subject to change at any time without notice.

8. To the extent permitted by law, ENGWE reserves the right to interpret and explain this statement. The laws of the People's Republic of China shall apply to this statement. It causes or may cause. There is compensation, liability, loss, ENGWE does not assume liability. Riders are responsible for any unforeseen or ongoing risks encountered during the course of the ride. Thank you again for your choice and trust in ENGWE.

Warranty policy

Dear Customer!

Thank you for purchasing ENGWE series products!

Warranty Service: Please go to the official website to check Engwe's warranty policy.

Official website: <https://engwe-bikes.com>

After purchasing Engwe products, if you have any quality problems, please contact Engwe after-sales service: service@engwe-bikes.com

- Please provide order number, purchase interface, motor number picture, and problem video.