

LANKELEISI

E-BIKE USER MANUAL



ATTENTION

Please read this manual carefully before using the lankeleisi electric bicycle. If you do not understand this information, or if you do not cover the issues covered in this manual, please contact the dealer.



WELCOME TO LANKELEISI

THANK YOU FOR CHOOSING LANKELEISI E-BIKES

Welcome to your new lankeleisi E-Bike! You are entering a new world of ease, luxury, and mobility. Whether you're looking for an environmentally friendly alternative to your regular gas-powered vehicle, a fun way to avoid traffic congestion, or simply want to spend more time outdoors, we hope you enjoy your new E-Bike. In a life full of headwinds and tailwinds, it is our honor to be the wind at your back.

If you have questions or comments, please don't hesitate to contact us:

Email: ming@lklsebike.com

web: lklsebike.com

VEHICLE IDENTIFICATION NUMBER / SERIAL NUMBER

FOR YOUR RECORDS

For future reference, please fill in the important information below. Your serial number can be found on the inward-facing surface of the frame seat stay or on head top tube.

Please retain your sales receipt for any possible warranty or loss claims.

MY LANKELEISI SERIAL NUMBER:



FOR YOUR RECORDS

MY LANKELEISI E-BIKE

Name

Address

Purchase Date

Purchase Channel

LANKELEISI WEBSITE **AMAZON** **EBAY** **OTHER**

Model

Color

Serial #

LANKELEISI E-BIKES

TABLE OF CONTENTS

| | |
|------------------------------|----|
| ABOUT THIS MANUAL | 05 |
| IMPORTANT SAFETY INFORMATION | 06 |
| ASSEMBLY INSTRUCTIONS | 09 |
| OPERATIONAL INSTRUCTIONS | 17 |
| RECHARGING THE BATTERY | 22 |
| BATTERY AND CHARGER CARE | 24 |
| GEARS | 25 |
| LED DISPLAY & KEYS | 26 |
| BRAKES | 27 |
| TIRES & INNER TUBES | 28 |
| TROUBLESHOOTING | 29 |
| LANKELEISI E-BIKES FAQs | 30 |
| INSPECTION AND MAINTENANCE | 32 |
| WARRANTY | 34 |

01 ABOUT THIS MANUAL

This manual was written to help you get the most performance, comfort, enjoyment, and safety when riding your new lankeleisi E-Bike. The manual describes specific care and maintenance procedures that help protect your warranty and ensure years of trouble-free use. Please pay particular attention to the section on battery charging and maintenance.

It is important for you to understand your new lankeleisi

E-Bike, its features, and its operation, so you get maximum enjoyment with maximum safety. By reading this manual before you go out on your first ride, you'll know how to get the most from your new lankeleisi E-Bike.

It is also important that your first ride on a new lankeleisi E-Bike is taken in a controlled environment, away from cars, obstacles, and other cyclists.

02 IMPORTANT SAFETY INFORMATION

Cycling can be a hazardous activity even under the best of circumstances. Proper maintenance of your lankeleisi E-Bike is your responsibility, as it helps reduce the risk of injury. This manual contains many warnings about the consequences of failure to maintain or inspect your

lankeleisi E-Bike. Improper use could result in serious injury or death.

We recommend you use a trusted professional bike technician to assemble your lankeleisi E-Bike.

IMPORTANT SAFETY INFORMATION

A. ALWAYS WEAR A HELMET

Helmets significantly reduce the number and severity of head injuries. Always wear a helmet that complies with your state laws when riding your lankeleisi E-Bike. Check with your local police department for requirements in your community. Make yourself more visible by wearing bright reflective clothing. Keep your reflectors clean and properly aligned. Use head and tail lights in reduced lighting conditions. Wear sturdy shoes and eyeprotection. Also check your state laws concerning other protective gear that may be required when riding your lankeleisi E-Bike.

B. KNOW YOUR LANKELEISI E-BIKE

Your new lankeleisi E-Bike incorporates many features and functions that you may be unfamiliar with. Read this manual thoroughly to understand how those features enhance your riding pleasure and safety.

C. RIDE WITHIN YOUR LIMITS

Take it slow until you are familiar with the riding conditions, as traction can be greatly reduced and brakes become less effective. Never ride faster than conditions warrant or beyond your riding abilities. Remember that alcohol, drugs, fatigue, and inattention can significantly reduce your ability to make good judgments and ride safely.

D. KEEP YOUR E-BIKE IN SAFE CONDITION

For your safety and enjoyment, and to ensure a long life for your lankeleisi E-Bike, inspect and maintain your E-Bike regularly. Follow the inspection and maintenance guidelines throughout this manual. Check critical safety equipment before each and every ride.

| COMPONENT OR CONDITION | INSPECT BEFORE EVERY RIDE | INSPECT PERIODICALLY* | CLEAN AND/OR LUBRICATE | ADJUST/TIGHTEN | REPAIR/REPLACE IF NECESSARY |
|-------------------------------------|---------------------------|-----------------------|------------------------|----------------|-----------------------------|
| Tire pressure (35-65psi) | X | | | X | |
| Tire wear/damage | X | | | X | |
| Brake pad adjustment | X | | | X | |
| Wheel quick release adjustment | X | | | | X |
| Head and tail lights | X | | | | X |
| Controls and displays | X | | | | |
| Seat post quick release adjustment | X | | | X | |
| Brake pad wear | | X | | | X |
| Brake cable tension/wear | | X | | X | X |
| Spoke tension | | X | | X | |
| Wheel true | | X | | X | |
| Hub bearings | | X | X | X | |
| Chain lubrication | | X | X | | |
| Derailleur adjustment | | X | X | X | |
| Reflectors | | X | | | X |
| Battery and charger | | X | | | X |
| Headset adjustment | | X | X | X | |
| Bottom bracket adjustment | | X | X | X | |
| All bolts, nuts & mounting hardware | | X | | X | X |

*Every 5 to 10 rides depending on length and conditions of ride.

03 ASSEMBLY INSTRUCTIONS



PART 1: REMOVE PACKAGING

Prompt:

Please read the installation steps before installation,
and install according to the installation pictures and
texts



01

Gather necessary tools.

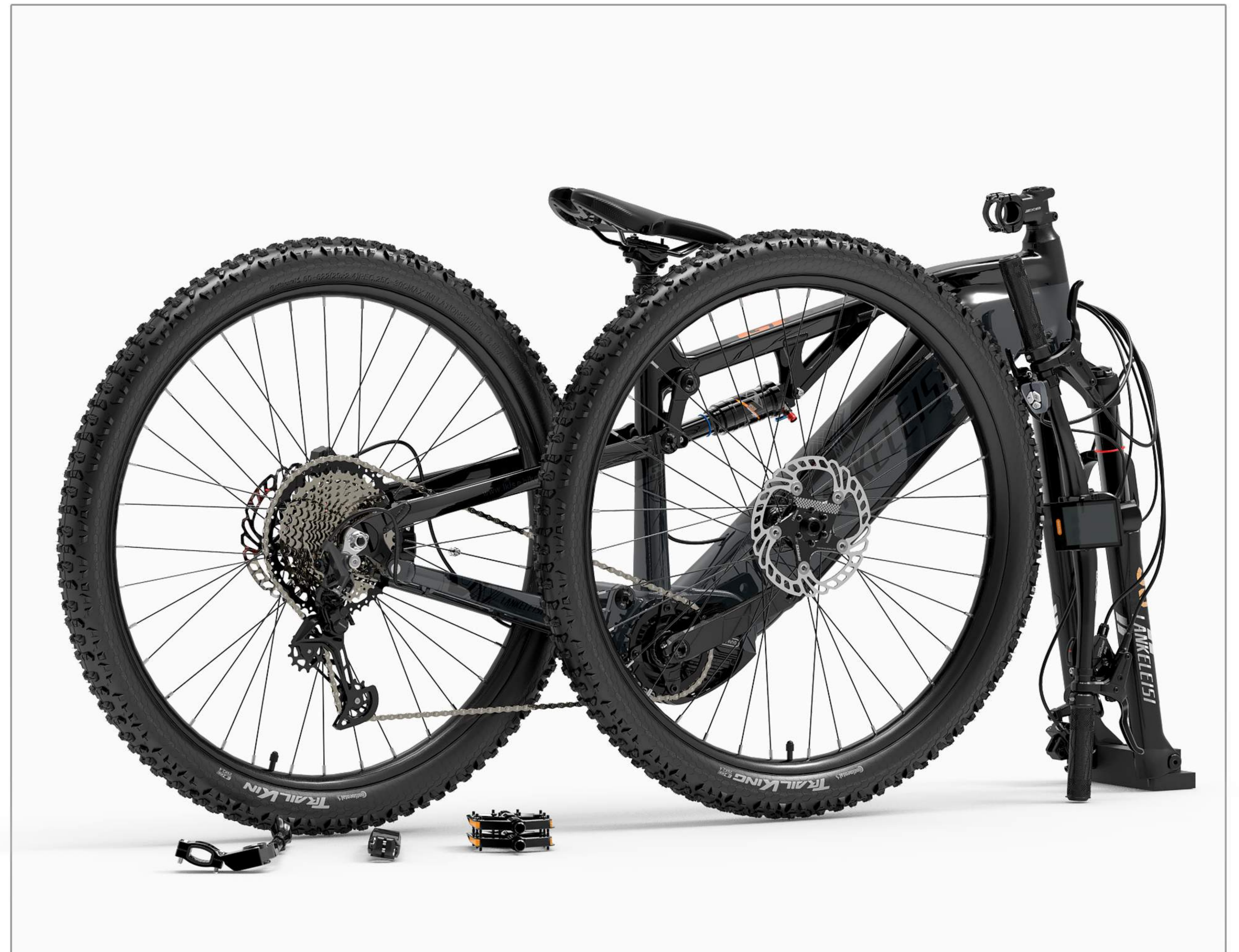

02

Unpack the LANKLEISI electric bicycle, take out the electric bicycle and accessories

PART 2: HANDLEBAR ASSEMBLY



01

Loosen the riser sides A, B screws

*Before installation, pay attention to the front and rear brakes always on the same side



02

Fix the front shock absorber and rotate the riser 180°



03

Tighten the side A, B screws



04

Remove front 4 bolts from stem cover, then remove stem cover.



05

Mount handlebar onto stem, then replace stem cover and tighten all 4 bolts.



06

Adjust handlebar according to your needs, then ensure all bolts are tightened firmly.

PART 3: SIDE SUPPORT AND FRONT WHEEL INSTALLATION



01
Hold the side supports in place and tighten the screws



02
Lower the side supports and let them support the vehicle

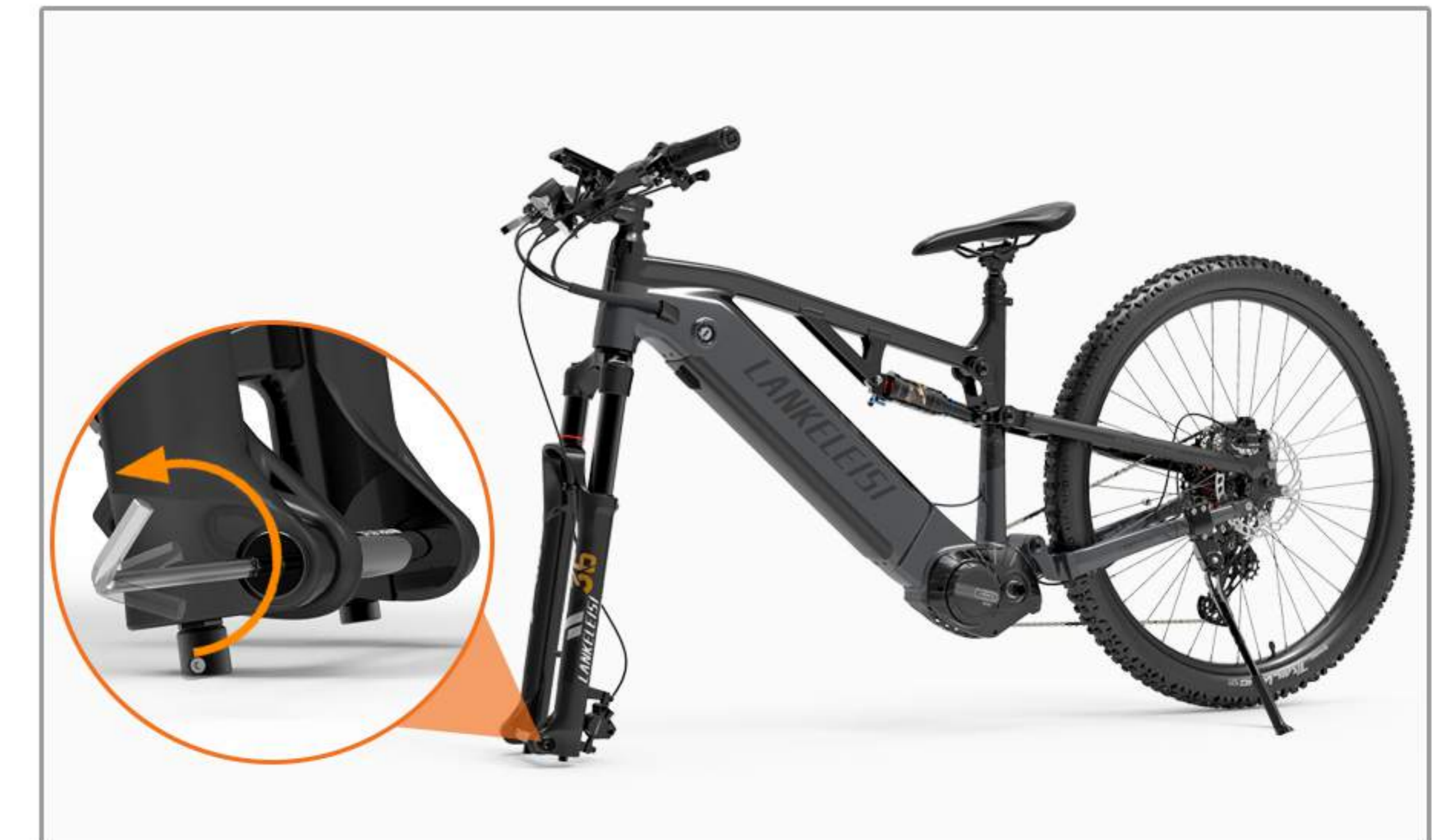

03
Loosen the front wheel mounting shaft screw and take out the mounting shaft



04
Remove the front wheel mounting shaft



05
Lift the front of the car



06
Install the front wheel centrally on the front fork

PART 3: FRONT WHEEL AND CRANK INSTALLATION

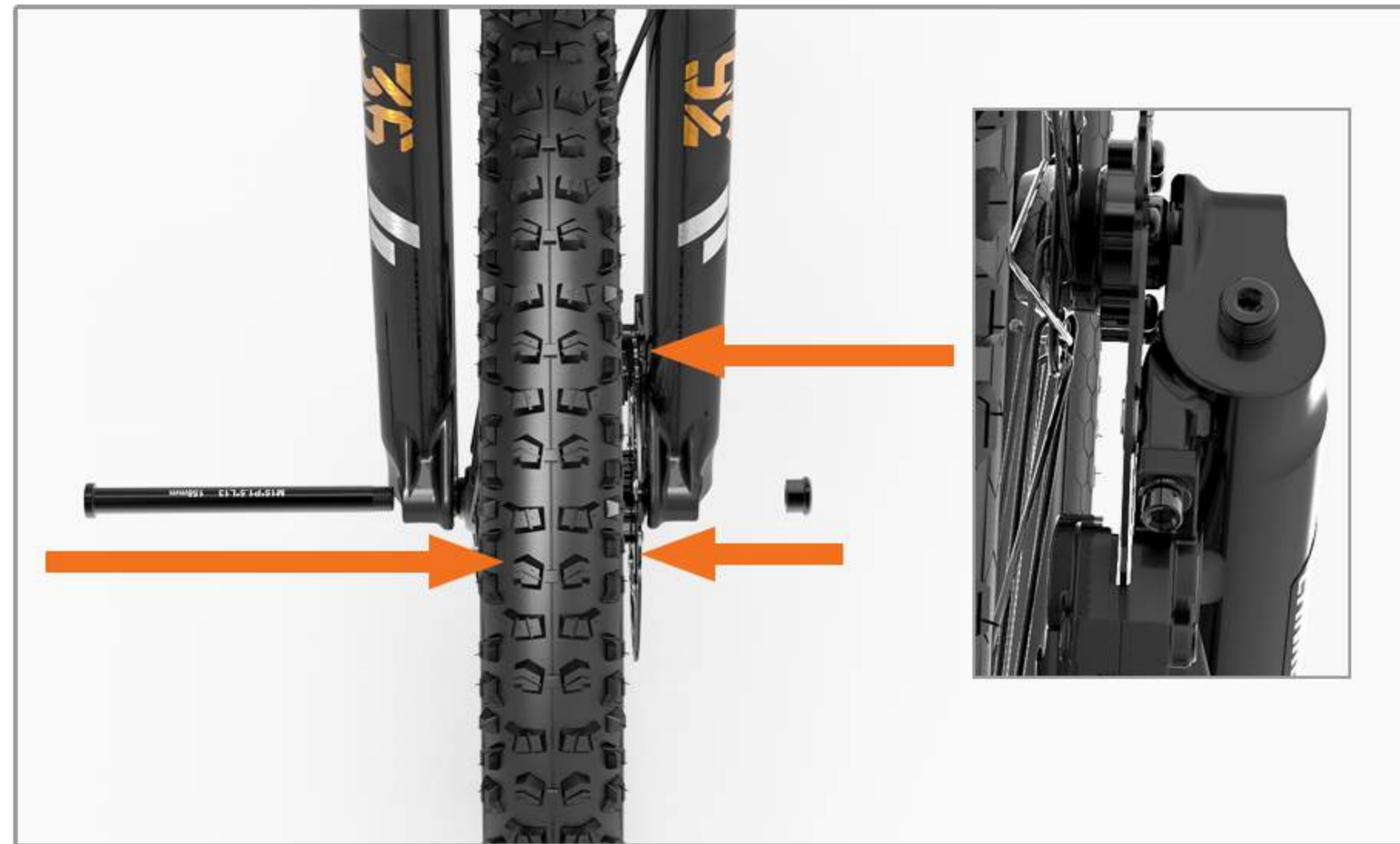
**07**

Place the wheel into the front fork and insert the mounting axle
Disc brake disc alignment clamp card slot

**08**

Tighten the front wheel mounting axle screws

**09**

Front wheel installed

**10**

Remove the crank mounting screws from the motor

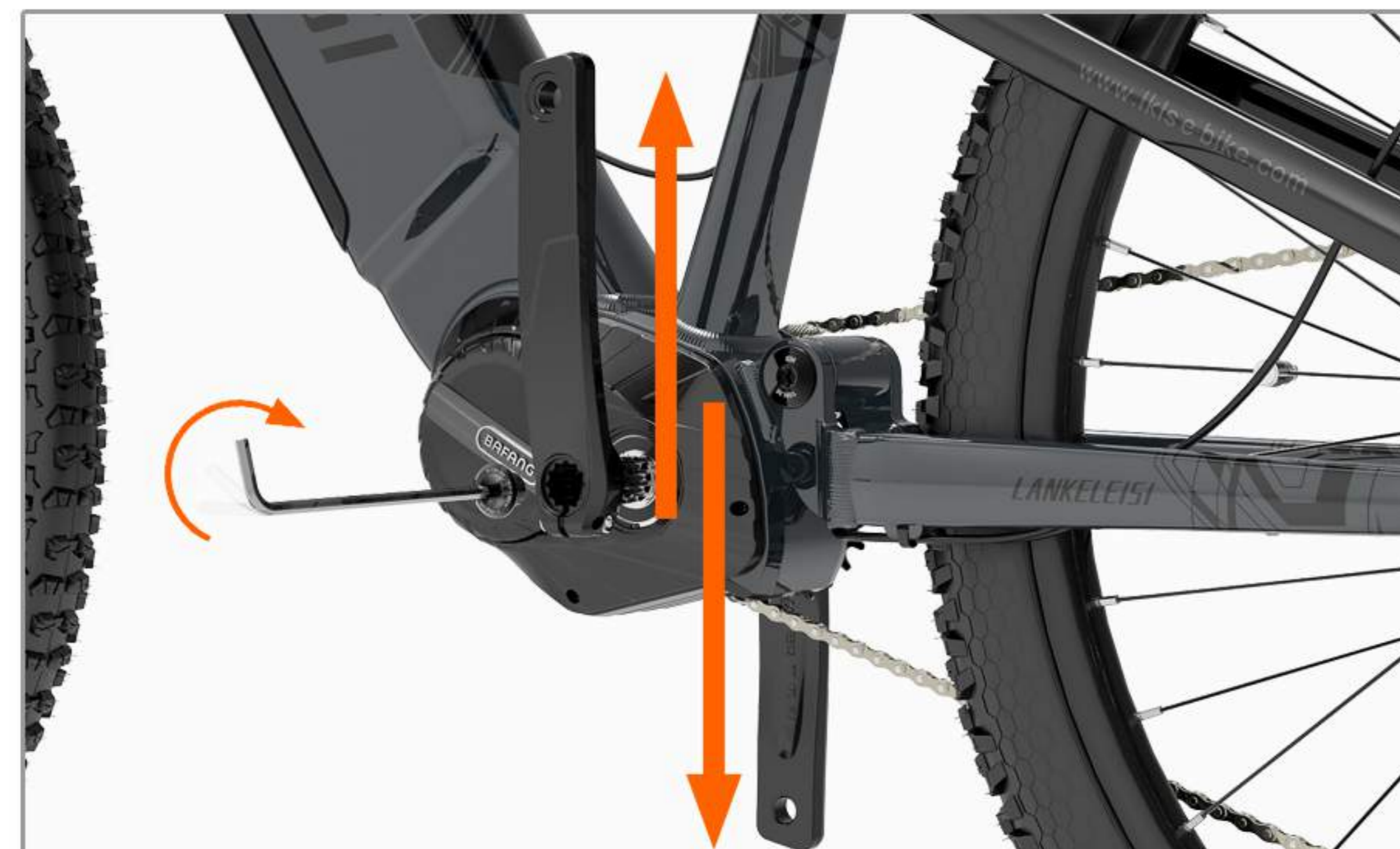
**11**

Hold the crank in the correct position and tighten the screws. , pay attention to the symmetry of the crank and the chainring.

**12**

Use the tool to tighten the upper and lower crank screws(A,B)

PART 4: PEDAL AND SADDLE MOUNTING&DIRECTION ADJUSTMENT



01

Determine the left and right pedals.
 "L" means the left side is mounted on the crank
 "R" means the right side is mounted on the chainring



02

"L" pedal is fixed counterclockwise to the crank



03

"R" pedal is fixed clockwise and fixed on the chainring



04

Press and hold the lifting seat post adjustment button to adjust the seat post height



05

When there is no pressure on the seat post, the seat post will automatically rise.
 A: When sitting on the saddle or applying pressure to the saddle, the saddle automatically lowers

PART 5: INSTALLING AND REMOVING THE BATTERY



Installing the battery

Insert the battery into the socket, press it up with both hands (making a clicking sound), and insert the battery

Notice

- 1: Turn the key when taking out the battery, the battery will automatically pry up.
- 2: 2: Rotate the second lock of the battery, After lifting the battery, remove it with both hands

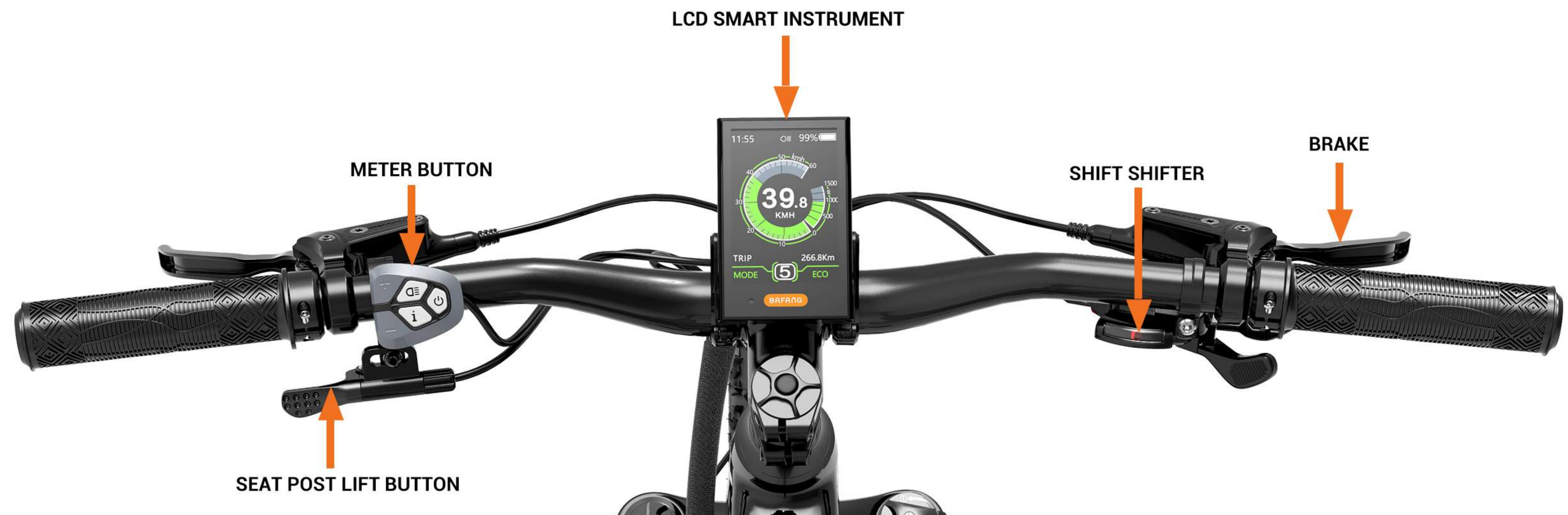

04 OPERATIONAL INSTRUCTIONS



PART 1: LCD METER FUNCTIONAL AREA DISTRIBUTION

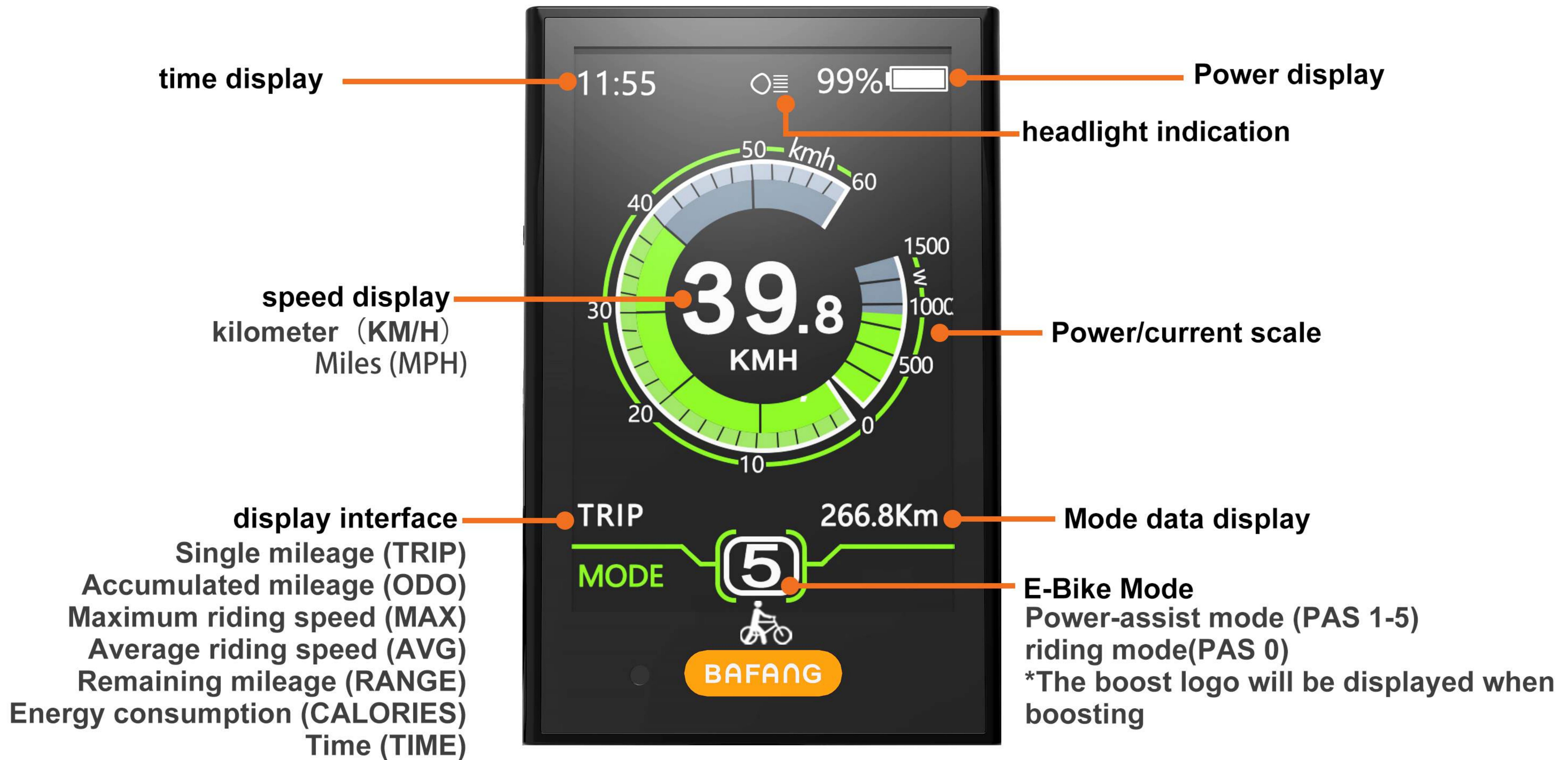



PART 2: LCD METER KEY GUIDE



The button positions and combinations are shown in the following figure:



Key operations include short press, long press, and long press key combination. Details are as follows:

1. Long press the  key to power on/off the E-bike
(*If the electric vehicle is not used for more than 5 minutes, the LCD meter will automatically shut down)
2. Short press **i** to switch the mileage and speed display information, single mileage (TRIP) → accumulated mileage (ODO) → maximum riding speed (MAX) → average riding speed (AVG) → remaining mileage (RANGE) → Energy consumption (CALORIES) → time (TIME). The energy consumption unit CALORIES represents kCal (kilocalories). When the meter reads that the sensor model is a torque
3. Short press "+" or "-" to switch the assist gear and change the motor assist power, from the lowest gear 0 to the highest gear 5. 0 gear default riding mode

4. Press the  button to turn on the headlights, Pressing off again, the LCD instrument backlight dims when the headlights are turned on, and returns to brightness when the headlights are turned off. (The headlight will automatically turn on when there is insufficient light, such as at night.)

5. Click the "-" sign until you reach the boost mode gear after zero gear, and the vehicle enters the boost preparation state, and the gear position displays ; press and hold the "-" sign again, and the vehicle enters the boost state.  flashes at 2Hz. Release the "-" sign and the vehicle will exit the boosting state and return to the ready state. At the same time, the icon will stop flashing. If there is no button operation within 5 seconds, it will automatically return to the zero position, that is, it will exit the boosting mode.

In boost mode, the vehicle's traveling speed must be less than 6km/h. The speed value displayed by the instrument comes from the controller. If the instrument does not receive the speed value sent by the controller in boost mode, it will display 2.5km/H.

6. When the electric control system of the electric bicycle fails, the instrument will automatically display the error code.

The detailed error code definition is shown in the following table:

| | | | |
|-------------|-------------------------------|----------------|-------------------------------|
| ERR0R 07 | voltage protection | ERR0R 12/13 | Battery or controller failure |
| ERR0R 08 | Motor failure | ERR0R 22/25 | Torque sensor failure |
| ERR0R 10 | Motor temperature is too high | ERR0R 21/26 | Communication failure |

PART 3: PARAMETER SETTING

1. Personalized parameter setting steps:
Operation process in the setting interface:

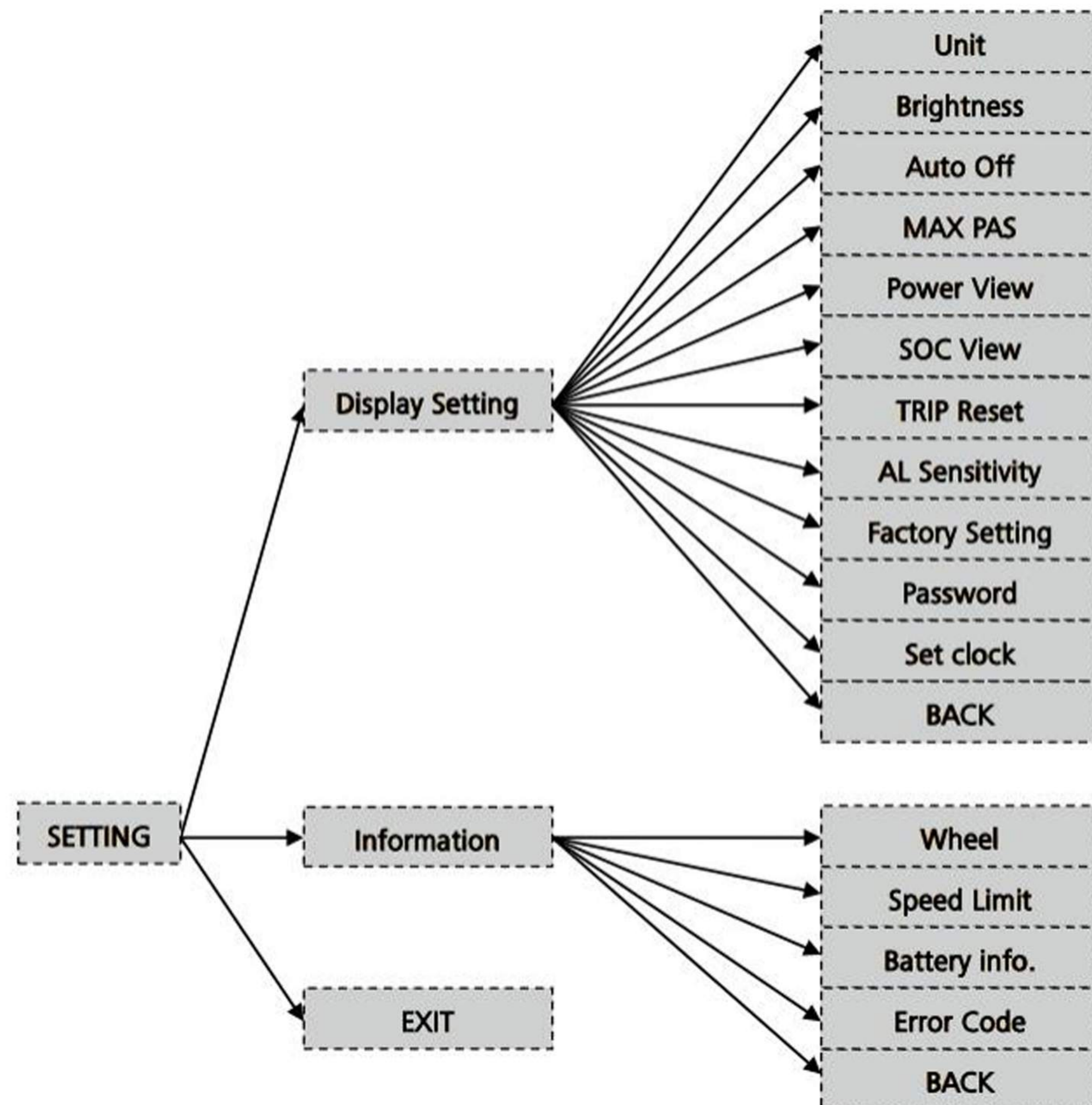

Enter the "SETTING" interface:

In the power-on state, short press (i) 2 times continuously, the system will enter the "SETTING" interface.

This interface contains three options: "Display setting" "Information" "EXIT". Short press (+) and (—) to switch options, short press (i) to confirm and enter the options. Directly select "EXIT" and short press (i) to exit the interface or short press (i) 2 times in any setting interface. You can exit the setting interface. These two exit methods can save the setting data. In addition, if you do not perform any operation for 20 seconds, you will exit the setting interface. This exit method does not save the setting data.

Enter the "Displaysetting" interface:

In the "SETTING" interface, select the "Displaysetting" option by short pressing (+) and (—) and then press (i) to confirm and enter. This page has 11 settings.

1."unit option setting-kilometer/mile unit switching
Select "unit" by short pressing (+) or (—), short press (i) to enter settings, and then press (+) or (—) to select "Metric" (kilometers) / "Imperia (miles)". Short press (i) to save and exit to "unit", short press (i) twice in succession to exit to the main interface or exit to the main interface through "BACKEXIT" "EXIT".

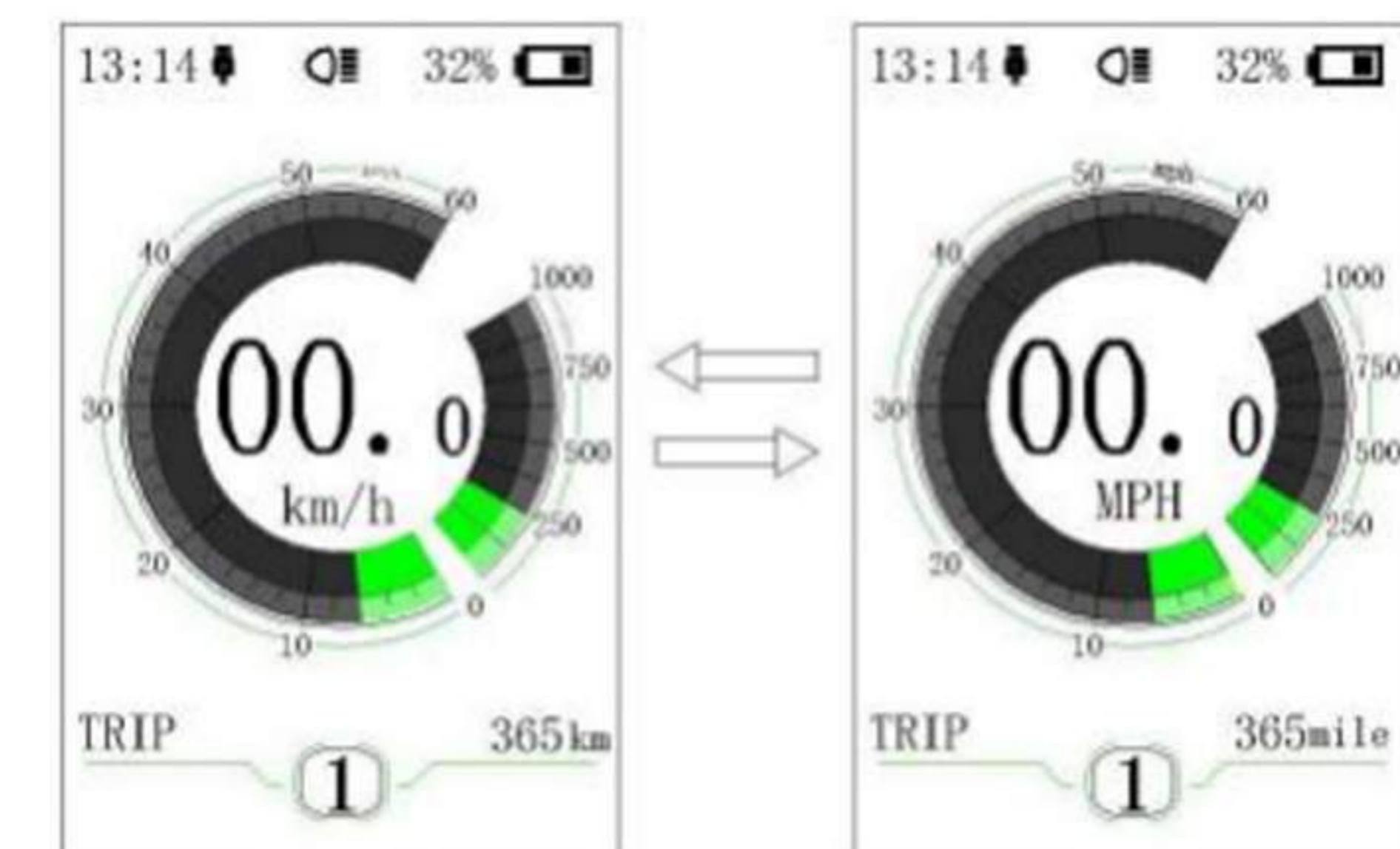

2. service" prompt function setting. Turn on or off the service prompt function. Select "ON" (open)/"OFF (closed)"

3. "Brightness" option setting - display brightness setting. Switchable percentages are "100%"/"75%"/"50%"/"30%"/"10%". 100% corresponds to the highest brightness, and 10% corresponds to the lowest brightness.

4. "Autooff option setting - automatic shutdown time setting. Switchable shutdown time OFF" / "9" / "8" / "7" / "6" / "5" / "4" / "3" / "2" / "1" The unit is min.

5. "MAX PAS" sets the riding gear. The default is 5 levels. (Note: This option is not adjustable)

6. "powerview" option setting Output display mode setting. The output display mode can be switched "power (power display)/ "current (current display)".

7. "socview" option setting. Battery display mode setting. The output display mode can be switched to "percent (percent display) / "voltage (voltage display)".

8. The "TRIPReset" option sets the single mileage clearing function setting. You can switch between "NO (not cleared)" and "YES (cleared)". The cleared data includes maximum speed (MAXS), average speed (AVG), single mileage (TRIP).

9. "ALSensitivity" option sets the light sensitivity function setting to switch the light sensitivity level "0" / "1" / "2" / "3" / "4" / "5" / "OFF", where "OFF" means off. This function, from "1" to "5" corresponds to the light sensitivity from weak to strong.

10. "password" option setting-power-on password setting function: Select the "password" option by short pressing (+) and (—) and then press (i) to confirm. At this time, short press (+) and (—) to select "start password" and then press (i) again to confirm. Short press (+) and (—) can switch "OFF" / "ON(Open)", the following is the specific switching method;

Turn on the password: Select "ON" in the "startpassword" interface and short press (i) to confirm. The interface prompts to enter the password. At this time, short press (+) or (—) to switch the numbers "0-9", short press (i) Switch the digits. After the input is completed, the interface prompts you to enter the password again. After the two inputs are consistent, the system prompts the password to be set successfully. If the two inputs are inconsistent, you need to repeat the first step to enter the new password and confirm. After the password is set successfully, the 2S interface automatically jumps to Original setting interface, short press (i) twice in succession to exit to the main interface or

exit to the main interface through "BACK" → "EXIT".

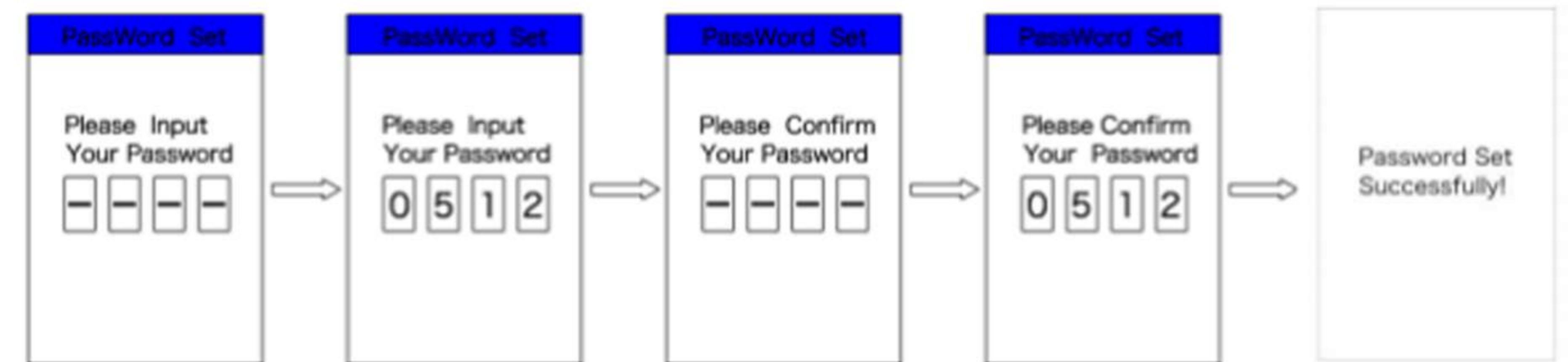

Modify password: When the password is enabled, the "Reset password" option will be added to the "password" interface. Short press (+) and (-) to select "Resetpassword" and then press (i) again to confirm. At this time, the interface prompts to enter the current Password, the instrument will automatically shut down after entering the wrong password 10 times. After the password is entered correctly, the interface will prompt you to enter a new password. The subsequent operations will be consistent with the new password.

Turn off password: Select "OFF" in the "start password" interface and short press (i) to confirm. At this time, the interface prompts you to enter the password. After entering the same password incorrectly 10 times, the instrument will automatically shut down. After the password is entered correctly, the interface prompts the password function to turn off. success.

11. "setclock" option setting time setting function Select the 24-hour time by short pressing (+) and (-), the cursor stays on the first digit of the clock, short press (+) or (-) to select "0-2", short press (i) to confirm and The cursor switches to the second digit of the clock, short press (+) or (—) to select "0-9", short press (i) to confirm and the cursor switches to the first digit of the minute, short press (+) or (—) to select "0-5", short press (i) to confirm and switch the cursor to the second digit of the minute, short press (+) or (-) to select "0-9", short press (i) to save and exit to "setclock".

"Information" interface:

"All contents in the Information interface are only for viewing and cannot be changed through the instrument itself.

| Information | |
|--------------|--------|
| Wheel Size | 27" |
| Speed Limit | 25km/h |
| Battery Info | > |
| Ctrl Info | > |
| Display Info | > |
| Torque Info | > |
| Back | |

05 RECHARGING THE BATTERY

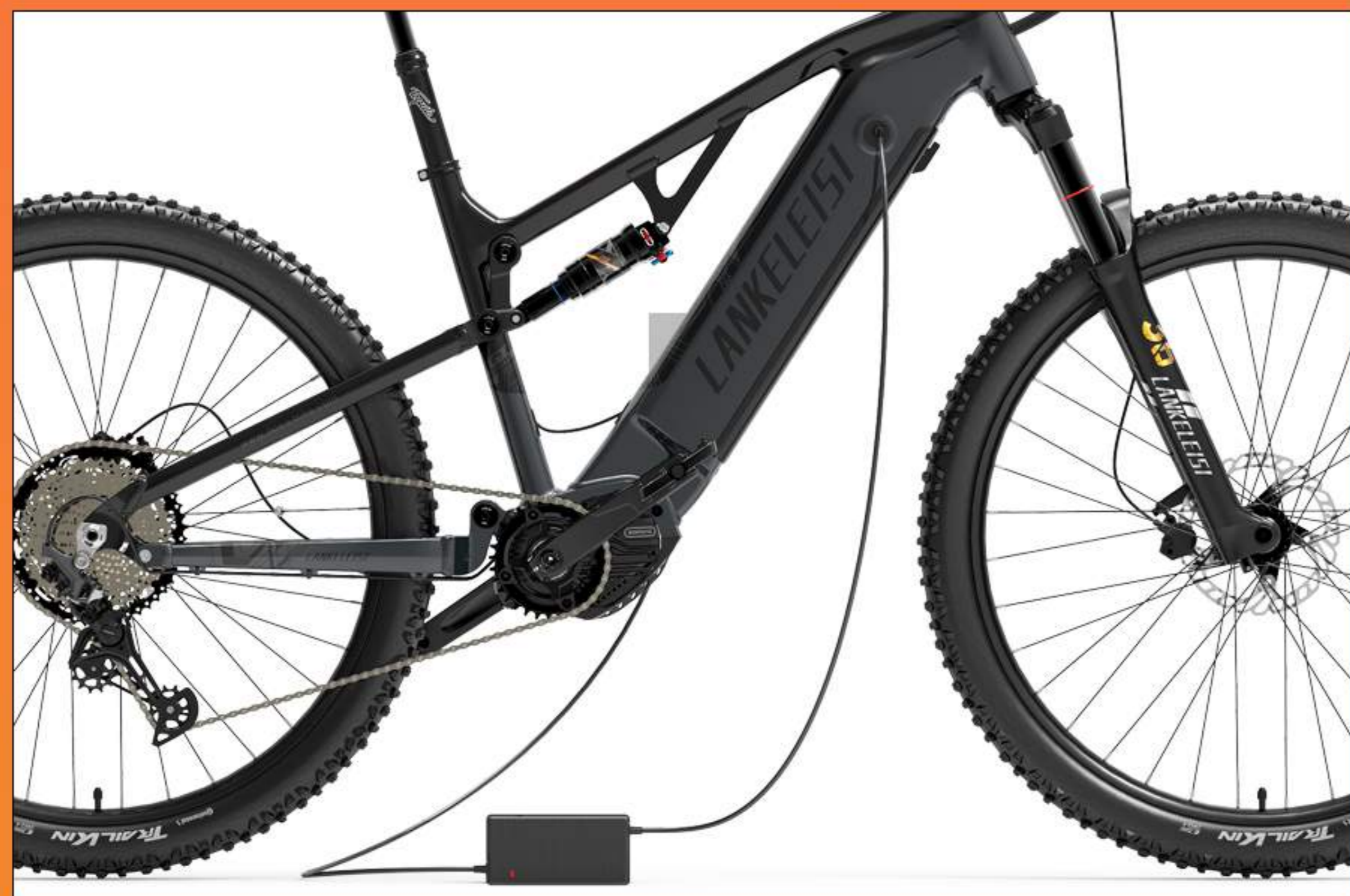

A. Recharge the battery on E-Bike directly

OR



B. Remove battery from the E-Bike and recharge separately

RECHARGING THE BATTERY

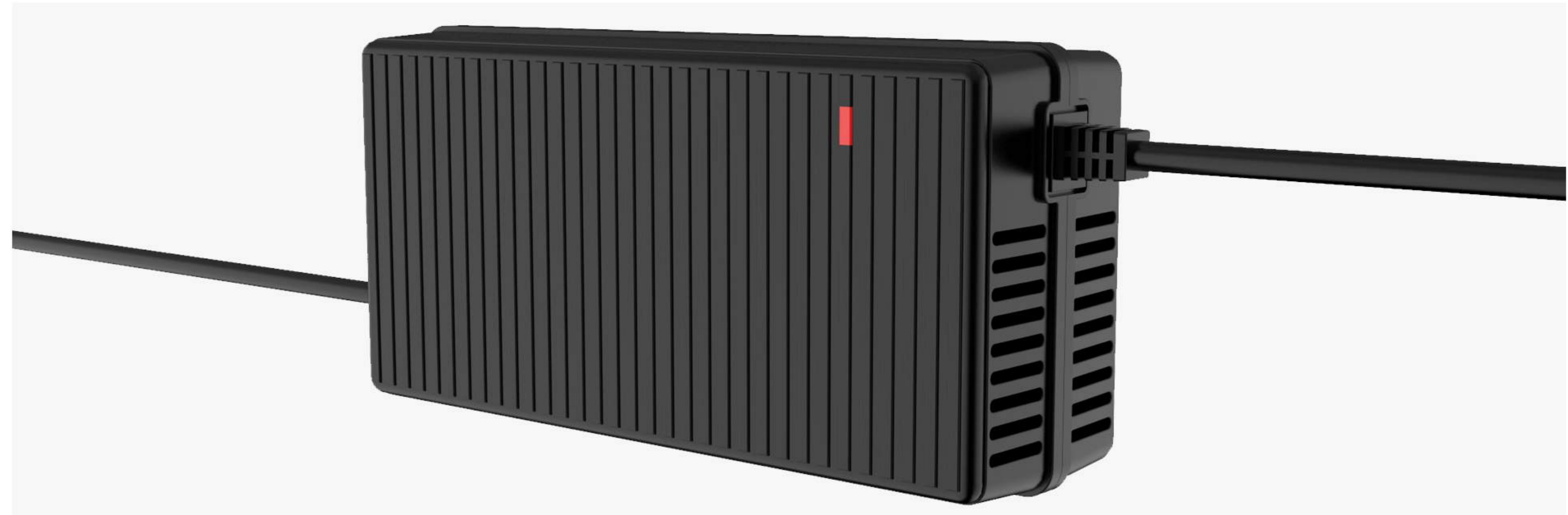

ATTENTION

Connect the battery first, then connect the power supply and make sure the red LED of the charger is lit. The charger will charge the completed battery within 5 to 7 hours.

A red light indicates that the battery is charging. A green light indicates that the battery is fully charged.

06 BATTERY & CHARGER CARE

If the battery will not be used for an extended period of time, charge it fully and recharge it every 1 months.

Store in a cool, dry place. Recharge the battery before it becomes completely discharged.

Do not use it to power other electrical devices. Improper use of the battery will damage the battery and shorten its useful life and may cause fire or an explosion. If you experience unusual sounds or odors coming from the charger or the battery, unplug charger immediately and contact lankeleisi customer service

Recharge battery after every use.

Do not disassemble or alter the battery or battery charger. Do not place the battery near fire or corrosive substances. Do not allow any liquids on or inside the battery/charger. Do not expose the battery/charger to extreme weather conditions.

Do not operate the battery/charger if damaged. Recharge the battery only with a charger specified by the manufacturer.

Do not use the battery/charger for any use other than its intended purpose.

07 GEARS

Your lankeleisi E-Bike is equipped with multiple speeds. The first gear is for easier and uphill pedaling, and the last gear is for maximum speed on level or downhill terrain. Change gears only while pedaling.

The rear wheel contains seven or nine chain sprockets (depending on model). When the chain is around the largest sprocket, you are in 1st gear, or the lowest gear. The high gear will have the derailleur positioned so that the chain is directed around the smallest gear. Every

position on the gear selector should cause a gear change. Adjustments require fine tuning and should only be made by a qualified technician.

Avoid changing gears very rapidly from first gear to the last gear or vice versa. If you change multiple gears too quickly, you could cause the chain to come off the sprocket.

08 LED DISPLAY

riding mode

Power Assist System (PAS)

The idle speed test yielded the following data:

PAS 0: Pure riding mode (no power)

PAS 1: Low speed level, ≤ 19 KM/H

PAS 2: Medium speed, ≤ 25 KM/H

PAS 3: high speed, ≤ 28 KM/H

PAS 4: Very high speed level, ≤ 33 KM/H

PAS 5: Maximum speed level, ≤ 38 KM/H

To ride in power assist mode, set the LED display to PAS 1-5. In this mode, you can use the foot pedals and the power assist system will kick in

The speeds listed here are for reference only. Actual speed will be affected by rider weight, temperature, road conditions, slope, battery status, etc.

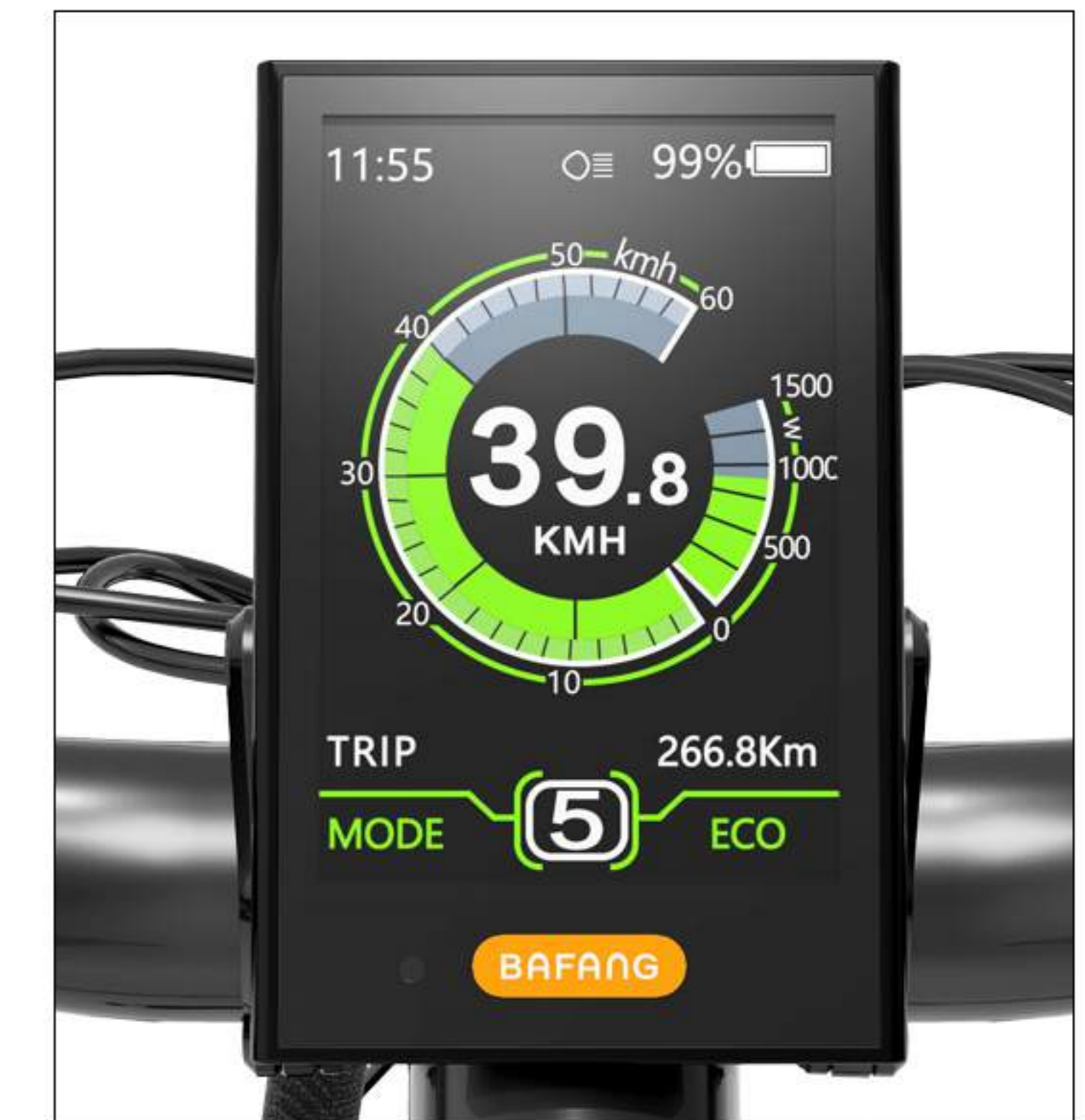

09 KEYS

Your LANKELEISI e-bike comes with a key:

- The key to the battery holder on the bicycle frame

WARNING

Keep out of reach of children. Always keep your keys in a safe place to avoid losing them.

10 BRAKES

It's important to your safety that you instinctively know which brake lever controls which brake. On your lankeleisi E-Bike, the right brake lever controls the front brake. The left brake lever controls the rear brake.

Your lankeleisi E-Bike is equipped with disc brakes for maximum reliability. Applying hand pressure to the brake levers will cause the wheel brake to create friction against the brake disc, slowing the wheel. The more hand pressure applied to the brake lever, the faster the E-Bike will come to a stop.

The rear brake should always be applied before and while the front brake is applied. Applying only the front brake to slow or stop at high speeds may result in the rider being ejected from the saddle and continuing forward over the handlebars. It is best to apply even pressure to both brake levers when slowing or stopping.

Bicycles equipped with disc brakes will occasionally make a slight scraping noise when the wheels are turning without the brakes being applied. This is normal.

Make sure that the brake lever does not contact the handle bar when full hand pressure is applied (Figure 1). Brake normal state (Figure 2). A quick adjustment may be made by screwing or unscrewing the threaded barrel adjuster on the brake lever until the brakes are fine-tuned for safe, just adjust it close to Figure 1.

If the brakes are still not operating correctly, they may require further adjustment by an experienced bicycle mechanic.

WARNING

- Disc brake rotors become hot during use. Do not touch or come in contact with the disc rotor shortly after use.
- Wet weather will require a longer distance to stop. Brake earlier and avoid sudden stops when riding in wet conditions.



FIGURE 1



FIGURE 2

11 TIRES & INNER TUBES

Tires should not be deflated unless necessary. To minimize tire wear and for maximum riding safety, comfort, and handling, maintain recommended tire air pressure. This can be found on the side wall of all tires. Use a reliable

tire air pressure gauge to check for proper inflation before every ride. At the same time, inspect tires for excessive wear and cracks. Replace tires if necessary.

12 APPEARANCE

Periodically clean your lankeleisi E-Bike with a damp cloth. Avoid spraying the lankeleisi with a water hose to avoid electrical issues. Store your lankeleisi in a dry, sheltered area away from direct sunlight and wet or damp environments.

It is also recommended to apply chain lube (such as Tri-Flow or ProLink) to the drivetrain of your E-Bike when you clean it up or wipe it down to keep it in good running condition.

13 TROUBLESHOOTING

If your lankeleisi E-Bike is not working, check the Quick Disconnect fittings to make sure they did not come loose or unplug

Simply unwrap the black spiral wire covering until the Quick Disconnect fitting is exposed, unplug and re- plug the Quick Disconnect fitting(s).



14

LANKELEISI E-BIKES FAQ

Q. How long does it take to fully charge the battery?

A. It depends on the state of depletion, but around 3-6 hours if completely discharged.

Q. Can I ride up hills and against strong headwinds on my lankeleisi electric bike?

A. Yes. One of the main advantages of cycling on a lankeleisi electric bicycle is that it flattens hills and increases your average speed when tackling inclines and headwinds. If you provide a reasonable amount of effort, you should be able to tackle anything from a 10% gradient up to a 14% gradient. You will be amazed at the relative ease with which your new lankeleisi electric bike can tackle some of the most arduous journeys.

Q. Do I need to pedal an electric bike?

A. No, but it helps to prolong battery life. The motor on our bikes is both throttle and pedal assist controlled, allowing you to decide how much power you desire. Have you ever tried to cycle when speeding downhill on your normal bicycle? It's just like that. The motor is propelling you faster than you're cycling, so there is pretty much no resistance. It's merely a formality!



Q. What happens when I use the brakes under powered assistance?

A. All of our bikes are equipped with brake levers that have a built-in safety switch that automatically cuts off the motor power under normal braking conditions. This not only ensures a safe unpowered stopping feature, but also protects the motor under braking conditions so that it isn't working against the brakes.

Q. How far will a lankeleisi take me?

A. This all depends on a few factors. Cycling with pedal assist along a straight road under normal conditions, the standard battery should last about 35-50 km. Cycling up steep hills will obviously take more energy out of the battery and factors such as road surface, wind resistance, weight of the rider, and tire pressure will affect your range.

Q. What happens if I get a flat tire?

A. The tires on our bikes are the same as conventional bicycles. Simply replace the tube with a tube of the right size and inflate it. No special tires or parts will be needed.

Q. How do I know when the battery is low?

A. A clearly visible indicator on the LED screen shows the amount of juice remaining. If it's getting lower and lower and you don't think you can get to your destination, you can turn off the motor and reserve it for the hard part.

Q. Do I have to wait for the battery to empty before I charge it?

A. No. The batteries we use are Lithium-ion batteries which do not suffer from 'memory effect.' This means that there is no need to discharge a battery completely before you recharge it again. You can partially recharge the battery at any time without reducing its voltage or lifespan. We recommend recharging the battery after every use, regardless of how far you rode.



15

INSPECTION & MAINTENANCE

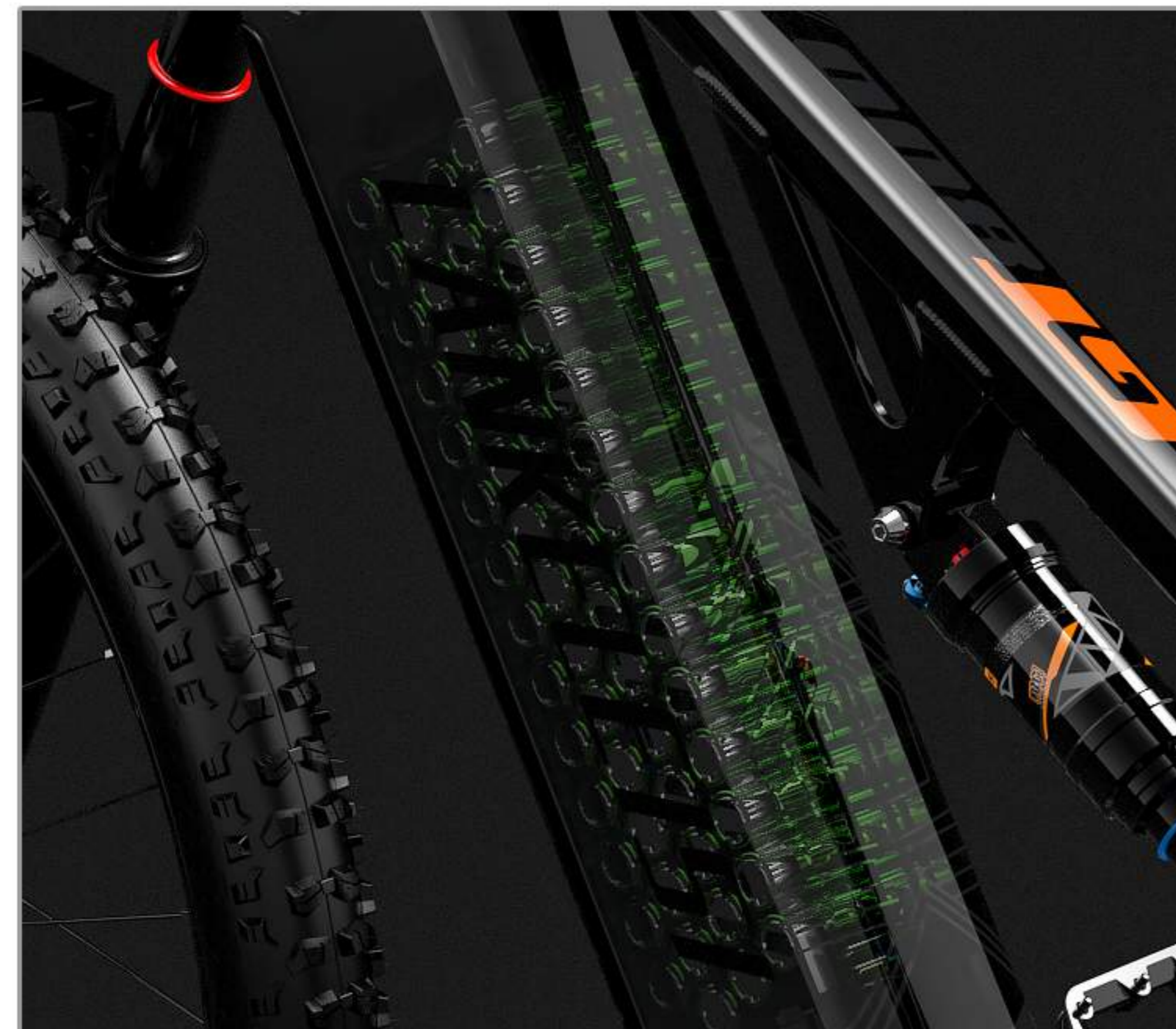

Hand brake cut-off power

When your bike is equipped with brake cut-off power set, the bike will automatically cut off power when the brake is used.

Low voltage protection

When the battery output voltage reaches its limit, the electronic control system will cut off the power to automatically protect the battery. When the battery reaches its minimum voltage, you can switch to pedal riding. The battery should be recharged before riding again.

Power off

When your E-Bike is not in use, please turn off the power.

Charge indicator

Red indicates charging, green indicates that the battery is full.

Note: The battery switch must be turned off using the switch on the bottom when the battery is charging. The battery must be fully charged before the first use. We recommend you charge the battery for a full 6 hours after your first 3 uses. If the bike is not used for a long time, you should fully charge and remove the battery. While not in use, keep the battery turned off and recharge every 2 months.

Make sure to keep the battery and charger away from children during charging.

Do not attempt to disassemble or modify the battery or charger.

Do not use the battery or charger for any use other than its intended purpose.

Battery charging

Plug in the connector between the charger and the battery, then plug the charger into an electrical outlet. The LED indicator on the charger will show red, which means charging. When the indicator light turns green, the battery is fully charged. When you are finished charging, first unplug the charger from the power supply, and then unplug the connector between the battery and the charger.

During the charging process, the charger and battery should be placed in a stable and cool place. The battery operating temperature range should be between 32 and 110 degrees Fahrenheit. Do not put any cover on the battery or charger. Make sure that no liquid comes into contact with the charger.

Mileage

Performance of electric bicycles is affected by road conditions, rider/load weight, and weather conditions. We recommend that you manually pedal as often as possible to improve your travel distance and battery life.

Inclines

When riding uphill on an incline of 15 degrees or more, we recommend using the pedal to assist your climb.

Cleaning

When cleaning your electric bicycle, wipe with a dry or damp cloth, do not spray directly with a hose. Do not put oil on the front brake.

The seat tube should be cleaned and lubricated if necessary.

Parking

Please make sure your lankeleisi E-Bike is parked in a stable place and the kickstand is used.

BASIC MAINTENANCE

1. To ensure that your E-Bike is in the best condition, maintain and clean regularly.

2. Regularly check that the tires are inflated correctly.

3. Make sure that quick release, nuts and bolts are tightened.

4. After a period of riding, check that the spoke tension is normal. Adjust as needed.

5. The frame and other parts are made of aluminum alloy. Avoid friction or collision and clean it regularly.

6. Do not take apart the motor, battery, or controller yourself. If necessary, take your E-Bike to a professional bicycle technician for repairs.

7. Do not use high-pressure water to clean your E-Bike. Keep water away from the controller, battery and motor.

8. Lubricate the chain, flywheel, head parts, kickstand, etc. when necessary.

16

WARRANTY CERTIFICATE

Important

LANKELEISI warranties against manufacturer defects for all of our regular electric bikes and parts except accessories.

The warranty period begins on the delivery date within twelve (12) months.

Please note this warranty only covers the initial purchaser and DOES NOT cover accessories.

Validity

The warranty is valid only when:

- a)The Product is purchased from LANKELEISI authorized dealers or outlets.
- b)The Product is NOT transferable to any third party either in ownership or during the period of contract.
- c)The model and serial label should not be defaced or removed from the Product.

Exclusion

The warranty is not applicable to:

- a)Damage or loss caused by modification, alteration, or repair by any unauthorized party.
- b)Damage or loss caused by mishandling by the customer or person(s) with access to the product on the customer's premises.
- c)Normal wear and tear.
- d)Damage or loss caused by Acts of God or any other causes beyond LANKELEISI's control.

e)Damage or loss as a result of external bodies.

f) Damage or loss caused by another device that is connected to the Product.

g)Damage resulting from accidents, misuse, abuse, tampering, or failure of the customer to follow normal operating procedures outlined in the user manual.

h)General maintenance and servicing.

lankeleisi E-Bike Warranty

In the rare case that your E-Bike arrives and does not work, the next course of action is repair or replacement AT MANUFACTURER'S DECISION. In order to honor the warranty the following must be followed:

- If your E-Bike is received with a defect, lankeleisi will take care of the shipping fees (at lankeleisi's instruction) and immediately ship replacement equipment or repair the equipment.
- If your E-Bike is in need of repairs, the owner must contact lankeleisi and will receive a Return Authorization (RA) Number and all of the necessary information.lankeleisi will not accept returns without an RA.
- All returns must be properly packaged to prevent damage during shipment. An explanation of the problem or damage and a proof of purchase must be submitted with the return which will be shipped by the owner.
- The RA number must be clearly visible.
- The owner will be responsible for insurance of the merchandise (at owner's cost) because lankeleisi will not be responsible for damages or losses during shipment.

The warranty is void if: The damages are a result of an accident, abuse, alteration, non-authorized usage, or use of electricity other than that indicated in this manual.

The warranty is void if: The owner or user neglected to do routine maintenance required and the damages or problems are directly related to such neglect. It is the user's responsibility to keep the E-Bike in proper condition.

Certain parts of the equipment are not covered by the lankeleisi warranty due to the fact that they require replacement after multiple uses. For example: buttons, pedals, seats, tires, etc. These parts will eventually require replacement at the owner's cost.

The manufacturers will not be held responsible for damages or monetary losses related to the purchase or use of their products. Tailwind denies responsibility for all physical and moral damages linked to the purchase and use of their products. In all cases, the damages cannot exceed the purchase price paid by the initial owner.

The final decision to honor the warranty is taken by lankeleisi personnel after a technical inspection when the owner returns defective products.

The warranty excludes:

1. Replacement and shipping costs of products worn out by normal use.
2. Replacement and shipping costs of products due to problems related to neglect, abuse, or lack of maintenance.

Warranties are NON-TRANSFERABLE.

Product Data

E-Bike Model: _____
 Serial Number: _____
 Purchase Date: _____
 Order Number: _____

LANKELEISI

DONGGUAN JIETU OUTDOOR SPORTS GOODS CO., LTD.

ADD: NO. 1, HEDONG 2ND ROAD, JINSHA, CHANG'AN, DONGGUAN, GUANGDONG, CHINA

 WWW.LKLSEBIKE.COM
