

**450 Standard / 450 Recliner
525 Standard / 525 Recliner
Bariatric Manual Wheelchair**



USER MANUAL

SAVE THIS MANUAL FOR FUTURE USE.

CONTENTS

1	INTRODUCTION	3
2	IMPORTANT SAFETY PRECAUTIONS.....	4
	WARNINGS	4
3	GETTING STARTED – SETUP AND GENERAL OPERATION GUIDELINES	6
	REGENCY 450 / 525 COMPONENT IDENTIFICATION	6
	OPERATING THE WHEEL LOCKS	6
	UNFOLDING AND FOLDING THE WHEELCHAIR	7
	UNFOLDING THE WHEELCHAIR	7
	OPENING THE WHEELCHAIR (ALL MODELS)	7
	INSTALLING THE HEADREST AND PUSHBAR (RECLINING MODELS ONLY)	8
	FOLDING THE WHEELCHAIR FOR TRANSPORTATION OR STORAGE	8
	REMOVING THE HEADREST AND PUSHBAR (RECLINING MODELS ONLY).....	9
	CLOSING THE WHEELCHAIR (ALL MODELS)	9
4	HANDLING TIPS	9
	BALANCE.....	9
	TRANSFER.....	9
	REACHING / BENDING.....	10
	REACHING / BENDING FORWARD OR SIDEWARD.....	10
	REACHING / BENDING BACKWARD	11
	RAMPS AND INCLINES	11
	ASCENT.....	11
	DESCENT	12
	CURBS	12
	CURBS – WITH ATTENDANT	12
	GOING UP (METHOD 1).....	12
	GOING UP (METHOD 2).....	12
	GOING DOWN.....	13
	STAIRS AND ESCALATORS	13
	WEIGHT TRAINING	13
5	ADJUSTMENTS	13
	REAR WHEELS & CASTERS	13
	ARMS	14
	REMOVE ARM	14
	INSTALL ARM	14
	SWINGAWAY FOOTREST / ELEVATING LEGREST	14
	SWING FOOTREST / LEGREST AWAY FOR TRANSFER.....	15
	RETURN FOOTREST / LEGREST TO OPERATION POSITION.....	15
	SWINGAWAY FOOTREST, ELEVATING LEGREST: ADJUST FOOTPLATE EXTENSION LENGTH.....	15
	ELEVATING LEGREST: RAISE LEGREST.....	15
	ELEVATING LEGREST: ADJUST CALF PAD POSITION	16
	ADDITIONAL CALF PAD ADJUSTMENTS	16
	CROSSBRACES	16
	TIGHTEN CROSSBRACES.....	16
	RECLINER (525 RECLINING MODEL ONLY).....	17
	ADJUSTING THE BACK ANGLE (525 RECLINING MODEL ONLY).....	17
	WHEEL LOCKS.....	17
	ADJUST WHEEL LOCKS.....	17
6	TRANSPORTING THE GENDRON REGENCY 450 / 525.....	18
	TRANSPORTING THE WHEELCHAIR.....	18
7	MAINTENANCE	19
	SERVICE MANUAL.....	19
	DO-IT-YOURSELF MAINTENANCE.....	19
	LIST OF TOOLS	20
	GENERAL CARE.....	20
	CHECK TIRE WEAR	20
	CHECK HANDRIMS.....	20
	CHECK WHEEL LOCK ENGAGEMENT.....	20
	CHECK ANTI-TIPPERS (STANDARD ONLY ON RECLINING MODELS).....	20
	CHECK HANDGRIPS.....	20
	CHECK CROSSBRACES.....	20
	CHECK UPHOLSTERY	21
	CHECK REAR WHEEL ADJUSTMENT	21
	CHECK ARMS.....	21
	CHECK BACKPOSTS / PUSH HANDLES	21
	CHECK FOOTRESTS & ELEVATING LEGRESTS	21
	CLEANING YOUR REGENCY 450 / 525	21
	CHECK CASTERS	22
	CHECK WHEEL BEARINGS.....	22
8	TROUBLESHOOTING.....	23
9	SPECIFICATIONS	24
10	LIMITED WARRANTY.....	25
11	INDEX.....	27



1 INTRODUCTION

Important safety, operating, and maintenance instructions that warrant your attention are included in this user manual. Read this entire manual carefully before operating your new wheelchair. Keep it handy for future reference, and refer to it as often as necessary to help maintain good performance standards.

Consult your healthcare professional and GF Health Products, Inc. (Graham-Field) authorized distributor for assistance in developing and learning safe and effective techniques for performing your daily activities according to your individual physical abilities and needs, and to make certain that your wheelchair is properly prescribed and adjusted for your use.

The safety precautions in this manual are general warnings intended to be used only as basic guidelines. You may find it necessary to develop your own methods for safely solving frequently encountered challenges. Again, consult your professional medical advisors for their recommendations about safety methods, and never hesitate to ask for their assistance.

Your wheelchair should receive frequent, regularly scheduled maintenance, including an inspection of the mechanical parts, to ensure proper operation. Some suggested inspection procedures, troubleshooting procedures, and adjustment procedures are included in this manual. When it comes to service and repair, remember that your Graham-Field authorized distributor knows your wheelchair best.

Thank you for choosing a Gendron product. We at Graham-Field wish to assure you of our continuing commitment to provide innovation and quality in our products. The Regency 450 / 525 is a manual folding wheelchair suitable for frequent users who require a portable wheelchair, fitted to their anatomy, without the need of customization or alteration to the center of gravity. The Regency 450 / 525 is intended for indoor and / or outdoor use.

The Regency 450 / 525 Recliner comes with a removable full support headrest which includes an additional neck support that adjusts easily to fit every need. A pushbar is standard. The Recliner mechanism is intended to be operated by an attendant. Anti-tippers are standard on Recliners.

The Regency 450 has a maximum weight capacity of 450 lb (204 kg).

The Regency 525 has a maximum weight capacity of 525 lb (238 kg).

The person performing adjustments on the Regency 450 / 525 has the responsibility of making certain that the user can safely operate the wheelchair with the adjustments selected. This person must evaluate the user's ability, weight, physical condition, the environment in which the wheelchair will be used, and the terrain over which the wheelchair will travel.

Please note the following special statements, used throughout this manual, and their significance:

- ⚠ WARNING: Indicates a potential hazard situation or unsafe practice that, if not avoided, could result in death or serious personal injury.**
- ⚠ CAUTION: Indicates a potential hazard situation or unsafe practice that, if not avoided, could result in minor or moderate personal injury.**
- ▲ NOTICE: Indicates a potential hazard situation or unsafe practice that, if not avoided, could result in product or property damage.**

Info: Provides application recommendations or other useful information to ensure that you get the most from your product.

2 IMPORTANT SAFETY PRECAUTIONS

⚠ IMPORTANT SAFETY PRECAUTIONS: ALWAYS FOLLOW THESE SAFETY PRECAUTIONS WHEN USING YOUR WHEELCHAIR. FAILURE TO DO SO COULD RESULT IN PERSONAL INJURY TO YOU OR OTHERS OR DAMAGE TO YOUR WHEELCHAIR.

Safety requires the constant attention of the wheelchair user and the attendant. It is extremely important to learn and always use safe methods of performing basic daily activities. Always consult your healthcare professional to determine those methods most suitable for your individual abilities.

Protect yourself and your wheelchair by having your Regency 450 / 525 serviced regularly. Whenever any part of your Regency 450 / 525 is not functioning properly, contact your Graham-Field authorized distributor immediately, as a hazardous situation could result, causing personal injury or damage to your wheelchair. **ONLY EXCELLENT CONDITION IS ACCEPTABLE WHERE SAFETY IS CONCERNED.** Periodic inspection, adjustment, and replacement of worn parts will provide many years of superb performance.

WARNINGS

⚠ WARNING:

Regency 450 maximum weight capacity is 450 lb (204 kg), EVENLY DISTRIBUTED.

Regency 525 maximum weight capacity is 525 lb (238 kg), EVENLY DISTRIBUTED.

⚠ WARNING: Do not operate this wheelchair on streets or roadways.

⚠ WARNING: Do not operate this wheelchair on hilly or rough terrain, sand, wet or icy surfaces, or surfaces with impaired traction. Ensure that pathway is clear of all obstacles.

⚠ WARNING: Do not turn wheelchair while going downhill, as wheelchair could tip over.

⚠ WARNING: Do not attempt any incline or decline greater than six degrees (10% grade, or one foot of rise or fall per ten feet of ramp length).

⚠ WARNING: This wheelchair does not offer seating or occupant restraint equivalent to the seat provided in a motor vehicle! To increase your safety while traveling in a motor vehicle, always transfer to the vehicle seat and use the restraint provided by the vehicle manufacturer.

⚠ WARNING: Do not tie down or attach anything to the wheels. This could cause tipping and possibly result in injury or damage to the wheelchair.

⚠ WARNING: The footplates' lowest point should clear the ground by at least 2 1/2 inches, to permit proper clearance of potential obstruction.

⚠ WARNING: Doing a "wheelie" (tilting the wheelchair backward until it reaches its balance point) is dangerous and could result in personal injury to the user.

⚠ WARNING: Do not stand or step on the footplates while transferring to or from your wheelchair. This could cause the wheelchair to tip or may cause personal injury or damage to your wheelchair.

⚠ WARNING: Do not wrap hand around seat edge when opening or entering the chair.

- ⚠ WARNING: When folding or unfolding the wheelchair, do not place your fingers or hands under the seat rail or between the seat rail and side panel.**
- ⚠ WARNING: Do not lift the wheelchair by the arms, footrests or legrests, or any other detachable parts.**
- ⚠ WARNING: Always engage wheel locks before transferring, using a wheelchair lift, or using an elevator.**
- ⚠ WARNING: Ensure wheelchair is on a stable, level surface and engage wheel locks before and during transfer.**
- ⚠ WARNING: Do not lean over the top of the wheelchair back. This could cause the wheelchair to tip over.**
- ⚠ WARNING: To reduce the risk of tipping before leaning or reaching forward, sit back in the seat and rotate casters fully toward front of wheelchair.**
- ⚠ WARNING: Unauthorized modification or the use of non-Gendron replacement parts could change the structure of the wheelchair, void the warranty, and create a hazardous condition resulting in serious personal injury.**
- ⚠ WARNING: Do not lean on this wheelchair or use it as a walker—these are practices which could result in loss of balance and personal injury.**
- ⚠ WARNING: Do not use your wheelchair on escalators.**
- ⚠ WARNING: Wheel locks are not brakes. Do not use the wheel locks to slow down your wheelchair, or while the wheelchair is moving. Wheel locks are only intended to keep the wheelchair in place when it is at a complete stop.**
- ⚠ WARNING: Cancer and Reproductive Harm - www.p65warnings.ca.gov.**
- ⚠ WARNING: GF Health Products, Inc. specifically disclaims responsibility for any personal injury or property damage which may occur during any use which does not comply with federal, state, or local laws or ordinances.**

3 GETTING STARTED — SETUP AND GENERAL OPERATION GUIDELINES

REGENCY 450 / 525 COMPONENT IDENTIFICATION

Familiarize yourself with main components, identified in Regency 450 / 525 illustrations below.



Regency 450 / 525 Bariatric Wheelchair, Recliner Model

OPERATING THE WHEEL LOCKS

The Regency 450 / 525 has two wheel locks — one on each rear wheel. To engage the wheel locks, push the levers forward until they lock into place. To disengage, pull back on the levers until the wheels roll freely.

UNFOLDING AND FOLDING THE WHEELCHAIR

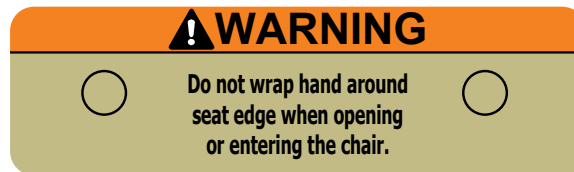

- ⚠️ **WARNING:** Read warning label, shown above, located on seat rails: Do not wrap hand around seat edge when opening or entering the chair.

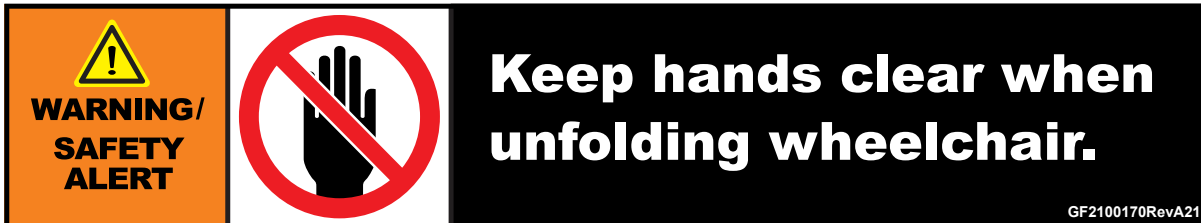

- ⚠️ **WARNING:** Read warning label, shown above, located on wheelchair arms: Do not wrap hand around seat edge when opening or entering the chair.
- ⚠️ **WARNING:** When folding or unfolding the wheelchair, do not place your fingers or hands under the seat rail or between the seat rail and side panel.
- ⚠️ **WARNING:** Do not sit on or transfer into the wheelchair unless it is fully open and the seat rails are fully seated.
- ⚠️ **WARNING:** Do not lift the wheelchair by the arms, footrests or legrests, or any other detachable parts.

UNFOLDING THE WHEELCHAIR

Opening the Wheelchair (All Models)

1. Engage wheel locks on both sides.



UNFOLDING THE WHEELCHAIR

Opening the Wheelchair (All Models)

1. Engage wheel locks on both sides.
2. Use both hands to push down with even pressure on seat tubes and seat upholstery on insides of wheelchair, as shown at above left, until the seat rails are fully seated, as shown at above right. **Do not place any fingers or parts of your hand under the seat rails.**

3. Attach footrests or legrests to wheelchair.
4. Reinstall seat cushion, if so equipped.

⚠ WARNING: Ensure seat, arms, and footrests or legrests are locked in place before occupying or operating wheelchair.

Installing the Headrest and Pushbar (Reclining Models Only)



After the wheelchair has been fully unfolded and opened:

1. Install headrest as shown at above left: slide headrest down onto headrest support assembly as shown.

⚠ WARNING: Ensure headrest is fully seated and securely installed before use.

2. Install headrest cover, shown at above right.
3. Install push bar as shown at above right: push bar into pusher handles until spring buttons lock into place.

⚠ WARNING: Ensure both spring buttons are fully extended through the push bar before use.

⚠ WARNING: DO NOT use reclining wheelchair without both headrest and push bar installed.

4. To adjust the back angle, grasp both pusher handles securely and pull up on both release levers simultaneously. Gently lower or raise the back to the desired height, and release the levers.

FOLDING THE WHEELCHAIR FOR TRANSPORTATION OR STORAGE

Removing the Headrest and Pushbar (Reclining Models Only)



1. Press both pushbar spring buttons and pull pushbar out away from receivers.

2. Remove headrest cover, shown at above left.
3. Remove headrest as shown at above right: slide headrest up and off headrest support assembly as shown.

Closing the Wheelchair (All Models)



1. Detach footrests or legrests from wheelchair.
2. Remove seat cushion, if applicable.
3. Grab the seat upholstery at center front and rear with both hands, pull sharply, and lift up as shown above.
4. If necessary, fold the excess seat upholstery over the arm.
5. To fold wheelchair completely, tip it sideways so wheel won't drag and press sides together.

4 HANDLING TIPS

The Gendron Regency 450 / 525 has been designed and engineered to perform as a stable and well balanced unit when used for its intended purpose. However, it is possible to tip the Regency 450 / 525 over if it is used improperly or if you move beyond the center of gravity. You may want to consider the use of a positioning belt, available from your distributor or www.grahamfield.com, to maintain proper weight distribution. We urge you to learn the characteristics of your wheelchair. It is most important to learn safe methods to perform the daily activities basic to your lifestyle. Consult your medical professionals for assistance in developing the skills and proper techniques to perform all activities safely.

BALANCE

Proper balance is the key to maintaining the stability of your wheelchair. Reaching, bending, and transferring to or from a wheelchair will change your weight distribution and center of gravity. When performing such activities, do so as instructed in the following paragraphs to avoid tipping the wheelchair.

TRANSFER

- ⚠ WARNING: Always ensure the wheelchair is on a stable, level surface before transfer.**
- ⚠ WARNING: Always engage wheel locks before transfer.**
- ⚠ WARNING: Do not step on the footplates; this could cause the wheelchair to tip. Fold them up, and either detach them, or swing them aside.**

⚠ WARNING: There is a critical moment when there is little or no seat platform beneath you. Take every precaution to reduce this unsupported distance before you attempt transfer.

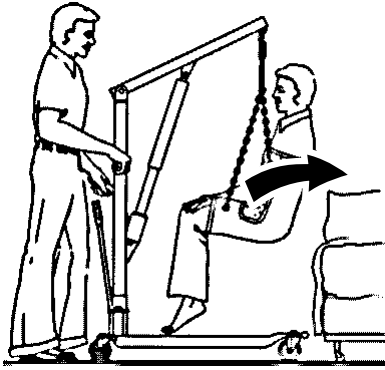

Patient Lift Transfer

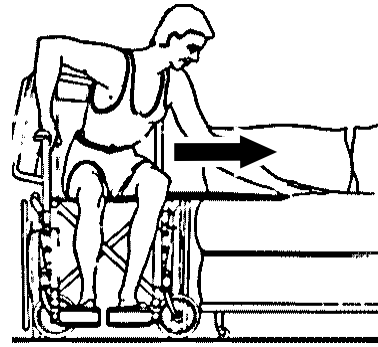

Transfer Board Transfer

Transferring into or out of a wheelchair is a very difficult maneuver; always exercise extreme care even when transferring with the aid of an attendant, a patient lift (shown at above left), or a transfer board (shown at above right). Consult your medical professionals for assistance in developing your individual transfer technique. Engage both wheel locks and ensure the wheelchair is stabilized and will not move or slide during the transfer. Take extra precautions to prevent tipping. Use good body mechanics to prevent personal injury.

REACHING / BENDING

⚠ WARNING: Always turn the casters frontward to provide stability while reaching. If in doubt, ask for assistance or use a device that will extend your reach without requiring you to shift your weight.

Although it is not recommended, you may find it occasionally necessary to lean or reach from your wheelchair. Consult with your healthcare professional for assistance in developing your personal safe reaching or moving techniques suited to your ability and restrictions.

REACHING / BENDING FORWARD OR SIDEWARD

⚠ WARNING: Do not attempt to reach objects if you are required to move forward in the seat. Do not attempt to retrieve objects from the floor if you must reach down between your knees. Do not shift your weight in the direction that you are reaching and/or bending; this could cause the wheelchair to tip.

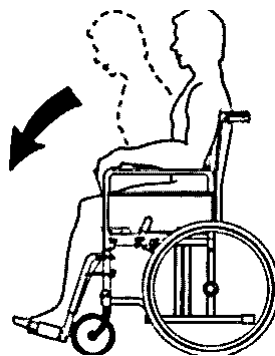

Reach Forward

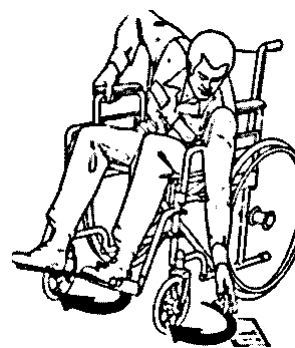

Reach Sideward

1. Maneuver the wheelchair as close as possible to the object you wish to reach.
2. Rotate both casters fully forward: Go forward, and then back the wheelchair toward the object to swing the casters fully forward.

3. Engage both wheel locks.
4. Ensure the casters are rotated fully forward before reaching. If not, repeat step 2.

REACHING / BENDING BACKWARD

⚠ WARNING: Do not engage the wheel locks while reaching or bending backward. Should your weight suddenly shift accidentally, it is better to roll in that direction than to tip over.

⚠ WARNING: Do not lean over the back upholstery; this could cause the wheelchair to tip.

1. Maneuver the wheelchair as close as possible to the object; the rear wheels will limit how close you can get.
2. Rotate both casters fully forward: Go forward, and then back the wheelchair toward the object to swing the casters fully forward.
3. Reach only as far as your arm will extend without changing your sitting position. If in doubt, reposition the wheelchair or ask for assistance.

RAMPS AND INCLINES

⚠ WARNING: During descent, the footplates' lowest point should be no closer to the ground than 2 1/2 inches to permit proper clearance.

⚠ WARNING: Do not attempt any incline or decline of more than 6 degrees (10% grade, or one foot of rise or fall per ten feet of ramp length).

⚠ WARNING: Do not use wheel locks to slow your descent. Attempting to use wheel locks is likely to result in accidental locking that could cause the wheelchair to stop abruptly, suddenly pitch forward, or tip sideways.

⚠ WARNING: Avoid changing direction while descending a ramp or incline, as this could cause instability.

Most people are capable of negotiating short inclines without assistance, depending upon upper body strength, endurance, and the degree of incline. Know your own strength and endurance capabilities and limitations before attempting to negotiate an incline or decline. Practice with an attendant or healthcare professional first before attempting any inclines, declines curbs or ramps. Always inspect the ramp for hazards such as holes, slippery or uneven surfaces, etc. before starting up or down. If you can not see the entire ramp, ask someone to inspect it for you.

ASCENT

Lean the upper part of your body slightly forward, as shown above, as you ascend the incline. If it becomes necessary to stop on the incline, avoid any abrupt or sudden forward movement as you resume climbing; this could cause tipping.

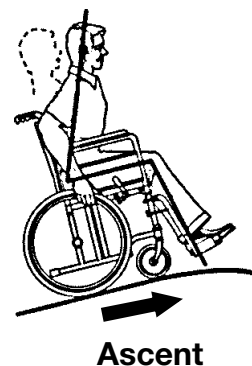

DESCENT

Always face forward when going down a ramp, but do not lean forward; this could cause tipping. Lean slightly backward to increase stability. It is critical to keep the wheelchair under control at all times. Descent should be made slowly and safely by grasping the handrims; however, use care, as friction heat will be generated. We recommend the use of gloves to reduce the effects of friction heat, but going slower is a better alternative.

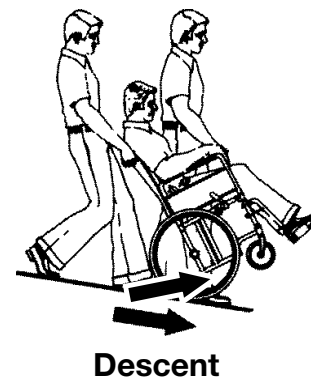

CURBS

Curbs should only be negotiated with the assistance of an attendant. When you encounter curbs, find a way around, or use the ramps now available in most locations. If there is no ramp available, avoid the curb by using the disabled-designated elevators now required in most locations.

CURBS – WITH ATTENDANT

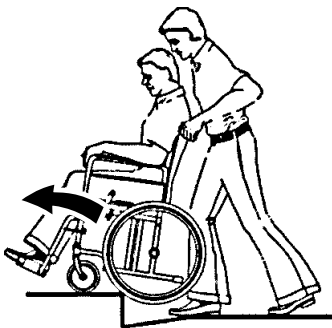

Going Up (Method 1)



Going Up (Method 2)

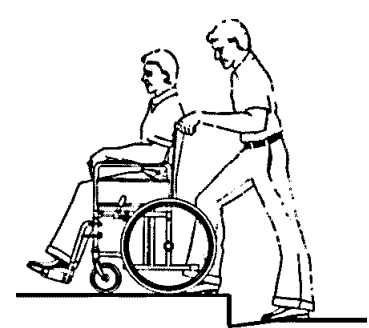

(Going Down)

⚠ WARNING: When approaching a curb, ensure the hand grips are securely fastened and do not turn or slip off.

Curbs should only be negotiated with the assistance of an attendant. The following are **suggestions only** for curb negotiation. It is important for you to develop your own safe technique that is best suited for your abilities with the aid of your healthcare professionals.

Going Up (Method 1)

When approaching a curb, ensure the hand grips are securely fastened and do not turn or slip off. Tilt the wheelchair backward to its balance point and move forward until the front casters pass over the top of the curb. Lower the front casters slowly onto the curb while lifting the wheelchair by the push handles, and push forward until the rear wheels roll up and over the curb. Ensure the wheelchair has completely cleared the curb and can not roll backwards.

Going Up (Method 2)

Ensure the hand grips are securely fastened and do not turn or slip off. Turn the wheelchair around and back up until the rear wheels are against the curb. Tilt the wheelchair back to its balance point and lift up by the push handles while pulling the wheelchair up and over the curb. **DO NOT** let the front casters down until the wheelchair is back far enough to clear the curb.

Going Down

Ensure the hand grips are securely fastened and do not turn or slip off. While standing behind the wheelchair, turn the wheelchair around and carefully back down the step. Hold the handgrips tightly and pull the wheelchair to where the rear wheels reach the curb edge, then slowly roll the rear wheels down onto the lower level. After the wheels are safely on the lower level, tilt the wheelchair back to its balance position and turn it face forward. Lower the front casters carefully by placing one foot on the tipping lever and gradually decreasing the force of exertion.

STAIRS AND ESCALATORS

⚠ WARNING: Never attempt to negotiate stairs or escalators in your Regency 450 / 525.

Stairs and escalators are dangerous obstacles. If you encounter steps and there is no ramp available, avoid the steps by utilizing the disabled designated elevators now required in most locations.

WEIGHT TRAINING

⚠ WARNING: This wheelchair is not designed or tested as a seat for weight training.

5 ADJUSTMENTS

The Regency 450 / 525 offers several adjustments to make it easier and more comfortable to drive. The **MAINTENANCE** section offers preventive maintenance suggestions for keeping your wheelchair in excellent condition; ensure that all components are in excellent condition before adjusting. The following are recommended methods; after a few adjustments, you may develop your own. Always consult your Graham-Field authorized distributor for assistance.

The person performing adjustments on the Regency 450 / 525 has the responsibility of making certain that the user can safely operate the wheelchair with the adjustments selected. This person must evaluate the user's ability, weight, physical condition, the environment in which the wheelchair will be used, and the terrain over which the wheelchair will travel.

All adjustments and their page locations are referenced in the index at the end of this manual. Specific tools needed to perform each adjustment are identified in adjustment directions. A complete list of tools needed to perform all adjustments in this section follows:

7/16" wrench, 1/2" wrench, Phillips head screwdriver (tools not included)

REAR WHEELS & CASTERS

We recommend that you do not replace or adjust rear wheel or caster components yourself, since special tools and training are required. Please contact your Graham-Field authorized distributor when your rear wheels or casters need adjustment.

ARMS



Removable Full-Length Arm



Removable Desk-Length Arm

Arm height and position are factory set; do not modify this. All arms are removable.

REMOVE ARM

Grasp the armpad by middle, depress the spring button at the front arm socket, and pull up on the arm to remove it from the socket.

INSTALL ARM

Grasp the armpad by middle, depress the spring button at the front arm socket, and push down on the arm to install it in the socket.

⚠ WARNING: Ensure both arms are securely locked into sockets before occupying or operating wheelchair.

SWINGAWAY FOOTREST / ELEVATING LEGREST



Swingaway Footrest



Elevating Legrest

- ⚠ WARNING: Avoid potential pinch points while swinging the Footrest or Elevating Legrest in or out.**
- ⚠ WARNING: The footplates' lowest point should be no closer to the ground than 2 1/2 inches, to permit proper clearance.**
- ⚠ WARNING: Do not stand on the footplates; this could cause the wheelchair to tip.**

SWING FOOTREST / LEGREST AWAY FOR TRANSFER

1. Push swingaway release lever, at top of Footrest / Legrest, rearward; Footrest / Legrest will swing outward.
2. Fold footplate upward and out of the way.
3. If wheelchair has Elevating Legrest, rotate calf pads upward 90° for transfer ease.

RETURN FOOTREST / LEGREST TO OPERATION POSITION

1. Rotate footplate downward, parallel with floor.
2. Swing Footrest / Legrest inward and lock it in place.
3. If wheelchair has Elevating Legrest, rotate calf pads downward 90° to occupy wheelchair.

⚠ WARNING: Ensure Footrest / Legrest extensions are locked in place, with footplates rotated downward, before occupying or operating wheelchair.

SWINGAWAY FOOTREST, ELEVATING LEGREST: ADJUST FOOTPLATE EXTENSION LENGTH

Tools required: 7/16" wrench

1. Use 7/16" wrench to remove through-bolt that holds footplate extension in position in Footrest / Legrest hanger.
2. Reposition footplate extension in desired position inside hanger.
3. Reinstall through-bolt in appropriate adjustment hole for desired footplate extension length. Use 7/16" wrench to tighten through-bolt.
4. Follow steps 1-3 to adjust other side's footplate extension length. Ensure both through-bolts are securely tightened and minimum ground clearance is 2 1/2 inches.

⚠ WARNING: Ensure footplate extensions are securely installed inside footrest or legrest before occupying or operating wheelchair.

ELEVATING LEGREST: RAISE LEGREST

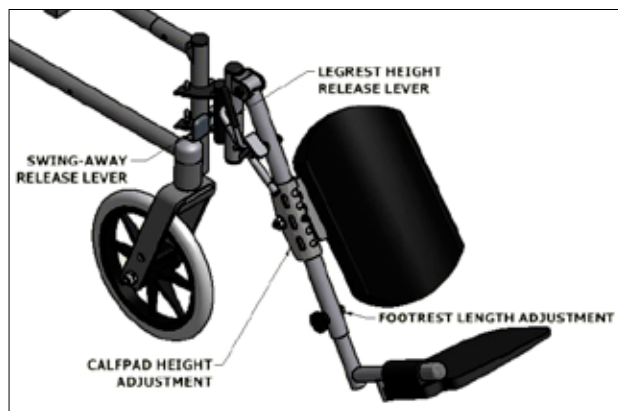

⚠ WARNING: Avoid potential pinch points while adjusting Elevating Legrest angle.

To raise the Elevating Legrest (adjust the legrest rotation angle):

1. Grasp the legrest near the footplate while holding the Legrest Height release lever (shown above).
2. Rotate the footplate up or down to the desired height.
3. Release the lever.

⚠ WARNING: Ensure Legrest is locked in place before occupying or operating wheelchair.

ELEVATING LEGREST: ADJUST CALF PAD POSITION

Calf pad position can be adjusted to five different points for ideal comfort:

1. Rotate the calf pad upward 45°; the calf pad will then be free to move between positions.
2. Slide calf pad to the preferred slot in the Calf Pad Height Adjustment Bracket (shown above).
3. Rotate calf pad back down to lock the positioning lug into the slot. In addition, calf pads can be rotated upwards 90° for ease of entering and exiting the chair.

⚠ WARNING: Ensure Legrest calf pads are locked in place before occupying or operating wheelchair.

ADDITIONAL CALF PAD ADJUSTMENTS

Tools required: Phillips head screwdriver (tool not included)

The calf pad is mounted at the factory in the most common position. Some cases require that more height adjustment is required than provided with swivel bracket (6).

The following illustration shows the means to raise or lower the calf pad an additional 2-9/16".

1. Remove two screws (1) and washers (2) from swivel plate (3) and calf pad (4).
2. Rotate calf pad 180 degrees.
3. Reinstall washers and screws thru swivel plate into calf pad.

Some cases also require more or less calf pad set-back to match the seat depth. The following illustration shows the means to adjust the calf pad forward or rearward by 1-1/4".

1. Remove two screws and washers from swivel plate and calf pad.
2. Remove nut (5).
3. Pull plate away from swivel bracket (6) far enough to turn plate 180 degrees.
4. Reinstall nut.
5. Reinstall washers and screws through plate into calf pad.

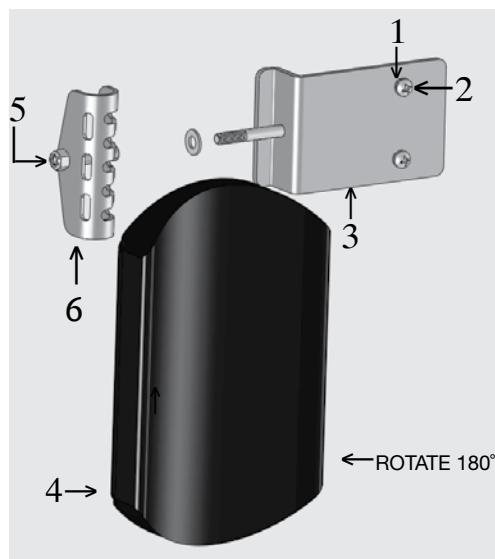

CROSSBRACES

TIGHTEN CROSSBRACES

Tools required: 1/2" wrench

Check the crossbraces to ensure that the bolt and nut securing both crossbraces in the center of the wheelchair are secure (crossbraces should be loose enough to fold easily, yet snug enough to take up excess play). Use a 1/2" wrench to tighten or loosen.

RECLINER (525 RECLINING MODEL ONLY)

ADJUSTING THE BACK ANGLE (525 RECLINING MODEL ONLY)

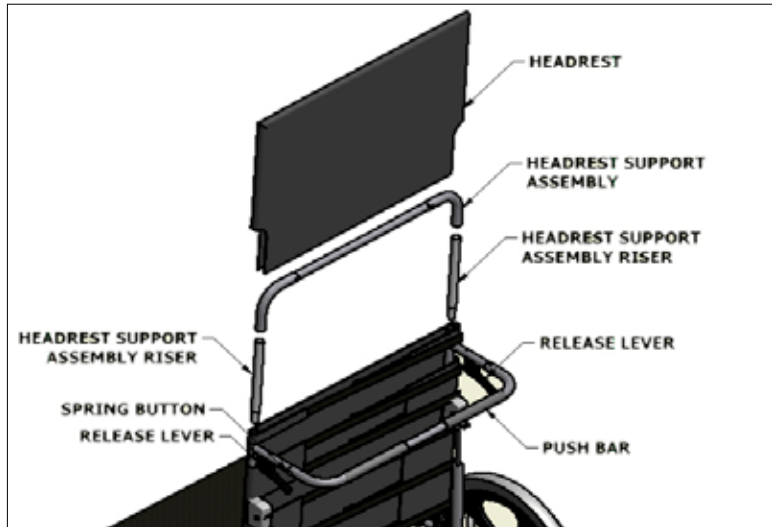

1. See picture above: to adjust the back angle, grasp both ends of push bar securely and simultaneously pull up on both release levers (use your hands to squeeze the end of push handles and release levers together).
2. Gently lower or raise the back to the desired height.
3. Release the levers.
4. When folding the wheelchair, disconnect the push bar from the right pusher handle, then depress the spring button on the left pusher handle and rotate the push bar downward 90°. The spring button should extend through the storage hole on the push bar.

WHEEL LOCKS

ADJUST WHEEL LOCKS

Tools required: 7/16" wrench

As a result of tire wear, wheel locks may need adjustment to prevent the rear wheels from turning when the wheel locks are engaged.

To adjust wheel locks:

1. Use a 7/16" wrench to loosen the two locknuts (shown at right) until the lock slides on the frame.
2. Place the wheel lock in the locked position and slide it into contact with the tire.
3. Place the wheel lock in the unlocked position and slide it 3/8" closer to the tire.
4. Use a 7/16" wrench to tighten the two clamp bolts and engage the lock to check the fit. The lock should indent the tire at least 3/8". Tighten clamp bolts securely to eliminate wheel lock movement on frame.

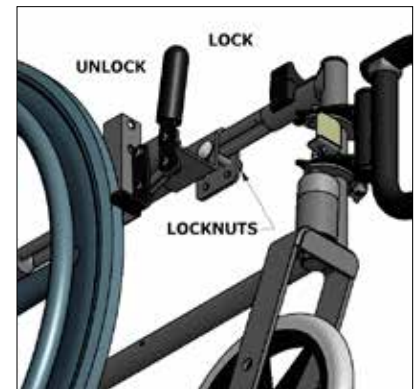

Wheel Lock

⚠ WARNING: Ensure wheel locks are adjusted so that they lock in place appropriately before occupying or operating wheelchair.

6 TRANSPORTING THE GENDRON REGENCY 450 / 525

⚠ WARNING: This wheelchair does not offer seating or occupant restraint equivalent to the seat provided in a motor vehicle! To increase your safety while traveling in a motor vehicle, always transfer to the vehicle seat and use the restraint provided by the vehicle manufacturer.

Follow the instructions in **FOLDING THE WHEELCHAIR FOR TRANSPORTATION OR STORAGE**, page 9.

TRANSPORTING THE WHEELCHAIR

When transporting the wheelchair in a motor vehicle, do not place the wheelchair where it will interfere with the safe operation of the vehicle or endanger the driver or passengers. The front seat IS NOT a good location to store a wheelchair during transport — it can be dislodged and become a serious hazard to the driver. Always take precautions to avoid personal injury when loading or lifting a wheelchair into or out of a vehicle.

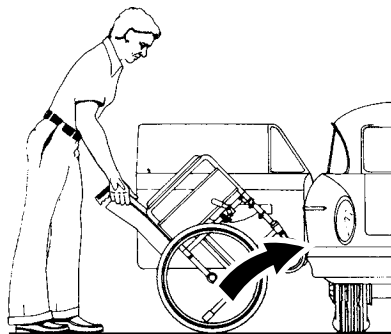

Lifting Wheelchair into Rear Seat or Trunk

Rear Seat: Move the front seat as far forward as possible. Fold the wheelchair as described on previous page and face it toward the open car door. Tilt the wheelchair backwards as shown above and roll it forward on the rear wheels. Push the wheelchair forward so the casters enter the car. Tilt the wheelchair away from the back of the front seat, then lower the casters to the floorboard. Slowly lift-roll the chair into the car.

⚠ WARNING: Ensure the wheelchair is stable and will not shift while the car is in motion.

⚠ WARNING: Ensure the wheelchair does not block the driver's field of vision.

Trunk: Fold the wheelchair as described on previous page and set the wheel locks. Grasp the front of the frame and rear of the wheels and lift the wheelchair carefully, using good body mechanics to avoid injury, and place it in the trunk.

⚠ WARNING: DO NOT put any articles on top of the wheelchair.

Close the trunk lid slowly.

Follow the instructions in **UNFOLDING AND FOLDING THE WHEELCHAIR**, pages 7 and 8, to reassemble the wheelchair.

7 MAINTENANCE

Protect your Gendron Regency 450 / 525 by having it serviced regularly. Proper care and maintenance are essential to keep your wheelchair in safe working condition. Periodic inspection, adjustment, and replacement of worn parts will provide many years of superb performance. When you believe that a component or part of your Regency 450 / 525 is not functioning properly, contact your Graham-Field authorized distributor immediately, as a potentially hazardous condition could result. Only excellent condition is acceptable where safety is concerned.

SERVICE MANUAL

There is no service manual for the Regency 450 / 525. Please contact your Graham-Field authorized distributor with service questions not answered by this manual.

Info: We recommend that you have a Graham-Field authorized distributor perform a six month maintenance check, as the distributor may find and correct a problem which might otherwise go undetected and eventually cause more serious problems and/or personal injury.

DO-IT-YOURSELF MAINTENANCE

You can do many of the scheduled maintenance tasks yourself, if you have mechanical ability and a few basic tools. Refer to the maintenance schedule on the next page for the recommended regularity of each procedure. If any maintenance procedure is not clear to you, ask your Graham-Field authorized distributor for assistance.

▲ NOTICE: Improper maintenance can cause operating problem and may affect your warranty.

⚠ WARNING: Unauthorized modification or the use of non-Gendron replacement parts could change the structure of the wheelchair, void the warranty, and create a hazardous condition resulting in serious personal injury.

MAINTENANCE SCHEDULE				
Procedure	Perform at least every			
	Week	Month	3 Months	6 Months
Check tire wear	✓			
Check handrims	✓			
Check wheel lock engagement	✓			
Check anti-tippers	✓			
Wipe off frame with soft cloth	✓			
Check Crossbraces	✓			
Check handgrips		✓		
Check upholstery		✓		
Check rear wheel adjustment		✓		
Check arms		✓		
Check backposts / push handles		✓		
Check footrests / elevating legrests		✓		
Clean frame			✓	
Check caster stem rotation (distributor)			✓	
GF distributor maintenance check				✓
Check rear wheel bearings (distributor)				✓
Check caster bearings (distributor)				✓

LIST OF TOOLS *(tools not included)*

30 weight oil (available at most auto parts stores)

Phillips screwdriver

Soft cloth

Mild soap and water solution

The tools and cleaning supplies listed will assist in the following procedures:

GENERAL CARE

Always evaluate the overall operation of your wheelchair. It should function with ease and should travel straight without excessive drag or pull to one side.

Remember, your Graham-Field authorized distributor knows your wheelchair best when it comes to service and repairs. Contact your authorized distributor with any questions or concerns regarding the safe operation and maintenance of your wheelchair. Regular maintenance is essential for your safety and continued operation of your wheelchair.

CHECK TIRE WEAR

Examine tires at least once a week for surface wear and cracks and replace them as needed. Replace solid rubber tires when they become loose on the rims or cracks appear.

CHECK HANDRIMS

Check handrims at least once a week. Inspect each handrim for rough or sharp edges and, if any are found, replace handrims immediately. Ensure that all hardware is properly aligned and secure.

CHECK WHEEL LOCK ENGAGEMENT

Check wheel lock engagement at least once a week. See **Adjust wheel locks** in the **ADJUSTMENTS** section to adjust wheel lock engagement. If a wheel lock is worn or damaged, replace it immediately. Inspect the hardware for looseness or signs of wear.

Ensure the locking mechanism operates smoothly. The locking assembly should be tight enough so that the wheel can not rotate or the lock slip. Check that the locking shoe does not press against the tire when in the unlocked position. Excessive force should not be required to either engage or release wheel locks. Oil the wheel lock pivot points with one or two drops of 30 weight oil. Remove excess oil and dirt.

CHECK ANTI-TIPPERS (STANDARD ONLY ON RECLINING MODELS)

Check the anti-tippers at least once a week. Ensure anti-tippers are securely fastened and properly positioned.

CHECK HANDGRIPS

Check handgrips at least once a week. Ensure they are not ripped; ensure they are tight and securely fastened.

CHECK CROSSBRACES

The locknut on the pivot bolt should be snug, but not overly tight. If the pivot bolt becomes worn, replace both it and the locknut.

CHECK UPHOLSTERY

Check upholstery at least once a month. Inspect for rips, tears and worn spots. Ensure that all upholstery-attaching screws are present, properly aligned, and well-secured. Use a Phillips screwdriver to tighten upholstery mounting screws. Check attaching screws for sharp edges or stripped screws, and replace if found.

⚠ WARNING: Worn or torn upholstery, or upholstery with loose hardware, must be replaced immediately. It may not support body weight.

CHECK REAR WHEEL ADJUSTMENT

Inspect the wheels at least once a month. Check alignment by elevating the rear of the wheelchair on a stable object until the rear wheels clear the ground, or placing the wheelchair upside down in a stable position such that the wheels can spin freely. Spin the wheels; there should be no wobble or sideplay, and the wheels should spin freely without binding. The bearings should be clean and rotate smoothly. Check rim sideplay to verify that bearings are not too loose. If there is a problem, contact your Graham-Field authorized distributor. If adjustment is required, this should be done by your Graham-Field authorized distributor only.

CHECK ARMS

Check arms at least once a month. Inspect for sharp edges or cracks which could weaken the arm, and replace if found. Ensure all attaching screws are present and tight. Use a Phillips screwdriver to tighten armpad mounting screws. Check for burrs on the screw heads and replace if found. Ensure that screws do not extend into the padding. Confirm that the posts at base of arm fit correctly in the sockets, snug but not binding.

CHECK BACKPOSTS / PUSH HANDLES

Check backposts at least once a month. Ensure that all mounting hardware is securely fastened and that the backposts are not bent or damaged. Contact your authorized distributor if you observe cracking or peeling paint or plating.

CHECK FOOTRESTS & ELEVATING LEGRESTS

Check footrests and legrests at least once a month. Inspect the locking mechanisms to confirm sure fit. Check for cracks, burrs, or sharp edges, and replace if found. Ensure that the footrest or legrest will automatically lock securely in place and will not accidentally unlock.

CLEANING YOUR REGENCY 450 / 525

Wipe off base and seat frame frequently, at least once a week, using a soft cloth. Dry the wheelchair immediately if exposed to moisture. Clean the frame every three months with a mild soap and water solution. The frame does not need to be waxed. Do not use solvents, abrasive waxes, caustic chemicals, or spray silicone. Never use abrasive cleansers; they could scratch the finish. Never use steam or high pressure cleaners. Clean upholstery and plastic components at least once a month with a mild soap and water solution.

CHECK CASTERS

Check the caster stems for proper rotation at least every three months. The caster forks must swivel freely to facilitate steering and handling. Adjusting the stem nut varies the amount of force required to turn the caster. If the nut is too loose, the caster will flutter or shimmy; if too tight, the wheelchair will be difficult to steer. If the caster stems require adjustment, or the stem bearings require replacement, contact your Graham-Field authorized distributor. Ensure that stems are firmly attached to forks, and that forks and stems are not bent. Evaluate all threads, locking nuts and bearings.

CHECK WHEEL BEARINGS

Have your Graham-Field authorized distributor check caster and rear wheel axle bearings at least every six months.

8 TROUBLESHOOTING

Continual use of your Regency 450 / 525 necessitates maintenance, especially if the factory-set adjustments have been altered. The following troubleshooting guide lists several common problems that may occur, and offers corrective actions for each. If you are unsure of the solution or unable to diagnose the problem, do not hesitate to ask your Graham-Field authorized distributor for assistance.

SYMPTOM						PROBABLE CAUSE AND CORRECTIVE ACTION
looseness in wheelchair	squeaks / rattles	caster flutter	sluggish turning	chair veers left	chair veers right	
✓	✓	✓	✓			Nuts and / or bolts may be loose. If so, tighten. Bolts should be snug.
		✓	✓	✓	✓	Rear wheels and / or casters may be adjusted improperly. Ensure that both rear wheels are mounted in identical positions, and that casters are mounted in identical positions.
		✓	✓	✓	✓	Caster stem(s) may be adjusted improperly. See distributor to correct adjustment.

Info: Use only Gendron replacement parts. A Regency 450 / 525 parts catalog is available at www.grahamfield.com to assist in the ordering of parts.

- ⚠ CAUTION: A complete inspection of your wheelchair, including maintenance, servicing and safety checks, should be performed by a Graham-Field authorized distributor at least every six months.**
- ⚠ WARNING: Unauthorized modification or the use of non-Gendron replacement parts could change the structure of the wheelchair, void the warranty, and create a hazardous condition, which could result in serious personal injury.**

9 SPECIFICATIONS

Specification	Model			
	450 Standard	450 Recliner	525 Standard	525 Recliner
Overall Depth	43.5" (110.5 cm)	52.5" (133.4 cm)	43.5" (110.5 cm)	52.5" (133.4 cm)
Overall Height	37" (94.0 cm)	52.5" (133.4 cm)	37" (94.0 cm)	52.5" (133.4 cm)
Overall Width	33", 35", 37", or 39" (83.8 cm, 88.9 cm, 94.0 cm, or 99.1 cm)		34", 36", 38", or 40" 86.4 cm, 91.4 cm, 96.5 cm, 101.6 cm)	
Width Folded	17" (43.2 cm)		19" (48.3 cm)	
Back Height	18.5" (47.0 cm)	36" (91.4 cm)	18.5" (47.0 cm)	36" (91.4 cm)
Seat Depth	20" (50.8 cm)			
Seat Height	17.5" (44.5 cm)		15.5" or 17.5" (39.4 cm or 44.5 cm)	
Seat Width	24", 26", 28", or 30" (61.0 cm, 66.0 cm, 71.1 cm, or 76.2 cm)			
Weight Without Front Rigging	63 lb (28.6 kg)	94 lb (42.6 kg)	63 lb (28.6 kg)	94 lb (42.6 kg)
Maximum Weight Capacity, EVENLY DISTRIBUTED	450 lb (204.1 kg)		525 lb (238.1 kg)	

10 LIMITED WARRANTY

SCOPE OF WARRANTY

GF Health Products, Inc. (GF) warrants to the original purchaser only that it will replace or repair components, at GF's sole discretion, that are defective in material or workmanship under normal use and service. All warranties are conditioned upon the proper use of the products strictly in accordance with good commercial practice and applicable GF instructions and manuals, including proper use and maintenance. To the extent that a component is warranted by a third party, GF conveys all of its rights under that warranty to the original purchaser, to the extent permitted.

This limited warranty shall only apply to defects that are reported to GF's customer service team within the applicable warranty period and which, upon examination by GF or its authorized representative, prove to be a warranty item. This limited warranty is not transferable.

The warranted components and time period are set forth below:

- Sideframes and crossbraces: five (5) years
- Wheels, handrims, front rigging, forks:..... one (1) year
- All other durable components not listed above: six (6) months

The applicable warranty period shall commence from date of shipment to the original customer, unless there is an expiration date on the component in which case the warranty shall expire on the earlier of warranty period or the expiration date.

OBTAINING WARRANTY SERVICE

This limited warranty shall only apply to defects that are reported to the Distributor from whom the Customer purchased the product within the applicable warranty period. If there is not a Distributor, you must contact GF directly by calling 1.770.368.4700, sending a fax request to 1.770.368.2386, or by e-mailing a request to cs@grahamfield.com. Specific directions will be provided by the Customer Service Representative. Failure to abide by the specific directions will result in denial of the warranty claim.

EXCLUSIONS

The warranty does not cover and GF shall not be liable for the following:

- 1) Defects, damage, or other conditions caused, in whole or in part, by misuse, abuse, negligence, alteration, accident, freight damage, tampering or failure to seek and obtain repair or replacement in a timely manner;
- 2) Products which are not installed, used, or properly cleaned and maintained as required in the official manual for the applicable product;
- 3) Products considered to be of a non-durable nature including, but not limited to: filters, fuses, gaskets, lubricants, and charts;
- 4) Accessories or parts not provided by GF;
- 5) Charges by anyone for adjustments, repairs, replacement parts, installation or other work performed upon or in connection with such products which are not expressly authorized in writing, in advance, by GF;
- 6) Any labor or shipping charges incurred in the replacement part installation or repair;
- 7) Costs and expenses of regular maintenance and cleaning; and
- 8) Representations and warranties made by any person or entity other than GF.

ENTIRE WARRANTY, EXCLUSIVE REMEDY AND CONSEQUENTIAL DAMAGES DISCLAIMER

THIS WARRANTY IS GF'S ONLY WARRANTY AND IS IN LIEU OF ALL OTHER WARRANTIES, EXPRESS OR IMPLIED. GF MAKES NO IMPLIED WARRANTIES OF ANY KIND INCLUDING ANY IMPLIED WARRANTIES OF MERCHANTABILITY OR FITNESS FOR A PARTICULAR PURPOSE.

IF ANY MODEL OR SAMPLE WAS SHOWN TO THE CUSTOMER, SUCH MODEL OR SAMPLE WAS USED MERELY TO ILLUSTRATE THE GENERAL TYPE AND QUALITY OF THE PRODUCT AND NOT TO REPRESENT THAT THE PRODUCT WOULD NECESSARILY CONFORM TO THE MODEL OR SAMPLE IN ALL RESPECTS.

THIS WARRANTY IS LIMITED TO THE REPAIR OR REPLACEMENT OF THE DEFECTIVE PARTS. GF SHALL NOT BE LIABLE FOR AND HEREBY DISCLAIMS ANY DIRECT, SPECIAL, INDIRECT, INCIDENTAL, EXEMPLARY OR CONSEQUENTIAL DAMAGES, INCLUDING, BUT NOT LIMITED TO: DAMAGES FOR LOSS OF PROFITS OR INCOME, LOSS OF USE, DOWNTIME, COVER, OR EMPLOYEE OR INDEPENDENT CONTRACTOR WAGES, PAYMENTS AND BENEFITS.

The warranties contained herein contain all the representations and warranties with respect to the subject matter of this document, and supersede all prior negotiations, agreements and understandings with respect thereto. The recipient of this document hereby acknowledges and represents that it has not relied on any representation, assertion, guarantee, warranty, collateral contract or other assurance, except those set out in this document.

For additional information on this product or this warranty, please contact a GF Customer Service Representative.

NOTES:

- 1) Additional terms and conditions may apply.
- 2) Freight claims must be notated on the appropriate shipping documents and must be made with immediacy. International, federal and state regulations govern specific requirements for freight claims. Failure to abide by those regulations may result in a denial of the freight claim. GF will assist you in filing the freight claim.
- 3) Claims for any short shipment must be made within three (3) days of the invoice date.

11 INDEX

A

Adjusting back angle 17
Adjustments 13
Anti-tippers, check 20
Arm, install 14
Arm, remove 14
Arms 14
Arms, check 21

B

Backposts, check 21
Balance 9

C

Calf Pad Adjustments 16
Casters 13
Caster stems, check 22
Cleaning your Regency 450 / 525 21
Closing the wheelchair (all models) 9
Crossbraces, check 20
Crossbraces, tighten 16
Curbs and steps 12

F

Folding the wheelchair for transportation or storage 8
Footrest, check 21
Footrest, for transfer 15
Footrest, return 15

G

General Care 20
Getting started 6

H

Handling tips 9
Handrims, check 20

I

Info statement, significance 3
Installing the headrest and pushbar (reclining models only) 8
Introduction 3

L

Legrest, raise 15
Legrest, for transfer 15
Legrest, to operation position 15

Limited warranty 25

M

Maintenance 19

N

NOTICE statement, significance 3

O

Opening the wheelchair (all models) 7

R

Ramps and Inclines 11
Reaching / bending 10
Rear wheel adjustment, check 21
Rear wheels 13
Regency 450, illustration 6
Removing the headrest and pushbar (reclining models only) 9

S

Safety precautions 4
Setup 6
Specifications 24
Swingaway Footrest, Elevating Legrest 14
Swingaway Footrest, Elevating Legrest, adjust extension length 15

T

Tires, check 20
Tools, for adjustment, list 14
Tools, for maintenance, list 20
Transfer activities 9
Transporting the Regency 450 / 525 18
Troubleshooting 23

U

Unfolding the wheelchair 7
Upholstery, check 21

W

Warnings 4
WARNING statement, significance 3
Warranty, limited 25
Weight training 13
Wheel bearings, check 22
Wheel lock engagement, check 20
Wheel locks, adjust 17
Wheel locks, operating 6

GENDRON[™]

by graham-field



+1 770.368.4700

Information contained herein is subject to change without notice.
The most current and complete product information can be found on our website.

www.gendroninc.com | www.grahamfield.com

© 2022, GF Health Products, Inc. All Rights Reserved.
Gendron is a trademark of GF Health Products, Inc.



Manufactured By:
GF Health Products, Inc.
One Graham-Field Way, Atlanta, GA 30340

GD_450-525-INS-LAB-RevB22