

# ZLINE

ATTAINABLE LUXURY<sup>®</sup>

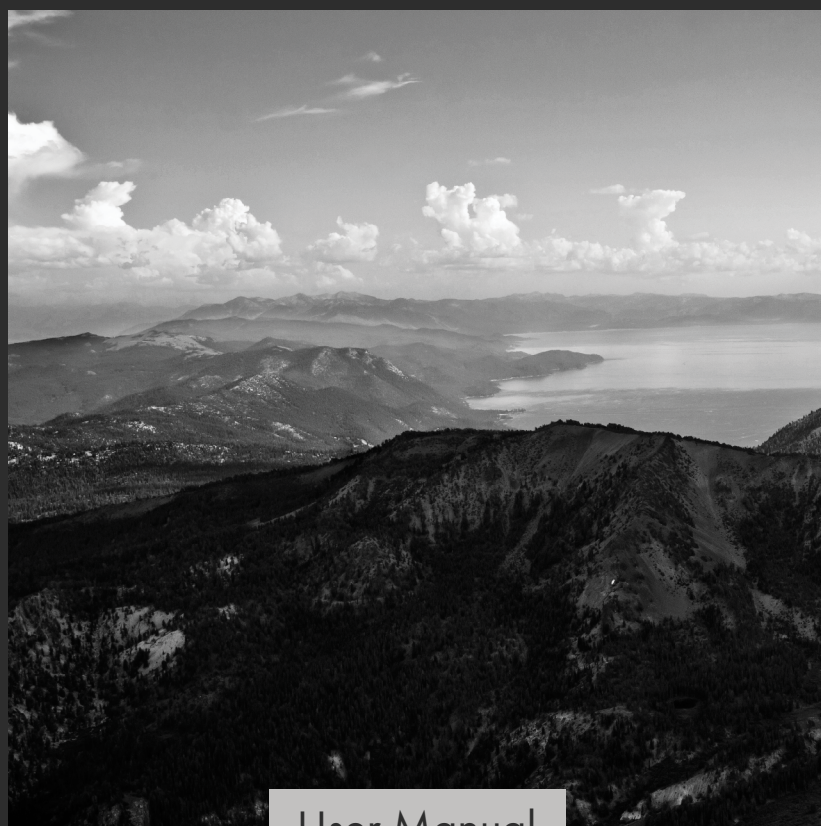

User Manual

## SINGLE WALL OVEN

[www.zlinekitchen.com](http://www.zlinekitchen.com)



ZLINE Kitchen and Bath provides Attainable Luxury, where the kitchen and bath of your dreams is never out of reach. Through our unique designs and unparalleled quality, we're dedicated to providing you an elevated experience in the heart of your home. With an endless selection of features and finishes, our inspiration is your reality.

**ZLINE**  
ATTAINABLE LUXURY®



ZLINE is fueled by a passion for innovation; A relentless pursuit of bringing the highest end luxury designs and professional features into everyone's homes. Because we continually strive to improve our products, we may change specifications and designs without prior notice.

**⚠ WARNING:** This product can expose you to chemicals including nickel, which is known to the State of California to cause cancer. For more information, go to [www.P65Warnings.ca.gov](http://www.P65Warnings.ca.gov).

# TABLE OF CONTENTS

IMPORTANT SAFETY INSTRUCTIONS	1
OPERATION	5
• Control Panel	
• Settings	
• Preheating	
• Temperature Control	
• Oven Modes	
• Convection Conversion	
• Cooking Tips	
MAINTENANCE AND CLEANING	35
TROUBLESHOOTING	43
WARRANTY	48

# SAFETY INSTRUCTIONS



## WARNING

If the information in this manual is not followed exactly, a fire or explosion may result causing property damage, personal injury, or death.

Before beginning installation, please read and follow these important instructions for the safety of your home and the people living in it. Always read and obey all safety measures. To reduce the risk of fire, electrical shock, injury to persons, or damage when using the oven, follow basic precautions, including the following:

## PROPER INSTALLATION

This appliance must be properly installed and electrically grounded by a qualified technician. Connect only to a properly grounded outlet. See the “Electrical Grounding Instructions” section in the Installation Manual for this product.

- This appliance should be serviced only by a qualified service technician. Contact the nearest authorized service center for examination, repair, or adjustment.
- Do not repair or replace any part of the oven unless specifically recommended by a professional. Refer service to an authorized servicer.
- Do not operate this appliance if it is not working properly or if it has been damaged until an authorized servicer has examined it.
- Install this appliance only in accordance with the installation instructions.
- Use this oven only as intended by the manufacturer. If you have any questions, contact ZLINE at 1-614-777-5004.
- Do not cover or block any openings on this appliance.
- Do not use corrosive chemicals, vapors, or nonfood products in this appliance. This type of oven is specifically designed to heat or cook. It is not designed for industrial or laboratory use. The use of corrosive chemicals in heating or cleaning will damage the appliance.
- The manufacturer will not be responsible for any damage to property or to persons caused by incorrect installation, improper use of the appliance, or failure to heed the warnings listed, and the warranty will be voided.

# SAFETY INSTRUCTIONS

- Do not overcook food. Carefully attend oven if paper, plastic or other combustible materials are placed inside the oven.
- Do not use the cavity for storage purposes. Do not leave paper products, cooking utensils or food in the cavity when not being used.

## TO REDUCE THE RISK OF FIRE INSIDE THE OVEN

- Do not store flammable materials in or near the oven.
- Do not use water on a grease fire. Smother fire or use a dry chemical or foam-type extinguisher.
- It is highly recommended that a fire extinguisher be readily available and highly visible next to any cooking appliance.
- Do not overcook food. Carefully oversee oven if paper, plastic, or other combustible materials are placed inside the oven.
- Do not use the oven for storage purposes. Do not leave paper products, cooking utensils, or food in the oven when not being used.
- If materials inside the oven should ignite, keep the door closed. Turn oven off and disconnect the circuit at the circuit breaker box.
- Be sure the cooling fan runs whenever the oven is in operation. If the fan does not operate, do not use the oven. Call an authorized service provider.
- NEVER use this appliance as a space heater to heat or warm the room. Doing so may result in carbon monoxide poisoning.

## PERSONAL SAFETY

- Do not allow children to use this appliance unless closely supervised by an adult. Children and pets should not be left alone or unattended in the area where the appliance is in use. Never allow children to sit or stand on any part of the oven.
- For personal safety, wear proper clothing. Loose-fitting clothes or garments with hanging sleeves should never be worn while using this appliance.
- Tie long hair so that it doesn't hang loose.
- Do not touch heating elements or interior surfaces of oven.
- The heating elements may be hot even though they are dark in color. Interior surfaces of an oven become hot enough to cause burns.

# SAFETY INSTRUCTIONS

- During and after use, do not touch or let clothing or other flammable materials contact the heating elements or the interior surfaces of the oven until they have had sufficient time to cool.
- Please note that the trim on the top and sides of the oven door may become hot enough to cause burns.
- Use care when opening the door. Open the door slightly to let hot air or steam escape before removing or replacing food.
- Do not heat unopened food containers. Build-up of pressure may cause the container to burst and cause injury.
- Always place oven racks in desired location while oven is cool. If a rack must be moved while oven is hot, do not let potholder contact the hot heating elements.
- Use only dry potholders or oven mitts. Moist or damp potholders on hot surfaces may result in burns from steam. Do not use a towel or other bulky cloth.

# SAFETY INSTRUCTIONS

## SELF CLEANING OVEN SAFETY

- Before self-cleaning the oven, remove the broiler pan, oven racks, other utensils, and excess soft spillage.
- Confirm that the door locks and will not open once the Self Clean option is selected and the door lock icon appears. If the door does not lock, turn the cook mode selector to OFF and do not run Self Clean. Call ZLINE at 1-614-777-5004 or an authorized service provider.
- Do not clean the door gasket. It is essential for a good seal. Care should be taken not to rub, damage, or remove the door gasket.
- Do not use commercial oven cleaners or oven liner protective coatings of any kind in or around any part of the oven.
- Clean only oven parts listed in this manual.
- Other surfaces of the appliance may become hot enough to cause burns, including oven vent openings and surfaces near these openings, oven doors, and windows of oven doors.
- Turn to the Maintenance and Cleaning section on page 36 for Self Clean mode operation and other cleaning advice.
- The manufacturer reserves the right to make changes to its products when considered necessary and useful, without affecting the essential safety and operating characteristics.
- **IMPORTANT:** The installer should leave these instructions with the consumer who should retain for local inspectors' use and for future reference.



# OPERATION

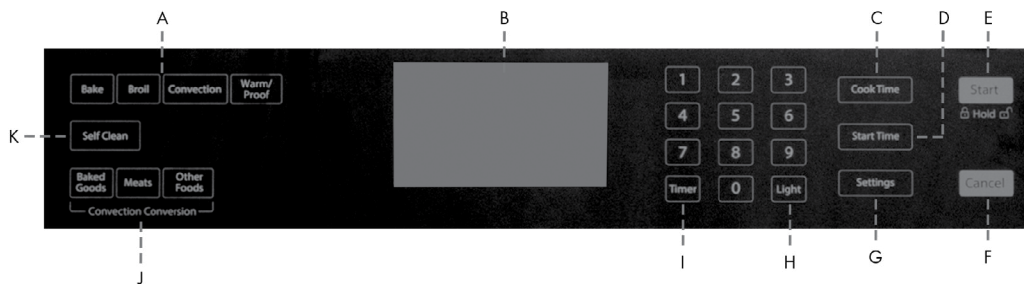

- A. Oven Mode Controls
- B. Display
- C. Cook Time
- D. Start Time
- E. Start/Control Lock (hold 3 seconds)
- F. Cancel
- G. Settings
- H. Light
- I. Timer
- J. Convection Conversion Mode Controls
- K. Self-Clean

## OVEN MODE CONTROLS: Bake, Broil, Convec, Warm/Proof

- Select from Bake, Broil, Convec, and Warm/Proof oven modes.

**NOTE:** The Warm/Proof control toggles between the two oven modes.

## DISPLAY

- When power is first supplied to the oven or if a power failure occurs, "12:00" will appear on the display.
- See "Clock" later in this section for instructions to set the time-of-day. When the oven is not in use, the time-of-day appears in the display.

## START

- The Start control begins any oven function. If Start is not pressed within 2 minutes after pressing the keypad, the function is canceled and the time-of-day is displayed.



## CONTROL PANEL LOCKOUT

The control panel can be locked to avoid unintended use of the oven.

- The control cannot be locked if the oven is in use or if Cook Time is operating.
- The current time-of-day will remain in the display when the control is locked.

# OPERATION

## TO LOCK/UNLOCK CONTROL PANEL

- Press and hold Start for 3 seconds or until  symbol appears in the display.  symbol will remain lit in the display. Press and hold Start for 3 seconds or until  symbol disappears.

## CANCEL

- Press the Cancel button to stop any function except Cook Time and Control Panel Lockout.

## LIGHT

- The oven lights turn on and off automatically when the door is opened and closed. Press the Light button to turn the lights on/off when the door is closed.

## TIMER

- The Timer can be set in hours or minutes up to 12 hours.
- Example: Pressing "1" will set the Timer for 1 minute. Pressing "10" will set the Timer for 10 minutes. Pressing "100" will set the Timer for 1 hour. Pressing "1000" will set the Timer for 10 hours.
- **NOTE:** The Timer cannot be set in quarter- or half-minute increments.

## TO SET THE TIMER

1. Press TIMER.
2. Use the number keypad to enter the length of time in hours and minutes.
3. Press TIMER to begin the countdown. If enabled, timer tone(s) will sound at the end of countdown.
4. Press TIMER to cancel the Timer and return to the time-of-day.
  - Do not press Cancel because the oven will turn off.

# OPERATION

## COOK TIME

- The Cook Time feature allows the oven to be set to cook for a set length of time and then turn off automatically.
- You must select an Oven Mode before you can set a Cook Time.
- Cook Time can be set in hours or minutes up to 12 hours, same as the Timer.
- At the end of Cook Time, the oven will turn off automatically, the alert tone will sound, and "Cooking Complete" will appear in the text area.
- Cook Time must be off before pressing other buttons. Pressing other buttons will not interrupt the Cook Time.

## TO SET COOK TIME

1. Select Oven Mode (Bake, Broil, Convection, etc.).
2. Select temperature.
3. Press Cook Time. Enter the desired cook time by pressing the number keypad.
4. Press Start. The oven will begin to preheat.
  - During preheating, "Low" will be displayed for 2-4 minutes until the oven reaches the minimum temperature of 170°F, after which the temperature display will rise. It will take anywhere from 5 to 15 minutes for the desired cooking temperature to be reached. A sound will chime 3 times once done preheating.
  - Cook Time format is **h:m** (hours:minutes), switching to **m:s** (minutes:seconds) during the last minute.
  - When setting a Cook Time while the oven is preheating, the pre-selected end temperature will display in the bottom right corner. After the Cook Time is set, the countdown will be featured on the main display, while "Preheating" will display at the bottom.

# OPERATION

## START TIME

- This feature allows you to set the oven to turn on at a later time.
  - The clock must be set to the correct time-of-day.
1. Select an Oven Mode.
  2. Select temperature.
  3. Set Cook Time.
  4. Press Start Time.
  5. Enter the Start Time via the number keypad. "Press Start" will appear the display. If Cook Time was not set, the control will prompt you to "Set Cook Time."



Do not let food sit in the oven more than one hour before or after cooking. Doing so can result in food poisoning or sickness.

6. Place the food in the oven and close the oven door.
7. Press Start. Start Time will begin counting down until it reaches the set time-of-day.
  - NOTE: At the end of Cook Time, the oven will turn off automatically, an alert tone will sound, and "Cooking Complete" will appear in the display.

## SETTINGS

- The Settings control allows you to access the menu for additional functions and features.
1. Clock
  2. Temp Unit
  3. Sound
  4. 12/24 Hour
  5. Language
  6. Sabbath
  7. Brightness
  8. Calibration
  9. Demo Mode
- Press Settings to show Menu Options 1-6. Press Start to show Options 7-9.

# OPERATION

## CLOCK

The clock can be set to display time in a 12-hour or 24-hour format. The clock is factory preset for the 12-hour format.

### TO SET THE CLOCK

- Before setting the clock, make sure both the Oven and Timer are turned off.
- 1. Press Settings. The various Options will appear in the display.
- 2. Press 1 on the number keypad. "Clock" will appear in the display.
- 3. Press the number keypad to enter the time-of-day.
- 4. Press Start to toggle between am and pm.
- 5. Press Settings to confirm; time-of-day is set.

### TO CHANGE THE CLOCK TO 24-HOUR FORMAT

1. Press SETTINGS. The various Options will appear in the display.
2. Press "5" on the number keypad. "12/24 HOUR" and "12" will appear in the display.
3. Press "1" on the number keypad to change the 12/24 Hour setting to 24-hour.
4. Press SETTINGS to confirm. The 12/24-Hour setting has been changed.

## TONES

- Tones are audible signals, indicating the following:
- Number of tones: 1
  - Valid press
  - Function has been entered
  - Oven is preheated
- Number of tones: 2
  - Invalid touch pad press
- Number of tones: 3
  - End of cycle
- Number of tones: 4
  - End of TIMER

# OPERATION

## TO TURN ON/OFF SOUND

- The oven sound is factory preset for On but can be changed to Off.
1. Press **SETTINGS**. The various Options will appear in the display.
  2. Press "3" on the number keypad. "SOUND" and "ON" will appear in the display.
  3. Press "1" on the number keypad. "ON/OFF" will appear in the display.
  4. Press "1" on the number keypad to turn the sound Off.
  5. Press **SETTINGS** to confirm. The sound has now been turned off.
  6. Press **SETTINGS**, and then follow the display prompts to return the sound setting to On.

## DEGREES FAHRENHEIT AND CELSIUS

- The temperature is factory preset to display degrees in Fahrenheit, but can be changed to Celsius. To do so:
1. Press **Settings**. The various Options will appear in the display.
  2. Press "2" on the number keypad. "Temp Unit" and "Fahrenheit" will appear in the display.
  3. Press "1" on the number keypad. "Degree F/C" will appear in the display.
  4. Press "1" on the number keypad to change the temperature unit setting to Celsius.
  5. Press **Settings** to confirm. The temperature unit has been changed.
  6. Press **Settings**, and then follow the display prompts to return to Fahrenheit.

## SABBATH MODE

The oven is factory preset with Sabbath Mode off.

## TO TURN ON/OFF SABBATH MODE

1. Make sure the oven is turned off, and the meat probe is not plugged in. **NOTE:** Sabbath mode cannot be set when the oven is on. The oven will not recognize the meat probe while in Sabbath mode. If you do not select a time, Sabbath Mode will default to 12 hours. You can set Sabbath Mode time up to 72 hours.
2. Press **Settings**, press **Start** to go to the next screen, and then press "7."
3. Press "1" to toggle between On/Off.
4. Press **Settings** again to enable Sabbath mode. The only cooking function that works while the oven is set to Sabbath mode is Bake.

# OPERATION

## TO BAKE WHILE THE OVEN IS IN SABBATH MODE

1. Turn on Sabbath mode from Settings menu.
2. Enter the desired oven temperature by pressing the numbered keypad.
3. After selecting a temperature, you have the option to set a Cook Time and Start Time before pressing Start. See "Cook Time" and "Start Time."
4. Press Start. Pressing Start activates Sabbath mode.

## ONLY THE CANCEL CONTROL IS FUNCTIONAL

- Press Cancel twice to exit Sabbath mode and resume normal oven operation. The display will return to the time-of-day.
- If there is a power failure while the oven is in Sabbath mode, the oven will exit Sabbath mode and resume in normal mode when power is restored.

## LANGUAGE

1. Press Settings and Press Start.
2. Press "6" on the number keypad.
3. Choose your preferred language.
4. Press Settings to confirm.
  - **NOTE:** The default language for the oven is English.

## BRIGHTNESS

1. Press Settings and Press Start.
2. Press "8" on the number keypad. "Brightness" and "High" will appear in the display.
3. Press "1" to toggle between High/Low.
4. Press Settings to confirm.

## CALIBRATION

See the "Oven Temperature Control" section on page 17.

## DEMO MODE

1. Press Settings and Press Start.
2. Press "9" on the number keypad. "Demo Mode" and "Off" will appear in the display.
3. Press "1" to toggle between On/Off.
4. Press Settings to confirm.
  - **NOTE:** Oven does not heat in Demo Mode. The display counts down quickly.

# OPERATION

## BEFORE USING THE OVEN

1. Select Bake cooking mode.
2. Set temperature to 500° F.
3. Allow the oven to operate for 30 minutes with the door closed and no food in the oven.  
**NOTE:** Any odor that may be detected during this initial use is due to the evaporation of substances used to protect the oven during storage and shipping.
4. Turn off the oven and allow the oven to cool.

## GENERAL

- **IMPORTANT:** Do not place anything, including dishes, foil, and oven trays, on the bottom of the oven when it is in operation to avoid damaging the enamel.
1. Place bakeware with food on one or both of the shelves provided with the oven.
  2. Press the Oven Mode control for the desired oven function.
  3. Use the number keypad to enter the oven temperature.
  4. Press Start.

## PREHEATING THE OVEN

- Preheat the oven when using the Bake, Convection Bake, and Convection Roast modes by choosing the desired oven temperature following the same Cook Time steps detailed on previous pages.
- Selecting a higher temperature does not shorten the preheat time.
- Preheating is necessary for good results when baking cakes, cookies, pastries, and breads.
- Preheating will help to sear roasts and seal in meat juices.
- Place oven racks in their proper position before preheating.
- While the oven is preheating, "Low" will be displayed for 2 to 4 minutes until it reaches the minimum temperature of 170°F, after which the temperature display will rise.
- It will take anywhere from 5 to 15 minutes for the desired cooking temperature to be reached. A sound will chime 3 times once done preheating.

## OPERATIONAL SUGGESTIONS

- Use the cooking and baking charts provided in this manual as a guide.
- Do not set pans on the open oven door.
- Use the interior oven lights to view the food through the oven door window rather than opening the door frequently.



# OPERATION

## TEMPERATURE PROBE

- Use an oven mitt to remove the temperature probe.
- Do not touch broil element.
- Failure to do these things can result in burns.
- The temperature probe monitors the internal food temperature, which is frequently used as an indicator of doneness especially for meats and poultry, and turns off the oven when the internal food temperature reaches the programmed temperature.
- The temperature probe will work with all oven modes except for the Warm/Proof, Sabbath, and Self-Clean modes.

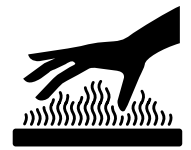

**BURN HAZARD**



**WARNING**

Always unplug and remove the temperature probe from the oven when removing the food.

## TO USE THE TEMPERATURE PROBE

1. Insert the probe into the food. **NOTE:** For meats, the probe tip should be inserted into the center of the thickest part of the meat. Make sure that the probe tip is not into the fat or touching bone.
2. Place the food into the oven. Keeping the temperature probe as far away from a heat source as possible, plug the temperature probe into the oven outlet. Close the oven door.
3. Select the oven mode.
4. Enter the oven temperature by pressing the numbers on the keypad.
5. Press START. The set oven temperature will appear on the display once preheating is complete.
6. Enter the desired internal food temperature by pressing the numbers on the keypad, and then press Start.
  - The internal food temperature can be set between 130°F and 200°F.
  - When the set probe temperature is reached, the oven will turn off.
7. Press Cancel when finished. Unplug the temperature probe and remove food from the oven. The probe icon will remain lit in the display until the probe is unplugged.

# OPERATION

## UTENSILS

- Glass baking dishes absorb heat. Reduce oven temperature 25°F when baking in glass.
- Use pans that produce the desired browning. The type of finish on the pan will help determine the amount of browning that will occur.
  - Shiny, smooth metal, or light non-stick pans reflect heat, resulting in lighter, more delicate browning. Cakes and cookies require this type of utensil.
  - Dark, rough, or dull pans will absorb heat, resulting in a browner, crisper crust. Use this type for pies.
- Do not cook with the empty broiler pan in the oven, as this could affect cooking performance. Store the broil pan outside of the oven.

## HIGH ALTITUDE BAKING

When cooking at high altitude, cooking times may be extended. Consult a high altitude baking chart online.

## OVEN RACKS



To avoid permanent damage to the porcelain finish, place foodware or bakeware on a rack. Do not place bakeware directly onto the oven door or oven bottom.

- The oven racks can be placed in any of the six height positions with the oven.
- Position racks before turning on the oven.
- Make sure the oven racks are level.
- Oven racks have a stop to keep them from being unintentionally withdrawn fully.

## TO REMOVE OVEN RACKS

Pull rack out to the stop position, raise the front edge, and then lift out.

## TO REPLACE OVEN RACKS

Place oven rack on the wire supports along the sides of the oven. Tilt the front edge up slightly and slide rack to the rear until it clears the stop position. Lower the front and slide the rack into the oven.

# OPERATION

## COMPONENT COOLING FAN

The cooling fan activates during any cooking or Self Clean mode to cool inner components and outer door surfaces. This air is exhausted through the vent located above the oven door. It continues to run until components have cooled sufficiently. The cooling fan operates at double speed in Self Clean and whenever the internal temperature increases.

## OVEN DOOR

To avoid oven door glass breakage:

- Do not close the oven door if the racks are not fully inserted into the oven or if bakeware extends past the front edge of an oven rack.
- Do not set objects on the glass surface of the oven door.
- Do not hit glass surfaces with bakeware or other objects.
- Do not wipe down glass surfaces until the oven has completely cooled.

## OVEN VENTS

- Blocking or covering the oven vents will cause poor air circulation, affecting cooking, cleaning, and cooling results.
- The oven's vent allows fresh air to enter the cooling system.

## OVEN CONDENSATION AND TEMPERATURE

- It is normal for a certain amount of moisture to evaporate from the food during any cooking process. The amount depends on the moisture content of the food.
- The moisture may condense on any surface cooler than the inside of the oven, such as the control panel.
- Your wall oven has an electronic temperature sensor to gauge heat levels more accurately than a mechanical thermostat. Still, as temperature increases and decreases can vary, it is normal to adjust your favorite recipes when cooking in a new oven.

# OPERATION

## OVEN TEMPERATURE CONTROL

- The oven provides accurate temperatures; however, it may cook faster or slower than your previous oven, so the temperature calibration can be adjusted.
- A minus sign means the oven will be cooler by the displayed amount. The absence of a minus sign means the oven will be warmer by the displayed amount.
- Use the following chart as a guide:

ADJUSTMENT (°F)	COOKS FOOD
10°F	A little more
20°F	Moderately more
30°F	Much more
-10°F	A little less
-20°F	Moderately less
-30°F	Much less

## TO ADJUST OVEN TEMPERATURE CALIBRATION

1. Press Settings. The various options will appear in the display.
2. Press number 9 on the keypad. "Calibration" and "Press 3 to Increase/6 to Decrease" will scroll across the display.
3. Press number 3 on the keypad to increase or number 6 to decrease the temperature in 5°F increments. The adjustment can be set between 30°F and -30°F.
4. Press Settings to save the adjustment, and then exit the Temperature menu.

# OPERATION

## OVEN MODES

The illustrations show the heating elements and fans used for each oven mode.

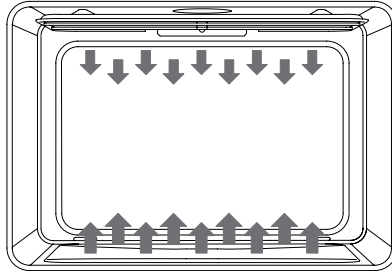

**NOTE:** The lower element is concealed under the oven floor.

## BAKE

- Baking is cooking with heated air. Both upper and lower elements in the oven are used to heat the air but no convection fan is used to circulate the heat.
  - Follow the recipe directions for baking temperature, time, and rack position. Baking time will vary with the temperature of ingredients and the size, shape, and finish of the bakeware.
1. Press Bake to select the bake mode. "Bake" will appear in the display and 350°F will be displayed. "Set Temp or Press Start" will appear in the display.
  2. Press Start if you wish to cook at 350°F, or enter the desired temperature by pressing the number keypad, and then press Start. The temperature can be set from 170°F to 500°F .
    - The temperature can be changed at any time during cooking. Press Cancel to clear the settings. Select Oven Mode, then enter the desired temperature by pressing the number keypad, and then press Start.
    - After selecting an Oven Mode and temperature, you have the option to set a Cook Time and Start Time before pressing Start. See "Cook Time" and "Start Time" sections on previous pages.
  3. Press Cancel when finished baking, and remove food from the oven.

# OPERATION

## BROIL

Broiling uses direct radiant heat from the upper element to cook food. The lower the temperature, the slower the cooking. Thicker cuts and unevenly shaped pieces of meat, fish, and poultry may cook better at lower broiling temperatures.

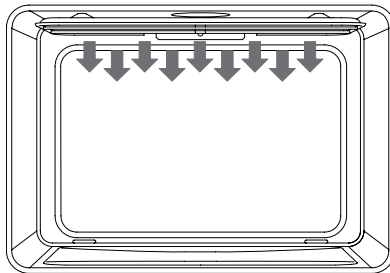

- For best results, use a broiler pan and rack. It is designed to drain juices and help avoid spatter and smoke.
  - For proper draining, do not cover the grid with foil. The bottom of the pan may be lined with aluminum foil for easier cleaning.
  - Trim excess fat to reduce spattering. Slit the remaining fat on the edges to avoid curling.
  - Select HI/550°F Broil for most broiling. Select LO/450°F Broil for low-temperature broiling of longer cooking foods such as poultry to avoid over browning.
  - Pull out oven rack to stop position before turning or removing food. Use tongs to turn food to avoid the loss of juices. Very thin cuts of fish, poultry or meat may not need to be turned.
1. Place the food on the rack in the broiler pan and place pan in the oven. Close the oven door. Preheating is not necessary.
  2. Press Broil for the desired mode. "Broil" and "Set temp or Press Start" will appear in the display, and "550°F" will be displayed.
  3. Press Start if you wish to broil at 550°F, or enter the desired temperature by pressing the number keypad, and then press Start. The temperature can be set from 450°F to 550°F.
  4. "Broil" will appear in the display after Start is pressed.
  5. Press Cancel when finished broiling, and remove food from the oven.
    - The Broil temperature can be changed at any time during cooking. Press Cancel to clear the settings. Select Oven Mode, then enter the desired temperature by pressing the number keypad, and then press Start.
    - After selecting an Oven Mode and temperature, you have the option to set a Cook Time and Start Time before pressing Start. See "Cook Time" and "Start Time" sections on previous pages.

# OPERATION

## WARM/PROOF

The Warm mode keeps hot, cooked foods at serving temperature by utilizing the lower heating element. The Proof mode prepares dough for baking by activating the yeast. Follow the recipe directions as a guide.

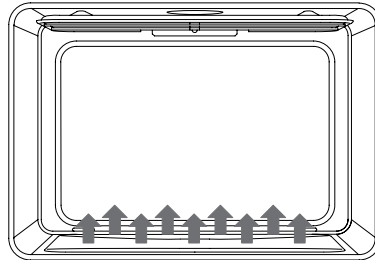

**WARNING**

Do not let food sit in the oven more than one hour before or after cooking. Doing so can result in food poisoning or sickness.

Food must be at serving temperature before placing in the warmed oven. Food may be held up to 1 hour; however, breads and casseroles may become too dry if left in the oven during the Warm function. For best results, cover food.

## WARM

1. Press Warm/Proof. "Warm" and "Set Temp or Press Start" and 140°F will be displayed.
2. Press Start if you want to warm food at 140°F, or enter the desired temperature by pressing the number keypad, and then press Start. The temperature can be set from 140°F to 210°F.
3. "Warm" will appear in the display once Start is pressed. NOTE: After selecting an Oven Mode and temperature, you have the option to set a Cook Time and Start Time before pressing Start. See "Cook Time" and "Start Time" sections on previous pages.
4. Place food in the oven and close the door.
5. Press Cancel when finished and remove food from the oven.

# OPERATION

## PROOF

1. Before proofing, place the dough in a lightly greased bowl and cover loosely with wax paper coated with shortening. Place on second rack from the bottom and close the oven door.
2. Press and hold Warm/Proof for 3 seconds. "Proof" and "Set Temp or Press Start," and 100°F (38°C) will be displayed.
3. Press Start if you want to Proof dough at 100°F, enter the desired temperature by pressing the number keypad, and then press Start. The temperature can be set from 80°F to 120°F .
4. "Proof" will appear in the display, once Start is pressed. NOTE: After selecting an Oven Mode and temperature, you have the option to set a Cook Time and Start Time before pressing Start. See "Cook Time" and "Start Time" sections on previous pages.
5. Let the dough rise until nearly doubled in size, checking after 20-25 minutes. Proofing time may vary depending on dough type and quality.
6. Press Cancel when finished proofing.
7. Before second proofing, shape the dough, place it in baking pan(s), and cover loosely with plastic wrap coated with cooking spray. Follow the same placement and control steps above. Before baking, remove the plastic wrap.



# OPERATION

## CONVECTION

- During convection cooking, the fan provides hot air circulation throughout the oven. The movement of heated air around the food can help speed up cooking by penetrating the cooler outer surfaces.
- In Convection mode, the ring element, bake and broil elements, and the fan operate to heat the oven. If the oven door is opened during convection cooking or preheating, the fan turns off immediately and the element(s) will turn off after 30 seconds. Once the door is closed, the element(s) will turn back on.

## CONVECTION FAN

- The convection fan operates during any convection mode. When the oven is operating in convection mode, the fan will turn off automatically when the door is opened. The convection fan always runs during the preheat time.

## ADVANTAGES OF CONVECTION COOKING

- Saves time and energy.
- Even baking, browning, and crisping are achieved.
- During roasting, juices and flavors are sealed in while the exterior is crisp.
- Yeast breads are lighter, more evenly textured, more golden, and crustier.
- Air-leavened foods such as cream puffs, soufflés and meringues come out higher and lighter.
- Baking on multiple racks at the same time with even results is possible.
- Evenly dehydrates herbs, fruits, and vegetables.
- Requires no specialized bakeware.
- Convection broiling allows for extraordinary grilling with thicker cuts of food.

# OPERATION

## CONVECTION BAKE

Use Convection bake for single or multiple rack baking. When convection baking, reduce your recipe baking temperature by 25°F.

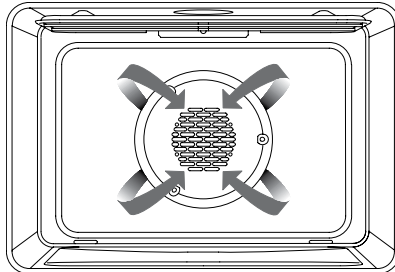

## TO SET CONVECTION BAKE

1. Press Convec. "Convection" and "Press 1-3 To Choose" will appear in the display.
2. Press number 1 on the keypad. "Convect Bake" and "Set Temp or Press Start" and 325°F will be displayed.
3. Press Start if you wish to convection bake at 325°F, or enter the desired temperature by pressing the number keypad, and then press Start. The temperature can be set from 170°F to 500°F.

**NOTE:** After selecting an Oven Mode and temperature, you have the option to set a Cook Time and Start Time before pressing Start. See "Cook Time" and "Start Time" sections on previous pages.

4. The oven will begin preheating once Start is pressed. A tone will sound when the oven is at the set temperature.
5. Place the food in the oven and close the oven door when preheat is completed.
6. Press Cancel when finished and remove food from the oven.

# OPERATION

## CONVECTION BROIL

When convection broiling, enter your normal broiling temperature. The oven door must be closed when using Convection Broil. It is not necessary to preheat the oven for Convection Broil.

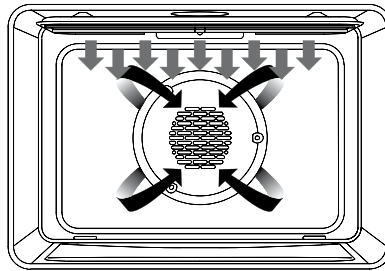

1. Place the food in the oven and close the oven door.
2. Press Convec. "Convection" and "Press 1-4 To Choose" will be displayed.
3. Press number 2 on the keypad. "Convect Broil" and "Set Temp or Press Start" and 450°F will be displayed.
4. Press Start if you wish to broil at 450°F, enter the desired temperature by pressing the number keypad, and then press Start. The temperature can be set from 170°F to 550°F.

**NOTE:** After selecting an Oven Mode and temperature, you have the option to set a Cook Time and Start Time before pressing Start. See "Cook Time" and "Start Time" sections on previous pages.

5. "Convect Broil" will be displayed once Start is pressed.
6. Press Cancel when finished, and remove food from the oven.

# OPERATION

## CONVECTION ROAST

When convection roasting, enter your normal roasting temperature. The roasting time should be 15-30% less than in conventional cooking. It is not necessary to preheat the oven for the Convection Roast function.

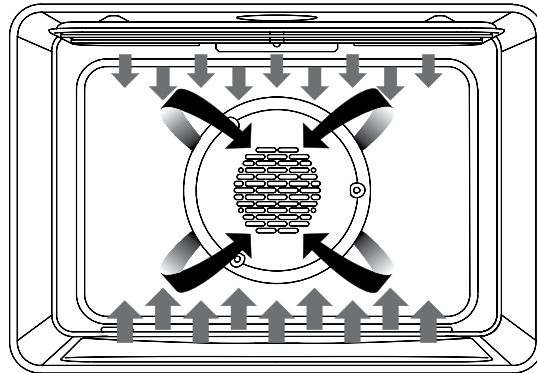

1. Place the food in the oven and close the oven door.
2. Press Convec. "Convection" and "Press 1-4 To Choose" will be displayed.
3. Press number 3 on the keypad. "Convect Roast," "Set Temp or Press Start", and 325°F will be displayed.
4. Press Start if you wish to convection roast at 325°F, enter the desired temperature by pressing the number keypad, and then press Start. The temperature can be set from 170°F to 500°F.

**NOTE:** After selecting an Oven Mode and temperature, you have the option to set a Cook Time and Start Time before pressing Start. See "Cook Time" and "Start Time" sections on previous pages.

5. "Convect Roast" will be displayed once Start is pressed.
6. Press Cancel when finished and remove food from the oven.

## STEAM CLEAN FUNCTION

- Test method: mix the ingredients for Steam Clean (85% water, 10% white vinegar, 5% dish washing liquid), evenly spray inside the oven, spray on the door glass, then pour 1.5 oz of water on the bottom panel.
- Press the key to start the Convection Roast mode and set the temperature at 248°F. After 20 minutes, turn off the oven, wait until cool, and wipe with a damp cloth.

# OPERATION

## CONVECTION CONVERSION

- Convection Conversion can be used to convert from conventional cooking to convection cooking. This function will automatically convert the cooking temperature and cooking time to recommended cooking settings.
- As a result, the cooking temperature is lower and the cooking time is shorter. Options that can be selected include Meats, Baked Goods, or Others.
- When using Convection Conversion, enter the normal cooking temperature and time.
- The oven door must be closed before setting Convection Conversion.

## MEATS (ONLY)

- It is not necessary to preheat the oven for the Convection Conversion Meats option. Preheating can cause overcooking. If preheating is required for the recipe, add 15 minutes to the Cook Time, and place food in the oven at the appropriate time.
1. Place food in the oven and close the door.
  2. Press Convec. "Convection and Press 1-4 To Choose" will be displayed.
  3. Press number 4 on the keypad. "Convect Convert and Press 1-3 To Choose" will be displayed.
  4. Press number 2 on the keypad. "Meats" and 350°F will be displayed.
  5. Enter your normal roasting temperature by pressing the number keypad.
  6. Enter your normal Cook Time. See "Cook Time," and then press Start.

## BAKED GOODS AND OTHERS (ONLY)

1. Start preheating. Once the oven is preheated to the set temperature, a chime will sound. Place the food in the oven and close the oven door.
2. At the end of the set cooking time, the oven will turn off automatically. The alert tone will sound, and "Cooking Complete" will appear in the display.
3. Press Cancel when finished and remove food from the oven.

# OPERATION

## BAKE TIPS

- For best results, bake food on a single rack with at least 1"-1 1/2" (2.5-3 cm) space between utensils and oven walls.
- Use one rack when selecting the Bake mode.
- Check for doneness at the minimum time.
- Use metal bakeware (with or without a nonstick finish), heatproof glass, glass-ceramic, pottery, or other utensils suitable for the oven.
- When using heatproof glass, reduce temperature by 25°F from recommended temperature.
- Use baking sheets with or without sides depending on recipe.
- Dark metal pans and those with nonstick coatings will cook faster with more browning, while insulated bakeware will slightly lengthen the cooking time for most foods.
- Do not use aluminum foil or disposable trays to line any part of the oven. Foil is an excellent heat insulator and heat will be trapped beneath it. This will alter the cooking performance and can damage the finish of the oven.
- Avoid using the opened door as a shelf to place pans.
- See Troubleshooting on page 43 for tips for baking and roasting problems.

FOOD ITEM	RACK POSITION	TEMP °F (PREHEATED OVEN)	TIME (MIN.)
CAKE			
Cupcake	2	350°F	19-22
Bundt cake	1	350°F	40-45
Angel food	1	350°F	35-39
PIE			
2 crust, fresh 9"	2	375-400°F	45-40
2 crust, frozen fruit, 9"	2	375°F	68-78
COOKIES			
Sugar	2	350-375°F	8-10
Chocolate chip	2	350-375°F	8-13
Brownies	2	350°F	29-36
BREADS			
Yeast bread, 9" x 5"	2	375°F	18-22
Yeast rolls	2	375-400°F	12-15
Biscuits	2	375-400°F	7-9
Muffins	2	425°F	15-19
PIZZA			
Frozen	2	400-450°F	23-26
Fresh	2	475°F	15-18

# OPERATION

## CONVECTION BAKE TIPS

- Reduce recipe baking temperatures by 25°F.
- For best results, foods should be cooked uncovered in low-sided pans to take advantage of the forced air circulation. Use shiny aluminum pans for best results unless otherwise noted in recipe.
- Heatproof glass or ceramic can be used. Reduce temperature by another 25°F when using heatproof glass dishes for a total reduction of 50°F.
- Dark metal pans may be used. Note that food may brown faster when using dark metal bakeware.
- The number of racks used is determined by the height of the food to be cooked.
- Baked items, for the most part, cook extremely well in convection. Don't try to convert recipes such as custards, quiches, pumpkin pie, or cheesecakes, which do not benefit from the convection-heating process. Use the regular Bake mode for these foods.
- Multiple rack cooking for oven meals is done on rack positions 1, 2, 3, 4, and 5. All six racks (see Figure 1) can be used for cookies, biscuits, and appetizers.
  - 2-rack baking: Use positions 1 and 3.
  - When baking four cake layers at the same time, stagger pans so that one pan is not directly above another. For best results, place cakes on front of upper rack and back of lower rack (see Figure 2). Allow 1" - 1 1/2" (2.5 - 3 cm) air space around pans.

Figure 1

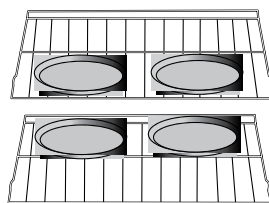
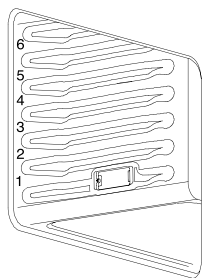

Figure 2

- Converting your own recipe can be easy. Choose a recipe that will work well in convection.
- Reduce the temperature and cooking time if necessary. It may take some trial and error to achieve a perfect result. Keep track of your technique for the next time you want to prepare the recipe using convection.
- See Troubleshooting on page 43 for tips for baking and roasting problems.

# OPERATION

## FOODS RECOMMENDED FOR CONVECTION BAKE MODE

- Appetizers, Biscuits, Coffee Cakes
- Cookies (2 to 4 racks), Yeast Breads
- Cream Puffs, Popovers
- Casseroles, One-Dish Entrées
- Oven Meals (rack positions 1, 2, 3)
- Air-Leavened Foods (Soufflés, Meringue, Meringue-Topped Desserts, Angel Food Cakes, Chiffon Cakes)

## CONVECTION BAKE CHART

Reduce standard recipe temperature by 25°F for Convection Bake. Temperatures have been reduced in this chart.

FOOD ITEM	RACK POSITION	TEMP °F (PREHEATED OVEN)	TIME (MIN.)
CAKE			
Cupcake	2	325°F	20-22
Bundt cake	1	325°F	43-50
Angel food	1	325°F	43-47
PIE			
2 crust, fresh 9"	2	350-400°F	40-52
2 crust, frozen fruit, 9"	2	350°F	68-78
COOKIES			
Sugar	2	325-350°F	8-10
Chocolate chip	2	325-350°F	8-13
Brownies	2	325°F	29-36
BREADS			
Yeast bread, 9x5	2	350°F	18-22
Yeast rolls	2	350-375°F	12-15
Biscuits	2	375°F	8-10
Muffins	2	400°F	17-21
PIZZA			
Frozen	2	375-425°F	23-26
Fresh	2	450°F	15-18



# OPERATION

## CONVECTION ROAST TIPS

- Do not preheat for Convection Roast.
- Roast in a low-sided, uncovered pan.
- When roasting whole chicken or turkey, tuck wings behind back and loosely tie legs with kitchen string.
- Use the 2-piece broil pan for roasting uncovered.
- Use an oven mitt to remove temperature probe.
- Do not touch the broil element. Failure to do so can result in burns.
- Use the probe or a meat thermometer to determine the internal doneness upon reaching the end temperature (see cooking chart on the next page).
- Double-check the internal temperature of meat or poultry by inserting meat thermometer into another position.
- Large poultry may also need to be covered with foil (and pan roasted) during a portion of the roasting time to prevent over-browning.
- The minimum safe temperature for stuffing in poultry is 165°F.
- After removing the item from the oven, cover loosely with foil for 10 to 15 minutes before carving if necessary to increase the final temperature by 5°F to 10°F.

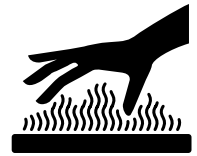

**BURN HAZARD**

# OPERATION

MEAT	WEIGHT (LB)	OVEN TEMP °F	RACK POSITION	TIME (MIN. PER LB)	INTERNAL TEMP. °F
<b>BEEF</b>					
Rib roast	4-6	325°F	2	16-20 18-22	145°F medium rare 160°F medium
Rib eye roast (boneless)	4-6	325°F	2	16-20 18-22	145°F medium rare 160°F medium
Rump, Eye, Trip, Sirloin (boneless)	3-6	325°F	2	16-20 18-22	145°F medium rare 160°F medium
	3-6	325°F	2	16-20 18-22	145°F medium rare 160°F medium
Tenderloin roast	2-3	400°F	2	15-20	145°F medium rare
<b>PORK</b>					
Loin roast (boneless or bone-in)	5-8	350°F	2	16-20	160°F medium
Shoulder	3-6	350°F	2	20-25	160°F medium
<b>POULTRY</b>					
Chicken whole	3-4	375°F	2	18-21	180°F
Turkey, not stuffed	12-15	325°F	1	10-14	180°F
Turkey, not stuffed	16-20	325°F	1	9-11	180°F
Turkey, not stuffed	21-25	325°F	1	6-10	180°F
Turkey breast	3-8	325°F	1	15-20	170°F
Cornish hen	1-1.5	350°F	2	45-75 total	180°F
<b>LAMB</b>					
Half leg	3-4	325°F	2	22-27 28-33	160°F medium 170°F well
Whole leg	6-8	325°F	1	22-27 28-33	160°F medium 170°F well

# OPERATION

## CONVECTION BROIL TIPS

- Place rack in the required position needed before turning on the oven.
- Use Convection Broil mode with the oven door closed.
- Do not preheat oven.
- Use the 2-piece broil pan.
- Turn meats once halfway through the cooking time (see chart below).

FOOD AND THICKNESS	RACK POSITION	BROIL SETTING °F	INTERNAL TEMP °F	TIME SIDE 1 (MIN)	TIME SIDE 2 (MIN)
<b>BEEF</b>					
Steak (1.5" or more)					
Medium Rare	4	450°F	145°F	9-12	8-10
Medium	4	450°F	160°F	11-13	10-12
Well	4	450°F	170°F	18-20	16-17
Hamburgers (more than 1")					
Medium	4	550°F	160°F	8-11	5-7
Well	4	550°F	170°F	11-13	8-10
<b>POULTRY</b>					
Chicken quarters	4	450°F	180°F	16-18	10-13
Chicken halves	4	450°F	180°F	25-27	15-18
Chicken breasts	4	450°F	170°F	13-15	9-13
<b>PORK</b>					
Pork chops (1.25" or more)	4	450°F	160°F	12-14	11-13
Sausage - fresh	4	450°F	160°F	4-6	3-5

- Broiling and convection broiling times are approximate and may vary slightly. Cooking times also depend on the thickness and the starting temperature of the meat before cooking.

# OPERATION

## DEHYDRATE TIPS

Circulating heated air at a lower temperature slowly removes the moisture for food preservation.

- Oven temperature for dehydrating is between 120°F to 160°F.
- Multiple racks can be used simultaneously.
- Some foods require as much as 14-15 hours to fully dehydrate. Consult a food preservation book for specific times for various foods.
- This mode is suitable for a variety of fruits, vegetables, herbs, and meat strips.
- Drying screens can be purchased at specialty kitchen shops.
- By using paper towels, some food moisture can be absorbed before dehydrating begins (such as with sliced tomatoes or sliced peaches).

FOOD	PREPARATION	APPROXIMATE DRYING TIME (HRS)	TEST FOR DONENESS
<b>FRUIT</b>			
Apple	Dipped in 1/4 cup lemon juice and 2 cups water, 1/4 slices	11-15	Slightly pliable
Bananas	Dipped in 1/4 cup lemon juice and 2 cups water, 1/4 slices	11-15	Slightly pliable
Cherries	Wash and towel dry. For fresh cherries, remove pits	10-15	Pliable, leathery, chewy
Orange peels and slices	1/4 slices of orange; orange part of skin thinly peeled from oranges	Peels: 2-4 Slices: 12-16	Orange peel: dry and brittle Orange slices: skins are dry and brittle, fruit is slightly moist
Pineapple rings	Towel dry	Canned: 9-13 Fresh: 8-12	Soft and pliable
Strawberries	Wash and towel dry. Slice 1/2" thick, skin (outside) down on rack	12-17	Dry, brittle
<b>VEGETABLE</b>			
Peppers	Wash and towel dry. Remove membrane of pepper, coarsely chop about 1" pieces	16-20	Leathery with no moisture inside
Mushrooms	Wash and towel dry. Cut off stem end. Cut into 1/8" slices	7-12	Tough and leathery, dry
Tomatoes	Wash and towel dry. Cut thin slices, 1/8" thick, dry well	16-23	Dry, brick red color
<b>HERBS</b>			
Oregano, sage, parsley, thyme, and fennel	Rinse and dry with paper towel	Dry at 120°F 3-5 hours	Crisp and brittle
Basil	Use basil leaves 3 to 4 inches from the top. Spray with water, shake off moisture, and pat dry	Dry at 120°F 3-5 hours	Crisp and brittle

# OPERATION

## BROIL TIPS

- Place rack in the required position needed before turning on the oven.
- Use Broil mode with the oven door closed.
- Preheat oven for 5 minutes before use.
- Use the 2-piece broil pan.
- Turn meats once halfway through the cooking time (see chart below).

FOOD AND THICKNESS	RACK POSITION	BROIL SETTING °F	INTERNAL TEMP °F	TIME SIDE 1 (MIN)	TIME SIDE 2 (MIN)
<b>BEEF</b>					
Steak (3/4"-1")					
Medium Rare	5	5	145°F	5-7	4-6
Medium	5	5	160°F	6-8	5-7
Well	5	5	170°F	8-10	7-9
Hamburgers (3/4"-1")					
Medium	4	5	160°F	8-11	6-9
Well	4	5	170°F	10-13	8-10
<b>POULTRY</b>					
Breast (bone in)	4	4	170°F	10-12	8-10
Thigh (very well done)	4	3	180°F	28-30	13-15
<b>PORK</b>					
Pork chops (1")	5	5	160°F	7-9	5-7
Sausage - fresh	5	5	160°F	5-7	3-5
Ham slice (1/2')	5	5	160°F	4-6	3-5
<b>LAMB</b>					
Chops (1")					
Medium rare	5	5	145°F	5-7	4-6
Medium	5	5	160°F	6-8	4-6
Well	5	5	170°F	7-9	5-7
<b>BREAD</b>					
Garlic bread, 1" slices	3	5		4-6	

- Broiling and convection broiling times are approximate and may vary slightly. Cooking times also depend on the thickness and the starting temperature of the meat before cooking.

# OPERATION

FOOD SERVICE TEMPERATURE GUIDELINES FROM FSIS USDA FOOD SAFETY & INSPECTION SERVICE	
140°F	Ham, precooked (to reheat)
145°F	Fresh beef, veal, lamb (medium rare)
160°F	Ground meat & meat mixtures (beef, pork, veal lamb)
160°F	Fresh beef, veal, lamb (medium)
160°F	Fresh pork (medium)
160°F	Egg dishes
160°F	Ground meat & meat mixtures (turkey, chicken)
165°F	Stuffing (cooked alone or in bird)
165°F	Leftovers & casseroles
170°F	Fresh beef, veal, lamb (well done)
170°F	Poultry breast
170°F	Fresh pork (well done)
180°F	Chicken and turkey (whole)
180°F	Poultry (thighs and wings)
180°F	Duck and goose

- Eggs (alone, not used in a recipe) – cook until yolk and white are firm.
- On models without a temperature probe, use a meat thermometer to determine whether meat, poultry, and fish are cooked to the desired degree of doneness. The internal temperature, not appearance, should be used to determine doneness.

# MAINTENANCE AND CLEANING

## GENERAL CLEANING



Before cleaning, make sure all controls are off and the oven is cool. Always follow the instructions printed on the label of cleaning products.

1. Locate the number of the part to be cleaned in the following illustration.
2. Find the part name in the chart.
3. Match the letter on the cleaning method on the key below with the chart on the next page.

PART		CLEANING METHOD
1	Control panel	C-G
2	Door cooling vent	E
3	Side trim	D
4	Bottom trim	D
5	Door frame	E
6	Door handle	G
7	Interior door window	F
8	Door front	C-G
9	End caps	D
10	Interior oven door	E
11	Oven front frame	E
12	Oven cavity	E
13	Door gasket	B
14	Oven cooling vents	D
15	Oven rack	A
16	Broiler pan rack	E
17	Broiler pan	E
18	Temperature probe	A

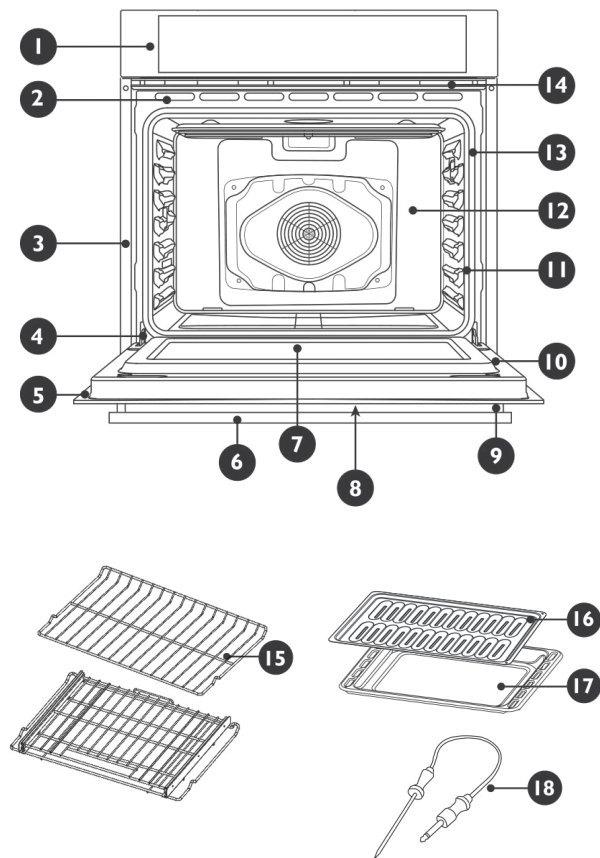

# MAINTENANCE AND CLEANING

PART		CLEANING METHOD
A	Chrome plated	Wash with hot sudsy water. Rinse thoroughly and dry. Or, gently rub with Soft Scrub <sup>®</sup> , Bon-Ami <sup>®</sup> , Comet <sup>®</sup> , Ajax <sup>®</sup> , Brillo <sup>®</sup> , or S.O.S. <sup>®</sup> pads as directed. Easy Off <sup>®</sup> or Dow <sup>®</sup> oven cleaners (cold oven formula) can be used, but may cause darkening and discoloration. Racks may be cleaned in the oven during the Self Clean mode. However, chromed racks will lose their shiny finish and permanently change to a metallic gray.
B	Fiberglass knit	DO NOT CLEAN OVEN DOOR GASKET — a proper seal is essential for oven to function.
C	Glass	Spray Windex <sup>®</sup> or Glass Plus <sup>®</sup> onto a cloth first, then wipe to clean. Use Fantastik <sup>®</sup> or Formula409 <sup>®</sup> to remove grease spatters.
D	Painted	Clean with hot sudsy water or apply Fantastik <sup>®</sup> for Formula <sup>®</sup> first to a clean sponge or paper towel and wipe clean. Avoid using powdered cleansers and steel wool pads.
E	Porcelain	Immediately wipe up acidic spills like fruit juice, milk, and tomatoes with a dry towel. Do not use moistened sponge/towel on hot porcelain. When cool, clean with hot sudsy water or apply Bon-Ami <sup>®</sup> or Soft Scrub <sup>®</sup> to a damp sponge. Rinse and dry. For stubborn stains, gently use Brillo <sup>®</sup> or S.O.S. <sup>®</sup> pads. It is normal for porcelain to craze (form fine lines) with age due to exposure from heat and food soil.
F	Reflective glass	Clean with hot sudsy water and sponge or plastic scrubber. Rub stubborn stains with vinegar, Windex <sup>®</sup> , ammonia, or Bon-Ami <sup>®</sup> . DO NOT USE HARSH ABRASIVES.
G	Stainless	Always wipe or rub with the grain. Clean with a soapy sponge then rinse and dry. Or wipe with Fantastik <sup>®</sup> or Formula 409 <sup>®</sup> sprayed onto a paper towel. Protect and polish with Stainless Steel Magic <sup>®</sup> and a soft cloth. Remove water spots with a cloth dampened with white vinegar. Use Zud <sup>®</sup> , Cameo <sup>®</sup> , Bar Keeper's Friend <sup>®</sup> , or RevereWare Stainless Steel Cleaner <sup>®</sup> , to remove heat discoloration.



# MAINTENANCE AND CLEANING

## OVEN FINISHES / CLEANING METHODS

- The entire oven can be safely cleaned with a soapy sponge, rinsed and dried. If stubborn soil remains, follow the recommended cleaning methods below.
- Always use the mildest cleaner that will do the job.
- Rub metal finishes in the direction of the grain.
- Use clean, soft cloths, sponges, or paper towels.
- Rinse thoroughly with minimal water so it does not drip into door slots.
- Dry to avoid water marks. The cleaners listed on the previous page indicate types of products to use and are not being endorsed. Use all products according to package directions.

## AUTOMATIC SELF-CLEANING

- Do not touch the oven during the Self Clean cycle.
- Keep children away from oven during Self Clean cycle.
- Failure to do these things can result in burns.
- This oven features a self-cleaning function that eliminates the need to manually scrub the oven interior. During self-cleaning, the oven uses very high temperatures, burning soil to a powdery ash.



Some species of birds are extremely sensitive to the fumes given off during the Self Clean cycle. Exposure to the fumes may result in death to certain birds.

Always move birds to another closed and well-ventilated room.

- Keep the kitchen well ventilated during the Self Clean cycle to help get rid of heat, odors, and smoke.
- It is common to see smoke and/or an occasional flame-up during the Self Clean cycle, depending on the content and amount of soil remaining in the oven. If a flame persists, turn off the oven and allow it to cool before opening the door to wipe up the excessive food soil.
- Do not block the oven vent(s) during the Self Clean cycle. Air must be able to move freely. See "Oven Vents" on page 15.
- Do not clean, rub, damage, or move the oven door gasket.
- The door latch is automatically activated after selecting the Self Clean cycle. "Auto Lock" will appear in the display. This ensures that the oven door cannot be opened while the oven interior is at clean temperatures.

# MAINTENANCE AND CLEANING

- The oven is preset for a 2.5-hour clean cycle; however, the time can be changed. Suggested clean times are 2 hours for light soil and between 3 hours and 3.5 hours for average to heavy soil.
- Clean mode stops automatically at the end of the set cleaning time.
- When the oven heat drops to a safe temperature, the automatic door lock will release and the door can be opened.
- The oven light does not operate during Self Clean mode.

## BEFORE SELF-CLEANING

1. Remove all utensils and bakeware.
2. Remove oven racks. If chromed racks are left in the oven during the Self Clean cycle, they will permanently lose the shiny finish and change to a dull dark finish. See "Oven Finishes/Cleaning Methods" for proper care on previous pages.
3. Wipe up any soft soil spills and grease with paper towels. Excess grease will cause flames and smoke inside the oven during self-cleaning.
4. Be sure oven interior lights are turned off and the light bulbs and lens covers are in place.
5. Some areas of the oven such as the oven door edge, oven door window, oven front frame, and up to 1/2" (2-3 cm) inside the frame do not get hot enough during the cleaning cycle for soil to burn away and must be cleaned by hand.
6. BEFORE the cycle begins, clean oven interior using a soapy sponge or plastic scrubber and a solution of detergent and hot water. Rinse and dry all areas thoroughly. **NOTE:** Do not rub or clean the oven door gasket.

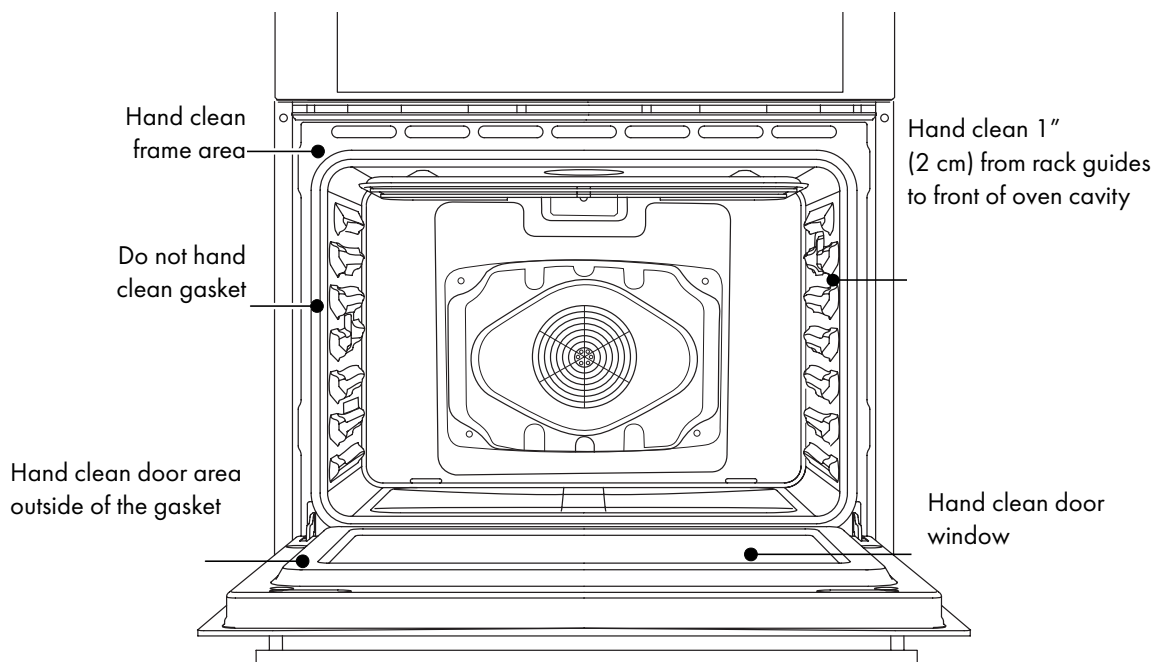

# MAINTENANCE AND CLEANING

## SELF CLEAN CYCLE

A minimum 24-hour wait is recommended between cleaning cycles.

## TO SELF CLEAN

1. Close the oven door.
2. Press Self Clean. "Remove Racks" will appear in the selected oven text area of the display.
3. "2:00 3:00 3:30" will appear in the display.
4. Use the number keypad to select the clean level. Select 1-3.
5. If you want to delay the start of the self-cleaning cycle, press Start Time, and then set a time by pressing the number keypad. The oven door will remain locked if the oven is above a safe temperature and will unlock when the oven has cooled.
6. Press Start. After the door is locked, "Self Clean" will scroll in the selected text area until the clean cycle is finished. When the Self Clean cycle ends, "Complete" appears in the display and the oven door unlocks. **NOTE:** Self Clean can be canceled by pressing Cancel. The oven door will remain locked if the oven is above a safe temperature and will unlock when the oven has cooled.
7. Once the oven has completely cooled, remove ash with a damp cloth. **NOTE:** To avoid breaking the glass, do not apply a cool, damp cloth to the inner door glass until it has cooled completely.

# MAINTENANCE AND CLEANING

## OVEN DOOR REMOVAL

For normal oven use, there is no need to remove the oven door. However, should it become necessary to remove the door, follow the instructions in this section.

### IMPORTANT:

- Make sure oven is cool and that power to the oven has been turned off before removing the door.
- The oven door is heavy and fragile, and the door front is glass. To avoid oven door glass breakage, use both hands and grasp only the sides of the oven door to remove. Do not grasp the handle.
- Be sure both hinge levers are securely in place before removing the door.
- Do not force door open or closed.



Scan to follow along with a video.

# MAINTENANCE AND CLEANING

## REMOVE THE OVEN DOOR

1. Open the door completely and rotate the hinge latches forward from the locked position (below left) to the unlocked position (below right) on each side.

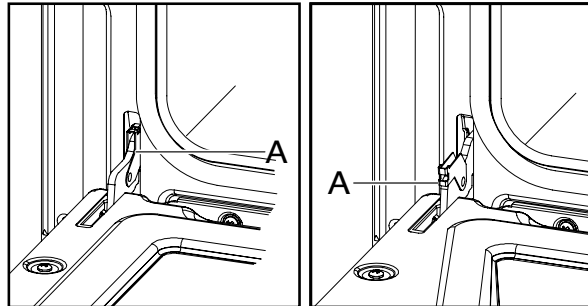

A. Hinge bracket

2. Holding the door firmly, close the oven door completely.
3. Grasping both sides, lift up on the oven door while pushing it closed, and then pull it away from the door frame.
4. Place the door in a protected location.

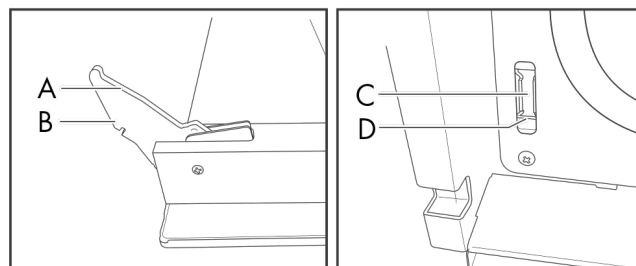

A. Upper arm  
B. Recess

C. Slots  
D. Lip

## TO REPLACE THE OVEN DOOR

1. Holding the door firmly, insert the upper arms of both hinges into the slots. The recesses must hook on the lips.
2. Open the oven door. **NOTE:** You should hear a “click” sound when the door is correctly in place.
3. Move the hinge latch on each side back into the locked position.
4. Open and close the door to test that it operates freely. If it does not, repeat the door removal and replacement process.
5. Close and open the door slowly to assure that it is correctly and securely in place.

# MAINTENANCE AND CLEANING

## REPLACING AN OVEN LIGHT

- Make sure the oven and lights are cool and power to the oven has been turned off before replacing the light bulb(s).
- The lenses must be in place when using the oven. The lenses serve to protect the light bulb from breaking.
- The lenses are made of glass. Handle carefully to avoid breakage.
- Failure to do so could result in death, electric shock, cuts or burns.
- The oven light is a standard 25 watt (G9) halogen bulb.



**WARNING** Before replacing the bulb make sure the oven is cool and the controls are turned off.

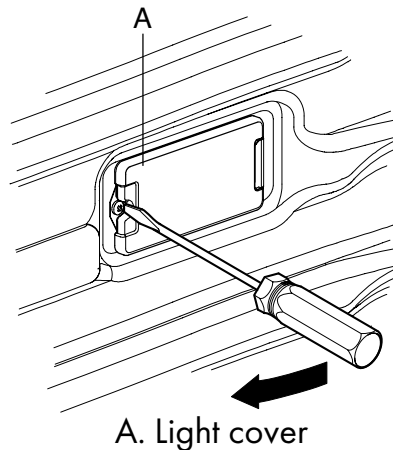

1. Disconnect power at the main power supply (fuse or breaker box).
2. Using a Phillips-head screwdriver, remove the screw, and then remove the cover.
3. Remove the burned out bulb from the socket. **NOTE:** To avoid damage or decreasing the life of the new bulb, do not touch bulb with bare fingers. Wear gloves or use a tissue when replacing the light bulb.
4. Replace the bulb, and then rescrew the bulb cover.

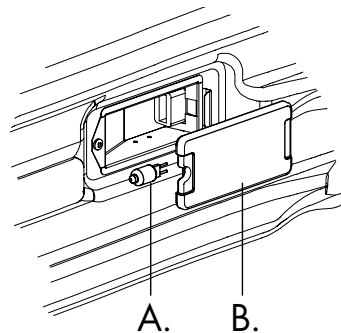

A. Light bulb  
B. Light cover

5. Reconnect power at the main power supply (fuse or breaker box).

# TROUBLESHOOTING

POSSIBLE ISSUE	POSSIBLE CAUSE
Food browns unevenly	Oven not preheated
	Aluminum foil on oven rack or oven bottom
	Baking utensil too large for recipe
	Pans touching each other or oven walls
Food too brown on bottom	Oven not preheated
	Using glass, dull or darkened metal pans
	Incorrect rack position
	Pans touching each other or oven walls
Food is dry or has shrunk excessively	Oven temperature too high
	Baking time too long
	Oven door opened
	Pan size too large
Pie crusts do not brown on bottom or crust is soggy	Oven temperature too low
	Oven not preheated
	Oven door opened frequently
	Tightly sealed with aluminum foil
	Pan size too small
Cake is pale, flat and may not be done inside	Oven temperature too low
	Incorrect baking time
	Cake tested too soon
	Oven door opened too often
	Pan size too small

# TROUBLESHOOTING

POSSIBLE ISSUE	POSSIBLE CAUSE
Cake is high in middle with crack on top	Oven temperature too high
	Baking time too long
	Pans touching each other or oven walls
	Incorrect rack position
	Pan size too small
Pie crust edges too brown	Oven temperature too high
	Edges of crust too thin

ISSUE	POSSIBLE CAUSE	TROUBLESHOOTING
Excessive moisture	Oven was not properly preheated.	When using bake mode, preheat the oven first. Convection Bake and Convection Roast will eliminate any moisture in oven (one of the advantages of convection).
Porcelain chips	Oven racks removed and replaced incorrectly.	When oven racks are removed and replaced, always tilt racks upward and do not force them to avoid chipping the porcelain.



# TROUBLESHOOTING

ISSUE	POSSIBLE CAUSE	TROUBLESHOOTING
Oven door is locked and will not release, even after cooling.	Power may need to be reset.	Turn the oven off at the circuit breaker and wait a few seconds. Turn breaker back on. The oven should reset itself and will be operable.
Oven is not heating.	No power going to the oven.	Turn on power at the main power supply (fuse or circuit breaker box). If condition persists, call a qualified electrician.
	Oven Mode or Temperature not selected.	Press cooking option on keypad to select the oven mode and temperature.
Oven is not cooking evenly.	Oven rack is not in correct position.	Refer to the cook charts referenced on previous pages for recommended rack position.
	Convection Bake Mode	Always reduce recipe temperature by 25°F when baking with Convection Bake mode.
Oven light is not working properly.	Light bulb is loose or burned out.	Turn the oven off at the circuit breaker and wait a few seconds. Turn breaker back on. The oven should reset itself and will be operable.

# TROUBLESHOOTING

ISSUE	POSSIBLE CAUSE	TROUBLESHOOTING
Oven light stays on.	Oven door does not close completely.	Check for obstruction in oven door. Check to see if hinge is bent or door switch is broken.
Cannot remove lens cover on light.	Lens cover is dirty.	There may be a soil build-up around the lens cover. Wipe lens cover area with a clean dry towel prior to attempting to remove the lens cover.
Oven will not Self Clean properly.	Oven was still warm when Self Clean mode was selected.	Allow the oven to cool before running Self Clean.
	Oven is heavily soiled.	Always wipe out loose soils or heavy spillover before running Self Clean. See Oven Finishes/Cleaning Method section on page 36.
		If oven is badly soiled, set oven for a 4-hour Self Clean.
Clock and timer are not working properly.	No power going to the oven.	Turn the oven off at the circuit breaker and wait a few seconds. Turn breaker back on. The oven should reset itself and will be operable.
	Clock or Timer not set correctly.	See the Timer section on page 6 and the Clock section on page 9.

# TROUBLESHOOTING

ISSUE	POSSIBLE CAUSE	TROUBLESHOOTING
F03 or F04 Error appears in the display window.	A problem with latch mechanism occurred.	Turn off power at the main power supply (fuse or breaker box), wait a few seconds and turn it back on again. The oven should run a latch auto-test. If condition persists, note the code number and call ZLINE at 1-614-777-5004.
Other F_ Error appears in the display window.	Power may need to be reset.	Turn off power at the main power supply (fuse or breaker box), wait a few seconds and turn it back on again. If condition persists, note the code number and call ZLINE at 1-614-777-5004.
The oven display does not illuminate.	Power may need to be reset.	Turn off power at the main power supply (fuse or breaker box). Turn breaker back on. If condition persists, call ZLINE at 1-614-777-5004.
Cooling fan continues to run after oven is turned off.	The oven components have not cooled sufficiently.	The fan turns off automatically when the electronic components have cooled sufficiently.

# WARRANTY

## COVERAGE

ZLINE Kitchen and Bath wall oven products will be warrantied for one year from the original purchase date for the original purchaser of the product. This warranty covers all parts for necessary repairs if any part of the product proves to be defective in materials or workmanship.

## TERMS

This warranty applies only to the original purchaser of a range product installed for normal residential use. This is defined as a single-family, residential dwelling in a non-commercial setting. Commercial settings include but are not limited to: schools, churches, hotels, restaurants, vacation rentals such as Airbnb, day care centers, private clubs, fire stations, common areas in multi-family dwellings, nursing homes, food service locations, and institutional food service locations such as hospitals or correction facilities. This warranty is non-transferable and will not be extended based on the date of installation. The warranty applies only to products installed in the continental United States and the District of Columbia.

Warranty shall not apply and ZLINE Kitchen and Bath is not responsible for damage resulting from negligence, improper maintenance, misuse, abuse, alteration of or tampering with the appliance, accident, natural disaster, improper electric supply, flare-up fires, unauthorized service or repair, improper installation, or installation not in accordance with the instructions contained in the manual or local government codes.

## WHAT IS NOT COVERED

1. Installation or start-up, damages or problems caused by improper installation or use.
2. Service by an unauthorized service providers or damage related to unauthorized service or unauthorized parts.
3. Installation in any commercial or non-residential application.
4. Removal or re-installation cost.
5. Aesthetic damage, scratches, or natural wear caused by normal use.
6. Second-hand, open box products, or products purchased from an unauthorized retailer.

# WARRANTY



NOTE: Please write down the model number and serial number of your appliance. Both numbers are located on the rating label. Do not remove permanently affixed labels, warnings, or plates from the product. This will void the warranty. You may also consider attaching your receipt or proof of purchase to this manual.



## SERVICE

For warranty service, please contact our Customer Service team at 1-614-777-5004 or visit [www.zlinekitchen.com/contact](http://www.zlinekitchen.com/contact) to utilize our online Customer Experience Portal.



Need to purchase a part or accessory for your ZLINE product? Visit [www.zlineparts.com](http://www.zlineparts.com), ZLINE's official parts distribution partner.

2.2.1

[www.zlinekitchen.com](http://www.zlinekitchen.com)

1-614-777-5004

[contact@zlinekitchen.com](mailto:contact@zlinekitchen.com)

**ZLINE**  
ATTAINABLE LUXURY®