

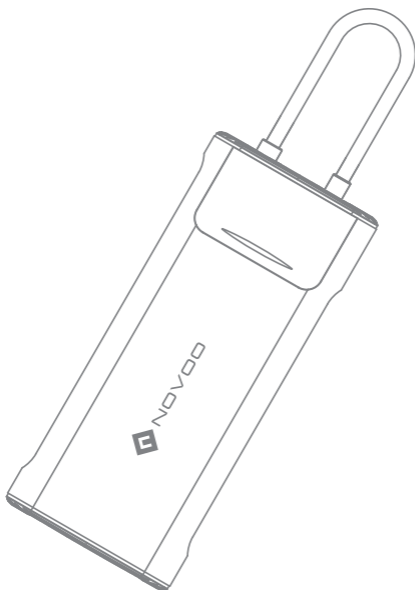

USER MANUAL



USB-C 12 in 1 Multiport Hub
Product Model: NVHUBSN12PLX



Made in China
Customer Support Team

Email: service@novoo-online.com

Instruction of product port

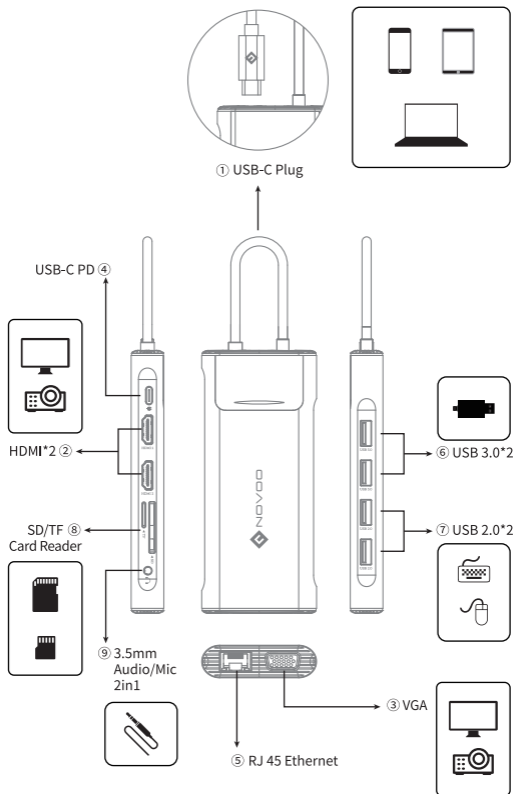

Specification

1. USB-C (Male)
2. HDMI*2: up to 4K*2K@30Hz (3840*2160@30Hz) resolution
3. VGA: up to 1920*1200@60Hz resolution
NOTE:
 - ① To use the HDMI and VGA ports, please ensure that the source port is Thunderbolt 3 or supports DP Alt Mode
 - ② The resolution will be 1080P while the HDMI and VGA are used at the same time
4. USB-C PD (Power Delivery) (Female): up to 100W (20V/5A), 6W~11W power consumption
5. USB 3.0*2: 5Gbps transmission speed. 5V, 1500mA total charging output
6. USB 2.0*2: 480Mbps transmission speed
7. RJ45: 10Mbps/100Mbps/1000Mbps
8. SD & TF Slots: depends on card's quality.
9. 3.5mm Audio/ Mic 2in1: Compliant with CTIA Standard, but Not supports USB HID for volume up, volume down, and mute while playback

Operating Temperature: 0~70°C

Operating Humidity: 10-90% RH

Storage Temperature: -10 to +70°C

Storage Humidity: 10% to 90% RH

Weight: 120±5g

Dimension: 133.2*58*16.5mm/ 5.24*2.28*0.65 inches

Certification: CE, UKCA, FCC, RoHS

Compatible with system: Windows, Mac OS, Android, Linux





Warranty: 12 months





Graphics Setting for HDMI Output Mode (macOS & Windows)

To achieve the 4K resolution, all the PC & external monitors & HDMI Cables must support 4K display output.

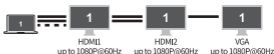
Mac OS

Note: Some options appear only when your Mac is connected to a display.
(Reference: Mac OS User Guide)



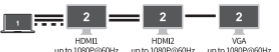







	How to set?	Sample Graph
Mirror Mode	Apple menu  > System Preferences > Displays > Arrangement > Tick Mirror Displays > Mirror Mode	 HDMI1/2 up to 4K@30Hz
		 VGA up to 1080P@60Hz
		 HDMI1/2 up to 1080P@60Hz VGA up to 1080P@60Hz
		 HDMI1 up to 4K@30Hz HDMI2 up to 4K@30Hz
		 HDMI1 up to 1080P@60Hz HDMI2 up to 1080P@60Hz VGA up to 1080P@60Hz

Extend Mode	Apple menu  > System Preferences > Displays > Arrangement > Extend Mode (Do not tick Mirror Displays)	
		
		
		
		

Windows

Since the DP Alt Mode built by Notebook USB C is basically 1.2 (DP 1.2), if you need to connect 3 extra monitors, one of the monitors (the computer screen or the 3 extra monitors) will turn off automatically. Only 3 monitors will work simultaneously.

For the DP 1.4 version or Thunderbolt 3 Notebook, if you need to connect 3 extra monitors, all the monitors (the computer screen and the 3 extra monitors) will work simultaneously, such as ASUS UXF3000E, Razer Rz09-0328, Lenovo TP00112A.

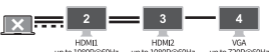
	How to set?	Sample Graph
Mirror Mode	Setting > System > Display > Multiple Display (Press Win  and P > Project > Duplicate)	
		
		
		
		
Extend Mode	Setting > System > Display > Multiple Display (Press Win  and P > Project > Extend)	
		
		
		
		

FAQ

Q1: Why there is no video output?

A1: Please make sure your USB-C source devices support video output (Support DP alt mode or Thunderbolt 3)

Please check the connection is well.

Please use High speed HDMI cable by Certified HDMI adopter

Q2: Why there is no audio output from HDMI port?

A2: Please make sure that there is audio output function on the monitor.

Please set the external monitor as default audio output device.

Q3: Sometimes WiFi stopped working while hard disk connected to hub, how to do?

A3: 2.4G network is easily disturbed. You can switch to 5G network, or you can adjust the placement of the hard disk, move to suitable place.

Q4: What to do if USB driver cannot be identified?

A4: Restart the computer and reconnect the product.

Q5: If display stopped after connect high current hard disk, how to do?

A5: Must be charged. Please supply by power adapter. Advice only connect one hard disk max.

Q6: When the computer is charged, the surface temperature of the product is high, it is normal?

A6: It is normal, but it is also in the range of the normal working temperature. After fully charged, the product will go back lower temperature.

Attention

- The current output of the new MacBook is around 1.5A. When the load exceeds 1.5A, the computer will start the self-protection function. Then prompt pop up(current overload), disable the prompt and restart your laptop. Connect the PD before plug in any other port.
- Please do not disconnect the PD when transferring data.
- Unplug the USB C hub, disable the i-Con, restart the laptop. Connect the wall charger (laptop' s charger) to the PD port then plug it into the laptop before using the other function.
- Connect the USB C Hub to the MacBook Pro/ Air via Type C PD port
- Connect the HDMI to the projector/TV/ display via HDMI cable (Use a 4K HDMI cable to achieve a 4K display)

FCC STATEMENT

This device complies with Part 15 of the FCC Rules. Operation is subject to the following two conditions:

This device may not cause harmful interference, and, (2) this device must accept any interference received, including interference that may cause undesired operation.

Spezifikationen

1. USB-C (männlich)
2. HDMI * 2: bis zu 4K * 2K bei 30 Hz (3840 * 2160 @ 30 Hz) Auflösung
3. VGA: bis zu 1920 * 1200 @ 60Hz Auflösung
HINWEIS:
 - ① Um die HDMI- und VGA-Anschlüsse zu verwenden, stellen Sie bitte sicher, dass der Quellanschluss Thunderbolt 3 ist oder den DP-Alt-Modus unterstützt
 - ② Die Auflösung beträgt 1080P, während HDMI und VGA gleichzeitig verwendet werden
4. USB-C PD (Stromversorgung) (weiblich): bis zu 100 W (20 V / 5 A), 6 W ~ 11 W Stromverbrauch
5. USB 3.0 * 2: 5 Gbit / s Übertragungsgeschwindigkeit. 5 V, 1500 mA Gesamtladeleistung
6. USB 2.0 * 2: 480 Mbit / s Übertragungsgeschwindigkeit
7. RJ45: 10 Mbit / s / 100 Mbit / s / 1000 Mbit / s
8. SD- und TF-Steckplätze: Abhängig von der Qualität der Karte.
9. 3,5-mm-Audio / Mikrofon 2in1: Entspricht dem CTIA-Standard, unterstützt jedoch nicht USB HID zum Erhöhen, Verringern und Stummschalten während der Wiedergabe

Betriebstemperatur: 0 ~ 70 ° C.

Betriebsfeuchtigkeit: 10-90% rF

Lagertemperatur: -10 bis + 70 ° C.

Lagerfeuchtigkeit: 10% bis 90% rF

Gewicht: 120 ± 5 g

Abmessung: 133,2 * 58 * 16,5 mm / 5,24 * 2,28 * 0,65 Zoll

Zertifizierung: CE, UKCA, FCC, RoHS

Kompatibel mit dem System: Windows, Mac OS, Android, Linux







Garantie: 12 Monate







Grafikeinstellung für den HDMI-Ausgabemodus (macOS & Windows)

Um die 4K-Auflösung zu erreichen, müssen alle PC- und externen Monitore sowie HDMI-Kabel die 4K-Displayausgabe unterstützen.

Mac OS

Hinweis: einige Optionen erscheinen nur, wenn dein Mac mit einem Monitor verbunden ist.
(Referenz: Mac OS Benutzerhandbuch)

	Wie einstellen?	Beispieldiagramm
Modus-Duplizierung	Apple  > Systemeinstellungen > Monitore > Anordnen > Wählen Sie Bildschirme synchronisieren	 HDMI1/2 bis zu 4K@30Hz
		 VGA bis zu 1080P@60Hz
		 HDMI1/2 bis zu 1080P@60Hz VGA bis zu 1080P@60Hz
		 HDMI1 bis zu 4K@30Hz HDMI2 bis zu 4K@30Hz
		 HDMI1 bis zu 1080P@60Hz HDMI2 bis zu 1080P@60Hz VGA bis zu 1080P@60Hz













Modus Erweitern	Apple  > Systemeinstellungen > Monitore > Anordnen > Wählen Sie keine Bildschirme synchronisieren	 <p>HDMI1/2 bis zu 4K@30Hz</p>
		 <p>VGA bis zu 1080P@60Hz</p>
		 <p>HDMI1/2 bis zu 1080P@60Hz VGA bis zu 1080P@60Hz</p>
		 <p>HDMI1 bis zu 4K@30Hz HDMI2 bis zu 4K@30Hz</p>
		 <p>HDMI1 bis zu 1080P@60Hz HDMI2 bis zu 1080P@60Hz VGA bis zu 1080P@60Hz</p>

Windows

Hinweis: Einige Optionen werden nur angezeigt, wenn Ihr PC an ein Display angeschlossen ist.

Da der von Notebook USB C erstellte DP-Alt-Modus grundsätzlich 1,2 (DP 1,2) beträgt, wird einer der Monitore (der Computerbildschirm oder die 3 zusätzlichen Monitore) automatisch ausgeschaltet, wenn Sie 3 zusätzliche Monitore anschließen müssen. Nur 3 Monitore arbeiten gleichzeitig.

Wenn Sie für die DP 1.4-Version oder das Thunderbolt 3-Notebook 3 zusätzliche Monitore anschließen müssen, funktionieren alle Monitore (der Computerbildschirm und die 3 zusätzlichen Monitore) gleichzeitig, z. B. ASUS UXF3000E, Razer Rz09-0328, Lenovo TP00112A.

	Wie einstellen?	Beispieldiagramm
Modus-Duplizierung	Einstellungen > System > Anzeige > Mehrere Bildschirme (Drücken Sie WIN  und P > PROJIZIEREN > DUPLIZIEREN)	 <p>HDMI1/2 bis zu 4K@30Hz</p>
		 <p>VGA bis zu 1080P@60Hz</p>
		 <p>HDMI1/2 bis zu 1080P@60Hz VGA bis zu 1080P@60Hz</p>
		 <p>HDMI1 bis zu 1080P@60Hz HDMI2 bis zu 1080P@60Hz</p>
		 <p>HDMI1 bis zu 1080P@60Hz HDMI2 bis zu 1080P@60Hz VGA bis zu 1080P@60Hz</p>
Modus Erweitern	Einstellungen > System > Anzeige > Mehrere Bildschirme (Drücken Sie WIN  und P > PROJIZIEREN > ERWEITERN)	 <p>HDMI1/2 bis zu 4K@30Hz</p>
		 <p>VGA bis zu 1080P@60Hz</p>
		 <p>HDMI1/2 bis zu 1080P@60Hz VGA bis zu 1080P@60Hz</p>
		 <p>HDMI1 bis zu 1080P@60Hz HDMI2 bis zu 1080P@60Hz</p>
		 <p>HDMI1 bis zu 1080P@60Hz HDMI2 bis zu 1080P@60Hz VGA bis zu 720P@60Hz</p>

FAQ

Q1: Warum gibt es keine Videoausgabe?

A1: Stellen Sie sicher, dass Ihre USB-C-Quellgeräte die Videoausgabe unterstützen (Unterstützung des DP-Alt-Modus oder Thunderbolt 3).

Bitte überprüfen Sie, ob die Verbindung gut ist.

Bitte verwenden Sie ein Hochgeschwindigkeits-HDMI-Kabel von einem zertifizierten HDMI-Anwender

Q2: Warum gibt es keinen Audioausgang vom HDMI-Anschluss?

A2: Bitte stellen Sie sicher, dass auf dem Monitor eine Audioausgabefunktion vorhanden ist.

Bitte stellen Sie den externen Monitor als Standard-Audioausgabegerät ein.

Q3: Manchmal funktionierte WiFi nicht mehr, während die Festplatte mit dem Hub verbunden war. Wie geht das?

A3: 2.4G-Netzwerk kann leicht gestört werden. Sie können zum 5G-Netzwerk wechseln oder die Position der Festplatte anpassen und an einen geeigneten Ort verschieben.

Q4: Was tun, wenn der USB-Treiber nicht identifiziert werden kann?

A4: Starten Sie den Computer neu und schließen Sie das Produkt wieder an.

Q5: Wie gehen Sie vor, wenn die Anzeige nach dem Anschließen der Hochstromfestplatte angehalten wird?

A5: Muss aufgeladen werden. Bitte per Netzteil liefern. Hinweis nur eine Festplatte anschließen max.

Q6: Wenn der Computer aufgeladen ist, ist die Oberflächentemperatur des Produkts hoch, ist es normal?

A6: Es ist normal, liegt aber auch im Bereich der normalen Arbeitstemperatur. Nach dem vollständigen Aufladen hat das Produkt wieder eine niedrigere Temperatur.

Beachtung

- Die aktuelle Leistung des neuen MacBook beträgt ca. 1,5 A. Wenn die Last 1,5 A überschreitet, startet der Computer die Selbstschutzfunktion. Öffnen Sie dann die Eingabeaufforderung (aktuelle Überlastung), deaktivieren Sie die Eingabeaufforderung und starten Sie Ihren Laptop neu. Schließen Sie die PD an, bevor Sie einen anderen Port anschließen.
- Bitte trennen Sie die PD nicht, wenn Sie Daten übertragen.
- Trennen Sie den USB C-Hub vom Computer, deaktivieren Sie die i-Con und starten Sie den Laptop neu. Schließen Sie das Wandladegerät (das Ladegerät des Laptops) an den PD-Anschluss an und schließen Sie es an den Laptop an, bevor Sie die andere Funktion verwenden.
- Verbinden Sie den USB C Hub über den Typ C PD-Anschluss mit dem MacBook Pro / Air
- Verbinden Sie das HDMI über ein HDMI-Kabel mit dem Projektor / Fernseher / Display (Verwenden Sie ein 4K-HDMI-Kabel, um ein 4K-Display zu erhalten).

FCC ERKLÄRUNG

Dieses Gerät entspricht Teil 15 der FCC-Bestimmungen. Der Betrieb unterliegt den folgenden zwei Bedingungen:

Dieses Gerät darf keine schädlichen Störungen verursachen. (2) Dieses Gerät muss alle empfangenen Störungen akzeptieren, einschließlich Störungen, die einen unerwünschten Betrieb verursachen können.



Spécification

1. USB-C (Mâle)
2. HDMI*2: jusqu' à la résolution de 4K*2K@30Hz (3840*2160@30Hz)
3. VGA: jusqu' à la résolution de 1920*1200@60Hz
REMARQUE:
 - ① Pour utiliser le HDMI et le VGA, veuillez vous assurer que le port Type-C de votre appareil source est de Thunderbolt 3 ou supporte le mode DP Alt
 - ② La résolution sera de 1080P tandis que HDMI et VGA sont utilisés en même temps
4. USB-C PD (Power Delivery) (Femelle): jusqu' à 100W (20V/5A), 6W~11W consommation d'énergie
5. USB 3.0*2: vitesse de transmission jusqu'à 5Gbps; Sortie de charge totale 5V, 1500mA
6. USB 2.0*2: vitesse de transmission jusqu'à 480Mbps
7. RJ45: 10Mbps/100Mbps/1000Mbps
8. Fentes SD & TF: dépendre de la qualité de la carte SD et TF
9. 3.5mm Audio/ Mic 2en1: Conforme à la norme CTIA, mais ne supporte pas USB HID pour augmenter le volume, réduire le volume et couper le son pendant la lecture

Température de Fonctionnement: 0 °C ~ 70 °C

Humidité de Fonctionnement: 10% ~ 90% HR

Température de Stockage: -10 °C ~ + 70 °C

Humidité de Stockage: 10% ~ 90% HR

Poids: 120±5g

Dimension: 133,2*58*16,5mm/ 5,24*2,28*0,65 pouces

Certification: CE, UKCA, FCC, RoHS

Système Compatible: Windows, Mac OS, Android, Linux







Garantie: 12 mois







Paramètres Graphiques pour le Mode de Sortie HDMI (Mac et Windows)

Pour atteindre la résolution 4K, le PC & les moniteurs externes & le câble de HDMI doivent supporter 4K.

Mac OS

Remarque: Certaines options ne s'affichent que lorsque votre Mac est connecté à un moniteur.
(Référence: Guide de l'utilisateur de MacOS)

	Comment Régler ?	Exemple de Graphique
Mode de Duplication	Le menu d' Apple  > Préférence Système > Moniteurs > Disposition > Cocher 'Recopie vidéo'	 HDMI1/2 jusqu' à 4K@30Hz
		 VGA jusqu' à 1080P@60Hz
		 HDMI1/2 jusqu' à 1080P@60Hz VGA jusqu' à 1080P@60Hz
		 HDMI1 jusqu' à 4K@30Hz HDMI2 jusqu' à 4K@30Hz
		 HDMI1 jusqu' à 1080P@60Hz HDMI2 jusqu' à 1080P@60Hz VGA jusqu' à 1080P@60Hz









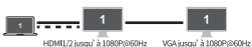

Mode de Extension	Le menu d'Apple  > Préférence Système > Moniteurs > Disposition > Ne pas cocher 'Recopie vidéo'	
		
		
		
		

Windows

Remarque: Certaines options ne s'affichent que lorsque votre ordinateur portable est connecté à un écran.

Étant donné que le mode DP Alt construit par l'ordinateur portable USB C est fondamentalement 1.2 (DP 1.2), si vous devez connecter 3 moniteurs supplémentaires, l'un des moniteurs (l'écran de l'ordinateur ou les 3 moniteurs supplémentaires) s'éteindra automatiquement. Seuls 3 moniteurs fonctionneront simultanément.

Pour l'ordinateur portable de la version DP 1.4 ou Thunderbolt 3, si vous devez connecter 3 moniteurs supplémentaires, tous les moniteurs (l'écran de l'ordinateur et les 3 moniteurs supplémentaires) fonctionneront simultanément, tels que ASUS UXF3000E, Razer Rz09-0328, Lenovo TP00112A.

	Comment Régler ?	Exemple de Graphique
Mode de Duplication	Paramètre > Système > Affichage > Écrans multiples (Appuyer sur Win  et P > PROJECTER > Dupliquer)	
		
		
		
		
Mode de Extension	Paramètre > Système > Affichage > Écrans multiples (Appuyer sur Win  et P > PROJECTER > Étendre)	
		
		
		
		

FAQ

Q1: Pourquoi il n'y a pas de sortie vidéo?

A1: Veuillez vous assurer que vos périphériques sources USB-C supportent la sortie vidéo (supporter le mode DP alt ou Thunderbolt 3)

Veuillez vérifier que la connexion est correcte.

Veuillez utiliser un câble HDMI de haute vitesse par un adoptant HDMI certifié

Q2: Pourquoi il n'y a pas de sortie audio du port HDMI?

A2: Veuillez vous assurer qu'il existe une fonction de sortie audio sur le moniteur.

Veuillez définir le moniteur externe comme périphérique de sortie audio par défaut.

Q3: Parfois, le WiFi a cessé de fonctionner lorsque le disque dur est connecté au hub, comment faire?

A3: Le réseau 2.4G est facilement perturbé. Vous pouvez régler au réseau 5G, ou vous pouvez ajuster le placement du disque dur, vous déplacer vers un endroit approprié.

Q4: Que faire si le appareil USB ne peut pas être identifié?

A4: Redémarrez l'ordinateur et reconnectez le produit.

Q5: Si l'affichage s'est arrêté après avoir connecté un disque dur à courant élevé, comment faire?

A5: Doit être alimenté. Veuillez connecter un adaptateur secteur pour recharger l'ordinateur portable. Conseil ne connectez qu'un seul disque dur max.

Q6: Lorsque l'ordinateur portable est chargé, la température de surface du produit est élevée, est-ce normal?

A6: C'est normal, mais c'est également dans la plage de la température de fonctionnement normale. Une fois complètement chargé, le produit reviendra à une température plus basse.

Attention

- La sortie de courant du nouveau Macbook est d'environ 1,5 A. Lorsque la charge dépasse 1,5 A, l'ordinateur démarre la fonction d'autoprotection. Ensuite, l'invite apparaît (surcharge de courant), désactivez l'invite et redémarrez votre ordinateur portable. Connectez le PD avant de brancher un autre port.
- Veuillez ne pas déconnecter le PD lors du transfert de données.
- Débranchez le hub USB C, désactivez l'iCon, redémarrez l'ordinateur portable. Connectez le chargeur mural (chargeur de l'ordinateur portable) au port PD, puis branchez-le sur l'ordinateur portable avant d'utiliser l'autre fonction.
- Connectez le hub USB C au MacBook Pro / Air via le port PD de type C
- Connectez le HDMI au projecteur / téléviseur / écran via un câble HDMI (utilisez un câble HDMI 4K pour obtenir un affichage 4K)

DÉCLARATION FCC

Cet appareil est conforme à la partie 15 des règles FCC. Son fonctionnement est soumis aux deux conditions suivantes:

Cet appareil ne doit pas provoquer d'interférences nuisibles, et. (2) cet appareil doit accepter toute interférence reçue, y compris les interférences pouvant entraîner un fonctionnement indésirable.

Especificación

1. USB-C (Enchufe)
2. HDMI*2: resolución de hasta 4K * 2K @ 30Hz (3840 * 2160 @ 30Hz)
3. VGA: resolución de hasta 1920 * 1200 @ 60Hz
NOTA:
 - ① Para usar los puertos HDMI y VGA, asegúrese de que el puerto de origen sea Thunderbolt 3 o sea compatible con el modo DP Alt
 - ② La resolución será 1080P mientras que HDMI y VGA se utilizan al mismo tiempo
4. USB-C PD (La entrega de energía) (Ranuras): hasta 100 W (20 V / 5 A), 6 W ~ 11 W de consumo de energía
5. USB 3.0*2: Velocidad de transmisión de 5 Gbps. Salida de carga total de 5 V, 1500 mA
6. USB 2.0*2: Velocidad de transmisión de 480 Mbps
7. RJ45: 10Mbps/100Mbps/1000Mbps
8. Ranuras SD y TF: depende de la calidad de la tarjeta.
9. Audio / micrófono de 3,5 mm 2 en 1: compatible con el estándar CTIA, pero no es compatible con USB HID para subir y bajar el volumen y silenciar durante la reproducción

Temperatura de funcionamiento: 0°C~70°C

Humedad de funcionamiento: 10%~90% RH

Temperatura de almacenamiento: -10°C~ +70°C

Humedad de almacenamiento: 10%~90% RH

Peso: 120±5g

Dimensión: 133.2*58*16.5mm/ 5.24*2.28*0.65 pulgadas

Certificación: CE, UKCA, FCC, RoHS

Sistema compatible: Windows, Mac OS, Android, Linux







Garantía: 12 months







Configuración de gráficos para el modo de salida HDMI (macOS y Windows)

Para lograr la resolución 4K, todos los monitores externos y de PC y los cables HDMI deben admitir la salida de pantalla 4K.

Mac OS

Nota: Algunas opciones aparecen únicamente cuando el Mac está conectado a una pantalla.
(Referencia: Manual del usuario de macOS)

	¿Cómo establecer?	Gráfico de muestra
Modo de duplicación	Apple menu  > Preferencias del Sistema > Pantallas > Alineación > garrapata Pantallas duplicadas > Modo Espejo	 HDMI1/2 hasta 4K@30Hz
		 VGA hasta 1080P@60Hz
		 HDMI1/2 hasta 1080P@60Hz VGA hasta 1080P@60Hz
		 HDMI1 hasta 4K@30Hz HDMI2 hasta 4K@30Hz
		 HDMI1 hasta 1080P@60Hz HDMI2 hasta 1080P@60Hz VGA hasta 1080P@60Hz











Modo de extensión	Apple menu  > Preferencias del Sistema > Pantallas > Alineación > Modo Extendido (No marcar Pantallas duplicadas)	 HDM1/2 hasta 4K@30Hz
		 VGA hasta 1080P@60Hz
		 HDM1/2 hasta 1080P@60Hz VGA hasta 1080P@60Hz
		 HDM1 hasta 4K@30Hz HDM2 hasta 4K@30Hz
		 HDM1 hasta 1080P@60Hz HDM2 hasta 1080P@60Hz VGA hasta 1080P@60Hz

Windows

Nota: Algunas opciones aparecen únicamente cuando el PC está conectado a una pantalla.

Dado que el modo DP Alt creado por Notebook USB C es básicamente 1.2 (DP 1.2), si necesita conectar 3 monitores adicionales, uno de los monitores (la pantalla de la computadora o los 3 monitores adicionales) se apagará automáticamente. Solo 3 monitores funcionarán simultáneamente.

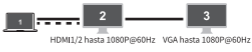
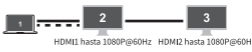
Para la versión DP 1.4 o Thunderbolt 3 Notebook, si necesita conectar 3 monitores adicionales, todos los monitores (la pantalla de la computadora y los 3 monitores adicionales) funcionarán simultáneamente, como ASUS UXF3000E, Razer Rz09-0328, Lenovo TP00112A.

	¿Cómo establecer?	Gráfico de muestra
Modo de duplicación	Configuración > Sistema > Pantalla > Varias pantallas (Prensa Win  and P > PROYECTARR > Duplicado)	 HDM1/2 hasta 4K@30Hz
		 VGA hasta 1080P@60Hz
		 HDM1/2 hasta 1080P@60Hz VGA hasta 1080P@60Hz
		 HDM1 hasta 1080P@60Hz HDM2 hasta 1080P@60Hz
		 HDM1 hasta 1080P@60Hz HDM2 hasta 1080P@60Hz VGA hasta 1080P@60Hz
Modo de extensión	Configuración > Sistema > Pantalla > Varias pantallas (Prensa Win  and P > PROYECTARR > Ampliar)	 HDM1/2 hasta 4K@30Hz
		 VGA hasta 1080P@60Hz
		 HDM1/2 hasta 1080P@60Hz VGA hasta 1080P@60Hz
		 HDM1 hasta 1080P@60Hz HDM2 hasta 1080P@60Hz
		 HDM1 hasta 1080P@60Hz HDM2 hasta 1080P@60Hz VGA hasta 720P@60Hz

PREGUNTAS MÁS FRECUENTES

Q1: ¿Por qué no hay salida de video?

A1: Asegúrese de que sus dispositivos de fuente USB-C sean compatibles con la salida de video (compatible con el modo alternativo DP o Thunderbolt 3)

Compruebe que la conexión esté bien.

Utilice un cable HDMI de alta velocidad de un adoptador HDMI certificado

Q2: ¿Por qué no hay salida de audio desde el puerto HDMI?

A2: Asegúrese de que haya una función de salida de audio en el monitor.

Configure el monitor externo como dispositivo de salida de audio predeterminado.

Q3: A veces, WiFi deja de funcionar mientras el disco duro está conectado al concentrador, ¿cómo se hace?

A3: La red 2.4G se perturba fácilmente. Puede cambiar a la red 5G, o puede ajustar la ubicación del disco duro, muévelo al lugar adecuado.

Q4: ¿Qué hacer si no se puede identificar el controlador USB?

A4: Reinicie la computadora y vuelva a conectar el producto.

Q5: Si la pantalla se detuvo después de conectar el disco duro de alta corriente, ¿cómo hacerlo?

A5: Debe cargarse. Suministre con adaptador de corriente. Consejo sólo conecte un disco duro máx.

Q6: Cuando la computadora está cargada, la temperatura de la superficie del producto es alta, ¿es normal?

A6: Es normal, pero también está en el rango de la temperatura normal de trabajo. Una vez cargado por completo, el producto volverá a bajar la temperatura.

Atención

- La salida actual del nuevo MacBook es de alrededor de 1,5 A. Cuando la carga supera los 1,5 A, la computadora iniciará la función de autoprotección. Luego, aparecerá el mensaje emergente (sobrecarga actual), deshabilite el mensaje y reinicie su computadora portátil. Conecte el PD antes de enchufar cualquier otro puerto.
- No desconecte el PD cuando transfiera datos.
- Desenchufe el concentrador USB C, desactive el i-Con, reinicie la computadora portátil. Conecte el cargador de pared (cargador de la computadora portátil) al puerto PD y luego conéctelo a la computadora portátil antes de usar la otra función.
- Conecte el concentrador USB C al MacBook Pro / Air a través del puerto PD tipo C.
- CConecte el HDMI al proyector / TV / pantalla mediante un cable HDMI (use un cable HDMI 4K para lograr una pantalla 4K).

DECLARACIÓN DE LA FCC

Este dispositivo cumple con la Parte 15 de las Reglas de la FCC. El funcionamiento está sujeto a las dos condiciones siguientes:

Este dispositivo no puede causar interferencias perjudiciales y (2) este dispositivo debe aceptar cualquier interferencia recibida, incluida la interferencia que pueda causar un funcionamiento no deseado.

Specifica

1. USB-C (maschio)
2. HDMI * 2: risoluzione fino a 4K * 2K a 30 Hz (3840 * 2160 a 30 Hz)
3. VGA: risoluzione fino a 1920 * 1200 a 60 Hz
NOTA:
 - ① Per utilizzare le porte HDMI e VGA, assicurati che la porta sorgente sia Thunderbolt 3 o supporti la modalità DP Alt
 - ② La risoluzione sarà 1080P mentre HDMI e VGA vengono utilizzati contemporaneamente
4. USB-C PD (Power Delivery) (femmina): fino a 100 W (20 V / 5 A), 6 W ~ 11 W di consumo energetico
5. USB 3.0 * 2: velocità di trasmissione 5 Gbps. Uscita di carica totale da 5 V, 1500 mA
6. USB 2.0 * 2: velocità di trasmissione 480 Mbps
7. RJ45: 10 Mbps / 100 Mbps / 1000 Mbps
8. Slot SD e TF: dipende dalla qualità della scheda.
9. Audio / microfono da 3,5 mm 2in1: conforme allo standard CTIA, ma non supporta USB HID per aumentare, diminuire il volume e disattivare l'audio durante la riproduzione

Temperatura di funzionamento: 0 ~ 70 ° C

Umidità operativa: 10-90% di umidità relativa

Temperatura di stoccaggio: da -10 a + 70 ° C

Umidità di stoccaggio: dal 10% al 90% di umidità relativa

Peso: 120 ± 5 g

Dimensione: 133,2 * 58 * 16,5 mm / 5,24 * 2,28 * 0,65 pollici

Certificazione: CE, UKCA, FCC, RoHS

Compatibile con il sistema: Windows, Mac OS, Android, Linux







Garanzia: 12 mesi

Impostazione grafica per la modalità di uscita HDMI (macOS e Windows)



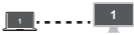

Per ottenere la risoluzione 4K, tutti i PC, i monitor esterni e i cavi HDMI devono supportare l'uscita del display 4K.

Mac OS

Nota: Alcune opzioni vengono infatti visualizzate solo quando il Mac è collegato a uno schermo.
(Riferimento: Manuale utente di MacOS) (Reference: Mac OS User Guide)

	Come impostare?	Grafico di esempio
Modalità Duplicata	Menu Apple  > Preferenze di Sistema > Monitor > Disposizione > Spuntare "Duplica monitor"	 HDMI1/2 fino a 4K@30Hz
		 VGA fino a 1080P@60Hz
		 HDMI1/2 fino a 1080P@60Hz VGA fino a 1080P@60Hz
		 HDMI1 fino a 4K@30Hz HDMI2 fino a 4K@30Hz
		 HDMI1 fino a 1080P@60Hz HDMI2 fino a 1080P@60Hz VGA fino a 1080P@60Hz



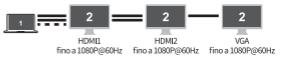









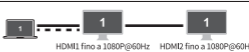

Modalità estesa	Menu Apple  > Preferenze di Sistema > Monitor > Disposizione > Non spuntare 'Duplica monitor'	
		
		
		
		

Windows

Nota: alcune opzioni vengono visualizzate solo quando il PC è collegato a uno schermo.

Poiché la DP Alt Mode costruita da Notebook USB C è fondamentalmente 1.2 (DP 1.2), se è necessario collegare 3 monitor aggiuntivi, uno dei monitor (lo schermo del computer o i 3 monitor aggiuntivi) si spegnerà automaticamente. Solo 3 monitor funzioneranno contemporaneamente.

Per la versione DP 1.4 o il notebook Thunderbolt 3, se è necessario collegare 3 monitor aggiuntivi, tutti i monitor (lo schermo del computer e i 3 monitor aggiuntivi) funzioneranno contemporaneamente, come ASUS UXF3000E, Razer Rz09-0328, Lenovo TP00112A.

	Come impostare?	Grafico di esempio
Modalità Duplicata	Impostazioni > Sistema > Schermo > Più schermi (Premi Win  e P > Proietta > Duplica)	
		
		
		
		
Modalità estesa	Impostazioni > Sistema > Schermo > Più schermi (Premi Win  e P > Proietta > Estendi)	
		
		
		
		

FAQ

Q1: Perché non c'è uscita video?

A1: Assicurati che i tuoi dispositivi sorgente USB-C supportino l'uscita video (Supporta la modalità DP alt o Thunderbolt 3)

Si prega di verificare che la connessione sia corretta.

Utilizzare un cavo HDMI ad alta velocità di un utente HDMI certificato

Q2: Perché non c'è uscita audio dalla porta HDMI?

A2: Assicurati che sul monitor sia presente la funzione di uscita audio.

Si prega di impostare il monitor esterno come dispositivo di uscita audio predefinito.

Q3: A volte il WiFi smette di funzionare mentre il disco rigido è connesso all'hub, come fare?

A3: La rete 2.4G è facilmente disturbata. È possibile passare alla rete 5G o regolare la posizione del disco rigido, spostarsi in un luogo adatto.

Q4: Cosa fare se non è possibile identificare il driver USB?

A4: riavviare il computer e ricollegare il prodotto.

Q5: Se il display si interrompe dopo aver collegato il disco rigido ad alta corrente, come fare?

A5: deve essere addebitato. Si prega di fornire tramite adattatore di alimentazione.

Consiglio collegare solo un disco rigido max.

Q6: Quando il computer è carico, la temperatura superficiale del prodotto è elevata, è normale?

A6: È normale, ma rientra anche nell'intervallo della normale temperatura di lavoro.

Dopo la ricarica completa, il prodotto tornerà a una temperatura inferiore.

Attenzione

- La corrente in uscita del nuovo MacBook è di circa 1,5 A. Quando il carico supera 1,5 A, il computer avvierà la funzione di autoprotezione. Quindi prompt pop-up (sovraccarico corrente), disabilitare il prompt e riavviare il laptop. Collegare il PD prima di collegare qualsiasi altra porta.
- Si prega di non scollegare il PD durante il trasferimento dei dati.
- Scollegare l'hub USB C, disabilitare l'i-Con, riavviare il laptop. Collegare il caricatore a muro (caricatore del laptop) alla porta PD, quindi collegarlo al laptop prima di utilizzare l'altra funzione.
- Collega l'hub USB C a MacBook Pro / Air tramite la porta PD di tipo C.
- Collegare l'HDMI al proiettore / TV / display tramite cavo HDMI (utilizzare un cavo HDMI 4K per ottenere un display 4K)

DICHIARAZIONE FCC

Questo dispositivo è conforme alla Parte 15 delle norme FCC. Il funzionamento è soggetto alle seguenti due condizioni:

Questo dispositivo non può causare interferenze dannose e (2) questo dispositivo deve accettare qualsiasi interferenza ricevuta, incluse le interferenze che potrebbero causare un funzionamento indesiderato.



仕様

1. USB-C プラグ)
2. HDMI*2: 最大4K*2K@30Hz (3840*2160@30Hz) の解像度
3. VGA: 最大 1920*1200@60Hz の解像度
注意:
 - ① HDMIおよびVGAポートを使用するには、ソースポートがThunderbolt 3であるか、DP Alt モードをサポートしていることを確認してください。
 - ② 最大1920 * 1200 @ 60Hzの解像度
4. USB-C PD (電力供給) (ソケット): 最大100W (20V/5A), 6W~11W の消費電力
5. USB 3.0*2: 最大5Gbpsの伝送速度。5V、1500mAの合計充電出力
6. USB 2.0*2: 480Mbpsの伝送速度
7. RJ45: 10Mbps/100Mbps/1000Mbps
8. SD & TF Slots: SDおよびTFカードの品質によって異なります。
9. 3.5mm オーディオ/ マイク 2in1: 規格に準拠していますが、再生中のボリュームアップ、ボリュームダウン、ミュートのためのUSB HIDはサポートしていません。

動作温度: 0~70°C

動作湿度: 10-90% RH

保管温度: -10 to +70°C

保管湿度: 10% to 90% RH

重量: 120±5g

寸法: 133.2*58*16.5mm/ 5.24*2.28*0.65インチ

認証: CE, UKCA, FCC, RoHS

互換性のあるシステム: Windows, Mac OS, Android, Linux

保証: 12ヶ月







HDMI出力モードのグラフィックス設定 (macOSおよびWindows)







4K解像度を実現するには、すべてのPC、外付けモニター、HDMIケーブルが4Kディスプレイ出力をサポートしている必要があります。

Mac OS

注意:一部のオプションは、Macがディスプレイに接続されている場合にのみ表示されます。

(参照:Mac OSユーザーガイド)

	設定方法	サンプルグラフ
ミラー モード	Apple メニュー  > システム環境設定 > ディスプレイ > 配置 > ディスプレイをミラーリングすることはチェックしてください > ミラーモード	 最大4K @ 30HzのHDMI1/2
		 最大1080P @ 60HzのVGA
		 最大1080P @ 60HzのHDMI1/2 最大1080P @ 60HzのVGA
		 最大4K @ 30HzのHDMI1/2 最大4K @ 30HzのHDMI1/2
		 最大1080P @ 60Hz のHDMI1 最大1080P @ 60Hz のHDMI2 最大1080P @ 60Hz のVGA













拡張 モード	Appleメニュー  > システム環境設定 > ディスプレイ > 配置 > 拡張モード (ディスプレイをミラーリングすることはチェックしないでください)	 最大4K @ 30HzのHDMI1/2
		 最大1080P @ 60HzのVGA
		 最大1080P @ 60HzのHDMI1/2 最大1080P @ 60HzのVGA
		 最大4K @ 30HzのHDMI1/2 最大4K @ 30HzのHDMI1/2
		 最大1080P @ 60HzのHDMI1 最大1080P @ 60HzのHDMI2 最大1080P @ 60HzのVGA

Windows

注意: 一部のオプションは、PCがディスプレイに接続されている場合にのみ表示されます。

ノートパソコンのUSB Cに内蔵されているDP Altモードは基本的に1.2 (DP 1.2)なので、3台のモニタを追加接続する必要がある場合、1つのモニタ(コンピュータ画面または3台の追加モニタ)が自動的に閉じ、3台のモニタだけが同時に動作します。

DP 1.4バージョンまたはThunderbolt 3ノートパソコンでは、3台の追加モニタを接続する必要がある場合、すべてのモニタ(コンピュータ画面と3台の追加モニタ)が同時に動作します。例えば: ASUS UXF 3000 E、Razer Rz 09-0328、Lenovo TP 00112 Aなどです。

	設定方法	サンプルグラフ
複製 モード	設定 > システム > ディスプレイ > マルチディスプレイ (またはキーボードでWin  とPを押します > 映す > 複製)	 最大4K @ 30HzのHDMI1/2
		 最大1080P @ 60HzのVGA
		 最大1080P @ 60HzのHDMI1/2 最大1080P @ 60HzのVGA
		 最大1080P @ 60HzのHDMI1 最大1080P @ 60HzのHDMI2
		 最大1080P @ 60HzのHDMI1 最大1080P @ 60HzのHDMI2 最大1080P @ 60HzのVGA
拡張 モード	設定 > システム > ディスプレイ > マルチディスプレイ (またはキーボードでWin  とPを押します > 映す > 拡張)	 最大4K @ 30HzのHDMI1/2
		 最大1080P @ 60HzのVGA
		 最大1080P @ 60HzのHDMI1/2 最大1080P @ 60HzのVGA
		 最大1080P @ 60HzのHDMI1 最大1080P @ 60HzのHDMI2
		 最大1080P @ 60HzのHDMI1 最大1080P @ 60HzのHDMI2 最大720P @ 60HzのVGA

よくある質問

Q1: ビデオ出力がないのはなぜですか？

A1: USB-Cソースデバイスがビデオ出力をサポートしていることを確認してください。(DP alt モードまたはThunderbolt3をサポート)

接続が良好であることを確認してください。

認定HDMIアダプターによる高速HDMIケーブルをご利用ください。

Q2: HDMIポートからの音声出力がないのはなぜですか？

A2: モニターに音声出力機能があることを確認してください。

外部モニターをデフォルトのオーディオ出力デバイスとして設定してください。

Q3: ハードディスクがハブに接続されているときにWiFiが機能しなくなることがありますが、どうすればよいですか？

A3: 2.4Gネットワークは簡単に妨害されます。5Gネットワークに切り替えるか、ハードディスクの配置を調整して、適切な場所に移動することができます。

Q4: USBドライバが識別できない場合はどうすればよいですか？

A4: コンピューターを再起動し、製品を再接続します。

Q5: 大電流ハードディスクを接続した後、表示が止まった場合はどうすればよいですか？

A5: 充電する必要があります。電源アダプタで供給してください。アドバイスは、最大1台のハードディスクのみを接続します。

Q6: コンピュータを充電すると、製品の表面温度が高くなりますが、正常ですか？

A6: 正常ですが、正常動作温度の範囲内です。完全に充電されると、製品はより低い温度に戻ります。

注意

- 新しいMacbookの現在の出力は約1.5Aです。負荷が1.5Aを超えると、コンピュータは自己保護機能を開始します。次に、プロンプトポップアップ(現在の過負荷)、プロンプトを無効にして、ラップトップを再起動します。他のポートに接続する前にPDを接続してください。
- データを転送するときは、PDを切断しないでください。
- USB-Cハブのプラグを抜いて、iConを無効にし、ラップトップを再起動します。壁面充電器(ノートパソコンの充電器)をPDポートに接続し、ノートパソコンに接続してから他の機能を使用してください。
- タイプCのPDポートを介してUSB-CハブをMacBookPro / Airに接続します。
- HDMIケーブルを介してHDMIをプロジェクター/ TV /ディスプレイに接続します。(4K HDMIケーブルを使用して4Kディスプレイを実現します。)

FCC規定

このデバイスはFCC規則第15部に準拠しています。操作には次の2つの条件があります。(1)このデバイスは、有害な干渉を引き起こさない可能性があります。(2)このデバイスは、望ましくない動作を引き起こす可能性のある干渉を含め、受信した干渉を受け入れる必要があります。

