

# ERGO

enhanced room geometry optimization



## USER MANUAL



## IMPORTANT SAFETY INSTRUCTIONS



**CAUTION:** THE LIGHTNING FLASH WITH AN ARROWHEAD SYMBOL WITHIN AN EQUILATERAL TRIANGLE IS INTENDED TO ALERT THE USER TO THE PRESENCE OF UN-INSULATED DANGEROUS VOLTAGE WITHIN THE UNITS ENCLOSURE THAT MAY BE OF SUFFICIENT MAGNITUDE TO CONSTITUTE A RISK OF ELECTRIC SHOCK TO PERSONS.



**WARNING:** THE EXCLAMATION POINT WITHIN AN EQUILATERAL TRIANGLE IS INTENDED TO ALERT THE USER TO THE PRESENCE OF IMPORTANT OPERATING AND MAINTENANCE (SERVICING) INSTRUCTIONS IN THE LITERATURE ACCOMPANYING THE PRODUCT.



**NOTE:** THE HAND WITHIN AN EQUILATERAL TRIANGLE IS INTENDED TO ALERT THE USER TO SPECIFIC GUIDANCE AND INFORMATION REGARDING THE OPERATION OF THE UNIT, AND SHOULD BE READ FULLY BEFORE USING THE UNIT FOR THE FIRST TIME.



**CAUTION:** TO REDUCE THE RISKS OF FIRE OR ELECTRIC SHOCK DO NOT REMOVE ANY COVERS, OR OPEN THE UNIT. THERE ARE NO USER-SERVICABLE PARTS INSIDE. ALL SERVICING SHOULD BE REFERRED TO QUALIFIED SERVICE ENGINEERS.



**WARNING:** READ AND FOLLOW ALL THE SAFETY AND OPERATING INSTRUCTIONS BEFORE CONNECTING OR USING THIS UNIT. RETAIN THIS USER MANUAL FOR FUTURE REFERENCE. ALL WARNINGS ON THE UNIT AND ITS PACKAGING SHOULD BE READ AND FOLLOWED.



**WARNING:** This product contains a chemical known to the State of California to cause cancer and birth defects or other reproductive harm.



**CAUTION:** To reduce the risks of fire or electric shock do not expose this product to rain or moisture. Do not use this product near water; for example, near a bath tub, washbowl, kitchen sink, laundry tub, in a wet basement or near a swimming pool. Unplug the unit from the wall outlet before cleaning. Never use thinner, cleaning fluids, solvents or chemically impregnated cloths. For cleaning always use a soft dry cloth. Unplug this product during lightning storms or when unused for long periods of time.



**CAUTION:** The unit should be installed so that its location or position does not interfere with its proper ventilation. For example, it should not be situated on a bed, sofa, rug or similar surface that may block the ventilation openings; or placed in a built-in installation, such as a bookcase or cabinet, that may impede the flow of air through its ventilation openings. The unit should be situated from heat sources such as radiators, heat registers, stoves or other devices (including amplifiers) that produce heat. No naked flame sources, such as lighted candles, should be placed on, or near the unit.



**WARNING:** Do not place this unit on an unstable surface, cart, stand or tripod, bracket or table. The unit may fall, causing serious injury to a child or adult and serious damage to the unit. Use only with a cart, stand, tripod, bracket or table recommended by the manufacturer or sold with the unit. Any mounting of the device on a wall or ceiling should follow the manufacturer's instructions and should use a mounting accessory recommended by the manufacturer. An appliance and cart combination should be moved with care. Quick stops, excessive force and uneven surfaces may cause the appliance and cart combination to overturn. Use only with the cart, stand, tripod, bracket, or table specified by the manufacturer, or sold with the apparatus. When a cart is used, use caution when moving the cart/apparatus combination to avoid injury from tip-over.



**NOTE:** Should the unit become damaged beyond repair, or reaches the end of its life, please consult the regulations regarding disposal of electronic products in your region.



**NOTE:** KRK Systems, LLC cannot be held responsible for damage, and, or including data loss caused by improper use of the unit and or the applications provided for use with the unit.

## IMPORTANT SAFETY INSTRUCTIONS



**CAUTION TO PREVENT ELECTRIC SHOCK, MATCH WIDE BLADE OF PLUG TO WIDE SLOT FULLY INSERT.**

**ENGLISH:**The apparatus shall be connected to a Mains socket outlet with a protective earthing connection.  
**GERMAN:**Das Gerät ist eine Wandsteckdose mit einem Erdungsleiter angeschlossen werden.



**FRENCH:**L'appareil doit être connecté à une prise secteur avec connexion à la terre.

**SPANISH:**El aparato estará conectado a una toma de red eléctrica con una conexión a tierra.

**ITALIAN:** L'apparecchio deve essere collegato a una presa di rete con una connessione a terra protettiva.



1. The unit and power supply should only be connected to a power supply outlet only of the voltage and frequency marked on its casing.
2. Protect the power cable from being walked on or pinched particularly at plugs, convenience receptacles, and the point where they exit from the apparatus.
3. Do not defeat the safety purpose of the polarized or grounding-type plug. A polarized plug has two blades with one wider than the other. A grounding type plug has two blades and a third grounding prong. The wide blade or the third prong is provided for your safety. If the provided plug does not fit into your outlet, consult a qualified electrician for replacement of the obsolete outlet.
4. If the mains plug supplying this product incorporates a fuse then it should only be replaced with a fuse of identical or lower rupture value.
5. Never use a damaged or frayed power cable; this can introduce serious risk of exposing lethal voltages.
6. The power supply cable of the unit should be unplugged from the wall outlet when it is to be unused for a long period of time.
7. Only use attachments/accessories specified by the manufacturer.



**DO NOT ATTEMPT SERVICING OF THIS UNIT YOURSELF. REFER SERVICING TO QUALIFIED SERVICE PERSONNEL.**

Upon completion of any servicing or repairs, request the assurance that only Factory Authorized Replacement Parts with the same characteristics as the original parts have been used, and that the routine safety checks have been performed to guarantee that the equipment is in safe operating condition.



**REPLACEMENT WITH UNAUTHORIZED PARTS MAY RESULT IN FIRE, ELECTRIC SHOCK OR OTHER HAZARDS.**

**ATTENTION POUR ...VITER LES CHOC ELECTRIQUES, INTRODUIRE LA LAME LA PLUS LARGE DE LA FICHE DANS LA BORNE**

**CORRESPONDANTE DE LA PRISE ET POUSSER JUSQU'AU FOND.**



**This unit should be serviced by qualified service personnel when:**

- The power cord or the plug has been damaged
- Objects have fallen, or liquid has been spilled into the unit
- The unit has been exposed to rain or liquids of any kind
- The unit does not appear to operate normally or exhibits a marked change in performance
- The device has been dropped or the enclosure damaged.

### REGULATORY CERTIFICATION

KRK declare under our sole responsibility that this product, to which this declaration relates, is in conformity with the following standards:



The Declarations of Conformity can be obtained from 382 Ave. de la Couronne, B-1050 Brussels  
 Authorized European representative: Phone: +3226450500 Fax: +326450505

## Contents

Introduction .....	5
1. Method of Use .....	5
2. ERGO and RoomPerfect™ .....	6
3. Features .....	7
5. How ERGO works .....	8
6. System Block Diagram .....	8
7. Back Panel Connections .....	9
8. Front Panel Features .....	10
9. Placing your Monitoring System .....	11
10. Stereo Monitor Placement .....	12
11. Subwoofer Placement .....	13
12. Setting Monitor and Subwoofer Levels .....	14
13. Connecting ERGO to your monitoring system .....	15
19. Connecting ERGO to your computer .....	20
20. 1394/Firewire considerations .....	21
21. Preparing for Software/Driver Installation .....	22
22. Installation for Microsoft Windows Systems .....	23
23. Installation for Apple Mac OSX Systems .....	26
24. ERGO Calibration .....	29
25. Using ERGO Calibration Software (ERGO Cal) .....	30
26. ERGO Control Panel (Windows / Mac OSX) .....	40
27. Specifications .....	44
28. Frequently Asked Questions (FAQs) .....	45
29. Troubleshooting .....	47
30. Glossary .....	49
31. Further Assistance: .....	51
32. LEGAL .....	51

## Introduction

Thank you for purchasing your ERGO Room Correction and Audio Interface system. If you are already a KRK thanks for your continued use and support of our products. If you are new to KRK we are pleased that you chose ERGO as your room correction, we welcome you to our continually growing number of users. At KRK we strive to achieve the most honest, natural reproduction of your hard work. We encourage you to visit our website to see our industry standard Rokit monitors, class leading VXT monitors, Subwoofer solutions and the latest addition to the KRK portfolio, the KNS series headphones.

ERGO (Enhanced Room Geometry Optimization) is an exciting product that enhances the performance of any loudspeaker/monitoring system by digitally correcting both common and complex acoustic problems in the room.

## 1. Method of Use

ERGO can be used in two main ways:

- a. As an **audio interface (with room correction)** to hardware running Apple Mac OSX (Core Audio) or Microsoft Windows (DirectX-WDM/ASIO) operating systems, allowing full access to audio input and outputs for recording and monitoring, and room-correction.
- b. As a **stand-alone room correction device** which sits “in-line” with your monitoring signal path. This requires connection to your Apple Mac OSX or Microsoft Windows hardware for the room calibration process only, once complete ERGO can be disconnected to use in stand-alone mode providing room correction to the line input signal and supplying the corrected signal to your monitoring system

Both methods allow the following room correction options:

- a. **Dual Monitoring System**  
Two sets of stereo monitors which can be A/B switched from ERGO’s front panel
- b. **2.1 Monitoring System**  
A single set of stereo monitors and a dedicated subwoofer, in this mode the main monitors and the subwoofer can be individually muted when required

ERGO’s functionality is consistent between modes and all operational aspects are identical. For more on the functionality please see the section on connecting ERGO.

## 2. ERGO and RoomPerfect™

As the room itself is one of the most important factors when considering the re-production of audio signals it makes sense to take this issue seriously.

Room acoustics is without doubt a complex science and while we endorse and encourage physical room treatment we also understand that it can be fraught with difficulty and without proper expertise can often lead to undesirable results. Using baffles can sometimes result in timing and precision errors in the low frequency response of the room. Room issues such as resonance, ringing, absorption and reflections can be highly complex by nature and treatment can often have unwanted side effects. In the age of the project/professional studio quite often the room is a compromise, which can't be easily negated. Finally in a studio, which is constantly evolving with new equipment, and structure changes associated with them mean any previous physical correction results could be destroyed.

ERGO utilizes the RoomPerfect algorithm licensed from what we consider to be the authority on room correction, Lyngdorf Audio. This technology developed in Denmark uses highly complex test tones, multiple measurements and over one thousand EQ points to control your audio environment. The system can derive data on room modes, power response, directivity and LF roll-off, which inferior modes of correction do not account for. The RoomPerfect technology is exclusively licensed for KRK ERGO.

One fantastic advantage of ERGO's implementation of RoomPerfect is the Focus and Global modes of operation. In Focus mode the monitoring position/sweet spot is corrected and is the setting, which should be used during mixing. In Global mode the signal processing power is applied in a different way to correct the whole room, ideal for when artists, producers, A&R people want to all be in the room and it still sound right.

An important thing to note regarding the RoomPerfect algorithm is that one of the main advantages when compared to other methods of room correction. This ability to act as non-destructive correction actually maintains the character of your monitoring system. RoomPerfect does not try to remove the issues such as reflections and absorption as these are required to give us spatial positioning references, it actually adapts to them in a corrective manner.

The RoomPerfect algorithm in ERGO works on frequencies up to 500Hz, which equates to around 2ft, this works well in the studio environment where the user is working in a near-field mode and has a considerably smaller sweet spot than that of the home theatre. Lyngdorf offer a high end full-bandwidth solution for home theatre systems based on the same algorithms, which is considered by many to be one of the industry leading solutions.

Once your room is calibrated and ERGO is applying the RoomPerfect correction, you will notice the difference. Over time you will be able to "trust" the sound of your room, concentrate on your music, mix faster and more accurately, with results that will properly translate to other listening environments.

To read more about RoomPerfect and its benefits please visit the Lyngdorf Audio website: <http://www.lyngdorf.com/>

### 3. Features

- High-performance, state-of-the-art Digital Signal Processor for room correction and analysis
- Mastering grade Analog-to-Digital and Digital-to-Analog converters
- Can be used as an Audio Interface with room correction, or Stand Alone room correction
- Balanced ¼" TRS Line Inputs
- Balanced ¼" Line Outputs for dual system connection (A/B) or 2.1 Connection (A+B)
- Large Illuminated Analog Volume Control
- Illuminated Headphones control
- Illuminated Monitor Selection buttons
- Focus/Global/Bypass Mode controlled by illuminated button
- Patented RoomPerfect™ technology corrects phase and frequency problems
- ERGO Cal Software compatible with OSX and Windows platforms.
- Professional calibrated measurement microphone and microphone stand adapter.

As ERGO uses new some new technology you may not be familiar with, please refer to the glossary at the back of this manual to get more information about any of the terms used.

### 4. ERGO Package

Your ERGO package contains the following items:

- **ERGO hardware interface**, containing the monitoring controls, Digital Signal Processing, A/D-D/A convertors and input/output connectors.
- **ERGO Microphone** – Calibrated measurement microphone used when calibrating the room only
- **ERGO Microphone Adapter**, If your microphone cable has an XLR connection, this cable allows it to be converted to a ¼" TRS connection for use with ERGO.
- **ERGO Installation Disc** – This contains the relevant installer for your system and an electronic copy of this user guide.
- **6-pin to 6-pin 1394a (Firewire 400) cable** for connecting ERGO to your OSX or Windows hardware.

## 5. How ERGO works

ERGO takes a stereo audio stream from the analog or digital (S/PDIF or FireWire input) domain and processes it through a 96 kHz room correction algorithm. All incoming analog audio is sampled at 96 kHz, while incoming digital audio is sample rate converted up to 96 kHz for processing. If incoming audio comes in over FireWire, the processed audio is converted to reflect the output frequency of the ASIO driver, up to 96 kHz. In Digital Input mode, the output frequency and the audio going to your monitors is going through digital to analog converters fixed at 96 kHz sample rates.

ERGO's architecture provides the best audio quality while maintaining compatibility with existing systems. In fact, the audio converters used in ERGO are the same as those found in multi-thousand dollar audio workstation hardware.

## 6. System Block Diagram

Below is shown the internal architecture and signal path:

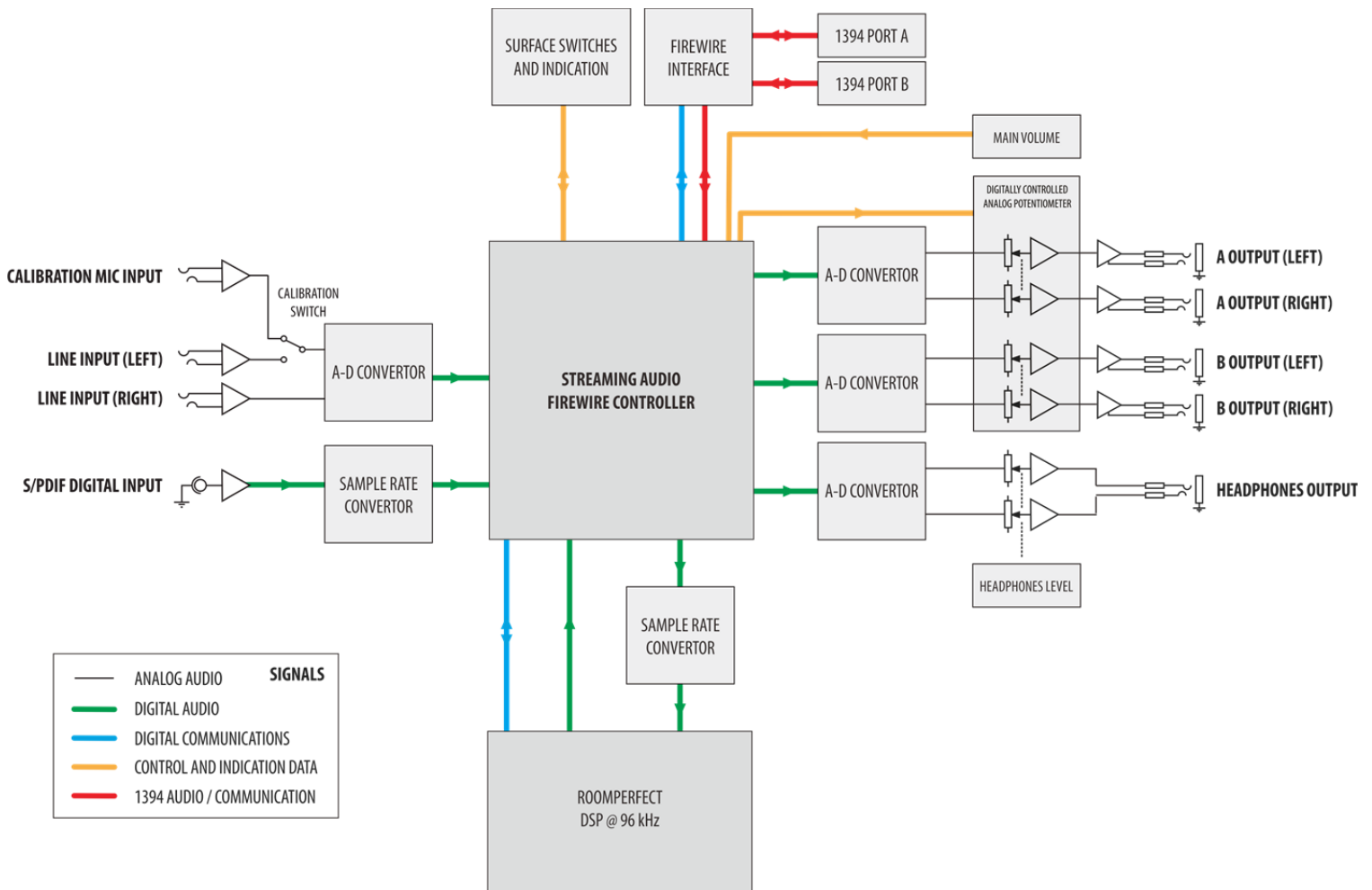



## 7. Back Panel Connections

- A. **Power On Switch** – This turns the unit on/off.
- B. **Power Input Socket** – This accepts a 12V/1A input from the power supply included with ERGO.
- C. **Firewire Ports** - These 2 ports allow connection and daisy chaining of FireWire devices.
- D. **S/PDIF Digital Input** – This allows connection of a digital input source from a playback device or another audio interface.
- E. **Calibration Microphone Input** - This jack is used to connect the ERGO measurement microphone. It is only used during the calibration process. It is recommended that you only use the microphone supplied with ERGO for room calibration. ERGO supplies a 15V phantom power source to its microphone, and using other microphones for calibration may result in poor room analysis and improper correction filters.
- F. **Balanced ¼" TRS Analog Line Inputs** – These connections are used either as inputs from your existing audio interface or as recording inputs from a mixer, or rack channel.
- G. **Calibrate Button** – This requires switching manually during the calibration process, you will be told when to engage and disengage it.
- H. **Balanced ¼" TRS Analog Line Outputs** – These connections are used to connect to your monitoring system. Dual monitor systems can be connected to A/B, or 2.1 systems with subwoofers can be connected to A+B.
- I. **Headphones Output** – Headphones can be connected here to monitor the signal being sent to your monitors, or as an individual Solo/Cue feed.
- J. **Kensington™ Security Lock** – Used to secure the unit via a Kensington Security Device (purchased separately if required)



## 8. Front Panel Features

- A. **A** – This button will select the A monitoring system if using in dual monitor mode, this button will enable/disable the main monitors if used in a 2.1 audio system..
- B. **B/SUB** – This button will select the B monitoring system if using in dual monitor mode, this button will enable/disable the subwoofer if used in a 2.1 audio system.
- C. **Focus/Global/Bypass** – This button switches between three modes: FOCUS (Illuminated), GLOBAL (off) and BYPASS (Flashing). **Note:** to put ERGO into bypass mode you **must press and hold this button**.
- D. **Clip Indicator** – This will illuminate red when audio is 3dB below full scale, indicating a likely clip condition.
- E. **Power / Firewire Indicator** – This will illuminate GREEN to show power is ON and the Firewire connection is operational. This will illuminate RED to show power is ON and the unit is in Stand-Alone mode.
- F. **Calibration Indicator** – This will illuminate when the calibrate button is ON.
- G. **Volume/Level Control** – This large high resolution control adjusts the output level sent to your selected monitoring system
- H. **Headphones Level Control (Located on Side Panel)** – The headphones output level control is an illuminated dial on the left hand side of the unit. NOTE: The high quality headphone amp in ERGO is capable of providing a high output level to certain headphones, please start with a low level and rise slowly to maintain comfortable and non-damaging levels. Your ears are the most important tools of your trade.



## 9. Placing your Monitoring System

Your monitors may already be positioned exactly where you need them for many other reasons, if this is the case you can move to the next section and start connecting ERGO.

If you are positioning your monitors for the first time, or have an opportunity to re-position your monitors we strongly advise reading this section. One of the great advantages of ERGO and the RoomPerfect technology is overcoming some traditional limitations.

When it comes to placement of traditional monitors it is actually possible to think differently with ERGO because of its use of RoomPerfect™, i.e. to break away from conventional 'free space' placement.

Normally, you need to choose a monitor placement well away from rear and sidewalls to secure the best possible frequency response. Due to the fact that a traditional monitor has Omni polar dispersion in the bass region, this 'free space' placement has a big disadvantage namely that you actually risk 'destroying' the impulse response. The reason for this is that you hear both the direct sound from the speaker and later all the reflections from the walls. The reflections are delayed as a consequence of the distance to the walls and will therefore arrive later thus smearing the 'attack' of e.g. a drumbeat. Typically back wall reflections are the most annoying because they arrive from the same direction as the direct sound from the loudspeaker. Sidewall reflections are easier for the brain to cope with because they arrive from another direction. Therefore they are often regarded as adding ambience and localization clues.

The close or near-field monitor reduces room interaction. This can be compared to the conventional stereo configuration or the large monitor arrangement in a recording studio where sounds emanating from the monitor or reflecting off ceilings, walls, and floors greatly affect the sound quality.

If you place the loudspeaker close to the back wall the bass reflections from the wall and the direct sound will arrive simultaneously at the listening position – i.e. the impulse response in the bass region can be improved considerably and ERGO can easily compensate for the uneven frequency response as a consequence of the placement. So, with ERGO it can actually be an advantage to choose what's normally regarded as a less ideal 'close wall' loudspeaker placement as this will not only improve the impulse response.

Also, when compensating for the increased efficiency, the load on both amplifier and loudspeaker is decreased resulting in less distortion and better headroom is achieved. And taking energy out of the system also has another advantage because delivering less energy into the room means that room modes are less excited. From this a much more even power response across the room is achieved – i.e. the differences between peaks and dips in the response are reduced dramatically.

The result you see after calibration is that the "Room Correction Index" will also be quite high since correction in the bass region is needed. However, the index number is not high because you have a 'poor' system – it's high just because you have chosen a loudspeaker position that improves the impulse response but then requires compensation for the increased efficiency in the bass region. Try it out and see what works for you – near wall or 'free space' placement - ERGO works in both cases.

## 10. Stereo Monitor Placement

There are two basic elements to consider before achieving the best possible performance from your monitors:

- a. **Room Correction / Treatment** - either acoustic, or digital (as ERGO) or a combination of these methods.
- b. **Optimal Positioning** – This covers the placement of all monitors, and subwoofers in the room.

If you attempt any kind of acoustic treatment we recommend you hire a qualified studio acoustician who can identify and rectify the acoustic shortcomings of your control room. You will hear a lot of talk about standing waves, flutter, decay time, absorption and reflection, and it may be expensive, but if you run a commercial recording space, consider it the cost of doing business. If you plan to use ERGO only, without acoustic room treatment this Section will take you through the procedure of placing your monitors using some common examples.

### Where to Start?

Typically, they should be placed so that the listening position is fully “covered” with all monitors resting on the same horizontal plane. To test a monitor for its imaging capability, playback a song that includes acoustic instruments, to fully represent the entire sound spectrum. You can adjust the angle of each monitor by listening for dead spots. Keep in mind, changing the angle or position of a monitor will change the way that you perceive your music. So let’s analyze a few examples:

### Close / Near-Field

In a control room, the monitors are frequently placed on the meter bridge or in a close-field listening position of a DAW workstation console. Initial placement starts by measuring out a simple equilateral triangle (all three sides equal in length) with the apex at the center of the listening position (as shown in Figure 1) as an “overlay” for the stereo installation. In this configuration, the Left and Right monitors are each placed at a 60° angle equidistant from the listening position.

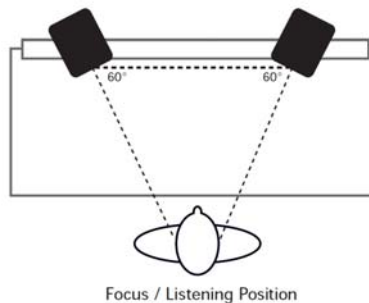

### Mid-Field / Rear Stands Positioning

This configuration is similar to the close/near-field configuration. It is normally used with larger monitors or when the monitors are too large or heavy for the meter bridge. This set up has the potential for a larger sweet spot and better spatial imaging. Make sure that the height of the woofer cone is above the height of the console to avoid reflections and comb filtering effects.

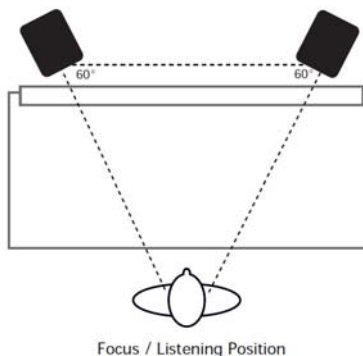

## 11. Subwoofer Placement

**Note:** A properly set up subwoofer system extends the bass response of the main stereo monitors down into the 30-Hz range, but without exaggerating bass response in the room. Improper setup may cause an exaggeration of bass response in the room, which in turn may cause the engineer to mix in less bass energy than desired. We recommend paying close attention when configuring your subwoofer.

Bass frequencies are largely non-directional, however that does not mean that you should ignore the subwoofer's placement in the room. In fact, a sub's physical position in the room in relation to the floor, walls and other surfaces radically influences its bass response. In a monitoring situation, it is desirable to place the subwoofer so that it produces the smoothest frequency response at the listening position. In addition, since the subwoofer's output will interact with the other monitor speakers in the room, it is important to consider the subwoofer and near-field speakers as a total system.

If you have access to a Real Time Analyzer and a calibration microphone, then setting up the room can be fairly painless. There are good selections of iPhone/Smartphone applications which will allow your device to measure SPL. However, it can also be done with a generic SPL meter, or even your own ears, once you know what to listen for.

What you are attempting to do is find a place in the room where the subwoofer interacts smoothly with the acoustics to even out the bass response at the listening position. One way to do this is to reverse the normal position of the subwoofer and listening spot by temporarily moving the subwoofer to your seat position in front of the console. Then play back pink noise in the 30 to 80 Hz range or music with robust bass information. Now by moving the SPL meter (or your ears) around the various potential speaker positions in the room, you can listen for where the bass sounds the loudest. That is where the speaker loading would potentially be at its greatest. Once you find the optimal spot, place the subwoofer at that position and listen to it from the console position. Even without an SPL meter you can then use stepped band-pass, pink noise and sine-wave sweeps to evaluate how even the bass response is. Move the subwoofer around a foot at a time until the bass response is as even as possible at the listening position.

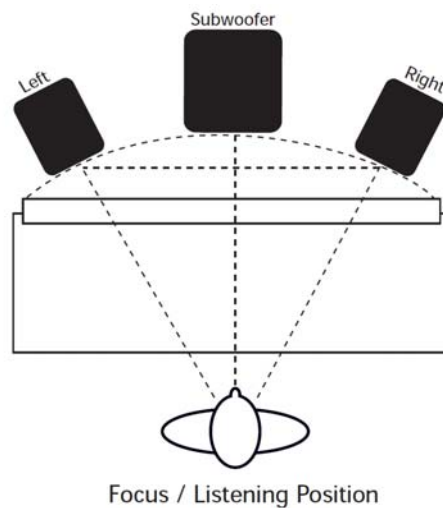

## 12. Setting Monitor and Subwoofer Levels

Once the stereo monitors and subwoofer are in position, their levels need to be matched. The process is straightforward and is described below:

Obtain an SPL (Sound Pressure Level) meter, these are very cheap and are now commonly available as Smartphone/iPhone applications. Set the low-pass filter on the subwoofer back plate to 80 Hz

Send a one octave wide, band-pass pink noise signal to your monitoring system (the main speakers from ERGO, or from the subwoofer if using the internal crossover). A good choice is 500 to 1,000 Hz band-passed pink noise, which is within the fundamental frequency range of many vocalists, and minimizes high-frequency problems but doesn't excite the subwoofer. Adjust your main monitors until you reach a comfortable monitoring level. (Typically 85 decibels SPL using the C response curve on the SPL meter)

Next, route 1-octave, band-passed, bass pink noise to the subwoofer to the monitor system. A good noise choice is 35 to 70 Hz, which is below the 80-Hz frequency of the subwoofer high-pass filter, but sufficiently high enough that most subwoofers will have adequate response in that band. Set the gain of the subwoofer level control until it matches the same 85-decibel SPL level. Then, turn up the low-pass filter control on the subwoofer to 130 Hz. This allows the bass energy between the near-field speakers and subwoofer to overlap.

Listen from the mix position and route pink noise with a band-pass of 80 Hz to 130 Hz to your monitoring system. Have someone adjust the phase on the subwoofer (ideally a full 360 degrees), and then back, and note the position which sounds loudest. The loudest position is correct and in phase. Now return the low-pass filter to the 80-Hz position (or another frequency if you are using external high-pass filters for the near-field speakers).

Your system should now be properly aligned for phase, level and spectral response.



### 13. Connecting ERGO to your monitoring system

ERGO is very flexible, it has connections which allow it to be integrated into several different configurations. The following pages cover some of the more common examples.

**Note:** At this point now your monitors are positioned you should choose your configuration and make a note of it then move to the next section and begin Installing ERGO.

### 14. Connecting ERGO as an audio interface with a dual stereo monitoring system

Below is the standard configuration when using ERGO as an audio interface with room correction for two pairs of stereo studio monitors:

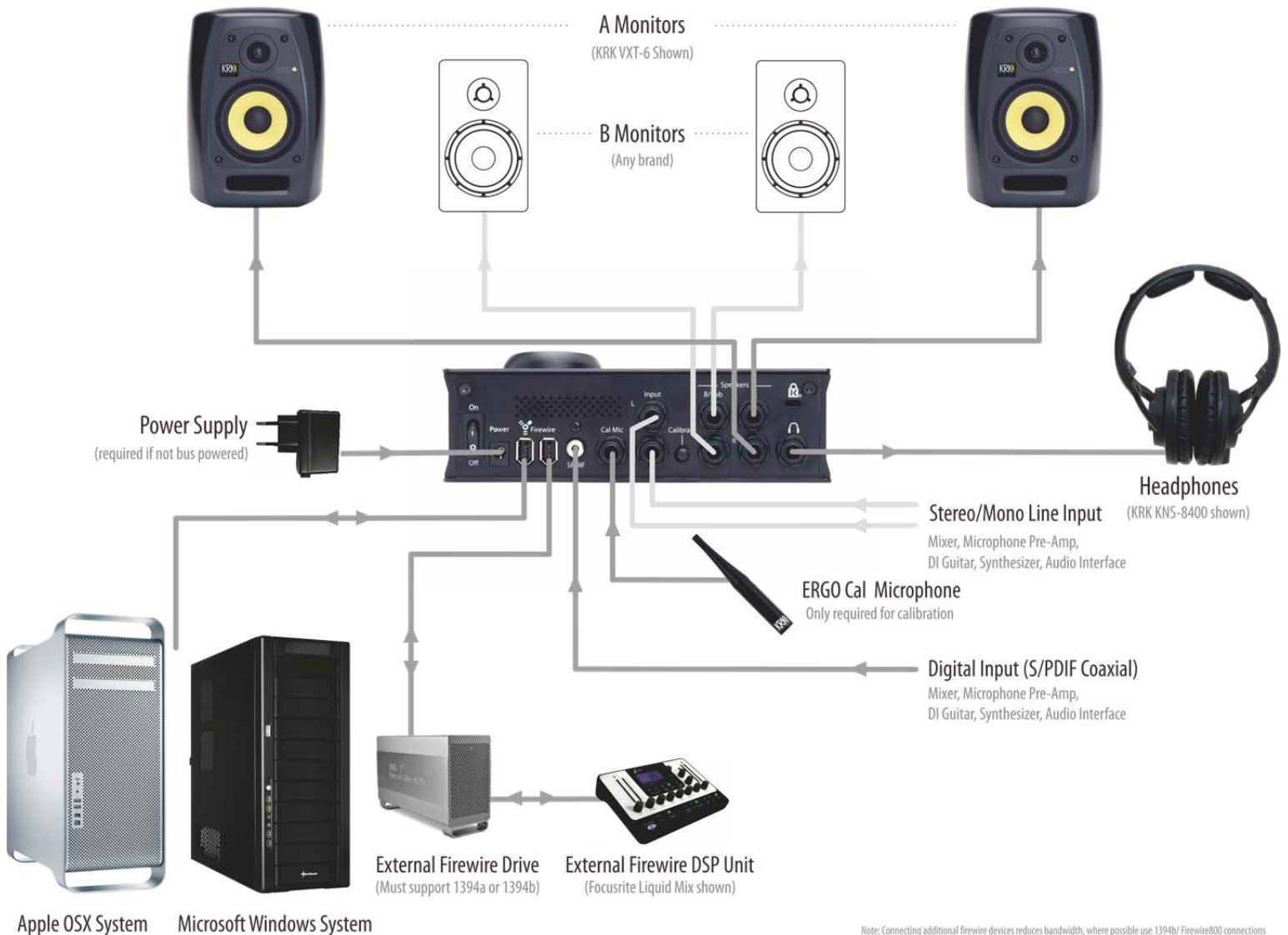

## 15. Connecting ERGO as an audio interface with a 2.1 monitoring system

Below is the standard configuration when using ERGO as an audio interface with room correction for a single set of stereo monitors augmented by a subwoofer. Here ERGO allows the user to adjust the crossover frequency from the control panel while you are in the sweet spot. The subwoofer can also be muted from the control panel.

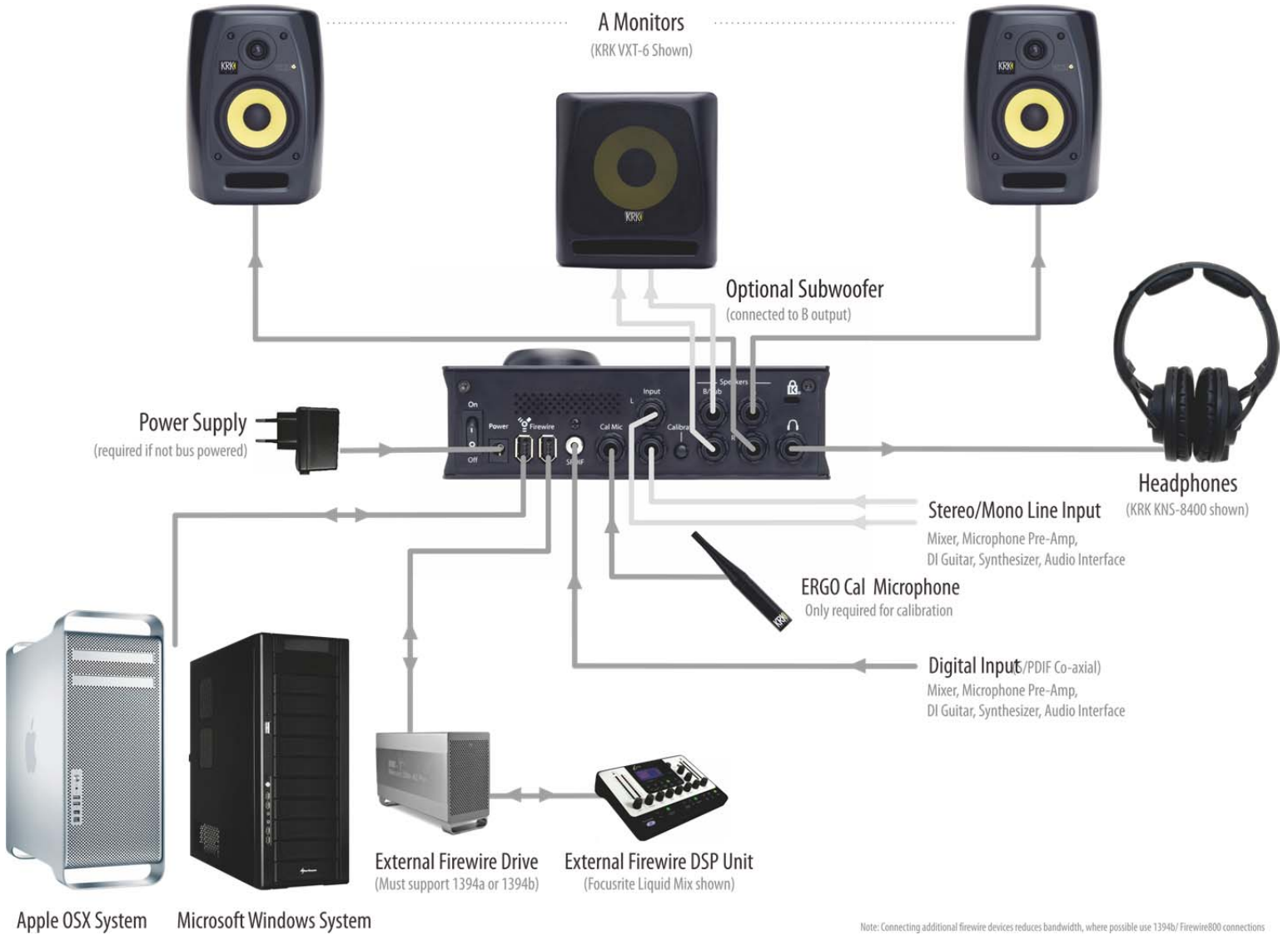

Note: Connecting additional firewire devices reduces bandwidth, where possible use 1394b/ Firewire800 connections



## 16. Connecting ERGO to an audio interface using dual 2.1 monitoring systems.

Below is the standard configuration when using ERGO as an audio interface with room correction for two pairs of stereo studio monitors, both augmented by subwoofers. Here the subwoofer takes the signals from audio and performs crossover functionality before passing the high pass filtered output to the main monitors, Note: in this configuration the sub can only be bypassed using a footswitch where possible. **Note:** ERGO uses a mono summed signal from the B Left output only, this should be the only connection you make to your subwoofers LEFT input.

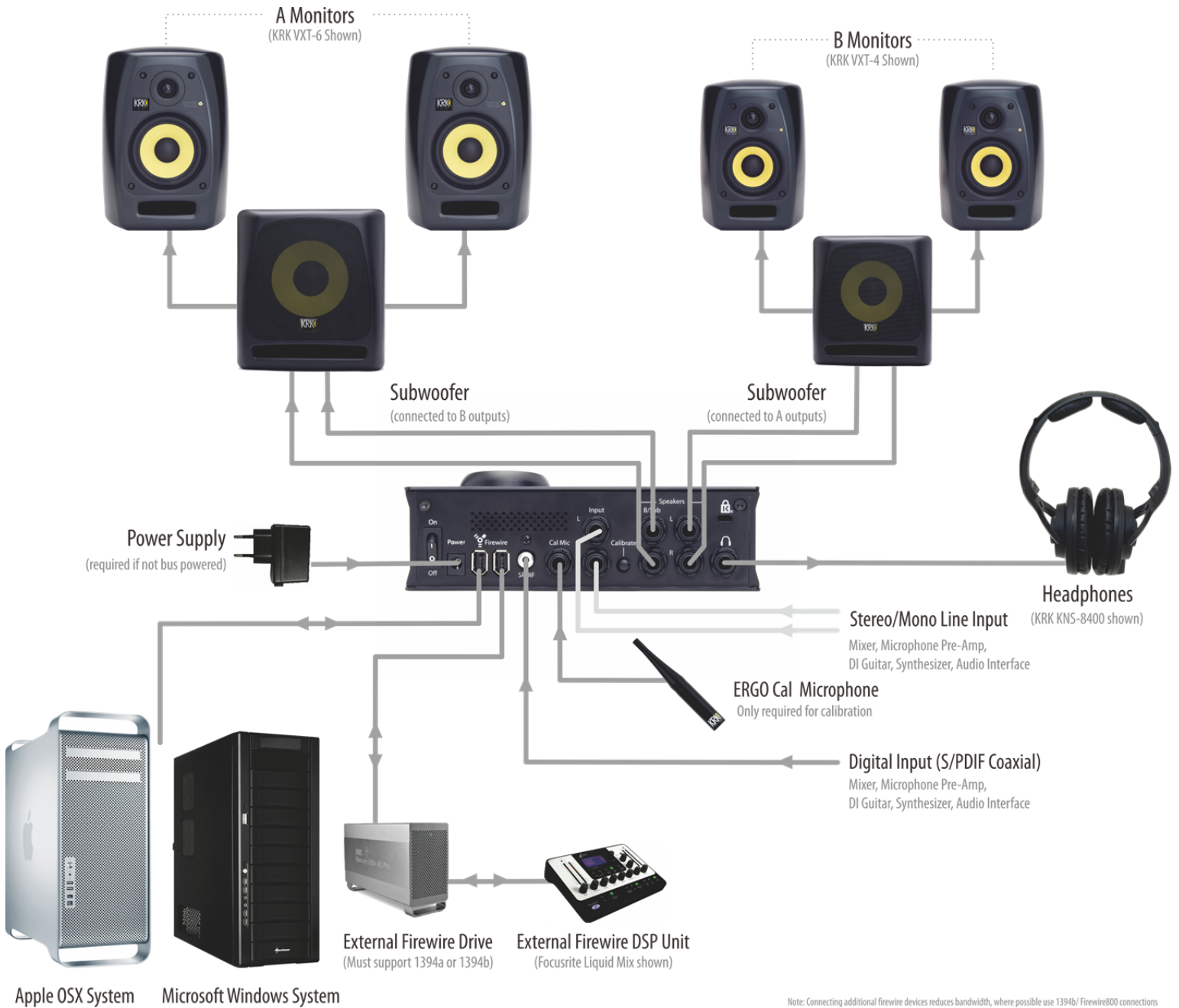

Note: Connecting additional firewire devices reduces bandwidth, where possible use 1394b/ Firewire800 connections

## 17. Connecting ERGO as a “stand-alone” device

Below is the standard configuration when using ERGO as stand-alone device. Here ERGO simply sits in the path of your existing monitor feed. In this mode ERGO will perform correction on the signal appearing at either the digital or analog inputs. Note: The digital inputs are treated as a priority, so if an S/PDIF source is connected it will be used instead of the analog input. If you wish to use the analog inputs please ensure a digital source is not connected.

In this mode, the controls all operate according to the mode calibrations were performed (with or without Subwoofer). Below a 2.1 system is shown, you can also apply the same principle using a dual stereo monitoring system. **Note:** ERGO uses a mono summed signal from the B Left output only, this should be the only connection you make to your subwoofers LEFT input.

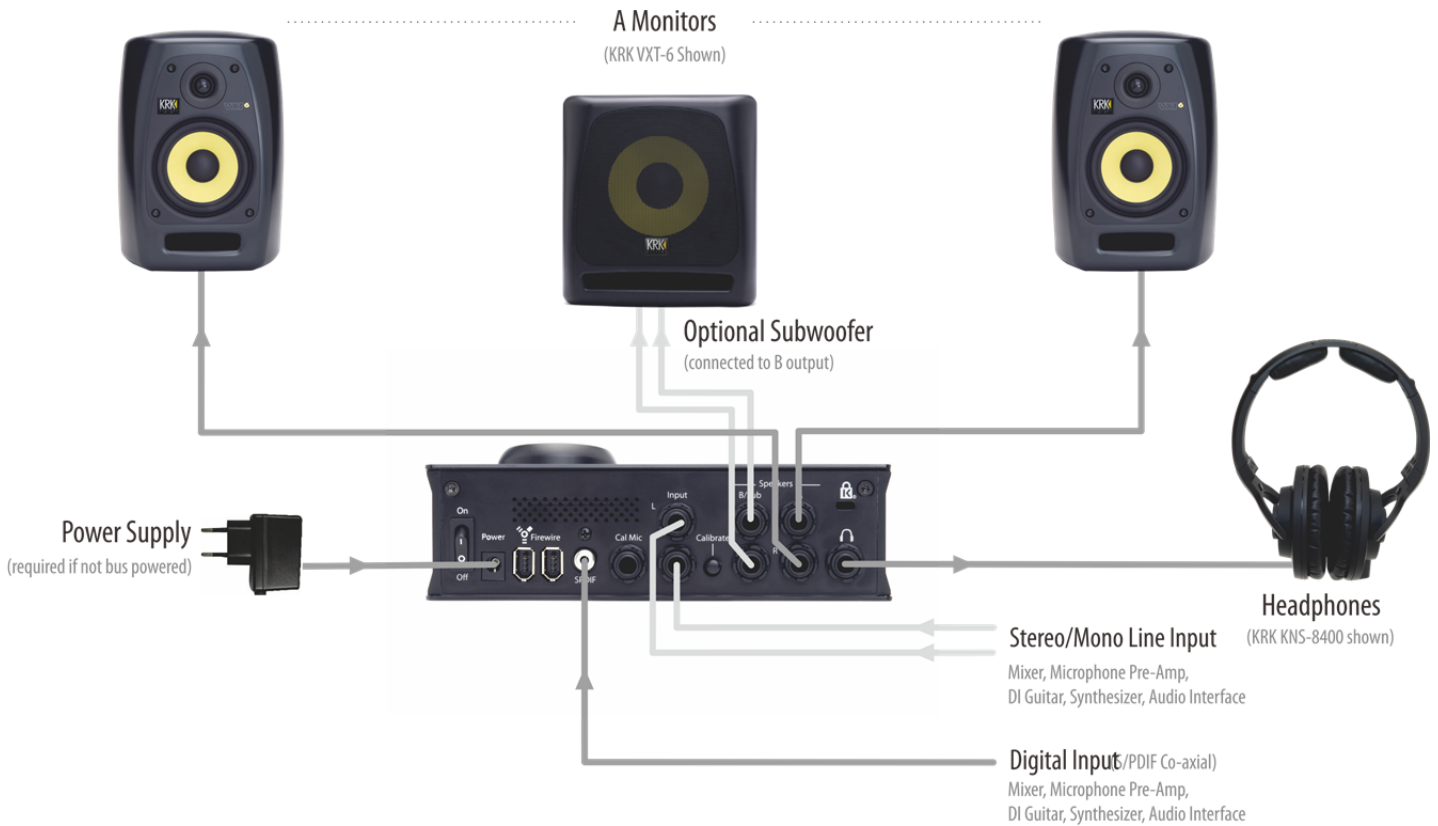

## 18. Connecting ERGO to an existing audio interface

This configuration is identical to using ERGO as stand-alone device. Here ERGO simply sits in the path between your existing audio interface and your monitors. In this mode ERGO will perform correction on the signal appearing at either the digital or analog inputs. Note: The digital inputs are treated as a priority, so if an S/PDIF source is connected it will be used instead of the analog input. If you wish to use the analog inputs please ensure a digital source is not connected.

In this mode, the controls all operate according to the mode calibrations were performed (with or without Subwoofer). Below a simple dual monitor system is shown, you can also apply the same principle using a 2.1 system.

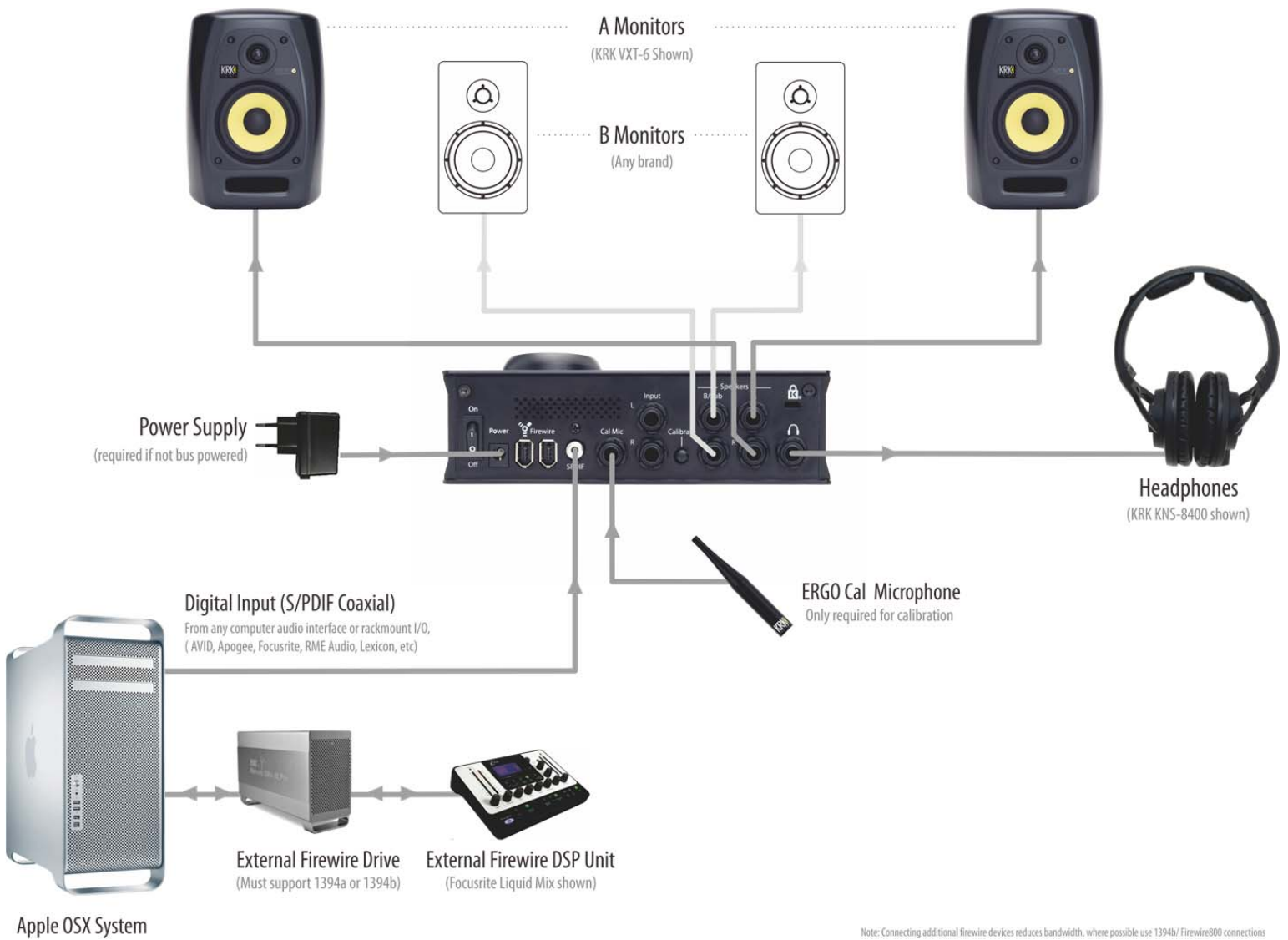

## 19. Connecting ERGO to your computer

### A. System Requirements

**Note:** If using in Stand-Alone mode a connection to an Apple Mac OSX, or Microsoft windows computer is only required for performing room measurement and analysis.

The Minimum required computer specifications for calibration or use as an audio interface (with room correction) are listed below:

Microsoft Windows 7 (32/64-bit)  
Microsoft Windows Vista (32/64-bit)  
Microsoft Windows XP (SP2 or later) (32-bit)

1GB RAM, 10 MB hard disk space, 800 x 600 monitor resolution (or higher)  
4 or 6-pin FireWire port (6-pin port required to FireWire to supply power to ERGO)  
AC outlet (for ERGO power supply if power is not supplied via FireWire).

Apple Mac OSX 10.6.x (Snow Leopard 64-bit)  
Apple Mac OSX 10.5.x (Leopard 32-bit)  
Apple Mac 10.4.x is not supported, but can be utilized by using Apple FireWire driver 2.2.0.

1GB RAM, 10 MB hard disk space, 800 x 600 monitor resolution (or higher)  
4 or 6-pin FireWire port (6-pin port required to FireWire to supply power to ERGO)  
AC outlet (for ERGO power supply if power is not supplied via FireWire).

### c. Power considerations

ERGO can be powered in two ways:

**External Power Supply** – This requires use of the supplied 12VDC/1A supply, which is included.

**Firewire Bus Power** – Using the power provided by the Firewire port (if available), please see more information on Firewire bus power in the next section.

## 20. 1394/Firewire considerations

### a. The Firewire Bus

Most computers will generally be equipped with a single Firewire bus connection. You may have multiple Firewire ports (connectors) on your computer, but these are all normally connected to one physical chip, which controls the bus.

The Firewire bus is limited in the amount of data bandwidth it can handle. Each additional Firewire device connected to the Firewire bus demands additional bandwidth resources, thus increasing the chances of exceeded the total available bandwidth. Consequently, it is recommended that ERGO be the only device connected to the Firewire bus for best possible performance. ERGO and other devices connected to the same Firewire bus should work but of course there are limitations which are dependent on their use.

Problems may arise depending on which Firewire devices are connected. For example, a Firewire disk used for back-up or a digital camera should not cause any problems, but when streaming audio from a Firewire hard disk or a Firewire DSP Unit, the total Firewire bandwidth may be reached. This will result in audio dropouts, or reduced performance on either ERGO or the other connected Firewire device. For this reason, we would recommend that you use a separate Firewire bus for each Firewire device. This may be a PCI / PCIe card in your desktop, or a PCMCIA or Express card in your Laptop. ERGO has been tested successfully with many other devices, but cannot guarantee audio streaming as this is dependent on usage.

### b. FireWire Chipsets

High definition audio flowing over FireWire requires a consistent stream between the chipset in the host computer and the chipset in ERGO. Unfortunately, some FireWire chipsets have known issues when it comes to the reliability and synchronization required for streaming audio. It is suggested to only use the best quality branded PCI and PCMCIA cards from professional manufacturers.

### c. FireWire Cables

Another issue that can degrade Firewire performance is cable quality. Many cables, even ones that feel like quality cables, do not adhere to the IEEE 1394 specification. Improper shielding and/or grounding are common causes of cable issues, always ensure you use the cable supplied with ERGO, or if connecting to a 4-pin or 9-pin port, we advise purchasing high quality cables from good quality, branded suppliers.

### d. Firewire Bus Power

This requires use of the 6-pin to 6-pin Firewire cable supplied with your product or the use of a 9-pin to 6-pin cable (purchased separately)

**Note:** bus-power is only available on 6-pin and 9-pin Firewire connections, if connecting to a laptop which only has a 4-pin Firewire connector you will need to use the external power supply and a 4-pin to 6-pin cable (purchased separately).

## 21. Preparing for Software/Driver Installation

Once you have selected your configuration, and read the install notes you can go ahead and start connecting the system, there are some simple rules to follow:

Do not turn your powered monitors (or amplifier) on until the system is totally connected, and all devices upstream are powered and running normally. This is good studio common sense and prevents your monitors trying to reproduce and potentially harmful sounds which occur when turning on other hardware.

Avoid crossing power and data cables, or winding either in circles, this can lead to degraded performance.

Always use the best quality cables you have access to, this will ensure you get long-term reliability and improve performance.

So now you have positioned and connected your monitoring system and you are prepared with the right knowledge to connect to your computer via Firewire. The next step is to install ERGO's drivers and software on to your computer.

## 22. Installation for Microsoft Windows Systems

**Note: Please ensure ERGO is not connected to your computer before starting this procedure**

1. If you have downloaded the zipped file from the website please unzip the file by double clicking the icon with your left mouse button. (Note: If you are installing from CD please refer to the ReadMe.rtf file on the CD and follow the additional instructions)



2. This will open a folder showing the installer"



3. Start the installer by double clicking the icon with your left mouse button: 
4. Windows will ask one or two questions at this step.
5. If using Windows 7 or Windows Vista you may be asked to "Install" or "Don't Install", please confirm by pressing "Install". If you receive a message asking to confirm the installation, you probably have security settings which require you to manually confirm any installations. Please check the message in the warning window regarding how to change your options if desired.
6. You may be asked for confirmation to "Run" the program, please press "Run" to start the installer.

7. After these messages, you will see the screen below; please quit any running applications and press “Next” to continue.



8. You will see the following screen. Again ensure ERGO is not connected to your system yet then press “Next” to begin installing the driver





10. On the lower part of your screen you will see the progress bar in the installer window and file information as the necessary files are installed.



11. During this stage the drivers are installed and Windows may also ask about Windows Logo Testing please confirm by pressing "Continue Anyway".
12. The installer will place a folder called "ERGO" within your "Programs" folder. Within that folder you will find the ERGO Control Panel and ERGO Cal application, as shown below. You can create shortcuts on your desktop for easy access or drag these to your dock. There is also a ReadMe file which is a guide to configuration, which is a cut down version of this manual to aid getting set-up quickly.



ERGO Control Panel



ERGO Cal

13. Once the process is completed you will see the screen below. At this point you can now connect ERGO to your computer and begin the calibration process described later in this document.
14. **Note:** The first time you connect ERGO to your computer you will see driver install messages near your system clock at the lower right of your screen. This is expected and once the messages are clear you may move on.

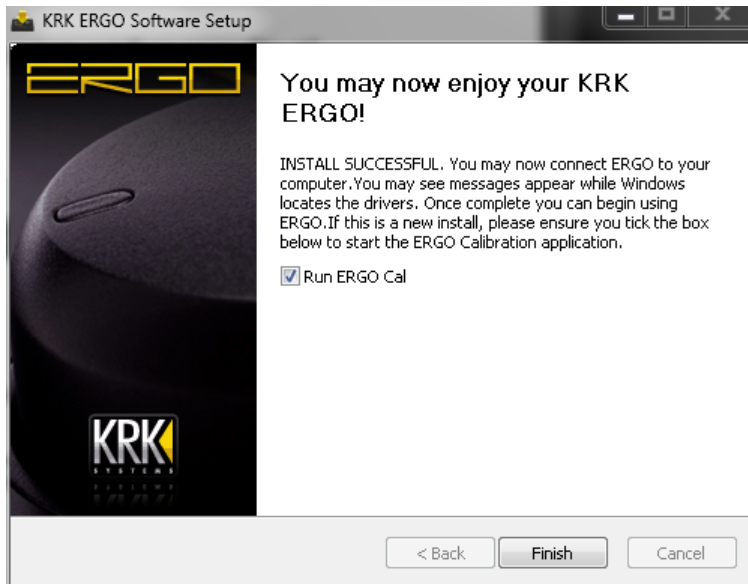

15. At this point you can now connect ERGO to your computer and begin the calibration process described in the next section.

## 23. Installation for Apple Mac OSX Systems

**Note: Please ensure ERGO is not connected to your computer before starting this procedure:**

NOTE – Always check [www.krksys.com](http://www.krksys.com) for the latest ergo firmware, drivers and software. Running the latest installer will ensure that the correct drivers are used, thus preventing any unexpected behavior.

1. If you have downloaded the .dmg compressed file from the website please unzip the file by double clicking the icon with your left mouse button **⌘** (Note: If you are installing from CD please refer to the ReadMe.rtf file on the CD and follow the additional instructions)



ERGO Software v1.07.dmg

2. This will open a folder showing the installer package



ERGO Software v1.07

3. Start the installer by double clicking the icon with your left mouse button: **⌘**
4. You will then see screen below; please quit any running applications and press “Continue” to move on.



5. You will see the following screen. Again ensure ERGO is not connected to your system yet then press "Install" to continue.

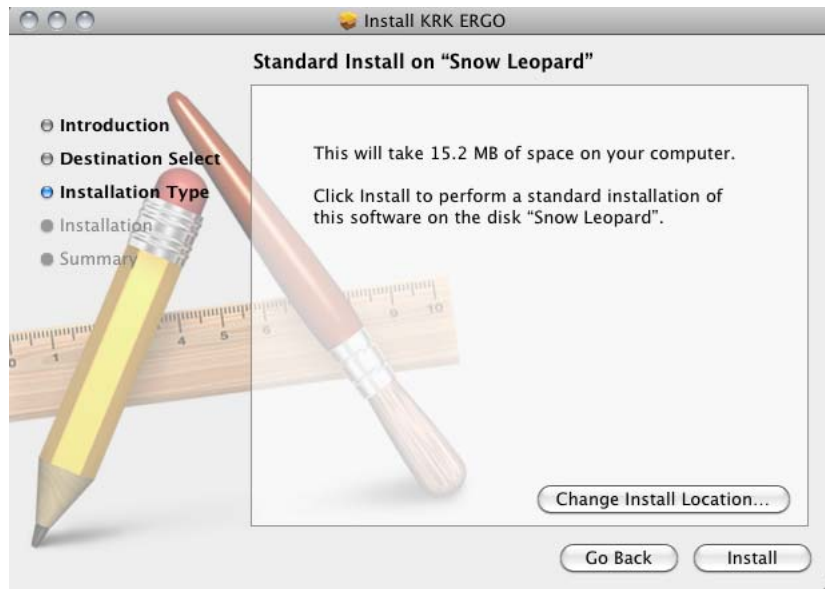

6. Next, you will need to enter your systems password to allow the installer to make changes. If you don't have a password just leave the password field blank and press "OK" to continue.



7. Once the process is completed you will see the screen below.

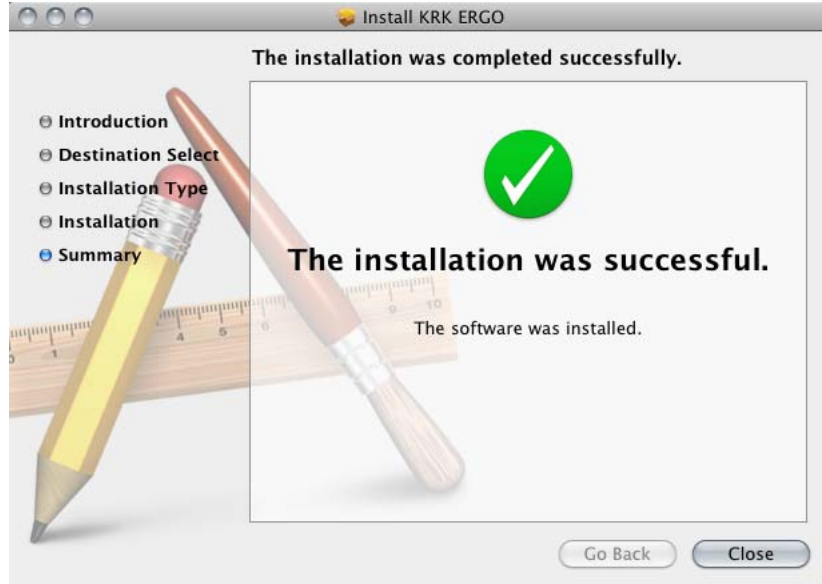

8. The installer will place a folder called "ERGO" within your "Applications folder" within that folder you will find the ERGO Control Panel and ERGO Cal application, as shown below. You can create shortcuts on your desktop for easy access or drag these to your dock. The installer will automatically open a "ReadMe" file in TextEdit which is a guide to configuration, which is a cut down version of this manual to aid getting set-up quickly. If using this manual you can disregard that document and close TextEdit



ERGO Control Panel



ERGO Cal

9. At this point you can now connect ERGO to your computer and begin the calibration process described in the next section:

## 24. ERGO Calibration

Before you start calibrating:

ERGO's room correction consists of two stages:

- a. **Measurement and Analysis** this technique, aka "Shooting the room" is the procedure we will follow the procedure to gain what is known as "Room Knowledge" and is the information required to perform correction.
- b. **Calculating, Applying and Storing** this is where the correction required is first calculated based on the Room Knowledge, then applies to the selected monitors and stored within ERGO

ERGO relies on a new way of measuring the room. Using traditional test signals such as pink noise normally means a trade-off between signal-to noise ratio (SNR) and frequency resolution. Long analysis windows lead to high frequency resolution but poor SNR due to the low number of averages. But using multiple pure tones means long analysis windows (5.5 seconds for low frequency test signal) leading to both high frequency resolution (0.2 Hz) AND an excellent SNR due to very narrow analysis bandwidth in the frequency domain, something which is almost insensitive to normal broadband background noise. ERGO generates energy at the very same frequencies where the analysis takes place, that is energy and processing is not wasted by measuring the spaces in between the analysis frequencies. Because traditional 1/3 octave measurement and correction (three frequencies for each doubling of frequency) is not sufficient for room correction ERGO will perform improved and more accurate correction.

The measurement at the listening position holds information about the operators access to the sound-field while the room positions hold information about the 3 dimensional sound-field in the entire listening room. This allows ERGO to apply the required correction for the operator in the "sweet spot" (FOCUS MODE), or for the entire room (GLOBAL MODE)

In a new ERGO installation, the software guides you through the set up sequence, indicates when to move the microphone, monitors the quality of the measurements, and continues the process until the necessary information is retrieved and the filters for "global" and "focused" correction can be calculated.

## 25. Using ERGO Calibration Software (ERGO Cal)

**Note:** Do not plug headphones in at this stage; the tones played through ERGO during calibration should not be monitored.

Please now connect the measurement microphone provided with ERGO. **Note:** This microphone is specifically designed to be flat over the range of ERGO's measurements. Please do not use any other type of condenser, or dynamic microphone as the power supplied is +/- 15v and may damage, or not sufficiently power a condenser variant. You will need a microphone cable which is long enough to reach all areas of your room. Please use the cable adaptor supplied to adapt a traditional microphone cable (Male XR to Female XLR).

If this is a new install and ERGO Cal has already been auto-started, please move to step B

1. Double-click the left button of your mouse on the ERGO Cal icon (For Windows this will be a shortcut on the desktop, or in a folder called KRK ERGO within your "Programs" folder, For Mac OSX this will be a folder called ERGO within you "Applications")



2. Once you initialize ERGO Cal, the following screen appears:

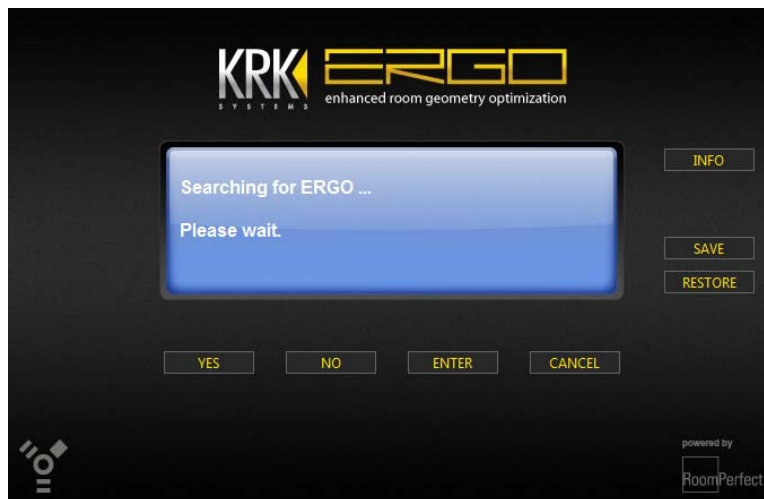

- ERGO Cal will now search for ERGO and begin communicating, once complete you will see this message:

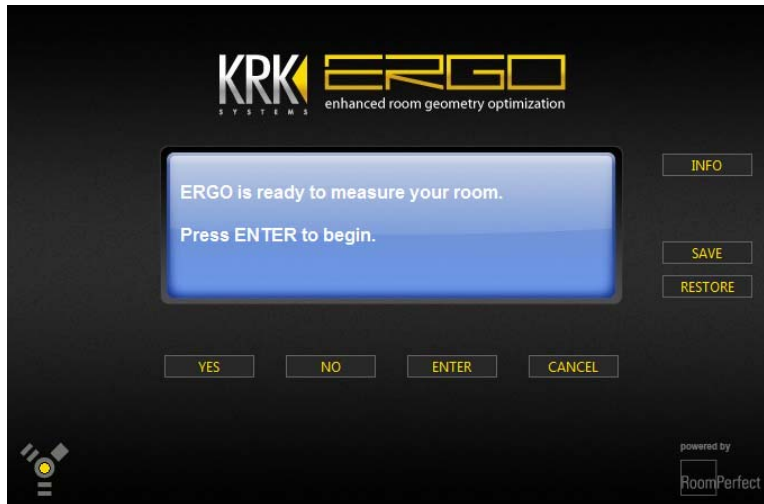

- Now ERGO Cal has detected you ERGO unit, please press the info button on the right hand of the current window. This will open ERGO Cal's info window, which gives you information regarding your calibration. Note: If you move your unit to another system the calibration and correction will function as it did for your last calibration but the info pane will show no data as the system data is stored on the host computer.

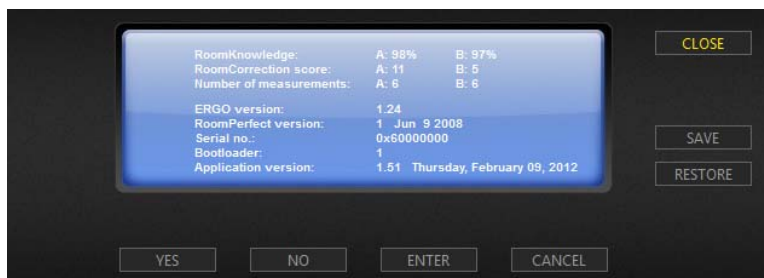

In the window you will see the following:

- Room Knowledge:** This is a % value based on how much ERGO “learned” about you room
- Room Correction Index:** This is a score (up to 30) which indicates how complex the correction was
- Number of Measurements:** This is the number of calibration measurements you took.
- ERGO Version:** This is ERGO’s firmware version (currently 1.23) check [www.krksys.com](http://www.krksys.com) for the latest firmware for your unit.
- RoomPerfect Version:** This is the version of the RoomPerfect algorithm in use (the latest is 2008)
- Bootloader:** This is the bootloader number and should be “1”
- Application Version:** This is the version of the ERGO Cal application (currently 1.20) check [www.krksys.com](http://www.krksys.com) for the latest software for your unit.

Note: if you have a new ERGO which has not been calibrated there is no information in the first three fields. You can now close this window and return to ERGO Cal’s main window by pressing “Close”

5. ERGO Cal will now search for ERGO and begin communicating, once complete you will see the message below, please press ENTER to begin the process. **Note:** You can cancel the calibration process at any time, if you are interrupted or want to start again simply press cancel and return to the start of the procedure.

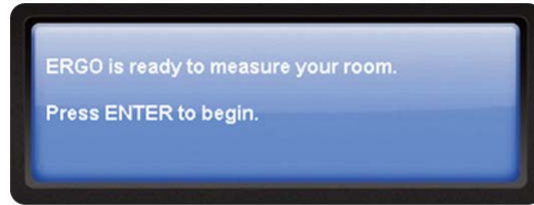

6. The next step will remind you to check connections, at this point your monitoring system should be on and the volume should have been set to your normal monitoring level, or by following the chapter called “Setting Monitor and Subwoofer Levels”.

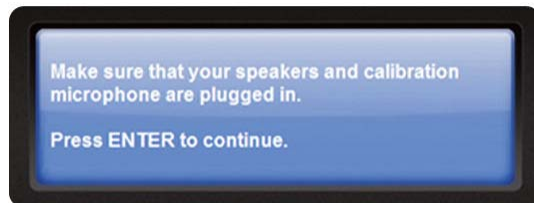

7. You will then be asked if you are using ERGO in subwoofer (2.1) mode, your answer will determine how ERGO’s A and B switches operate. If you select “No”, the A/B switches will alternate between the A and B monitors. If you select “Yes” Switch A will control your main monitors, and switch B will control the subwoofer.

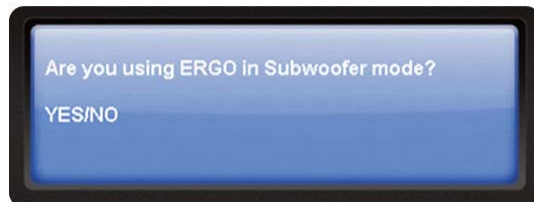

8. The next window may inform you of which, if any, buttons are selected on ERGO—A, B/Sub, both, or neither and will instruct you to select the appropriate button. Note: Ensure you have selected the monitor path for the monitors you wish to calibrate. You will receive confirmation as shown below (differing messages for each choice – Measurement A shown). Press ENTER to continue.

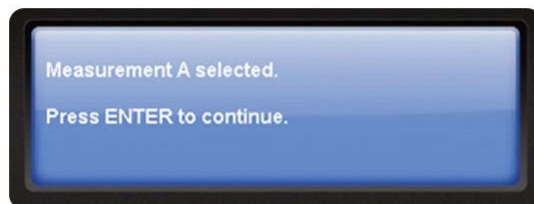



9. If you chose to use ERGO in Subwoofer mode, the next window may tell you to press any of ERGO's required buttons, please follow the guidance. When given the prompt below confirming both buttons are on press ENTER to continue

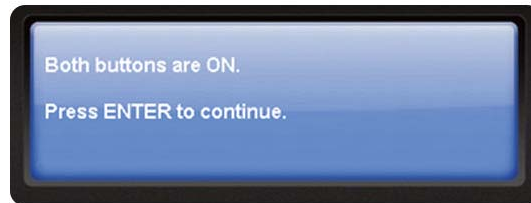

10. In order to create new calibration data ERGO must first overwrite the existing measurement. The screen will look as shown below (differing messages for each choice – Measurement A shown). Press ENTER to continue.



11. After a few seconds you will see the following message, please wait while the measurement memory is cleared.



12. The step will check the position of the calibration button, as this routes the signal from ERGO's measurement microphone into the hardware. If the calibration button is OFF you will be asked to turn it on, for the position please refer to the rear panel diagram at the front of this manual. You will then see the following message, press ENTER to continue.

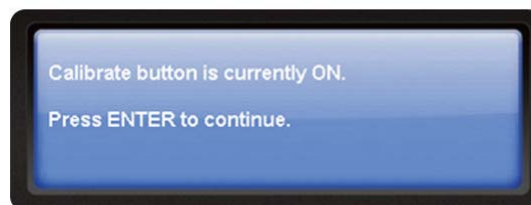

- You will then see the following message informing you to set the volume knob to the 12 o'clock (or North) position. This is a necessary step in order to set the position of the volume knob for the first calibration tones, so that they are at a safe low level. Position the volume knob and press ENTER to continue

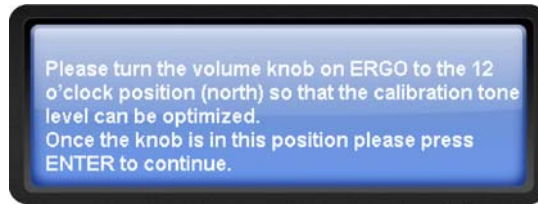

- You will be asked to slowly adjust the knob until the volume is in the correct position, please follow the instructions on screen until you receive the message below, and then press ENTER to continue.

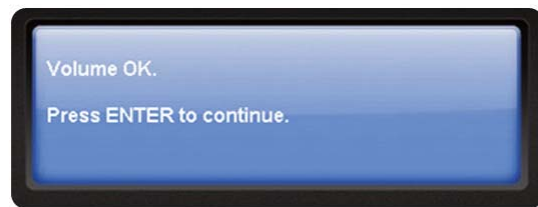

- You will then be asked to place the measurement microphone in the FOCUS position. This is the sweet spot of your monitoring system. Make sure that the height and orientation of the microphone correspond to your typical listening height and direction as illustrated below. Do not block the line of sight between the microphone and the loudspeakers. Each measurement is comprised of a low and a high frequency measuring signal first in the left and then in the right channel.

The length of each measurement depends on a combination of the measurement volume, and the background noise in your local environment. Typical measuring times for the low and high frequency measuring signals are 25 and 5 seconds, respectively. If an error message is displayed. Make any required corrections to your set up and follow the prompt to retry the measurement.

Focus Position Measurements must be performed more than 1 m (3 ft) away from the loudspeakers, in an X/Y orientation, and must not be performed behind the loudspeaker. Also, do not sit in the listening position while Focus measurements are being taken.

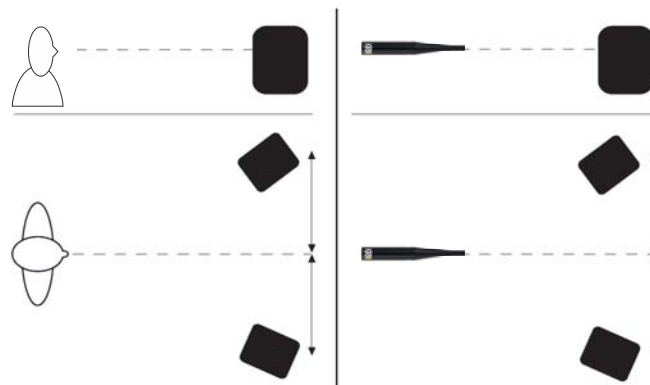

16. Once you have the measurement microphone in the FOCUS position please press ENTER to continue as shown below:

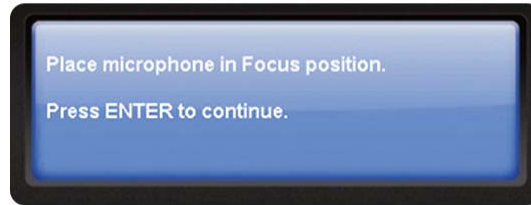

17. Next the volume level calibration message will appear, and you will hear a test tone. **Note:** You will only hear the test tone in the LEFT monitor, as each side is measured independently.

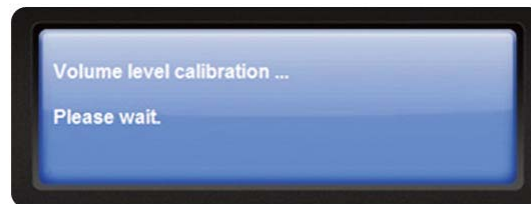

18. If the volume needs adjusting ERGO Cal will ask you to adjust the level, please follow the messages until you see the screen below and press ENTER to continue. Note: If you cannot get enough level from your monitors, press "No" to accept your maximum level and ERGO will still be able to perform calibration, although the results may be affected by the power output of your system.

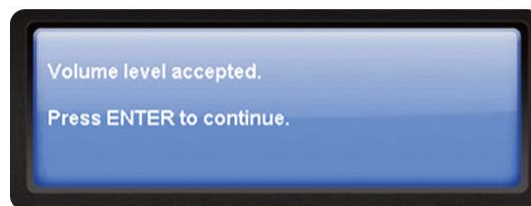

19. ERGO will then commence measuring your system, you will hear two measurement test signals being played through the left monitor, then the right monitor. While the room is being measured you will see this message:



20. Once the FOCUS position has been measured, you will see the screen below.

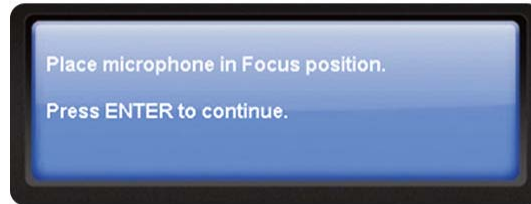

21. Next the volume level calibration message will appear, and you will hear a test tone. **Note:** You will only hear the test tone in the LEFT monitor, as each side is measured independently.

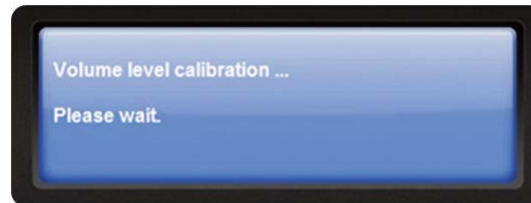

22. If the volume needs adjusting ERGO Cal will ask you to adjust the level, please follow the messages until you see the screen below and press ENTER to continue. Note: If you cannot get enough level from your monitors, press "No" to accept your maximum level and ERGO will still be able to perform calibration, although the results may be affected by the power output of your system.

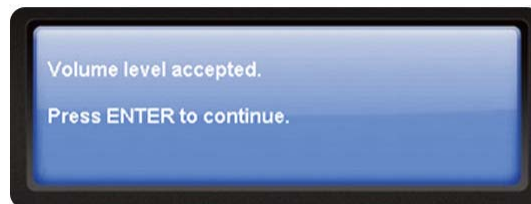

23. ERGO will then commence measuring your system, you will hear two measurement test signals being played through the left monitor, then the right monitor. While the room is being measured you will see this message:



24. Once the FOCUS position has been measured, you will see the screen below. If there was a problem with the measurement (such as a transient was detected), please follow the instructions to repeat the measurement. Until you see this screen then STOP and read the next section before moving on.

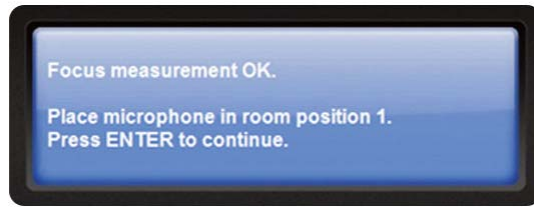

25. Next, ERGO Cal will measure the other positions in the room. The number of room positions needed depends on the value of Room Knowledge. If it is below 90% after the third measurement, ERGO Cal automatically includes extra room measurements until a Room Knowledge of 90% or better has been achieved. The remaining measurements should be taken from random positions in the room with random orientations of the microphone. Choosing these positions (possibly other listening seats, or a couch in the control room) or places many people would stand if they are in the room (you can even try finding problem spots in the room and taking an additional measurement there. All you have to do is place the microphone at different positions in the room and in different orientations. It is important to perform well-spaced measurements to get a covering image of the acoustical properties in the room that is varying positions, heights, and orientations of the microphone.

For optimal room correction, make sure that the measurements are:

1. Performed more than 1 m (3 ft) away from the loudspeakers
2. Not performed behind the loudspeaker
3. Taken at a minimum of 50 cm (1.5 ft) between each measurement

The following illustration shows the steps listed above:

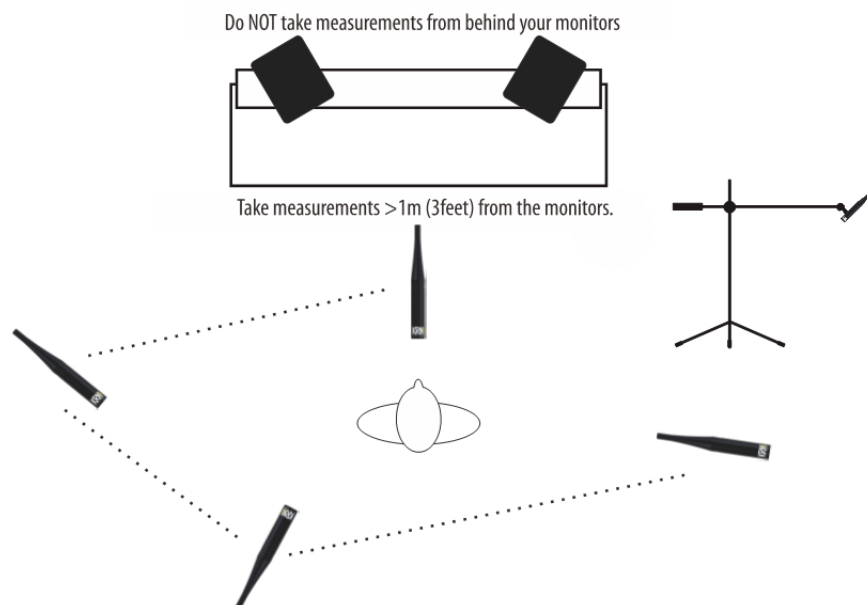

26. Place the microphone in your first position and press ENTER to continue. ERGO will then analyze that position and then ask you to re-position the microphone to the next position. Follow the process until you have at least 90% room knowledge.

The room correction score is a measure of how much processing is being performed in the room correction filters. To some extent, this reflects how audible the correction is. However, the same amount of processing can sound very different due to placement in frequency of the processing. For low values (below 10%) of the room correction score, only subtle correction is needed to the original sound in the room. With high room correction scores, more extensive processing is employed. The room correction score for a specific RoomPerfect™ filter can be viewed by pressing the Info button from the initial (ERGO is ready to measure your room) screen.

As ERGO begins taking measurements to acquire Room Knowledge, you will be notified of the percentage of information gathered after each measurement, and instructed to continue on to the next Room position measurement.

If you choose to continue with more measurements, select YES and follow ERGO's prompts until you want to stop. Some rooms take many measurements; some can reach this level with only 3 measurements. ERGO will not let you store a room correction until Room Knowledge is at least 90%. You may continue taking additional measurements to increase Room Knowledge, which will result in a more accurate correction filter.

After the final measurement you will see the following screen, please press YES to store the measurement into ERGO.

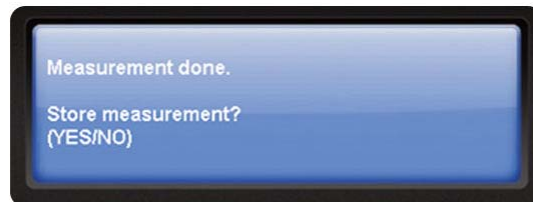

27. When sufficient Room Knowledge has been obtained, target curves, focus filters (listening position) and global filters (general room filter) are generated automatically and stored in ERGO. You will see the following message while this is done



28. The next screen will ask you to release the calibration button on the rear of ERGO, please do so.

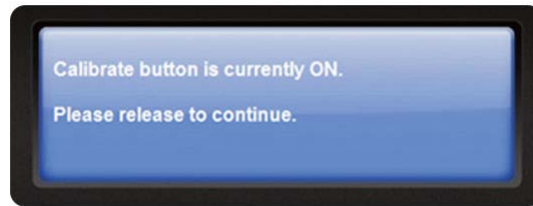

29. You will finally see the congratulations message below, informing you that your room acoustic response is now optimized by ERGO

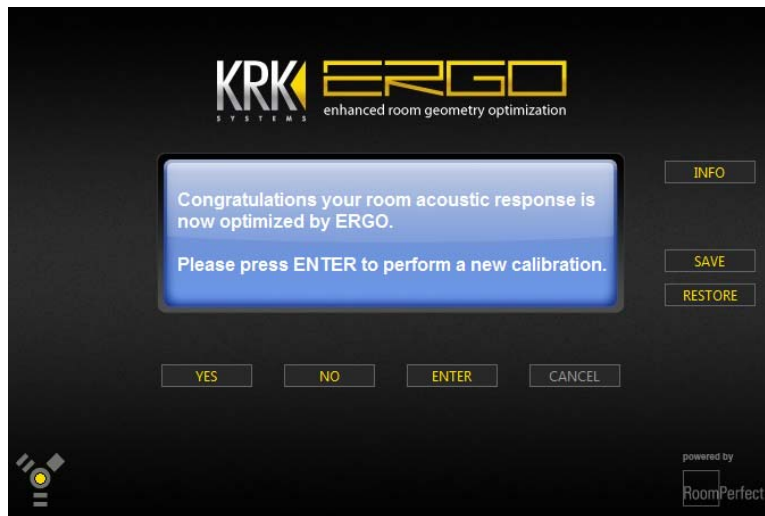

30. You may now quit ERGO Cal and begin using ERGO following the guide in the next section. If you have another set of monitors connected and ready to calibrate simply press enter and the procedure will re-start. If you wish to store your measurement data simply press the "SAVE" button and navigate to a suitable location to store your data.

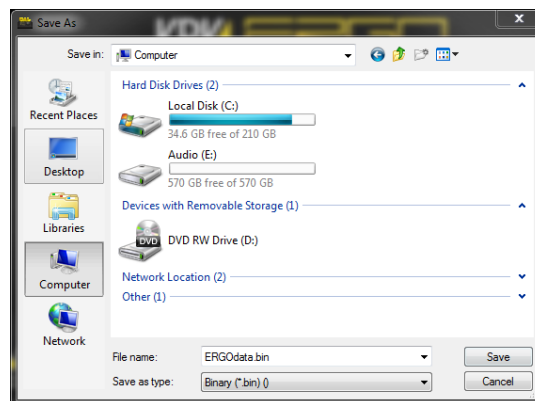

To restore a previous room calibration simply start ERGOcal and press "RESTORE" then select the .bin file you previously saved. **NOTE: ROOM CALIBRATION SAVE AND RESTORE IS A COMPLEX PROCESS AND TAKES AROUND 10MINS TO COMPLETE.**

## 26. ERGO Control Panel (Windows / Mac OSX)

Once ERGO is installed and calibrated it will be ready for use with any audio application or operating system which is currently supported.

The control panel to access specific settings can be found in you "Programs" folder and the icon looks like this:



ERGO Control Panel

To start the control panel, double-click the icon with your left mouse button: 

The control panel will start and you will see this window, this chapter will take you through the elements of the control panel before you begin using ERGO with your DAW.

**Note for Apple Mac OSX users:** You will not see a buffer settings size; this is all handled by the integrated CoreAudio driver for Leopard and Snow Leopard.



### A. ERGO Info

This is a read-only display that indicates the current "System Firmware" revision, "DSP firmware" revision, and the FireWire ID.





## B. Speaker Mode

Allows you to select to use dual “STEREO A/B” or “2.1 A+B(SUB)” id using a system augmented with a subwoofer. Note: If in “STEREO A/B” mode no crossover fader or value will be shown



If selecting 2.1 Mode, as shown below, a fader will appear along with a value for the crossover frequency. Use the fader to adjust your crossover settings, please see the section on setting levels, or your systems guidance for subwoofer crossover frequencies. Remember that in a speaker crossover network, the crossover frequency is the frequency point that represents the upper or lower range limits of a given speaker driver. In a two-way speaker system, the crossover frequency would be the point where the low frequency driver begins to roll off and the high frequency driver starts to cut in.



## C. Headphone Source

The headphone output can be selected from two options:

1. The headphones follow the main output 1-2 (normal mixing mode for engineer),
2. The headphones become an independent output 3-4 (allowing a dedicated monitoring feed for an artist).

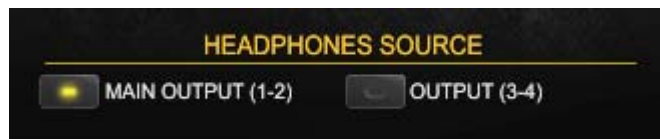

#### D. Input Select

**Note:** Input select requires revision 1.23 (or higher) firmware, please ensure you have this firmware in your unit, if not please go to [www.krksys.com](http://www.krksys.com) and download the firmware updater from the ERGO page.

Input select allows you to switch the input source for “KRK ERGO Inputs” which will be visible in your audio applications and operating system.

**AUTO** – In this mode, ERGO will route the analog signal to the inputs, unless a digital signal is detected. If a digital signal is detected it is automatically selected, and will replace the analog input.

**S/PDIF** – In this mode the digital signal is will always be routed to the inputs.

**ANALOG** – In this mode the analog signal is will always be routed to the inputs.



**Note:** In S/PDIF mode you will see the incoming digital audio stream status in the window shown below:



The simulated LED's will illuminate to show:

**LOCK** – ERGO has detected and locked the signal at the S/PDIF Input socket.

**PRO** – Professional Mode S/PDIF signal is present

**ANALOG** – Consumer Mode S/PDIF signal is present.

**Note:** If you are in Standalone mode (no FireWire connected) and ERGO detects a SPDIF clock; it automatically selects the SPDIF Input as its source. If ERGO has detected a SPDIF clock, but the SPDIF Input is not working, then ERGO was started in Analog mode. Use the ERGO Control Panel to select the SPDIF Input. If the SPDIF Input is not working, ERGO is probably not locking its clock to a SPDIF clock. Check your cables and the audio output selection in your DAW application.

## E. Audio Settings

This display lights to indicate ERGO's sample rate. Use the associated pull down boxes to select ERGO's sample rate and ASIO buffer size. Reducing the buffer size can decrease the amount of latency while monitoring and recording audio. Increasing the buffer size can reduce and /or eliminate some audio artifacts such as pops and clicks while recording.

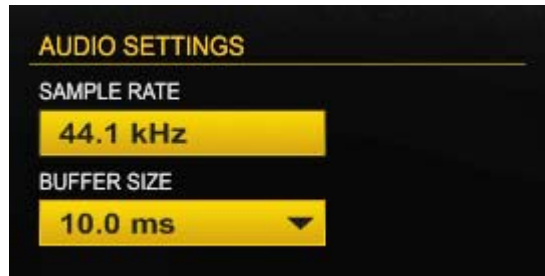

**Note for Apple Mac OSX users:** You will not see a buffer settings size; this is all handled by the integrated CoreAudio driver for Leopard and Snow Leopard.

Use the associated pull down boxes to select ERGO's sample rate and buffer size.

Reducing the buffer size can decrease the amount of latency while monitoring and recording audio. Increasing the buffer size can reduce and /or eliminate some audio artifacts such as pops and clicks while recording.

To obtain more information about buffer size settings, please refer to your DAW's User's Manual (especially the chapters related to Hardware/Software configuration, Audio Drivers' selection, etc.

## F. Further Use

Please refer to the audio guides for your Windows or Mac OSX operating system or audio application in order to get the best out of your ERGO system.

Windows users will see the supported driver categories such as Direct X, Wave and ASIO in the audio application and can control Windows use of ERGO in the "Sounds (and Audio Devices)" page of the Windows control panel.

Mac OSX user will see the CoreAudio device in the "Audio/MIDI Settings" panel, and in the "Sound" section of your "System Preferences"

For specific set-up guides for your Digital Audio Workstation, please go to [www.krksys.com](http://www.krksys.com).



## 27. Specifications

<b>Processing</b>	400MHz Analog Devices Blackfin® DSP
<b>RoomPerfect Algorithm Sample Rate</b>	96KHz
<b>Room Correction Frequencies</b>	20-500Hz
<b>Room correction Filter</b>	1024 tap Finite Impulse Response
<b>S/PDIF Input Operating Range</b>	44.1 kHz to 96 kHz
<b>S/PDIF conformity</b>	IEC60958-3
<b>Dynamic Range</b>	96 dB system (component 118dB)
<b>System THD+N</b>	<0.025% using 0 dBFS input and 22-22kHz Band Pass Filter
<b>Internal Sample Rates</b>	44.1 kHz, 48 kHz, 88.2 kHz, 96 kHz
<b>Maximum Microphone Input Level</b>	-32 dBu
<b>Maximum Line input Level</b>	+19 dBu
<b>Maximum Line Output Level</b>	+19 dBu
<b>Firewire Implementation</b>	Dual 1394a (Firewire400) ports
<b>Dimensions:</b>	180mm (7") x 55mm (2.2") x 107mm (4.2")
<b>Microphone Length:</b>	197mm (7.75")
<b>Weight:</b>	610g (21.5 oz)
<b>Power:</b>	1394 Bus or External 12v
<b>Operating Temperature Range:</b>	40° F (4° C) to 110° F (43° C)

## 28. Frequently Asked Questions (FAQs)

### **What is ERGO?**

ERGO is an audio interface with built in digital room analysis and correction system. It consists of the ERGO unit, a measurement microphone and control software. These three pieces are used to measure and analyze phase and frequency problems within a listening environment and then a powerful digital signal processor in the ERGO hardware unit processes audio to correct for these problems.

### **How does Room Correction help?**

ERGO's licensed RoomPerfect room correction technology can help you make better, more informed decisions about your mix. If you find your mixes do not translate well from your studio to other listening environments it is most likely that your room is the problem. ERGO corrects for the audio coloration in your room and this, in turn, allows mixes to translate better to numerous listening environments. If your room has problems, better speakers will not resolve the problem, and while we endorse the acoustic treatment of your room quite often there are limitations of what can be expensive and time consuming. With ERGO even if some large elements in the room change, it's as simple as re-calibrating to perform the optimal correction.

### **Do I need a computer to use ERGO?**

ERGO only requires a FireWire connection to a computer in order to run the analysis portion of the room correction process. Once the analysis is complete, ERGO no longer needs to be connected to the computer, you can simply connect your digital or analog input and your monitors. If any large structures in the room change we always advise spending 15-20 minutes re-calibrating using ERGOcal.

### **What is the difference between ERGO and "room correction" software built into operating systems like Microsoft Windows 7, or Apple Mac OSX Snow Leopard?**

First and foremost are the DSP requirements to perform accurate room correction, while simple filters can be created and inverted to compensate for single bands of error, RoomPerfect offers much higher analysis and correction than a "built-in" system such as these. Room correction relies heavily upon the accuracy of the measurement and the analysis of this data to create an acceptable correction that does not distort or color the sound. To do this, variables in measurement, analysis and correction need to be reduced or eliminated. Because ERGO is a complete system with matched equipment and measurement techniques this removes a lot of variability and the result is improved correction. Operating system-based correction introduces a number of variables that result in inaccurate measurement. Also operating system based correction can take an alarming % of your system resources. This means fewer plugins, increased latency and overall poorer system performance when working in your chosen DAW. ERGO does not place any processing load on the CPU when performing its room correction.

### **Can ERGO work with my existing computer audio interface?**

Yes, ERGO simply patches between the main Left/Right analog outputs of your existing audio interface, or will take an S/PDIF format digital output from your existing audio interface or hardware. This is a very simple and easy method to work with ERGO since there is no reconfiguring of your audio workstation or drivers.

### **Can ERGO work with AVID/Digidesign Protools?**

Yes, simply patch ERGO between the main Left/Right analog outputs of your Protocols interface or will connect to the S/PDIF outputs of your Protocols rig. Assign your "main" outputs in Protocols to your chosen method (digital or analog) , and ERGO will apply correction before the signal from your audio interface reaches your monitors.

### **Can ERGO work with any powered or passive monitors?**

Yes, ERGO is designed for active monitors but will work with passive monitors as well. When using passive monitors make sure the amplifier has any equalization or filtering disabled.

**Can ERGO work with two sets of speakers?**

Yes, ERGO can switch between A and B speakers via its front-panel controls. Each set of speakers will need to be calibrated and will have their own correction filters so that when you are comparing or “A/B’ing” a mix, the specific correction for the selected monitors is engaged.

**Can ERGO work in a 2.1 system?**

Yes, ERGO will work with and correct 2.1 systems. It will treat the subwoofer as part of the monolithic speaker system.

**Can ERGO work in a 5.1 system? Can I use 2 or more ERGOs for this?**

No, ERGO is designed for Stereo or 2.1 (Stereo augmented by subwoofer) only.

**Is there a way to bypass the Digital to Analog converters on ERGO so I can use another D/A converter?**

No, ERGO uses phase accurate FIR filters in both, the correction algorithm and the D/A converters. FIR filters, unlike IIR filters found in some D/A converters, do not exhibit frequency dependent phase shifts. Since ERGO corrects in both time (phase) and frequency domains, it is imperative that we know the characteristics of the D/A converter and do not induce unwanted or variable phase distortions. Hence the reason behind ERGO’s architecture.

**Does ERGO color/change the character of my monitors?**

No, ERGO only corrects it for presentation in your listening space, just as the character of your mix would change if your environment was acoustically treated. ERGO performs a similar job, but in the digital domain.

**What do the different LEDs on the Focus/Global button indicate?**

When the button is illuminated ERGO is in Focus mode

When the button is not illuminated ERGO is in Global mode

When you hold the button down for 1 sec ERGO is bypassed, and the LED will flash indicating correction is not used.

**Does ERGO use analog or digital volume control?**

ERGO uses a digitally controlled analog volume control. This means that the signal to noise ratio of ERGO is constant throughout the volume setting. This is an expensive method which is far superior to systems that use digital volume control, since digital volume adjustments actually reduce the signal to noise ratio of the system at lower volumes. ERGO is true and clear throughout its volume range. The Left to Right matching or balance is also much better than a traditional analog potentiometer.

**Does ERGO need external power?**

No. If you have a 6-pin or 9-pin Firewire connection ERGO can draw its power directly from the FireWire interface. If using ERGO in “stand-alone” mode you connect the external power supply provided.

**Why does ERGO room correction only affect frequencies below 500Hz?**

90% of the main acoustic problems in studio control rooms occur in frequencies below 500Hz. ERGO’s use of RoomPerfect is designed to specifically correct this area of the freq. spectrum. To fix the remaining 10%, or problems above 500Hz, requires significantly more processing power because of the timing requirements of processing higher frequency components.

**Does ERGO work during tracking, or only during mix down?**

ERGO’s room correction should be bypassed during tracking. As with all audio interfaces and processing should be disabled, this results in the lowest latency when monitoring your performance. After the track is recorded, room correction can be enabled again.

## 29. Troubleshooting

### **ERGO does not turn on.**

Ensure you have power connected and ERGO is turned on using the power switch on the rear of the unit. Remember the power can be provided using the supplied power adaptor or from a Firewire port (must be 6-pin or 9-pin) Most likely you are using a 4 pin (mini) FireWire port. These FW ports are commonly found on PC laptops. You need a standard 6 pin FW port in order to power ERGO. The 2 pins that are missing are the pins that carry power. The FireWire port is not supplying enough power for ERGO (can be caused by having multiple Firewire devices connected). Use the 12VDC power adapter to power up ERGO, and of course check the wall socket is operational.

### **You do not have, or cannot find the driver for ERGO.**

Please download the latest drivers for your operating system from [www.krksys.com](http://www.krksys.com).

### **Your computer does not have a 6 pin FireWire port on it.**

If you have a 9-pin port you will need to purchase a 9-pin to 6-pin cable in order to use with ERGO. Please ensure you buy a high quality cable from a well known brand as these are usually built to the 1394 specification and are more reliable than cheap alternatives.

### **Your computer doesn't have a FireWire adapter at all.**

In most cases, a FireWire interface can be easily added to a computer. For laptops, you need to look for either a PCMCIA or ExpressCard based adapter (which one to use depends on the card slot your computer is equipped with). For desktops, you should use an add-in PCI FireWire card. Please do *not* use a USB-to-FireWire adapter cable because it will severely degrade performance. Also avoid cards with multiple interface types as this can also affect performance.

### **You are experiencing noise in audio recordings / playback.**

This can be many things. Do you hear noise even when there's no software playback? If so, then the cause is likely a ground loop (especially if it goes away when running the computer on battery power). Please consult a qualified electrician if you believe you have grounding issues.

### **You are experiencing click and pops in audio recordings / playback.**

Does increasing the buffering in the driver make the problem go away? If so, then it could be an issue with your system performance. For guidance in optimizing your computer to playback audio reliably, please read the specific guides found on the CD or available from [www.krksys.com](http://www.krksys.com).

Support of 1394 under Windows is a complex issue and there are many hotfix downloads which Microsoft offer for the various 1394 solutions depending on the manufacturer of the Firewire chipset used on your computer. If you are experiencing problems with streaming audio, or connectivity issues you search the Microsoft Support database for any "1394 hotfix" downloads for your operating system. The OHCI driver for your device may also affect performance, for more information see the specific guides found on the CD or available from [www.krksys.com](http://www.krksys.com)

### **Using ERGO in WDM modem you cannot set a buffer size value in the Control Panel**

This is normal operation, to manually select buffer size you must use ASIO drivers.

### **The Calibration Microphone cannot detect a loud enough level**

Turn up the level on your monitoring system; it needs to excite your room in order for ERGO to measure it accurately.

This should not happen on Macs, since the Mac OS can aggregate, or combine, multiple devices into a single interface.

Windows users have a couple of options:

Windows systems can only have a single ASIO device.

Use your main ASIO device when tracking, and switch to ERGO ASIO when mixing down.

Take a SPDIF or analog out from your existing FireWire interface and plug it into ERGO. In this mode, you can unplug ERGO from its FireWire port and power up using the external power adapter. ERGO's S/PDIF Inputs and converters are of the highest quality, so there will be no degradation when using this approach. In fact, if your DAW is already optimized, we suggest that you use this approach.

### **An elderly computer does not detect ERGO**

ERGO needs Leopard (10.5.x) or Snow Leopard (10.6.6)

### **The Calibration Microphone appears not to be working**

You need to have the Calibrate switch on the back of ERGO pushed in order for the microphone to work. Make sure the Calibrate LED on the Front Panel is illuminated. Use only the KRK measurement microphone! Don't plug in any other microphone in for calibration. If you lose your KRK measurement microphone, you can buy a new one from KRK customer support at (954) 949-9600.

### **You cannot differentiate between ERGO in bypass and processing modes.**

Your room may already be very good, so ERGO is only optimizing smaller nodes and room problems. This is very unlikely, however. ERGO's effects can range from subtle to extreme, so there should be a difference. In particular, listen for the following:

- Improved imaging
- Tighter bass
- More definition among instruments

### **RoomKnowledge will not reach 100%**

The complexities of any room and the way room knowledge is calculated means that 100% can rarely be reached. After 9 measurements the system will have reached the maximum knowledge ERGO can achieve.



## 30. Glossary

### **A-D Convertor**

The conversion of analog data or information into digital or binary form (See binary).

### **ASIO**

Audio Stream Input Output. ASIO, developed by Steinberg, is a cross-platform, multi-channel audio transfer protocol. It allows software to have access to the multi-channel capabilities of a wide range of powerful sound cards.

### **Binary**

A digital numbering system based on two where data is expressed as combinations of "0"s and "1"s). Bit - A single unit of digital information expressed as a "0" or "1."

### **CoreAudio**

This is an ultra-low latency, high quality MAC-compatible audio driver that is built directly in to the OS X operating system.

### **Decibel (dB)**

A unit of measurement for expressing sound pressure level (SPL), signal level and variation or differences in signal level.

### **D-A Convertor**

A circuit used to change digital data into analog voltage levels that approximate the original analog audio waveform.

### **DSP**

An abbreviation for Digital Signal Processing (Any signal processing done after an analog audio signal has been converted into digital audio.

### **Dynamic Range**

The level difference expressed in dB, between the loudest level and quietest level of a recording or live audio source.

### **Filter**

A circuit that removes or acts on certain frequency signals above or below a predetermined point called a cut-off frequency.

### **Frequency**

The rate or speed at which an audio source generates, measured in complete cycles per second. The number of cycles that occur in one second is call hertz (Hz).

### **Frequency Range**

The range of frequencies a device is capable of accurately reproducing.

### **Frequency Response**

A plot or graph of frequencies that an audio device, such as a microphone, amplifier or speaker, can accurately reproduce within stated parameters or conditions.

### **Harmonics**

A tone mixed with whole-number multiples of the fundamental tone that distinguish the pitch of a particular instrument or sound.

### **Harmonic Distortion**

The occurrence of harmonics within the output signal which are not present in the original input signal.

### **Hertz (Hz) / KiloHertz (kHz)**

A unit of frequency measurement used to express the number of complete cycles occurring in a one-second interval.

### **Impulse Response**

A lot of information about a device can be determined by how it reacts to a particular impulse. Impulse response could be defined as a measure of the time domain response of a system, input-to-output, to a very brief transient signal at its input. The Fourier transform of this time-domain waveform is the frequency-domain transfer function. So frequency, phase, and transient responses are all related to this concept. In fact, the reverberation of a room can be thought of as its impulse response.

### **I/O**

Input/Output – A connection for channeling the flow of audio or signal data to and from a device.

### **Room Correction Score**

A measure of how much processing is being performed in the room correction filters. The room correction score for a specific RoomPerfect™ filter can be viewed by pressing the Info button from the initial (ERGO is ready to measure your room) screen.

### **RoomKnowledge**

Indicates how much information has been gathered about the room. See more details earlier in this manual.

### **Sampling Frequency**

The number of analog audio signal samples taken in one second to produce a digital interpretation of the original signal. The industry standard sampling frequency for CD-quality audio is 44.1 kHz, also referred to as "Sample Rate".

### **THD**

Total Harmonic Distortion is defined as the ratio of the sum of the powers of all harmonic components to the power of the fundamental frequency.

### **Windows Driver Model**

A driver model based on the Windows NT driver model that is designed to provide a common architecture of I/O services for Windows operating systems for specific classes of drivers. This driver model is currently supported under Windows 98 Second Edition, Windows Millennium Edition, Windows 2000, and Windows XP. WDM drivers provide multichannel I/O.

## 31. Further Assistance:

We hope that this help document gives you all the information you need to get up and running. If you have any additional questions, please feel free contact our Customer Support Monday through Friday at +1 954.9499600 from 9AM to 6PM EST.

Please have the serial number for your unit ready (located on the base of the unit).

## 32. LEGAL

Specifications subject to change for improvement purposes without notice or obligation

Apple, OSX Snow Leopard and Mac OS are trademarks of Apple, Inc., registered in the United States and other countries.

Microsoft, Windows 7 and Windows Vista are registered trademarks of Microsoft Corporation in the United States and other countries.

FireWire and the FireWire symbol are trademarks of Apple Computer, Inc., registered in the U.S. and other countries.

The FireWire logo is a trademark of Apple Computer, Inc.

Blackfin is a registered trademark of Analog Devices, Inc. All other trademarks included herein are the property of their respective owners.

RoomPerfect is a registered trademark and the RoomPerfect logo is a trademark of Lyngdorf Audio A/S.

Digidesign and ProTools are registered trademarks of Avid Technology, Inc in the United States and other countries.