

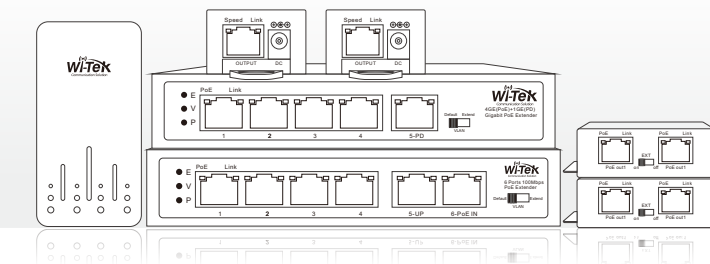

## Wi-Tek PoE Extender



IEEE802.3af and IEEE802.3at  
WI-PE31E/WI-PE51E/WI-PE31G/  
WI-PE51G/WI-PE41E-O

### 1. Package Content

#### 1.1 WI-PE31G as an example

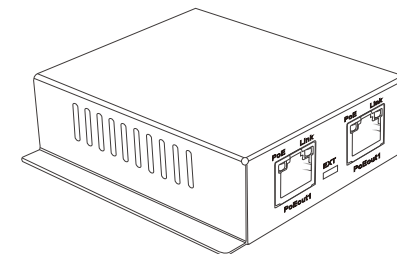

PoE Extender X1

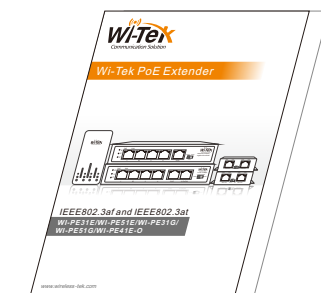

Guide Book X1

### 2. Hardware Overview

#### 2.1 Indoor PoE Extender (WI-PE31 E / WI-PE31G)

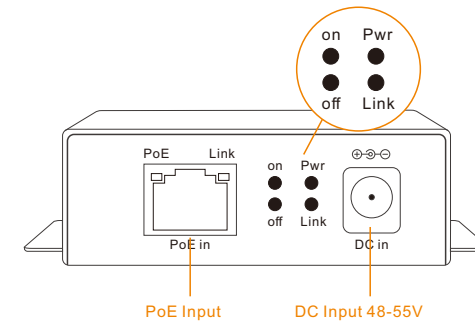

Extend DIP Switch  
on: The transmission of PoE output ports can be up to 250m, but the rate is limited to 10Mbps  
off: The transmission PoE output ports can be up to 100m with 100Mbps

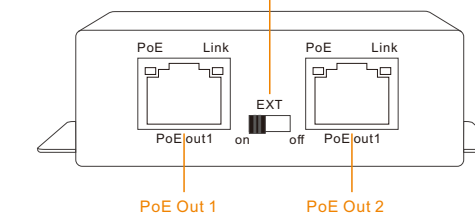

LED Indicators	
PWR (Power indicator)	Off: the device is power off or failed On: the device power on is normal
Link Indicator	Off: ports link down On: ports link up Blinking: data on TX/RX
PoE Indicator	Off: PoE not working On: PoE working
VLAN	Off: VLAN mode is disable. On: VLAN mode is enable.
Extend	Off: Extend mode is disable On: Extend mode is enable

#### 2.2 Indoor PoE Extender (Take WI-PE51G as an example)

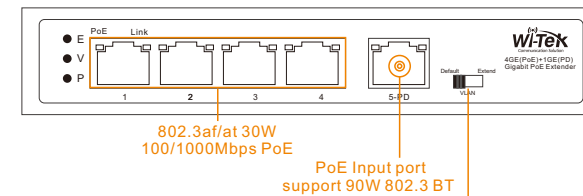

Default: The transmission PoE output ports can be up to 100m with 100Mbps  
Extend: The transmission of PoE output ports can be up to 250m, but the rate is limited to 10Mbps.  
VLAN: All downlink ports are isolated from each other, but can communicate with uplink ports.

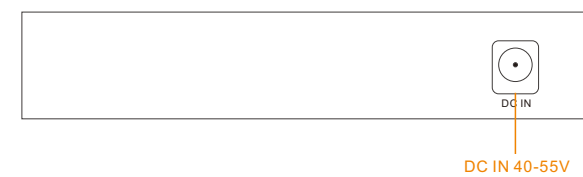

LED Indicators	
PWR (Power indicator)	Off: the device is power off or failed On: the device power on is normal
Link Indicator	Off: ports link down On: ports link up Blinking: data on TX/RX
PoE Indicator	Off: PoE not working On: PoE working
VLAN	Off: VLAN mode is disable. On: VLAN mode is enable.
Extend	Off: Extend mode is disable On: Extend mode is enable

#### 2.3 Outdoor PoE Extender

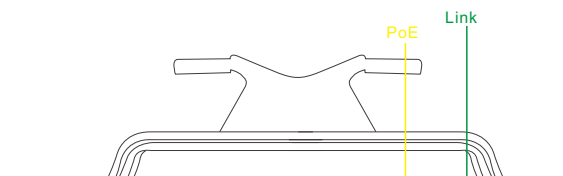
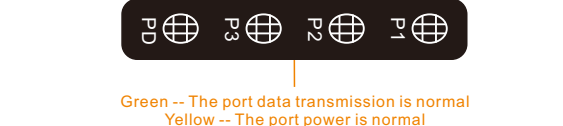

LED Indicators	
Link Indicator	Off: ports link down On: ports link up Blinking: data on TX/RX
PoE Indicator	Off: PoE not working On: PoE working
P1/P2/P3/PD	Green: data on TX/RX Yellow: the PoE is normal

### 3. Network Application

#### 3.1 Networking Solution (Illustration for WI-PE31E)

Step 1: Connect the first PoE extender to the PoE port of switch which is compatible with 802.3af/at/bt.(Or connect a DC adapter to power up the first PoE extender)

Step 2: Connect the second PoE extender to the first PoE extender via PoE input port.

Step 3: Connect an IP camera to the second PoE extender via PoE output port.

Note: Recommend no more than 4 units PoE extender in one network.

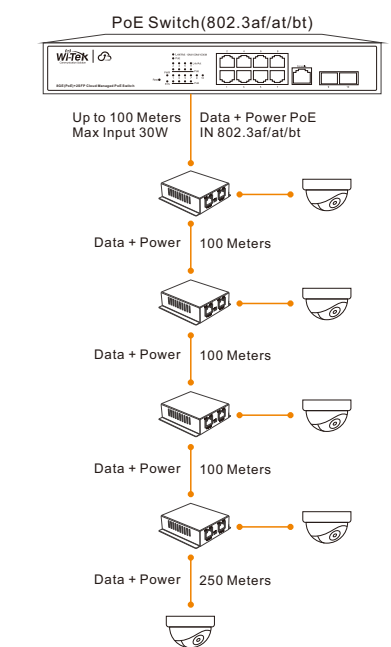

### 4. Product Family

Product	Speed	Interface	PoE Output Port	PoE Input Port	Application
WI-PE31E	100Mbps	3FE	2 x 802.3af/at 30W	1 x 802.3af/at 30W	Indoor
WI-PE31G	1000Mbps	3GE	2 x 802.3af/at 30W	1 x 802.3af/at 30W	Indoor
WI-PE51E	100Mbps	6FE	4 x 802.3af/at	1 x 60W Hi-PoE	Indoor
WI-PE51G	1000Mbps	5GE	4 x 802.3af/at 30W	1 x 60W Hi-PoE	Indoor
WI-PE41E-O	100Mbps	4FE	3 x 802.3af/at 30W	1 x 60W Hi-PoE	Outdoor
WI-PE21E	100Mbps	2FE	1 x 802.3af/at 30W	1 x 802.3af/at 30W	Indoor
WI-PE21G	1000Mbps	2GE	1 x 802.3af/at 30W	1 x 802.3af/at 30W	Indoor

### Warranty Card

Username	
Address	
Telephone No.	
Purchase Shop	
Purchase Address	
Product Model No.	
Purchase Time	
Serial No.	
Dealer Signature	

- If the product defects within three months after purchase, we will provide you a new product of the same model.
- If the product defects within the three-year warranty period, we will provide the professional maintenance service.
- Proof of purchase and a complete product serial number are required to receive any services guaranteed as part of the limited warranty.
- Any other defects that are not caused by workmanship or product quality, such as natural disaster, water damage, extreme thermal or environmental conditions, sticker damaged, warranty card losing will disqualify the product from limited warranty.



Wireless-Tek Technology Limited  
Address: Biaofang Technology Building 402, Bao'an street,  
Baoan District, Shenzhen City, Guangdong, China  
Website: www.wireless-tek.com  
Tel: 86-0755-32811290  
Email: sales@wireless-tek.com  
Technical Support: tech@wireless-tek.com