



**UR FOG**  
SECURITY FOGGING SYSTEMS

## INSTALLATION AND USE MANUAL



**BAT 300**  
TEMPEST TECHNOLOGY

ENGLISH MANUAL

Installation manual vers.1.0 (FW 1.1.3)

# SUMMARY

<b>1</b>	Introduction	page 3
<b>2</b>	Conditions of use and safety requirements	page 3
<b>3</b>	Mobile applications	page 4
<b>4</b>	Package contents	page 4
<b>5</b>	Technical data	page 4
<b>5.1</b>	Physical features (Table A)	page 4
<b>5.2</b>	Electrical characteristics, consumption and heating time (Table B)	page 4
<b>5.3</b>	Performance (Table C)	page 5
<b>6</b>	Positioning and installation	page 5
<b>7</b>	Cable passages	page 7
<b>8</b>	Electronic board	page 7
<b>8.1</b>	General view	page 7
<b>8.2</b>	Description of the parts (Table D)	page 8
<b>9</b>	Usage scenarios for BAT 300 Tempest Technology	page 9
<b>9.1</b>	Mode 1: low power, no supply voltage applied	page 9
<b>9.2</b>	Mode 2: low power, supply voltage applied, slow charging mode	page 9
<b>9.3</b>	Mode 3: low power, supply voltage applied, fast charging mode	page 9
<b>9.4</b>	Mode 4: always-on, no supply voltage applied	page 9
<b>9.5</b>	Mode 5: always-on, supply voltage applied, slow charging mode	page 9
<b>9.6</b>	Mode 6: always-on, supply voltage applied, fast charging mode	page 9
<b>9.7</b>	Summary tables	page 10
<b>9.8</b>	Low power & Always on modes tables	page 10
<b>10</b>	Connection of BAT 300 Tempest Technology	page 11
<b>10.1</b>	Principle of activation	page 11
<b>10.2</b>	Connection to the alarm panel	page 12
<b>10.3</b>	Inputs connection	page 13
<b>10.4</b>	Outputs connection	page 13
<b>11</b>	Shooting time programming	page 14
<b>12</b>	Fluid	page 14
<b>13</b>	Batteries	page 15
<b>14</b>	External LEDs	page 16
<b>15</b>	Final test	page 16
<b>16</b>	Application of the window sticker	page 17
<b>17</b>	Periodic checks	page 17
<b>18</b>	Meaning of the LED'S, Faults & Solutions	page 18
<b>19</b>	Accessories and spare parts	page 19
<b>20</b>	Certifications	page 19
<b>21</b>	Warranty	page 19

# 1 INTRODUCTION

Thank you for purchasing a UR Fog product. The great patented technological innovations make UR Fog devices the fog generators with the best performance in the security market.

The fog generated by UR Fog does not create particular problems or injuries for a human being for a short stay in a fogged room if the system is used according to the manufacturer's recommendations.

The fluid and the generated fog are certified as safe for people, animals and foods from an authorized international certification company and is proved that it does not leave any residual.

UR Fog systems are certified respecting European laws and regulations. Any certifications required in specific countries are a responsibility of the distributor of that specific country. The documents related to certifications can be requested by mail to support@urfog.com

UR FOG **BAT 300 Tempest Technology** operates with very different principles compared to all existing product. It is a battery operated device able to remain in working condition for many months without mains power while still being able to shoot for the maximum settable time. With healthy and fully charged batteries it can remain operational without recharging for more than 6 months. At 6 months it is able to perform a full shot of 60 seconds.

UR FOG **BAT 300 Tempest Technology** can shoot a maximum of 100 m3 of fog with zero visibility (UR FOG standard).

## 2 CONDITIONS OF USE AND SAFETY REQUIREMENTS

- This appliance is not intended for use by person (including children) with lack of experience and knowledge, unless they have been given supervision or instruction concerning use of the appliance by a person responsible for their safety
- Never use UR Fog products for any purpose that is not related to protection from thief or robbery. The choice of the conditions of use in case of robbery will be suggested by your security consultant
- The manufacturer declines all responsibility in case of use of the UR Fog device in the presence of objects and things that may be damaged in contact with substances containing glycol, water and alcohol
- Personnel who may be exposed to the fog emitted by the device must be notified in advance and must be checked that they do not have specific allergies to the aforementioned substances
- At the date of printing of this manual it has never been pointed out any problem related to any allergy. UR Fog is in no way responsible for any damage or condition of use that has not been required and specifically approved by any specific written request prior to the installation of its products
- With regard to the fluid used, carefully consult the document on the safety of the UR Fog fog fluid published on the website [www.urfog.com](http://www.urfog.com)
- Contact a doctor if for any reason you swallow fog fluid or if after contact with eyes or skin you have any kind of reaction, and in any case wash it immediately with water and soap
- Do never stay for a long time in a room filled with fog
- Do not use refills that are not the ones suggested by UR Fog and never try to recharge them, they are made for a single use. Never use different fog fluids or add any other substance into the refills. Keep UR Fog refills out of reach of people and animals
- Follow your national rules for the dispose of empty refills
- When UR Fog BAT 300 Tempest Technology produces fog avoid staying closer than 1 meter from the device
- The device must not be exposed to splashing or dripping water. No objects containing liquids must be placed on the device
- Do not use or charge the UR Fog device in any kind of vehicle except for the devices intended for this type of use
- The main body of BAT 300 Tempest Technology should not be opened unless by specific and authorized service centers
- Do not move the device when it is still hot

## 3 MOBILE APPLICATIONS

For any application on moving vehicles, and in general on vehicles circulating on roads and public areas:

- It is necessary to refer to the regulations in force in the respective Country where the device will be used
- In the situation that the goods compartment may be in contact with the driver's cab, take all precautions so that the fog cannot invade the latter
- It is also necessary to take all precautions so that the device cannot start when the vehicle is in motion, so that the fog cannot for any reason be generated

## 4 PACKAGE CONTENTS

- N° 01 security fog generator BAT 300 Tempest Technology
- N° 02 special batteries 12V / 9Ah
- N° 01 disposable cartridge of 125 ml fog fluid
- N° 01 window sticker
- N° 01 installation manual

## 5 TECHNICAL DATA

### 5.1 Physical features (Table A)

Dimensions (height x width x depth) mm	300 x 200 x 150
Weight included batteries (Kg)	7,6
Weight without batteries (Kg)	1,9
Color	Pure white RAL 9010

### 5.2 Electrical characteristics, consumption and heating time (Table B)

Power supply	Battery
Battery model	n° 2 custom built lead acid VRLA 12V - 9 Ah batteries
Autonomy without external power supply	About 6 months (at 6 months a full time shoot is guaranteed). See Chapter 9
Autonomy with external power supply	No limit. Batteries replacement recommended every 2 years
Inbuilt battery charger	Yes with two external charging current options: 10-16 V / 350 mA and 1 A
External battery charger	Connector for external battery charger present
Average power consumption	Low power mode: 2-3 mW Always on mode: 1,2 W
Heating time from cold	Immediate at the time of shot
Temperature management	Self-balancing of shot with patented system
Operating temperature range	-10°C ..... +50°C

## 5.3 Performance (Table C)

Performance (m <sup>3</sup> ) visibility 1 meter (Standard EN 50131-8: 2019)	100 m <sup>3</sup> with zero visibility (UR Fog standard) in 60 seconds
Number of shots with one cartridge	25 m <sup>3</sup> (8 shots) – 50 m <sup>3</sup> (4 shots) – 100 m <sup>3</sup> (2 shots) + 1 extra test shot
Shot times (sec)	2s (test shot) - 15s (25 m <sup>3</sup> ) - 30s (50 m <sup>3</sup> ) - 60s (100 m <sup>3</sup> )

## 6 POSITIONING AND INSTALLATION

Please observe the following instructions and read the entire manual carefully for installing BAT 300 Tempest Technology: Request to UR Fog or its distributors to take part in courses for installers to ensure the optimal installation of the equipment.

- The device must be installed avoiding to obstruct escape routes. (according to EN50131-8:2019)
- Verify the fog does not limit the visibility near: stairs, landings, moving objects that may cause falls, injuries or any damage to persons
- When using the product in multi-storey buildings, if the escape route runs through an area which is protected by a fogging system, it is recommended to install a vocal warning that provides instructions on the behavior to observe.
- Never direct the fog jet towards an object or a wall less than 2 meters away
- Avoid installing the UR Fog device in front of obstacles that could cause the deflection or blocking of the fog jet, thus preventing its correct diffusion
- Be careful to shoot directly against the windows and doors, as in the event of their breakthrough, the fog tends to escape easily. If these remain open or are uprooted upon intrusion, there is a risk of directing the fog outside the premises
- The dead zone is the wall on which the fog generator is installed. This area will be the last to be saturated as the fog must encounter obstacles to be able to go back. The ceiling dead zone is normally negligible
- Remember that, depending on the models, the fog jet of the UR Fog devices after the first 3 seconds of delivery can exceed 10 meters from the point where the device is installed
- Setting the shooting time interval between the minimum and maximum shown in the shooting table, avoid “overshooting” even if the produced fog is dry and generally doesn’t leave residue. A shot that goes far beyond the recommended seconds can create a residue problems in the protected room
- Install the device at the heights provided for each model by the manufacturer
- Install the systems so that, when the alarm is not activated, they cannot be tampered, for example by occluding the fog emission nozzle
- Don’t activate the UR Fog device before the installation is completed. Insert the refill as the last operation following the procedure described in the manual. It is advisable to perform the first activation test keeping the refill disconnected.
- When the installation is finished, always test the system
- When carrying out functional tests of the UR Fog device, remember to notify the local Fire Brigade in advance, in order to prevent false alarms
- Remember to put warning labels about the presence of UR Fog on the windows or to the access points to the protected area
- Report its installation to the firefighters in your area and eventually to other institutions if needed. Use the notification to the authorities document included in the package

### Choose the surface

For a correct installation, identify a surface (shelf, wall, ceiling or other) that guarantees a safe seal. Use screws, anchors and other restraint systems suitable for the purpose and for the surface.

For wall installation use the orientable bracket to direct the fog downwards (see chapter 19). The fixing holes of the wall bracket are the same of the BAT 300 Tempest Technology.

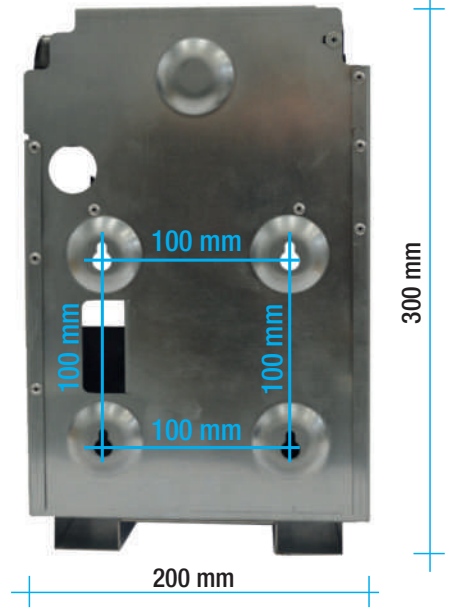

### Positioning and installation heights

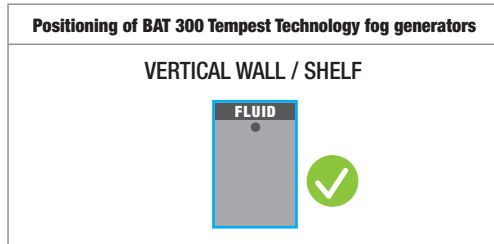

#### BAT 300 Tempest Technology maximum installation heights

The distances are intended between the nozzle and the point of impact on the floor

MODEL	WALL / SHELF without orientable bracket	WALL / SHELF with orientable bracket
BAT 300 Tempest Technology	Max 1,5 m	Max 2,5 m

# 7 CABLE PASSAGES

Use the provided holes for the passage of the signals, power and LAN Cat. 5 cables

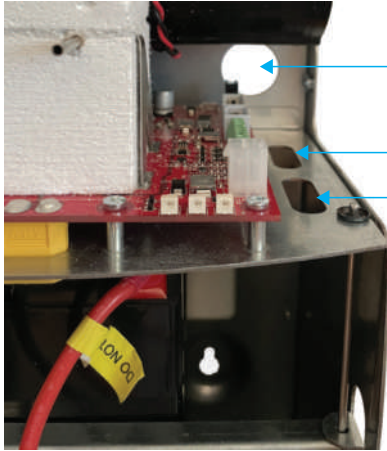

# 8 ELECTRONIC BOARD

## 8.1 General view

S1 Dual dip-switch to program the shooting time

P1 Jumpers for factory programming

W7 Jumper reserved for factory usage

W1 Reserved for factory usage

W2 Partial service mode enable

W3 Always-on / Low power mode

W4 Active security mode enable

W5 Defines pin 9 of J11 as PIR or PANIC input

W6 Defines the function of the PIR input (TRIG validation / stand-alone shooting command)

FLUID (S2)  
Fluid reset button

W8 Jumper to choose the external charger current

J10 Internal 24 V batteries power output connector to power the Active CCloud board or other devices (Using art. FPUBAC 24V - 12V adapter cable)

J6 Extended 10 pin serial port connector

Main screwed connector

J11-1 Positive terminal external 10-16 Volt power supply input

J11-2 GND terminal external 10-16 Volt power supply input

J11-3 Empty fluid tank output

J11-4 Fault output

J11-5 Low battery output

J11-6 Internal battery power output connector

J11-7 ARM input

J11-8 TRIG input

J11-9 PIR/PANIC input

J11-10 GND

J4 Standard 6 pin serial port connector

TEMPEST

J8 Fast charger input connector

Empty fluid or Fault

System armed

External signalling LEDs

## 8.2 Description of the parts (Table D)

Tempest board		TEMPEST line
Name	Function	Note
J4	Standard 6 pin serial port connector	To connect the Active Cloud board or the other UR Fog expansion boards (only in Always-on mode)
J6	Extended 10 pin serial port connector	Besides all the signals on J4 it makes available the power supply (only in Always-on mode)
J8	Fast charger input connector	Designed for the usage of a fast (1A max) battery charger
J10	DC 24 V 500 mA power output connector to power the Active Cloud board or other devices (Using art. FPUBAC 24V - 12V adapter cable)	
J10-1	+24 V	+24 V nominal, 500 mA max
J10-2	GND	Negative terminal
J11	Main screwed connector (Pin 1 is located in the upper side, close to J4)	
J11 - 1	Positive terminal external 10-16 Volt power supply input	Jumper W8 closed: min current 1500 mA
J11 - 2	GND terminal external 10-16 Volt power supply input	Jumper W8 open: min current 350 mA
J11 - 3	Empty fluid tank output	This output (NPN Open Collector max 16 V - 50 mA) closes towards GND when the fluid canister is empty or in reserve
J11 - 4	Fault output	This output (NPN Open Collector max 16 V - 50 mA) closes towards GND when there is a malfunction
J11 - 5	Low battery output	This output (NPN Open Collector max 16 V - 50 mA) closes towards GND when batteries are low
J11 - 6	Internal 24 V batteries power output connector	24 V nominal, 500 mA max. To be used as an alternative to J10
J11 - 7	ARM input	Normally Open dry contact towards GND
J11 - 8	TRIG input	Normally Open dry contact towards GND
J11 - 9	PIR/PANIC input	Normally Closed dry contact towards GND (see W5 and W6)
J11 - 10	GND	GND
W1	Reserved for factory usage	Must be left open
W2	Partial service mode enable	If closed at power-on with S2 pressed: Partial service mode enable
W3	Always-on mode / Low power mode	W3 closed: Always-on mode (Recommended only with external supply) - W3 open: Low power mode
W4	Active security mode enable (Slightly increases consumption)	Inversion of the rest state of the ARM - TRIG inputs and of the FLUID - FAULT - BATTERY outputs from NO to NC W4 closed: NC - W4 open: NO
W5	Defines pin 9 of J11 as PIR or PANIC input	W5 closed: PIR input - W5 open: PANIC input
W6	Defines the function of the PIR input	W6 closed: TRIG validation - W6 open: stand-alone shooting command
W7	Jumper reserved for factory usage	Don't touch
W8	Jumper to choose the external power current	Defines the maximum input current value. See pin J11-1 and J11-2 W8 closed: min current 1500 mA - W8 open: min current 350 mA
S1	Dual dip-switch to program the shooting time 1: left dip-switch 2: right dip-switch	
1 low - 2 low	2 sec	For testing purpose. The next shot will be allowed after 1 minute
1 low - 2 high	15 sec	25 m <sup>3</sup> . The next shot will be allowed after 5 minutes
1 high - 2 low	30 sec	50 m <sup>3</sup> . The next shot will be allowed after 10 minutes
1 high - 2 high	60 sec	100 m <sup>3</sup> . The next shot will be allowed after 20 minutes
S2	Fluid reset button	Also used to set the partial service mode together with W2
P1	Block of three jumpers for factory programming	Don't touch
DL1 RED	External signalling LEDs (from left to right)	Empty fluid or Fault
DL3 BLU	Low-power mode: one blink/min	System armed
DL2 GREEN	Always-on mode: LEDs are always on	System ready



## 9 USAGE SCENARIOS FOR BAT 300 TEMPEST TECHNOLOGY

By properly setting some jumpers on the pcb, the TEMPEST BAT 300 device can be set to work in one of six possible modes as described below.

**ATTENTION:** all jumpers must be inserted / removed ONLY with the device turned off for both low-power and always-on modes.

### 9.1 Mode 1: Low power mode / No supply voltage applied

**Configuration:** W3 open, J11 pin 1-2 not connected

In this mode the device operates fully disconnected by the mains supply. With new and fully charged batteries TEMPEST is able to work for at least 6 months while still being able to make a full time shot with the remaining charge. The serial interface is disabled so no network connection is possible.

### 9.2 Mode 2: Low power mode / Supply voltage applied / Slow charging mode

**Configuration:** W3 open, W8 open, J11 pin 1-2 with supply voltage 10-16V, min 350 mA

In slow charging mode the internal battery charger is enabled and it takes roughly 20 h to completely recover the energy lost in a full time shot (60 s).

The serial interface is disabled so no network connection is possible.

### 9.3 Mode 3: Low power mode / Supply voltage applied / Fast charging mode

**Configuration:** W3 open, W8 closed, J11 pin 1-2 with supply voltage 10-16V, min 1.0 A

In fast charging mode the internal battery charger is enabled and it takes roughly 6 h to completely recover the energy lost in a full time shot (60 s).

The serial interface is disabled so no network connection is possible.

### 9.4 Mode 4: Always-on / No supply voltage applied

**Configuration:** W3 closed, J11 pin 1-2 not connected

In always-on mode the electronic board has all its subsystems always powered on. With new and fully charged batteries TEMPEST is able to work for at least 4-5 days, and around 2 days with an Active Cloud board.

The serial port is enabled and fully working so an Active Cloud board can be connected and the device can be accessed from remote locations. A 24V 12V DC/DC converter is necessary to supply the Active Cloud board (or any other piece of equipment that requires +12 V DC, as is usual in the security field).

### 9.5 Mode 5: Always-on / Supply voltage applied / Slow charging mode

**Configuration:** W3 closed, W8 open, J11 pin 1-2 with supply voltage 10-16V, min. 350 mA

In always-on mode the electronic board has all of its subsystems always powered on. In Slow charging mode the internal battery charger is enabled and it takes up to 3 days to completely recover the energy lost in a full time shot (60 s). The serial port is enabled and fully working so an Active Cloud board can be connected and the device can be accessed from remote locations BUT NO POWER can be drawn from the device so any add-on board, including the Active Cloud board, must be powered from an external source, preferably from the alarm control unit with backup battery in the event of a 230V mains power failure.

### 9.6 Mode 6: Always-on / Supply voltage applied / Fast charging mode

**Configuration:** W3 closed, W8 closed, J11 pin 1-2 with supply voltage 10-16V, min. 1.0 A

In always-on mode the electronic board has all of its subsystems always powered on. In Fast charging mode the internal battery charger is enabled and it takes up to 8 hours to completely recover the energy lost in a full time shot (60 s).

With the Active Cloud board connected the time raises to around 10 hours.

The serial port is enabled and fully working so an Active Cloud board can be connected and the device can be accessed from remote locations. A 24V->12V DC/DC converter is necessary to supply the cloud board (or any other piece of equipment that requires +12 V DC, as is usual in the security field).

## 9.7 Summary tables

The following tables constitute a useful reference to correctly identify and choose the best connection method. The estimated on-time is calculated taken into account a couple of brand new and fully charged original batteries. The impact of a low power PIR sensor connected and powered by the device is also evaluated (not significant).

	Operating mode	Active Cloud	Low power PIR sensor	Estimated on-time	
BAT 300 Tempest Technology self-powered with internal batteries only (no external supply voltage applied)	Low power mode	No	No	6 months	
			Yes	4 months	
	Always-on mode	No	No	4 - 5 days	
			Yes	4 - 5 days	
			Yes	No	2 days
				Yes	2 days

Table 1 - Estimated on-time in low power mode / always on mode, internal batteries only

	Charging mode	Operating mode	Active Cloud	Estimated single shot (60 s) recharge time
BAT 300 Tempest Technology powered with external supply voltage	Slow charge	Low power mode	No	20 h
		Always-on mode	No	3 days
	Fast charge	Low power mode	No	6 hours
			Yes	8 hours
		Always-on mode	No	8 hours
			Yes	10 hours

Table 2 - Estimated single shot (60 s) recharge time

## 9.8 Low power mode & Always on mode tables

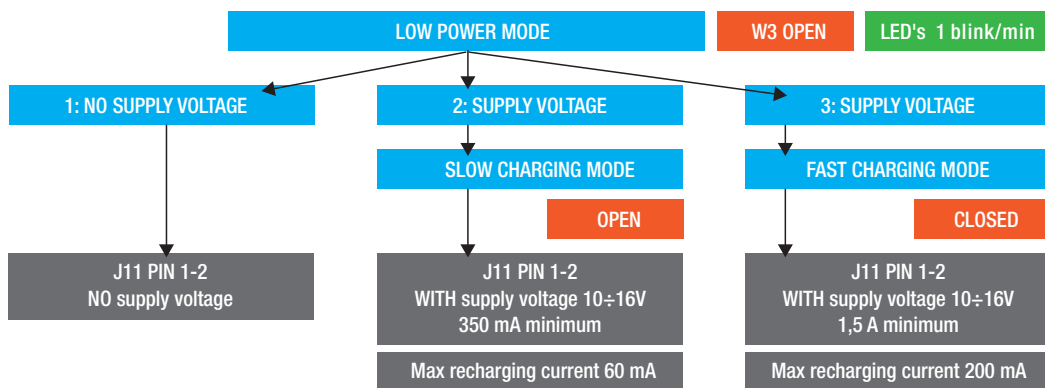

Serial interface disabled / no network connection / Active Cloud board CANNOT be connected

TEMPEST should be able to work for at least 6 months while still being able to make a full time shot with the remaining charge

20 hours to completely recover the energy lost in a full time shot of 60 sec

6 hours to completely recover the energy lost in a full time shot of 60 sec

Every other device draining current from onboard batteries will decrease the working time from 6 months to some days / some hours. With a low power PIR sensor: 4 months

The external voltage can be delivered by the alarm panel itself. Minimum current available from the alarm panel supply output must be greater than or equal to 350 mA

The external current CANNOT be delivered by the alarm panel (minimum available current must be greater than or equal to 1 A). An external power supply is necessary

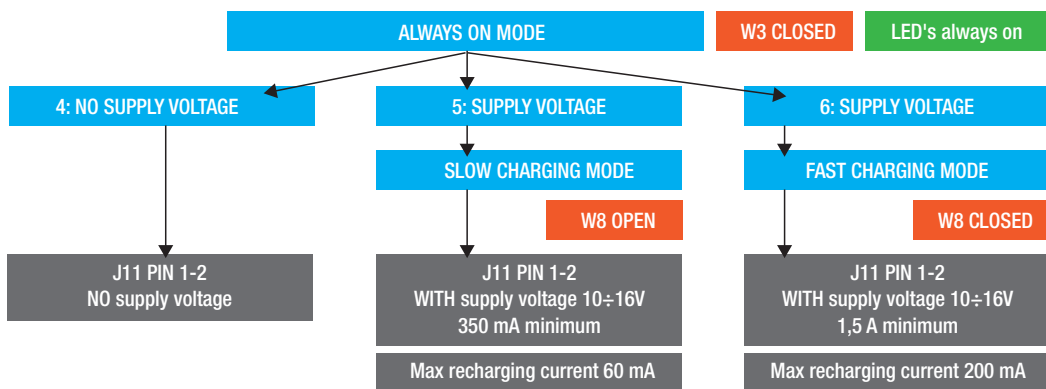

Serial interface enabled / network connection / Active Cloud board CAN be connected

The electronic board has all its subsystems always powered on.  
Estimated on-time with new and fully charged batteries: 4-5 days. With Cloud board connected: 2 days

Up to 3 days to completely recover the energy lost in a full time shot of 60 sec

Up to 8 hours to completely recover the energy lost in a full time shot of 60 sec  
With Cloud board connected: around 10 hours

Every other device draining current from onboard batteries will decrease the working time from 4-5 days to some days / hours

The external voltage could be delivered by the alarm panel itself. Care must be taken to ensure the minimum current available from the alarm panel supply output must be greater than or equal to 350 mA, increasing to 500 mA with Cloud board connected

Because of the higher current requirements, it could not be possible to supply the TEMPEST machine from an alarm panel thus making an external power supply a necessary part

A 24V 12V DC/DC converter is necessary to supply the cloud board or any other piece of equipment that requires +12 V DC

No current can be drawn from the machine so any add-onboard must be powered from an external source

A 24V 12V DC/DC converter is necessary to supply the cloud board or any other piece of equipment that requires +12 V DC

## 10 CONNECTION OF BAT 300 TEMPEST TECHNOLOGY

### 10.1 Principle of activation

To shot fog the following requirements must be fulfilled SIMULTANEOUSLY:

- Fog Generator Ready (green LED steady on) and no critical error present
- Alarm system armed (ARM input active - blue LED steady on)
- Intrusion alarm signal on the TRIG input
- Alarm validation on the PIR input (if present)

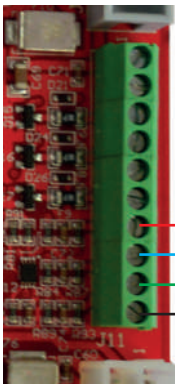

### DAYTIME

Alarm system **DISARMED ARM Open**  
Fog device **DISARMED**

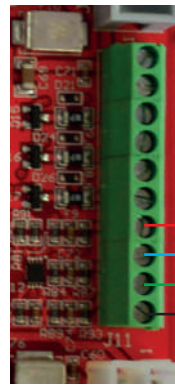

### NIGHTTIME

Alarm system **ARMED ARM Closed**  
Fog device **ARMED**

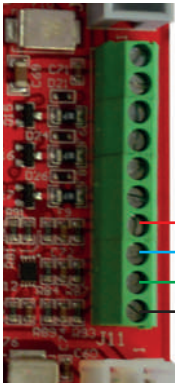

### NIGHTTIME - ALARM

Alarm system **ARMED ARM Closed**  
Intrusion detected **TRIG closed**  
Intrusion not verifcated **PIR closed**  
Fog device **READY TO SHOOT**

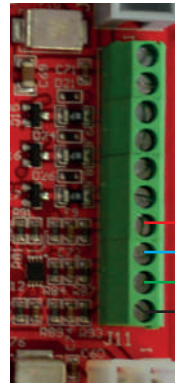

### NIGHTTIME + ALARM + VERIFICATION

Alarm system **ARMED ARM Closed**  
Intrusion detected **TRIG closed**  
Intrusion verifcated **PIR open**  
Fog device **SHOOTING**

## 10.2 Connection to the alarm panel

BAT 300 Tempest Technology can be connected to an alarm panel in the same way as other models of the UR Fog range. It can be also driven by the serial interface (i.e., with an Active Cloud Board).

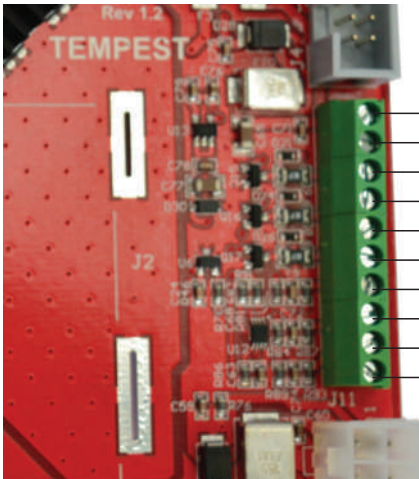

- 1) +12 V power supply input
- 2) GND power supply input
- 3) Empty fluid tank ouput
- 4) Fault ouput
- 5) Low battery ouput
- 6) Internal battery power ouput
- 7) ARM Input
- 8) TRIG Input
- 9) PIR/PANIC Input
- 10) GND

## 10.3 Inputs connection

The ON/OFF output of this alarm panel is an NPN Open collector open when the system is OFF, which closes permanently to ground (GND) for as long as the same remains in ON. This output is connected to the pin 7 "ARM".

The ALARM output of this alarm panel is an NPN Open collector open when the system it is at rest, which closes to ground (GND) for XX seconds in case of intrusion. This output is connected to the pin 8 "TRIG".

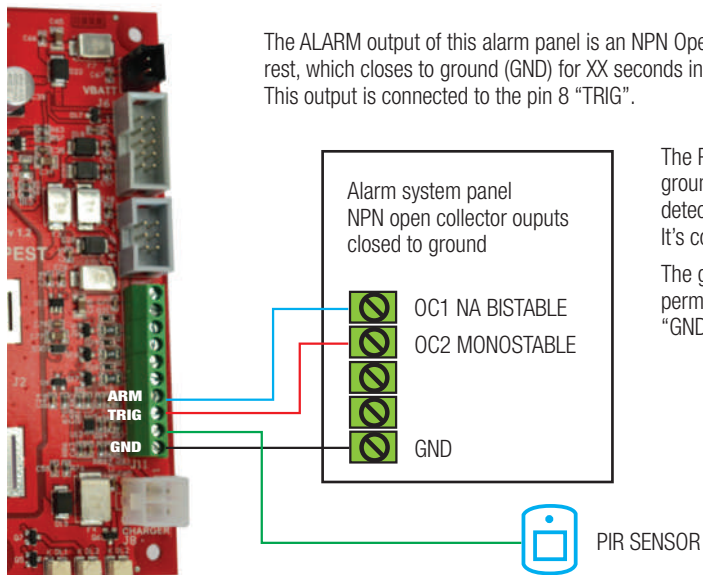

The PIR sensor is a normally closed to ground (GND) contact which opens in case of detection.

It's connected to the pin 9 "PIR".

The ground (GND) of the alarm panel is permanently connected to the pin 10 "GND" of TEMPEST.

### PIR/Panic input

Input 9 can be defined as PIR verification or Panic by adding a jumper across W5. W5 closed: PIR input W5 open: PANIC button. This is an open collector input. (Dry contact to Gnd).

### PIR input mode

With W5 closed, the jumper W6 defines the function of the PIR input. W6 closed: TRIG validation W6 open: stand alone shooting command

## 10.4 Outputs connection

The EMPTY FLUID (NPN Open collector 50mA max) output closes to ground (GND) when the fluid cartridge is empty or in reserve (one shoot still available).

The FAULT (NPN Open collector 50mA max) output closes to ground (GND) when it is a malfunction.

The LOW BATTERY (NPN Open collector 50mA max) output closes to ground (GND) when batteries are low.

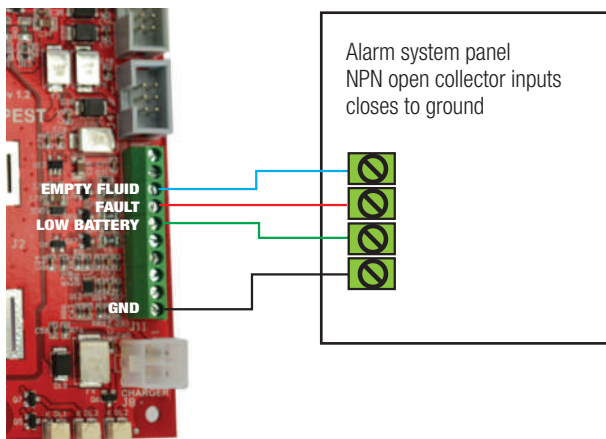

# 11 SHOOTING TIME PROGRAMMING

There are four possible configurations to program the shooting time via the S1 dipswitch. The dipswitch can be set before any shot and there is no need to power cycle the device to set the shooting time.

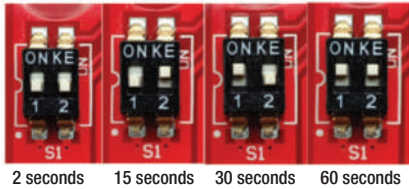

Note: After a shot the processor introduces a cooling time during which any subsequent shot is not allowed until after a specific time has elapsed:

- 2 s shot – 1 min delay
- 15 s shot – 5 min delay
- 30 s shot - 10 min delay
- 60 s shot - 20 min delay

The device will not accept a shooting command before this time interval expires. Although by power cycling the device could be forced to shoot immediately, without waiting for the inter-shot interval time expiration. This will probably destroy the device. THEREFORE DO NOT BYPASS WAITING TIME!

# 12 FLUID



The fluid solution is provided in non-pressurized cartridge making it easy to substitute. A self-aligning mechanism ensures that the cartridge is always fitted correctly. The contents of the cartridges are mechanically determined and may vary + or - 5%, and each cartridge contains enough fluid to allow for 2 full time shots (60 s) and at least one test shot (2 s). Fluid cartridges are disposable and CANNOT be recharged.

## Technical data (Table E)

Fluid cartridge capacity (ml)	125
Disposable non-pressurized cartridge	Yes
Certified White Out Food Grade fluid	Yes
Performance (m <sup>3</sup> ) visibility 1 meter (Standard EN 50131-8: 2019)	100 m <sup>3</sup> with zero visibility (UR Fog standard) in 60 seconds*
Number of shots with one cartridge	25m <sup>3</sup> (8 shots) – 50m <sup>3</sup> (4 shots) – 100m <sup>3</sup> (2 shots) + 1 extra test shot
Shot times (sec)	2s (test) - 15s (25m <sup>3</sup> ) - 30s (50m <sup>3</sup> ) - 60s (100m <sup>3</sup> )

\* The cubic meters of generated fog are based on the rules defined by the EN 50131-8: 2019 standard which prescribes a visibility of less than 1 meter. The cubic meters of generated fog mentioned in the table are based on the UR Fog standard which prescribes a visibility of 50 cm.

## Insert or change the fluid cartridge

NOTE 1: The device will autonomously detect a low fluid condition and it will stop shooting. In this case no try to shoot again!

NOTE 2: Before removing the cabinet, check that the alarm control unit is in the “Service” condition, so as to be sure not to cause accidental shot.

NOTE 3: To insert or change the fluid cartridge is not necessary to turn off the fog generator.

**WARNING!!** All UR FOG fogging systems should only be used with UR FOG-branded fluids. It is strictly forbidden to use any fluid not previously authorized in writing by UR FOG srl.

There are 3 cartridge handling conditions:

- FIRST INSTALLATION
- CARTRIDGE REPLACEMENT IN FLUID ALARM CONDITION AND EMPTY CARTRIDGE (cartridge ended during shot, firing test with cartridge empty or without cartridge)
- CARTRIDGE REPLACEMENT WITHOUT FLUID ALARM CONDITION OR WITH ALARM CONDITION BUT CARTRIDGE NOT EMPTY

For each condition, follow the procedure below:

1. Unscrew the empty cartridge
2. Insert the new cartridge and screw it all the way in without overtightening
3. Press the FLUID button (S2) for 5 seconds (buzzer sounds) until pump activation is heard \*\*
4. Perform a 2 seconds shooting test following the procedure below:
  - take note of the switch S1 position (shooting time)
  - program the 2 seconds shooting test (S1: 1 low-2 low)
  - make the 2 seconds shooting test \*\*
  - reprogram the original shooting time

**The procedure can be defined as completed only in the absence of errors at the end of shooting (red led off). Otherwise (red led on) repeat the procedure from point 3**



\*\* A few drops of fluid may come out of the nozzle.

During these phases, do not position yourself in front of the nozzle and direct the shoot towards an area that cannot be damaged by any residual fog fluid.

NOTE 4: At each cartridge change, check that the silicone nozzle protection is integral with the nozzle itself and does not come off easily. In this second case, replace the protection with a new one.



## 13 BATTERIES



BAT 300 Tempest Technology is powered by two, bespoke, lead acid VRLA 12 V - 9 Ah batteries. With healthy and fully charged batteries it can remain operational without recharging for more than 6 months. At 6 months it is still able to perform a full shot of 60 seconds.

**For use in the absence of power supply (stand alone mode) it is necessary to fully charge the batteries before the first activation.**

### Insert or change the batteries

To insert and replace the batteries, follow the rules as below:

- Open the compartment cover
- Disconnecting and removing the old batteries (if present)
- Insert the new batteries into the compartment
- Close the compartment cover ensuring that the battery supply cables are out and accessible
- Connect the batteries connectors firmly AS FAR AS THEY WILL GO
- The buzzer plays three notes and the three LEDs blink for 5 seconds (Low power mode) or steady on (Always on mode)

NOTE 1: The use of standard batteries available on the market doesn't guarantee the performances declared in this manual



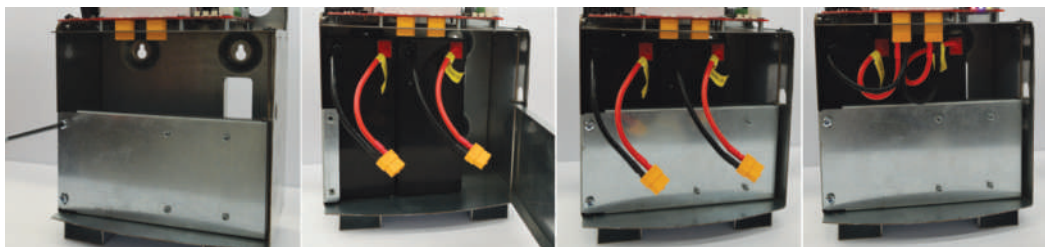

NOTE 2: after 2 minutes from the connection the electronic board test the batteries powering the heating system. At this time a small puff of fog might come out from the nozzle. Don't stand in front of the nozzle in this period.

NOTE 3: in any case, don't position yourself below one meter away from the nozzle when the device is switched on.

## 14 EXTERNAL LEDs

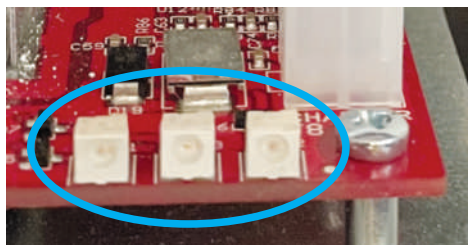

BAT 300 Tempest Technology provide three external LEDs.

The LEDs will emit a short blink once per minute (Low-power mode) or are always active (Always on mode) as follows:

**Red LED** to indicate the empty fluid or a fault

**Blue LED** to indicate the arm status

**Green LED** to indicate the ready condition

See Chapter 18 about errors and their solutions.

## 15 FINAL TEST

At the end of each installation it is essential to test the entire safety system (alarm panel, fog generator, other devices). Here's a CHECKLIST example for finalizing the installation:

- Check all signals to and from the alarm system
- Check that the fog device is READY before carrying out the test (System READY = GREEN LED on)
- Make a FULL TEST SHOOTING at the installation site, to ensure that the dimensioning is OK
- After the test insert a new refill and RESET the fluid counter
- Register the device on the free ACTIVE CLOUD platform (if an ACTIVE CLOUD LAN WiFi card is present)
- Make sure to give a full INSTRUCTION to the end-user of this installation



## 16 APPLICATION OF THE WINDOW STICKER



The window sticker provided with each UR Fog Generator is required to warn and deter intruders from committing theft in the protected facility. The signage must be displayed prominently on the building protected by the UR Fog fog generator according to EN50131-8:2019. It is double-sided to allow visibility from the outside as well as from the inside.

## 17 PERIODIC CHECKS

UR Fog security fog systems do not require special controls. The system monitors its functions 24 hours a day, reporting any anomalies. It is therefore sufficient to manage the reports correctly.

It's however recommended to periodically check the entire safety system.

Regarding the fog generator, here is an example of checklist:

- Make sure the batteries are not hot and / or swollen. In any case, always refer to chapter 13 Batteries
- Check that the closing screws and wall fixing screws are well tightened and if necessary tighten them fully
- Check that the nozzle is not deformed and that there are not foreign bodies inside it
- Check that the silicone nozzle protection is integral with the nozzle itself and does not come off easily. In this second case, replace the protection with a new one
- Annually check the pneumatic seal of the circuit and the pump by firing fog. If you don't want to emit the set amount of fog, simply use the test shot function (2 seconds)
- Intervention report redaction and release of conformity declaration according to local rules

# 18 MEANING OF THE LED'S, FAULTS & SOLUTIONS

TEMPEST line: Meaning of the LED's, Diagnostic and troubleshooting

## ALWAYS-ON MODE: LED's always ON

LED STATUS	CAUSE	MEANING	BUZZER
GREEN/BLUE/RED Led's are steady ON together for 5 sec	Status	Connection of the batteries - system switched ON	3 tones
The GREEN LED is OFF	Status	System not ready	No tone
The GREEN LED is steady ON	Status	System ready	
The BLUE LED is OFF	Status	System not armed	
The BLUE LED is steady ON	Status	System armed	
The RED LED is OFF	Status	No fault	
The RED LED is steady ON	Fault	Fluid cartridge is in reserve or empty, batteries low	
The RED LED blinks	Fault	Hardware failure or inefficient batteries	

## LOW POWER MODE: LED's blinks 1 time / minute

LED STATUS	CAUSE	MEANING	BUZZER
GREEN/BLUE/RED Led's are steady ON together for 5 sec	Status	Connection of the batteries - system switched ON	3 tones
The GREEN LED is OFF	Status	System not ready	No tone
The GREEN LED blinks 1 time / min	Status	System ready	
The BLUE LED is OFF	Status	System not armed	
The BLUE LED blinks 1 time / min	Status	System armed	
The RED LED is OFF	Status	No fault	
The RED LED is steady ON	Fault	Hardware failure or inefficient batteries	
The RED LED blinks 1 time / min	Fault	Fluid cartridge is in reserve or empty, batteries low	

## Troubleshooting

PROBLEM	RESULT / CAUSE	SOLUTION	BUZZER
Low batteries	Shot is still available	Replace or recharge batteries - See chapter 13	3 tones
Inefficient batteries	Shot is not available		
Fluid reserve	A shot is still available	Change the fluid cartridge and press the fluid button	2 tones
Empty fluid	Shot is not available		
The voltage on +12 V input is too low or too high	Batteries are not charging	Check the external power supply or the alarm panel output	No tone
Impossible to arm the device. BLUE LED doesn't switch ON	Wiring error	Check the wiring, the ARM input should be connected to the GROUND when the anti-theft system is activated	
	Jumper W4 configuration error	Check the right configuration for the ARM input: W4 open: NO W4 closed: NC	
The device is armed, BLUE LED is ON but doesn't shoot	Wiring error	Check the wiring, the TRIG input should be connected to the GROUND when the anti-theft system is in alarm condition	
	Jumper W4 configuration error	Check the right configuration for the TRIG input: W4 open: NO W4 closed: NC	
	The front RED LED is ON	A fault is present. Search in this guide	
The silicone nozzle protection is loose and no longer fixed		Change the nozzle protection. See chapter 12 Fluid	

## 19 ACCESSORIES AND SPARE PARTS

Use the accessories provided by UR Fog to optimize the installation.

Product code	Accessories and spare parts
FPUB300	BAT 300 (Fluid refill and 2 battery included)
FPUBBY	12V 9Ah battery
FPUBFT	Fluid refill
URCLWFC	Active Cloud LAN/WIFI board with cables (WIFI opt.)
URCLWFA	WIFI antenna module
FPUBAC	24V - 12V adapter cable (Active Cloud, etc.)
FPUBEFC	External fast charger
FPUB220PS	220V power supply
FPUBNP	Silicone nozzle protection
FPUWB	Orientable wall bracket

## 20 CERTIFICATIONS

All UR Fog devices and fluids comply with the provisions of the European and international authorities. Any certifications required in a specific country are the responsibility of that country's distributor. The documents relating to the certifications can be requested via email from [assistenza@urfog.com](mailto:assistenza@urfog.com)

## 21 WARRANTY

The warranty of UR Fog BAT 300 TEMPEST TECHNOLOGY is 1 year.

The warranty of the cartridges and of the contained fluid is 2 years.

The warranty of the batteries is 1 year, and only the production faults are covered.

The warranty is handled directly from the dealer or authorized installer, so please contact your supplier to take advantage of warranty with the copy of the purchase document that contains the serial number of the machine. Not included in the warranty: moving parts and/or damages depending on the incorrect use unless it is found a manufacturing defect in origin.

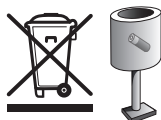

We recommend to throw away the batteries in the appropriate waste containers for recycling.



BY BREAKING THE SECURITY LABELS AND THE OPENING OF THE MACHINE YOU WILL ACCEPT WHAT IS WRITTEN ON THIS MANUAL AND ON THE WEB SITE: [www.urfog.com](http://www.urfog.com)

# FORM FOR THE AUTHORITIES



## Notification of successful installation

Hereby informs that UR FOG machine, model \_\_\_\_\_  
has been connected to the alarm system at:

Company Name	
Address	
Referent	E-mail address
Phone number	Mobile number

The fog machine generates a dense fog when an intrusion occurs to impede the visibility to the intruder.  
The fog is safe for people, animals, things and food.  
This notification has been sent or delivered to:

Firemen	
Referent	E-mail address
Phone number	Mobile number
Public security	
Referent	E-mail address
Phone number	Mobile number
Private security	
Referent	E-mail address
Phone number	Mobile number

AUTHORIZED INSTALLER: \_\_\_\_\_

PLACE: \_\_\_\_\_ DATE: \_\_\_\_\_

SIGNATURE AND STAMP: \_\_\_\_\_

UR FOG S.r.l. Sede legale / Legal Office : via Giacinto Collegno n°11 - 10143 Torino - Italy  
Sede operativa e magazzino / Operation and delivery to : via Toscana n° 38 - 10099 San Mauro Torinese - Italy  
C.F. / P.iva 10224800010 - Reg. Imprese TO - 1157030 - Cap. Soc. Euro 10.000 int. versat.  
Tel. +39 011 0133037 - Fax +39 011 0133005 - e-mail : amministrazione@urfog.com

Report the successful installation to the authority  
using the form that can be downloaded from the  
website or by requesting it by e-mail writing to support@urfog.com

**TO USE UR FOG FOGGING SYSTEMS WITH PURIFOG/PURIFOG  
HYPO FLUIDS FOLLOW THE DATASHEETS INSTRUCTIONS  
AVAILABLE FOR DOWNLOAD ON WWW.PURIFOG.COM**

UR FOG Srl reserves the rights to modify the characteristics of the product  
for the sole purpose of improving its characteristics and performance.

