

**Applicable Model**

X916

**Drawing Title**

Intercom Panel

**Drawing Unit**

mm

**Drawing Scale**

Not to scale

**DRAFT  
SUBJECT TO  
CHANGE**

**Last Revised**

December 31,2019

**Drawing Version**

V1.0

**Page**

1 of 5

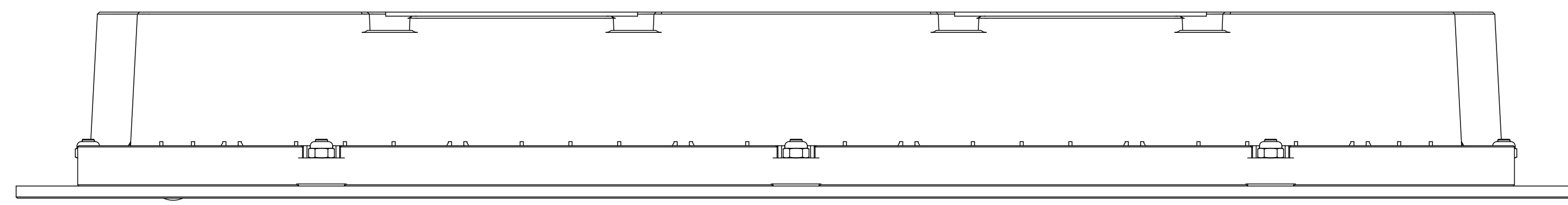

5 TOP VIEW

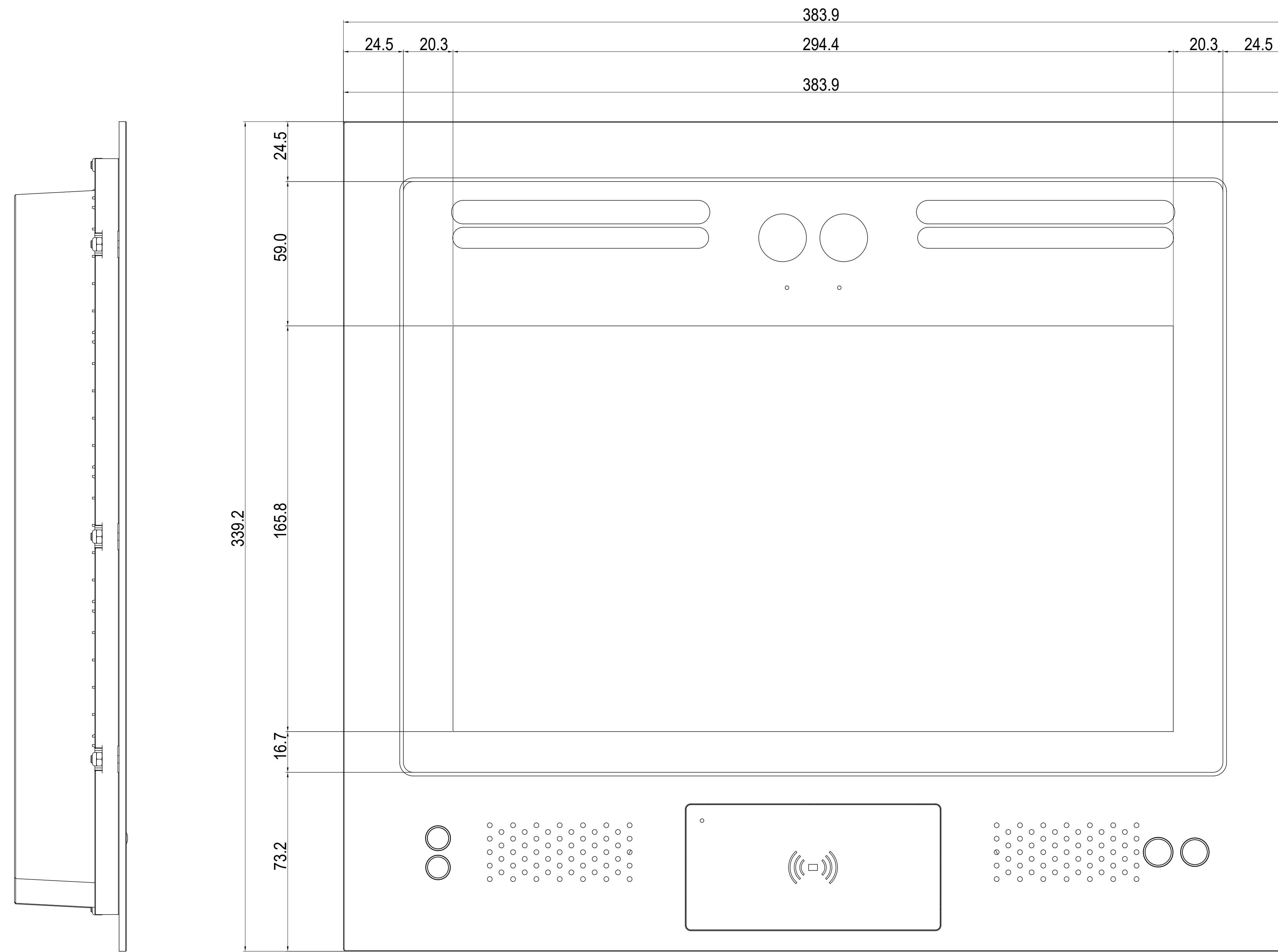

1 FRONT VIEW

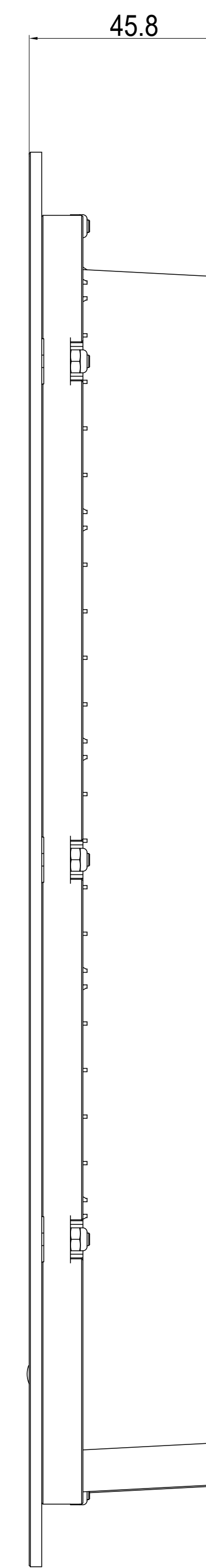

3 LEFT VIEW

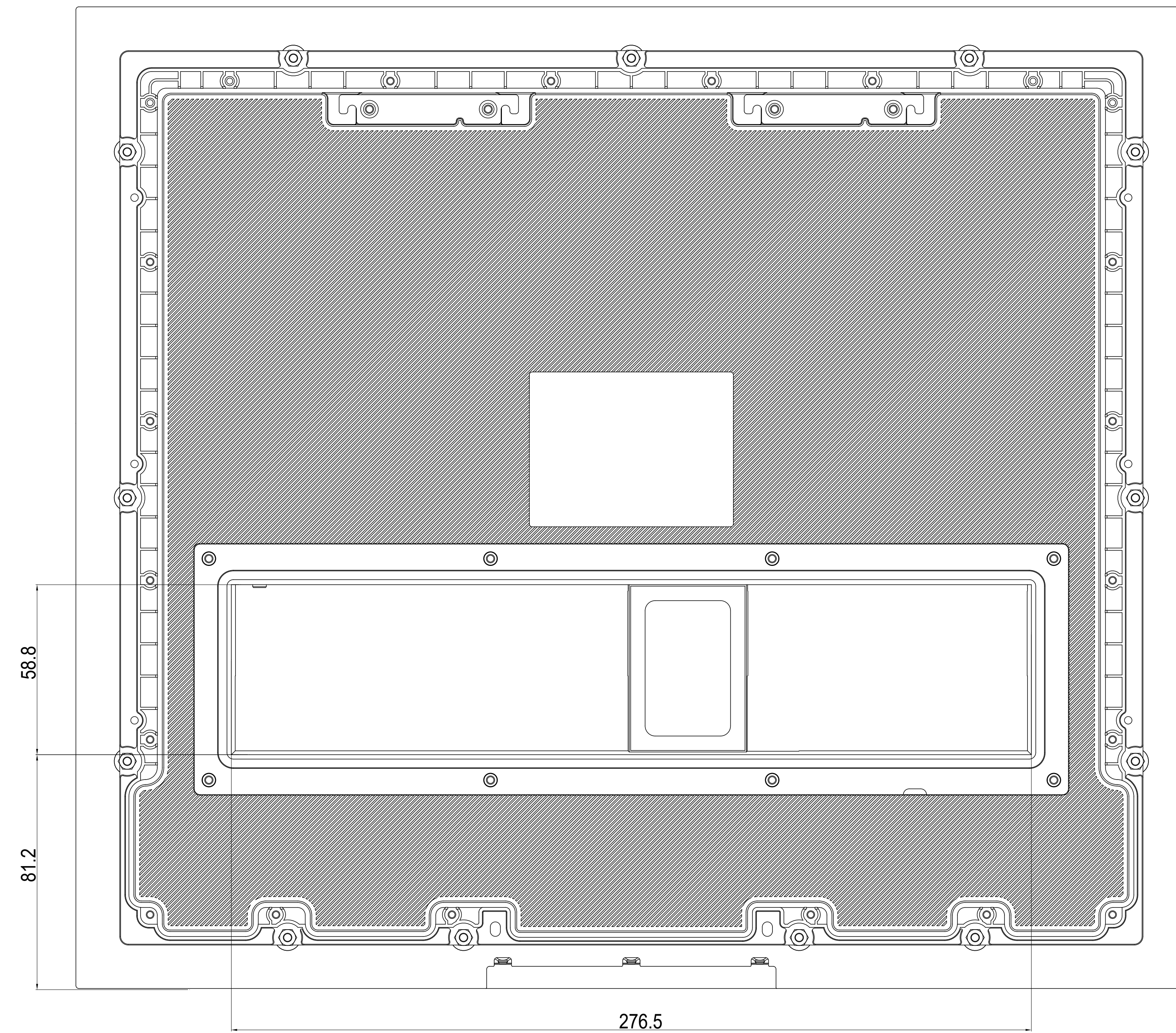

4 BACK VIEW

2 RIGHT VIEW

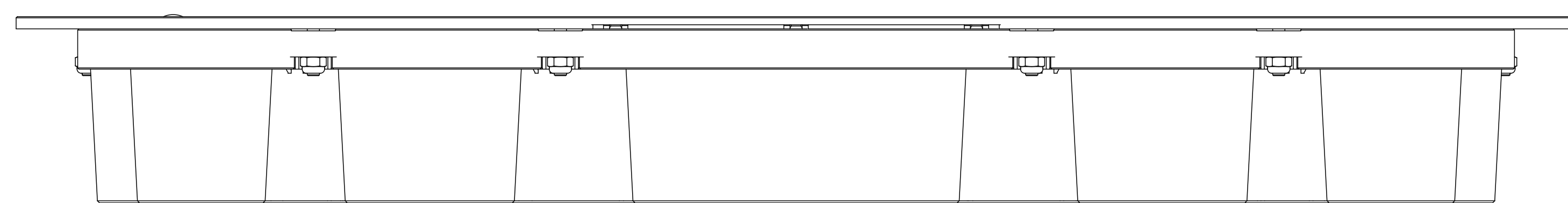

6 BOTTOM VIEW

**Applicable Model**

X916

**Drawing Title**

Flush Mounting Box

**Drawing Unit**

mm

**Drawing Scale**

Not to scale

**DRAFT  
SUBJECT TO  
CHANGE**

**Last Revised**

December 31,2019

**Drawing Version**

V1.0

**Page**

2 of 5

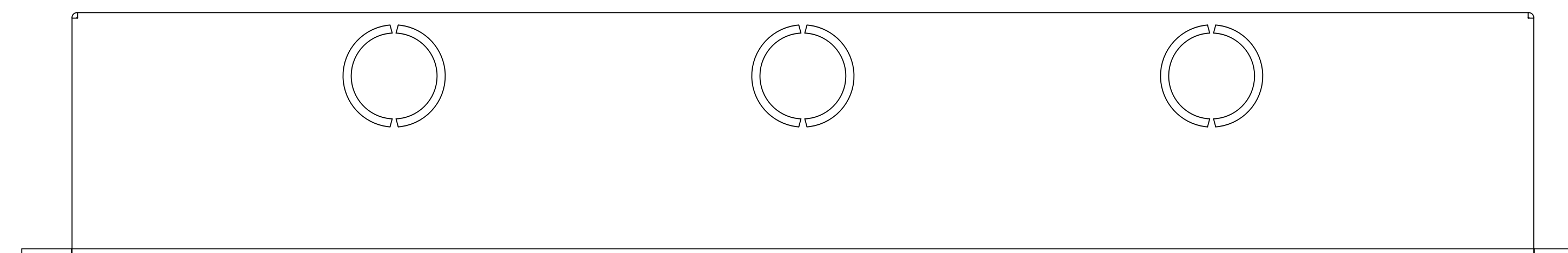

5 TOP VIEW

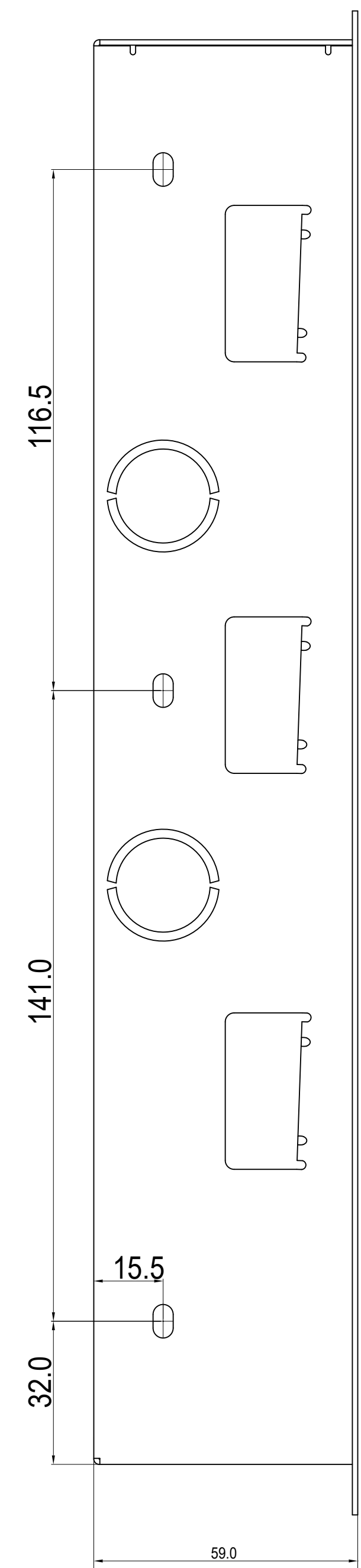

2 RIGHT VIEW

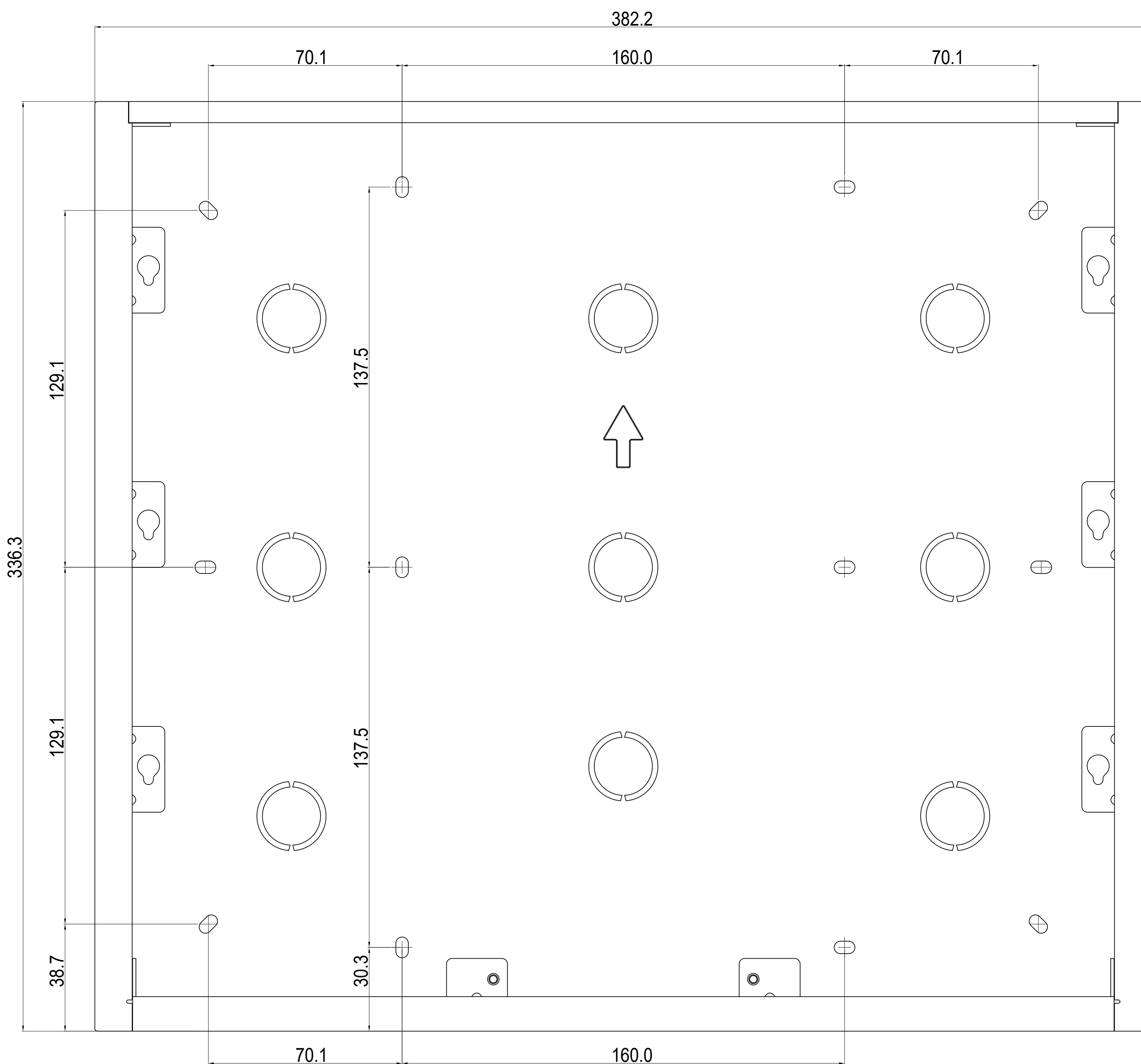

1 FRONT VIEW

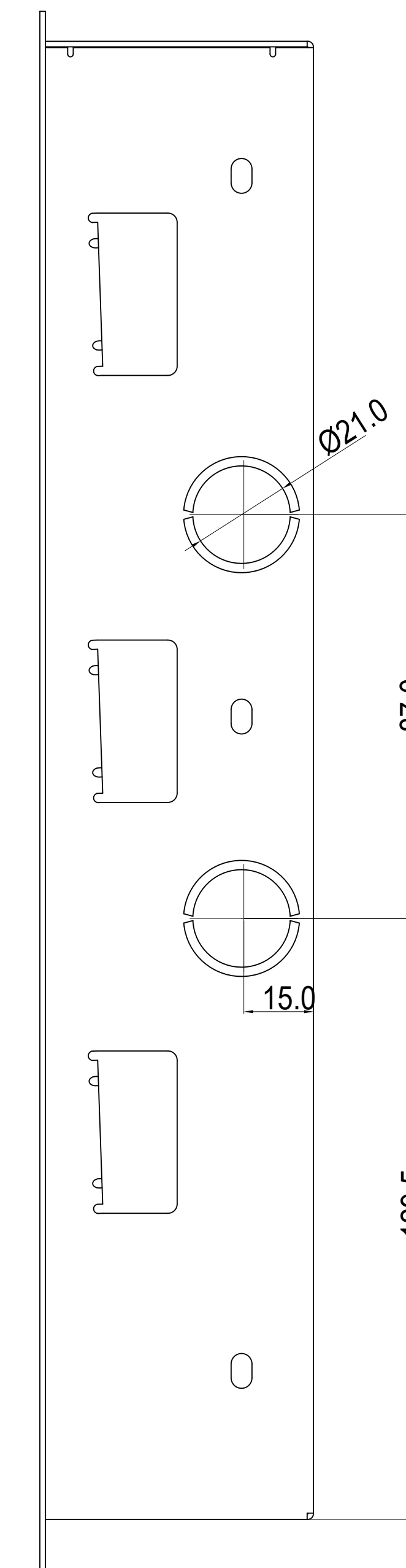

3 LEFT VIEW

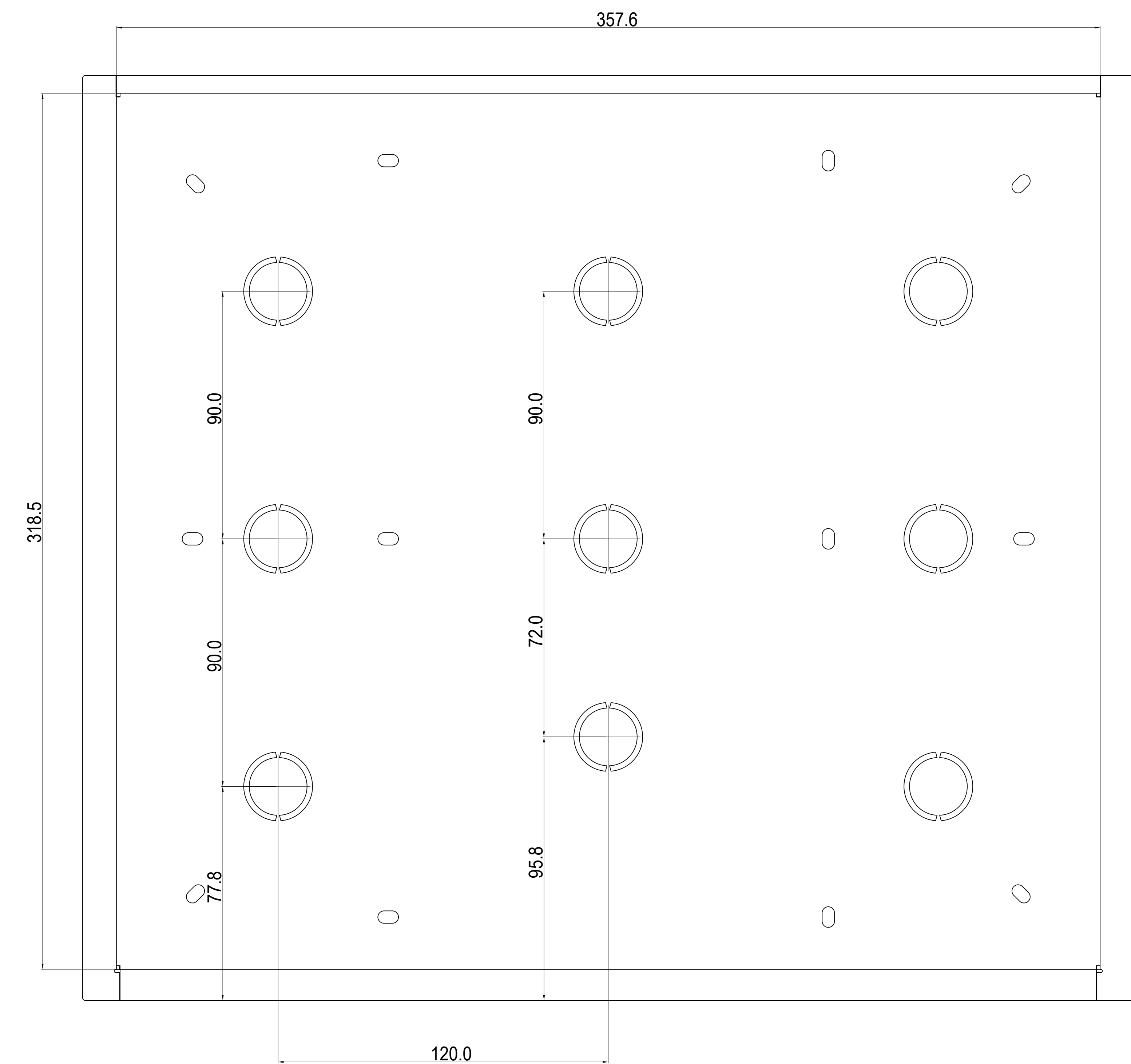

4 BACK VIEW

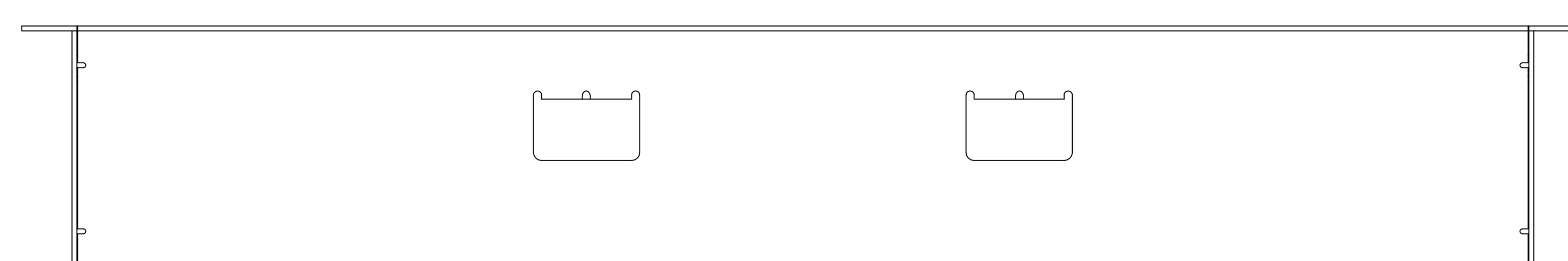

6 BOTTOM VIEW

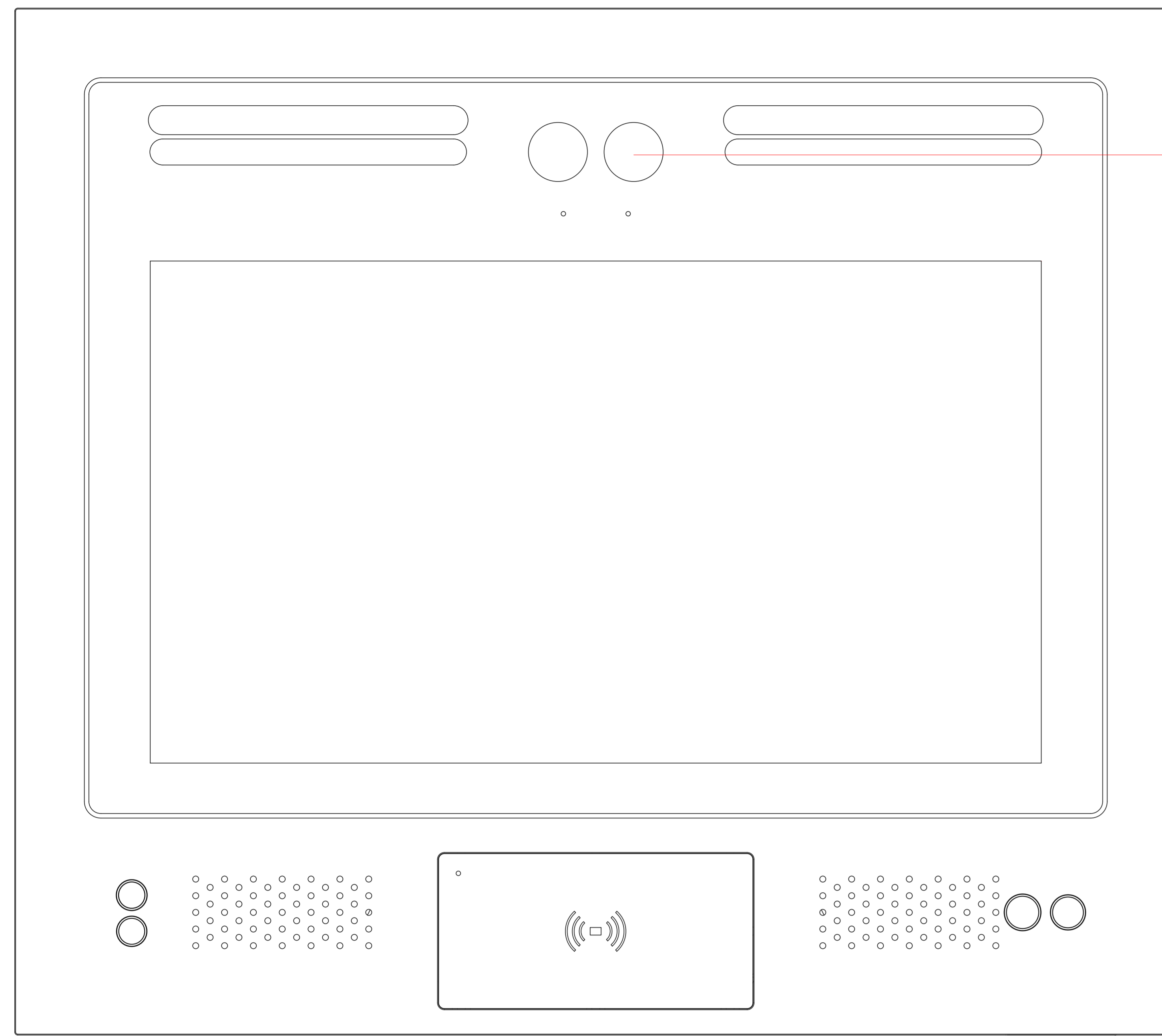

1218mm TO BOTTOM OF PANEL

1500mm TO CENTER OF CAMERA

ADA Compliance Requirement



GROUND

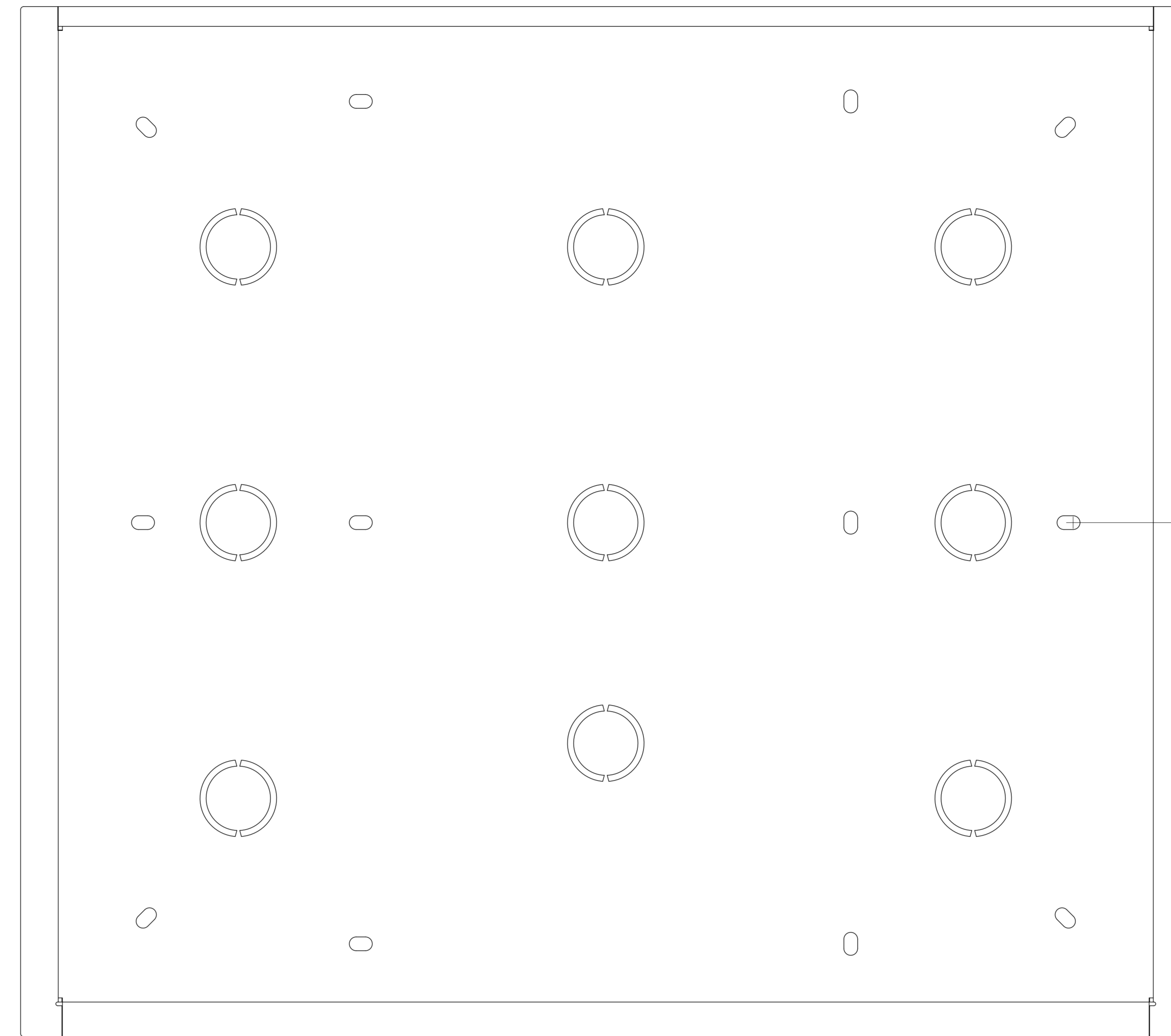

1231mm TO BOTTOM OF BRACKET

1388mm TO SCREW HOLE CENTER OF BRACKET

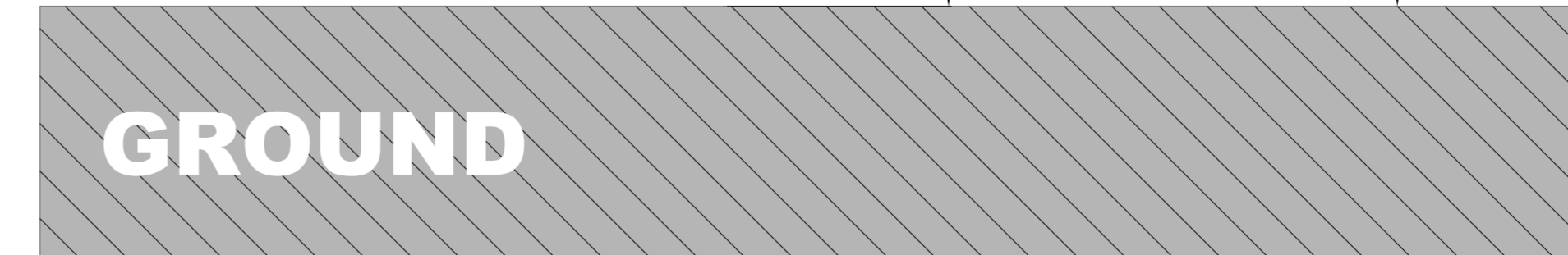

GROUND

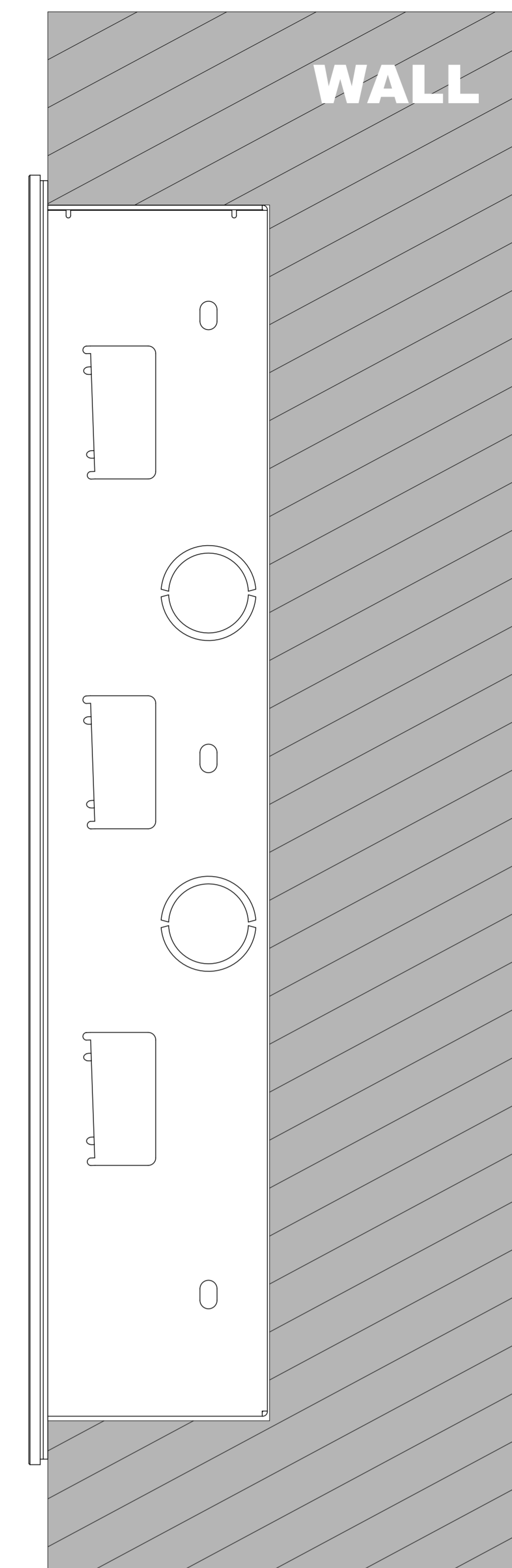

WALL

**Applicable Model**

X916

**Drawing Title**

Wall Mounting Box

**Drawing Unit**

mm

**Drawing Scale**

Not to scale

**DRAFT  
SUBJECT TO  
CHANGE**

**Last Revised**

December 31,2019

**Drawing Version**

V1.0

**Page**

4 of 5

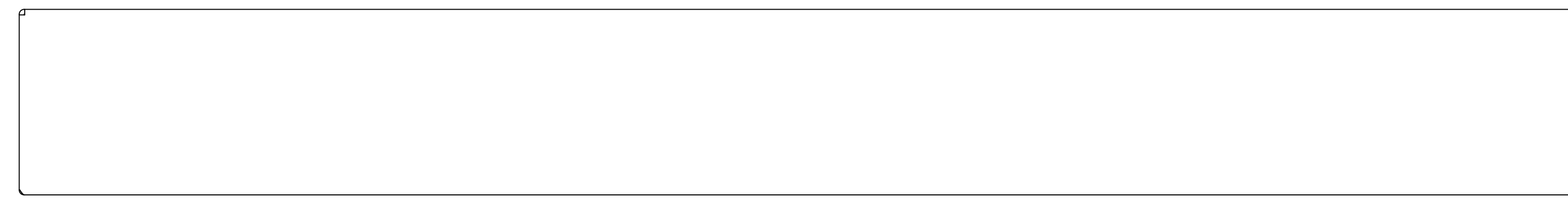

5 TOP VIEW

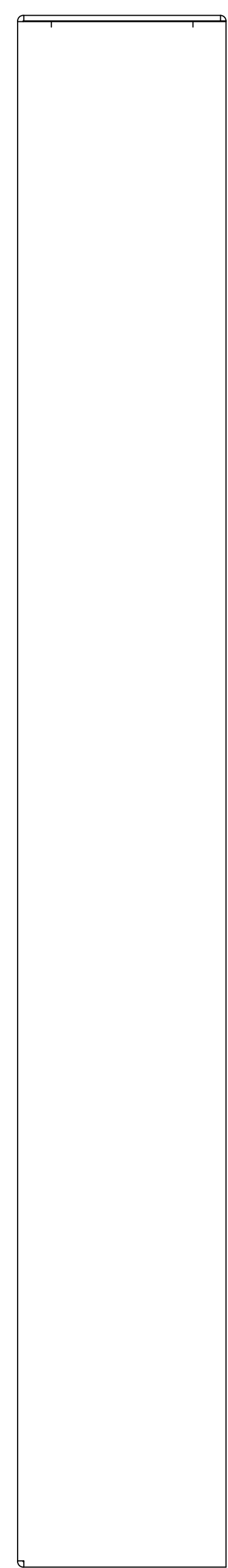

2 RIGHT VIEW

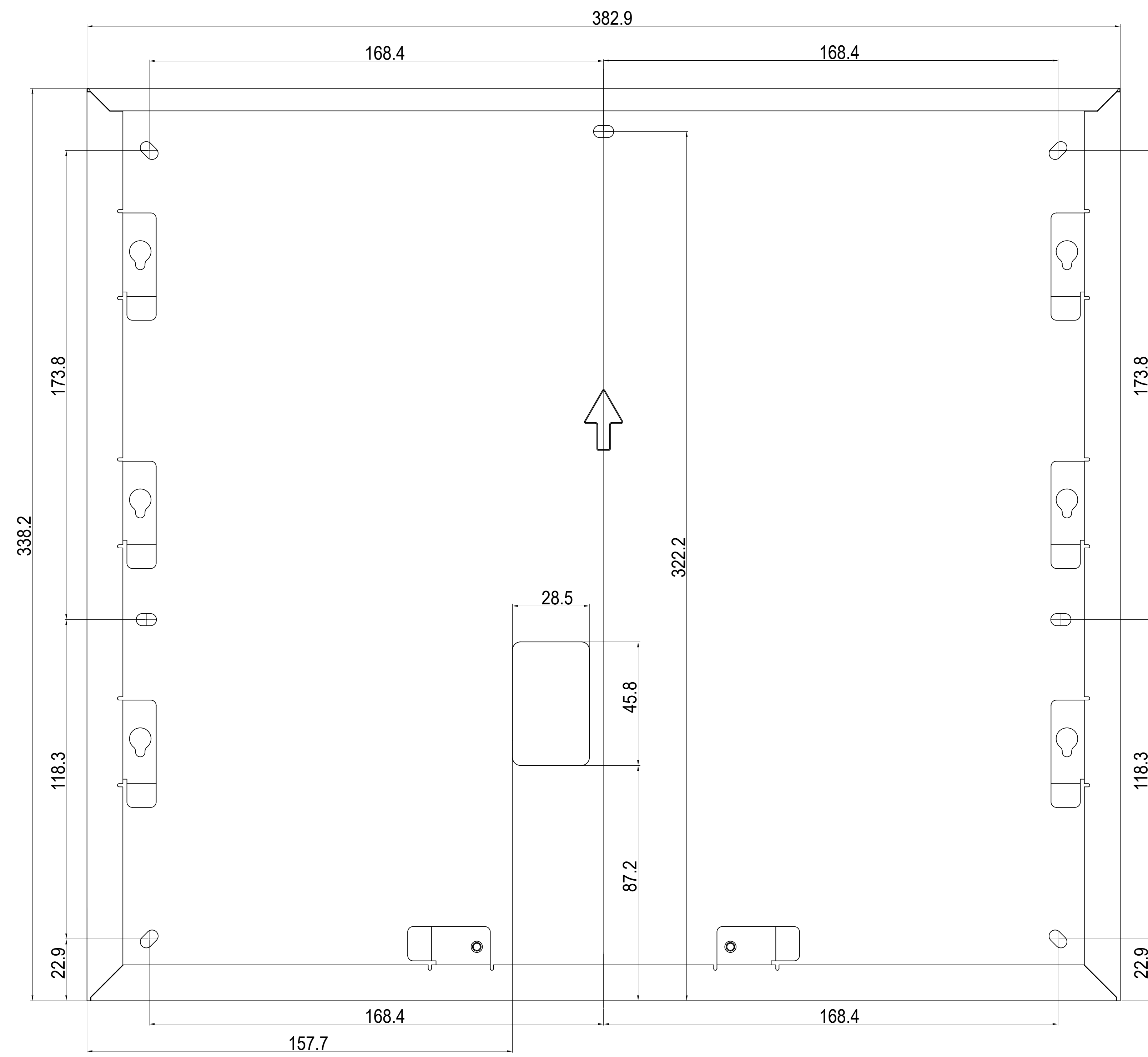

1 FRONT VIEW



3 LEFT VIEW

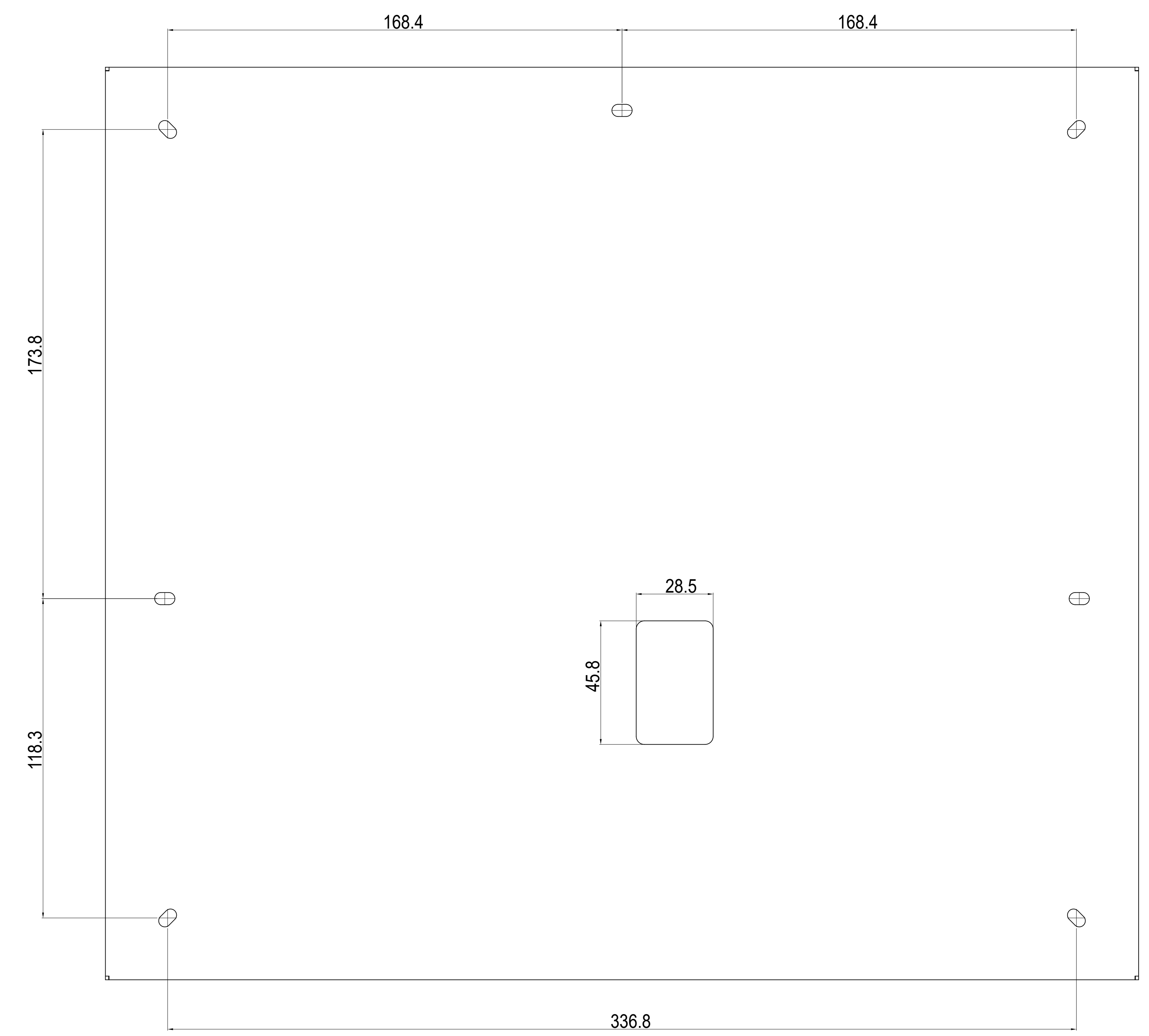

4 BACK VIEW

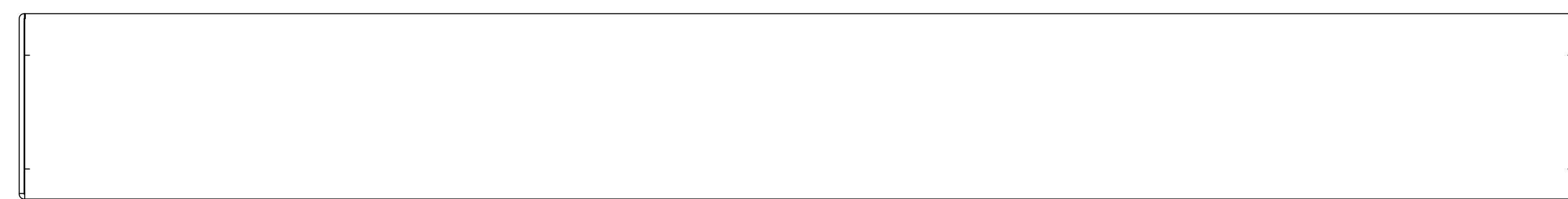

6 BOTTOM VIEW

**Applicable Model**

X916

**Drawing Title**

Placement

**Drawing Unit**

mm

**Drawing Scale**

Not to scale

**DRAFT  
SUBJECT TO  
CHANGE**

**Last Revised**

December 31,2019

**Drawing Version**

V1.0

**Page**

5 of 5

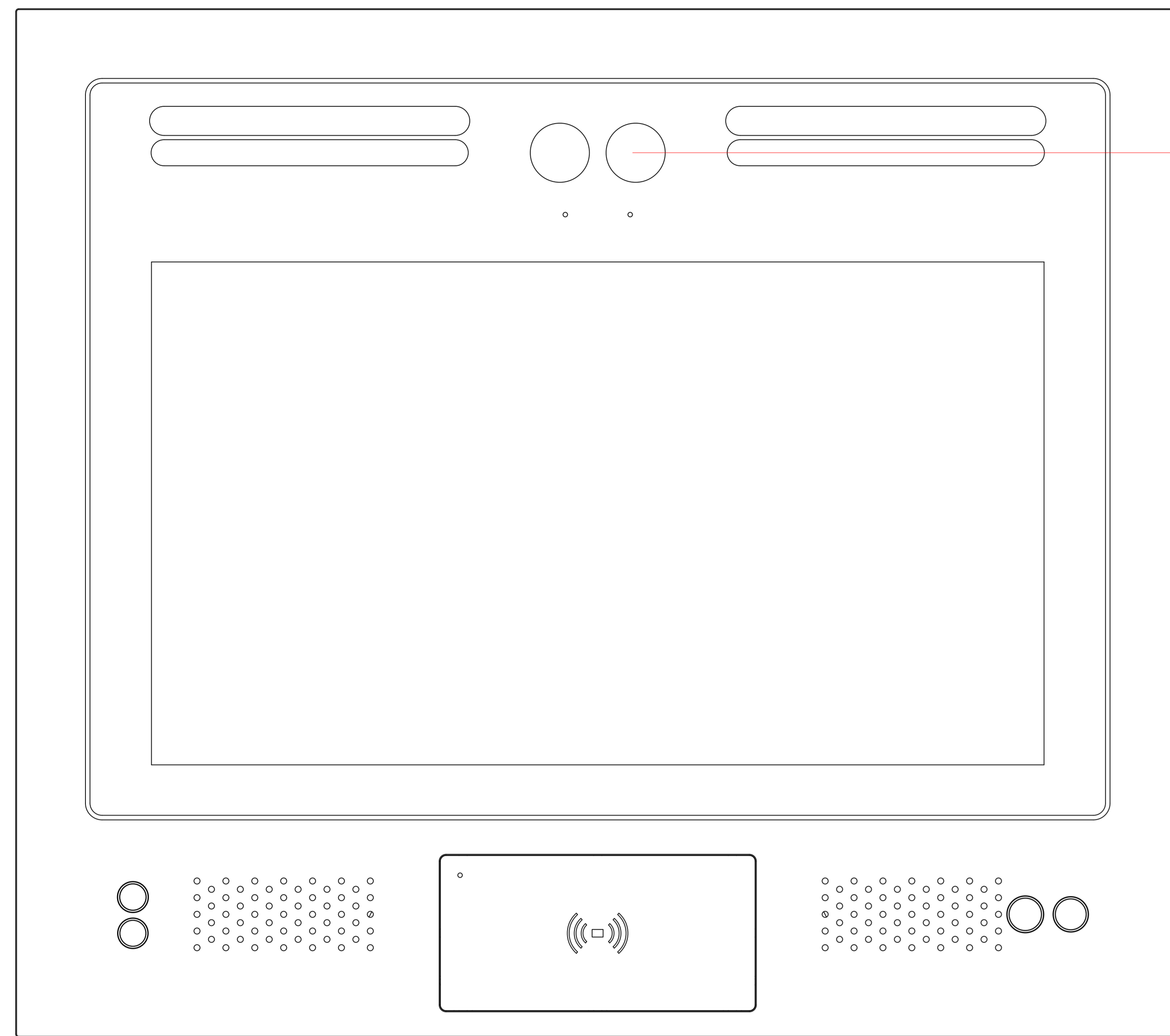

1218mm TO BOTTOM OF PANEL

1500mm TO CENTER OF CAMERA

ADA Compliance Requirement

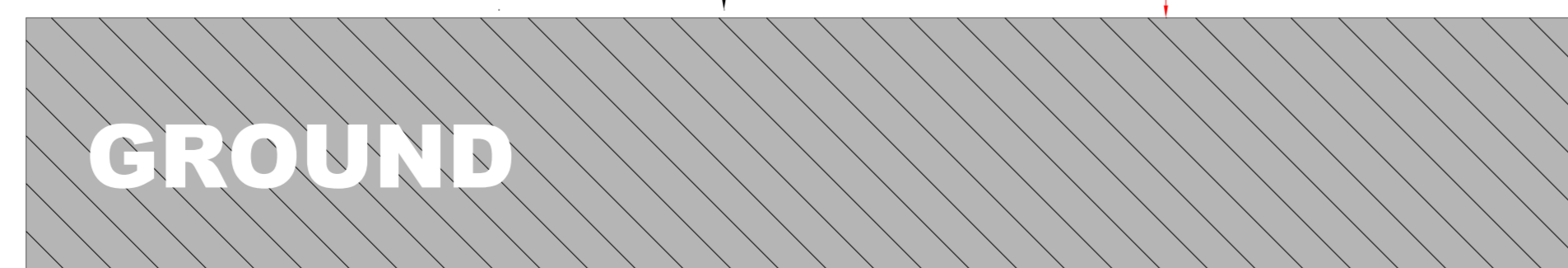

GROUND

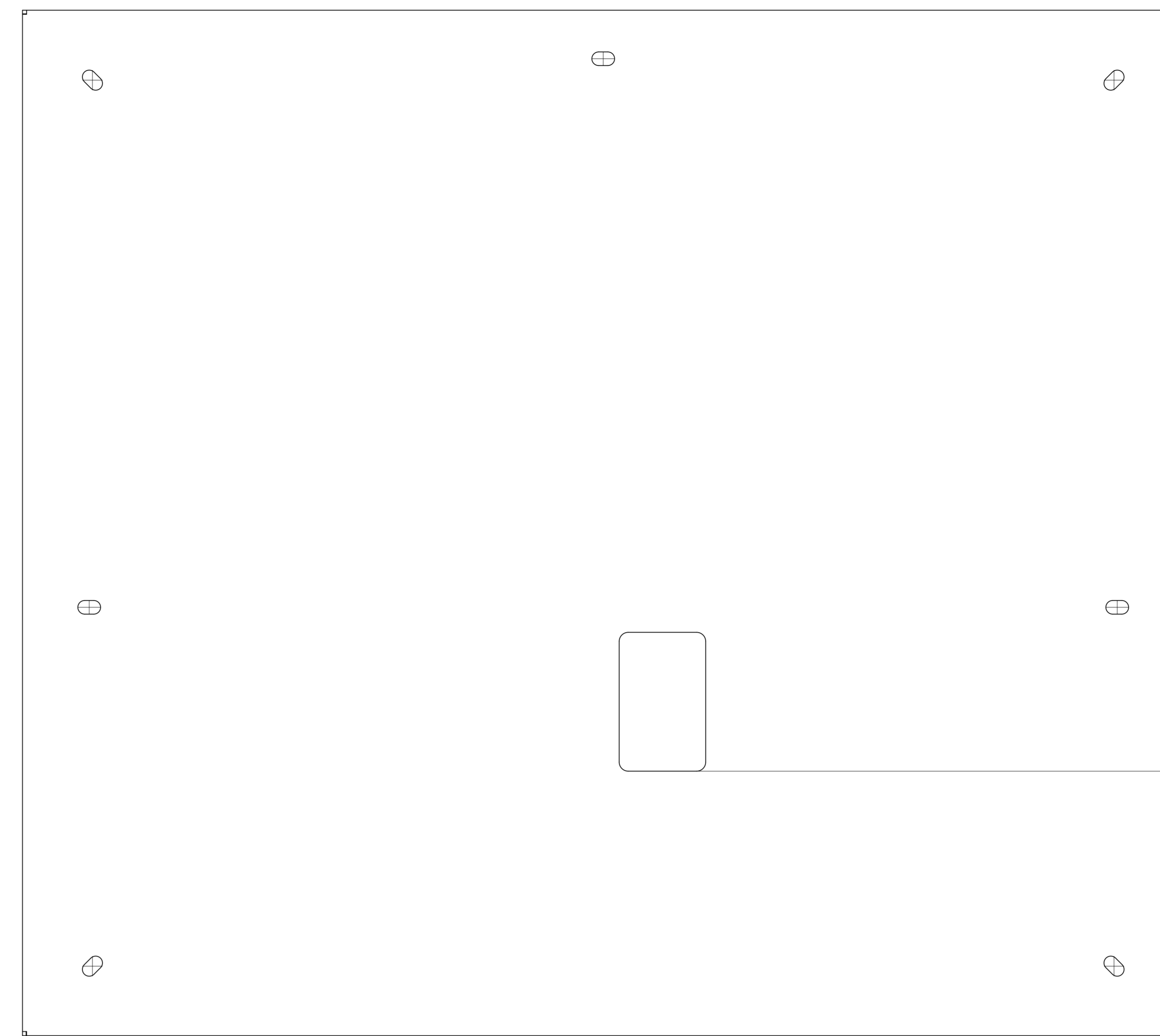

1218mm TO BOTTOM OF BRACKET

1306mm TO HOLE EDGE OF BRACKET

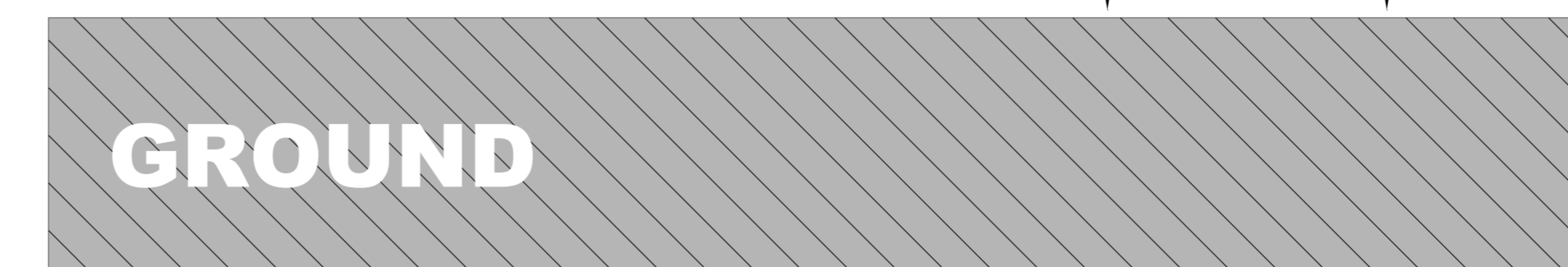

GROUND

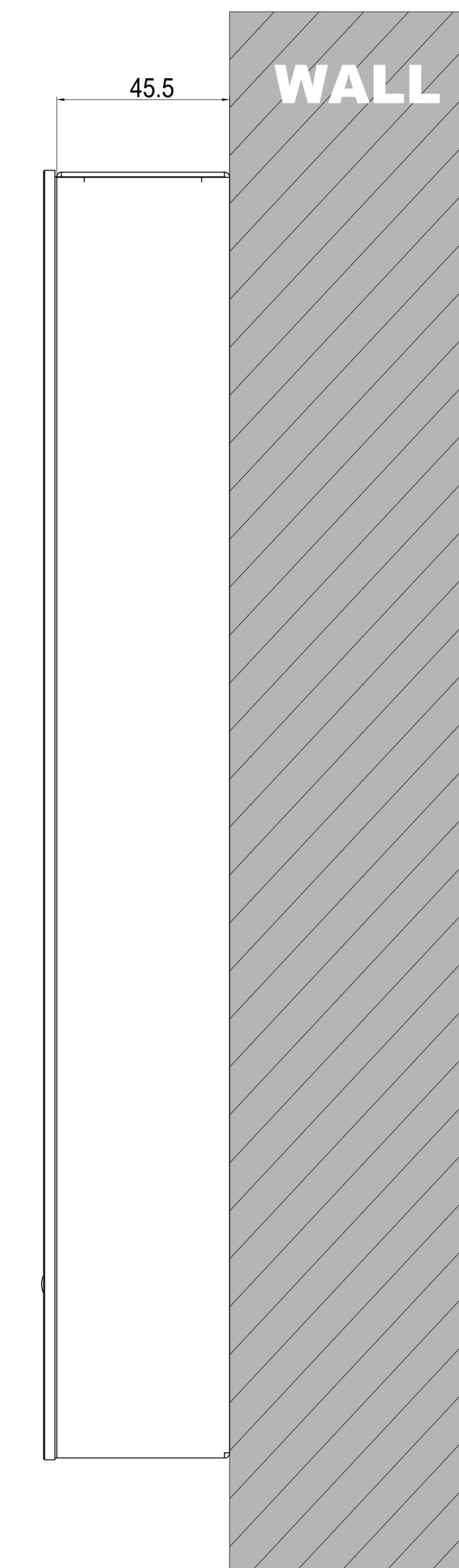

45.5

WALL