

## Unpacking

Before you begin using the device, please check the version you got and ensure that the following items are included in the shipped box:

### Universal Accessories:

---



R20K-2 x 1



Wiring cover x 1



M2.5 x 6 crosshead screw x 8



Rope x 1



Sealing pressing plate x 1



Rubber plug x 3 (S,M,L)



Diode x 1



3 Pin cable x 1



7 Pin cable x 1

### Wall-mounting Accessories :

---



ST4x20 crosshead screw x 4



M4x30 crosshead screw x 2



Allen wrench x 1



Plastic wall anchor x 4



Wall-mounting screw x 4



M3x6 hex socket screw x 4



Wall-mounting bracket x 1



Wall-mounting template x 1

### Flush-mounting Accessories :

---



Flush-mounting box x 1



M4x15 torx head screw x 2

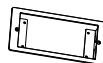

Flush-mounting bracket



ST4x20 crosshead screw x 4



Plastic wall anchor x 4



Torx wrench x 1

## Product Overview

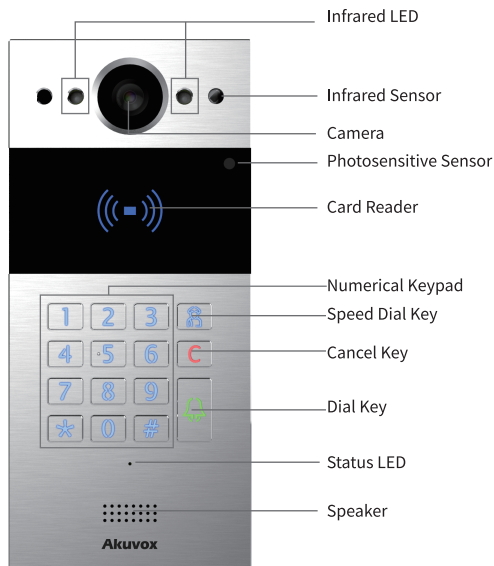

R20K-2

## Installation Environment

Please do not place device under direct sunlight.

If installing the device indoors, please keep device at least 2 meters away from light, and at least 3 meters away from window and door .

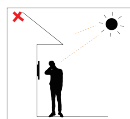

Backlight

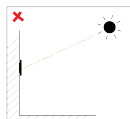

Direct sunlight

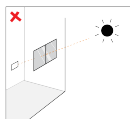

Direct sun through window



Indirect sunlight through window

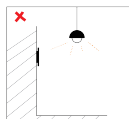

Close to light

## Installation

### On-Wall Mounting

#### Step 1: Wall-mounting Bracket/Box Installation

1. With embedded one-gang junction box (86x86 mm or 2x3 inches in size) in the wall.

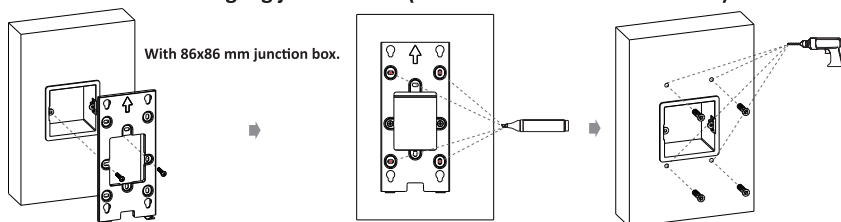

With 86x86 mm junction box.

Fix the wall-mounting bracket on the 86x86mm embedded box with two M4x30 crosshead screws.

Mark the four holes of the wall-mounting bracket on the wall.

Use a hand drill with 6mm diameter bit to drill four screw holes with a depth of 25mm at the marked positions. Then insert four plastic wall anchors into the holes.

or

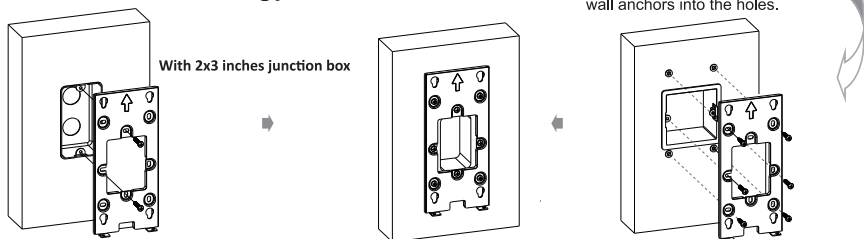

With 2x3 inches junction box

Fix the wall-mounting bracket to the 2x3 inches junction box with two M4x30 crosshead screws.

Finish the wall-mounting bracket installation.

Fix the wall-mounting bracket with four ST4x20 crosshead screws and two M4x30 crosshead screws.

2. Without embedded junction box in the wall

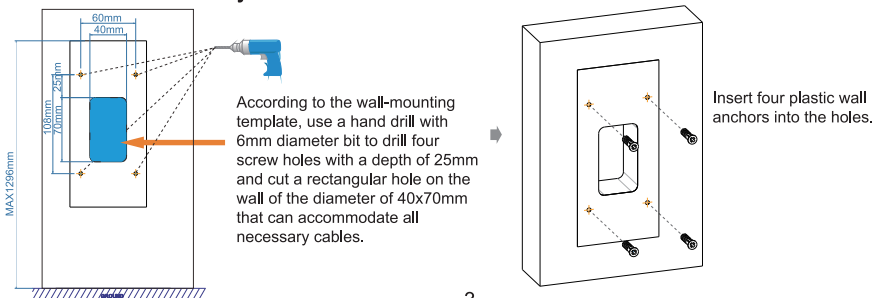

According to the wall-mounting template, use a hand drill with 6mm diameter bit to drill four screw holes with a depth of 25mm and cut a rectangular hole on the wall of the diameter of 40x70mm that can accommodate all necessary cables.

Insert four plastic wall anchors into the holes.

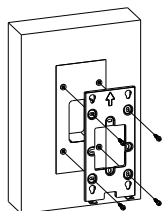

Fix the wall-mounting bracket with four ST4x20 crosshead screws.

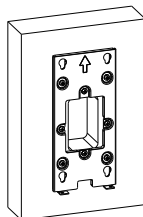

Finish the wall-mounting bracket installation.

## Step2: Wiring Cover Installation

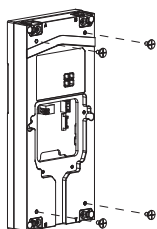

Install four wall-mounting screws to the back of the device.

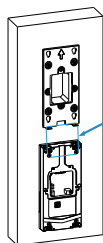

For convenient wiring, hang R20K-2 on the wall-mounting bracket with rope.

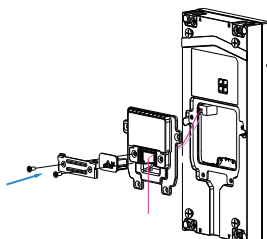

Make cables go through the wiring cover, connecting to the corresponding interfaces of the main board. Select a suitable size rubber plug to push all the cables into the wiring cover. Fix sealing pressing plate to the wiring cover with two M2.5x6 crosshead screws.

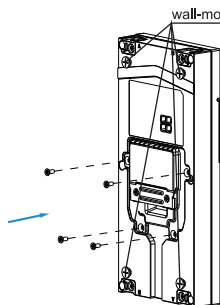

Fasten the wiring cover with four M2.5x6 crosshead screws.

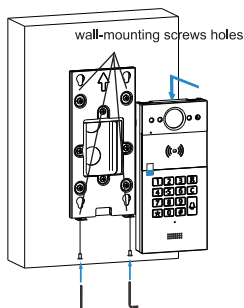

Insert the four wall-mounting screws on the device into the corresponding holes on the wall-mounting bracket, and then press down to slide the wall-mounting screws into the groove. Then use the allen wrench to tighten the device with two M3x6 hex socket screws.

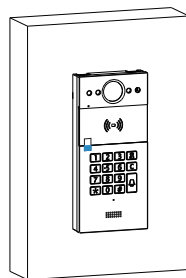

Installation is completed, please remove the protect film.

## Flush-mounting

### Step 1: Flush-mounting Bracket/Box Installation

#### 1. Normal installation

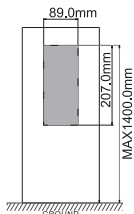

Cut a rectangular hole on the wall (height\*width\*depth=207\*89\*40mm) that can accommodate all the cables.

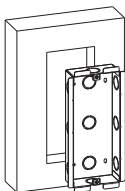

Insert the flush-mounting box into the hole.

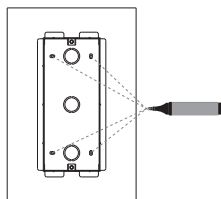

Mark the four holes of the flush-mounting box on the wall.

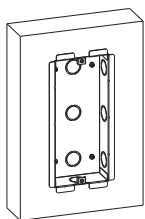

Flush the flush-mounting box installation.

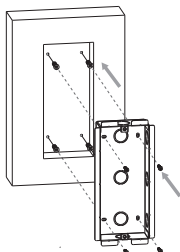

Insert four plastic wall anchors into the holes you drilled before.

Fix the flush-mounting box with four ST4x20 crosshead screws.

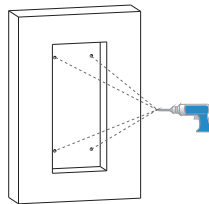

Take down the embedded box, then drill (6mm drill bit required) the four marked fixing holes on the wall with a depth of 25mm.

#### 2. Or you can choose another simple method without fixing ST4x20 screws

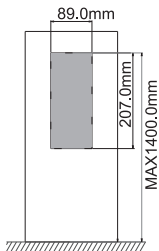

Cut a rectangular hole on the wall (height\*width\*depth=207\*89\*40mm) that can accommodate all the cables.

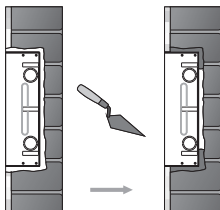

Use cement or non-corrosive structural adhesives to fill the gap between the wall and flush-mounting box. Wait the adhesive material desiccation, go to the next step.

##### Waterproof Tips:

- For flush-mounting installation, it is recommended to fill the gaps around the embedded box for waterproofing (to prevent water from entering the gap in the wiring cover of the door phone).
- For wall-mounting installation, it is recommended to lock the wall-mounting bracket and the wall so that the EVA pasted on the bottom of the wall-mounting bracket is close to the wall without a gap (to prevent water from entering the gap in the wiring cover of the door phone).
- Or it is recommended to use a rain cover.

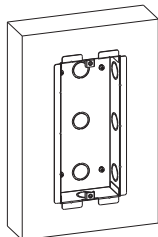

Finish the flush-mounting box installation.

## Step2: Flush-mounting Bracket Installation

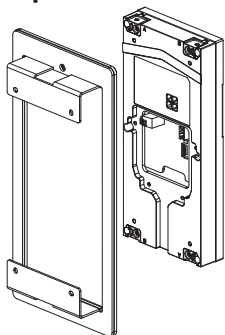

Combine the device with the flush-mounting bracket according to the direction indicated in the drawing.

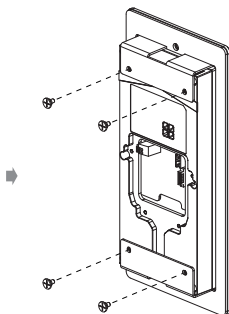

Tighten the device onto the flush-mounting bracket with four wall-mounting screws.

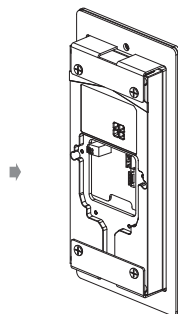

Flush-mounting bracket installation is completed.

## Step3: Wiring Cover Installation

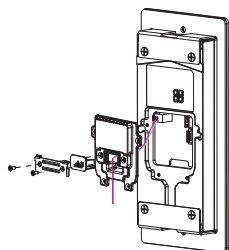
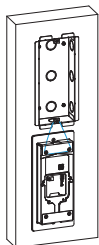

Make cables go through the wiring cover, connecting to the corresponding interfaces of the main board. Select a suitable size rubber plug to push all the cables into the wiring cover. Fix sealing pressing plate to the wiring cover with two M2.5x6 crosshead screws.

Note: In the case of one network cable or less than 6 signal cables, use S-size rubber plugs. In the case of 7 to 10 signal cables, use M-size rubber plugs. When there are more than 11 signal cables, please use L-size wiring rubber plug.

For convenient wiring, hang R20K-2 on the flush-mounting box with rope.

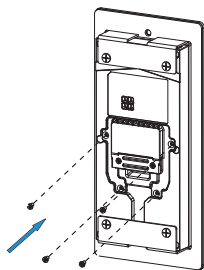

Fasten the wiring cover with four M2.5x6 crosshead screws.

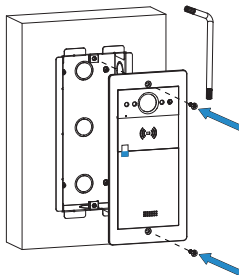

Install the device on the flush-mounting bracket using two M4x15 torx head screws.

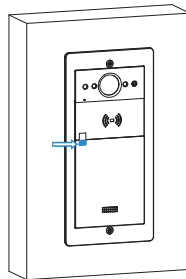

Installation completed, please remove the protective film.

## Device Wiring

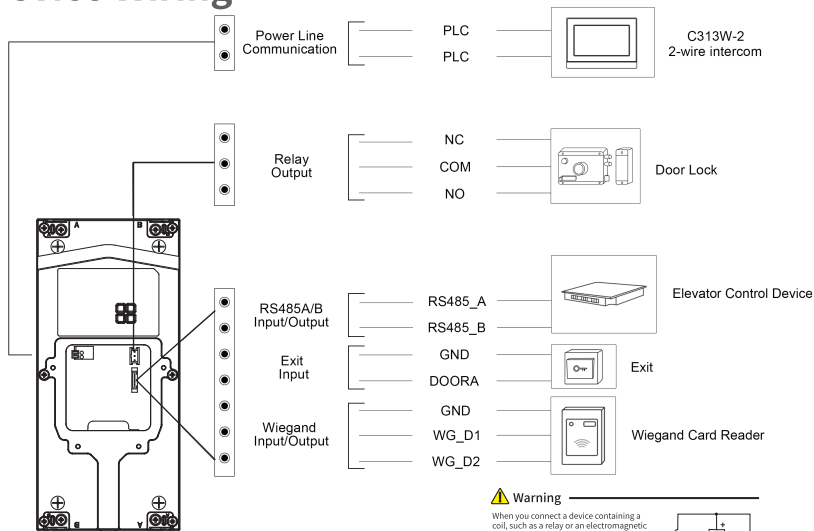

### Warning

When you connect a device containing a coil, such as a relay or an electromagnetic lock, it is necessary to protect the intercom against voltage peak while switching off the induction load. For this way of protection we recommend a diode 1 A / 200 V (included in the accessories) connected antiparallel to the device.

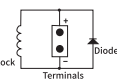

## Application Network Topology

**Topology-1: each device connect to NS-2 separately.**

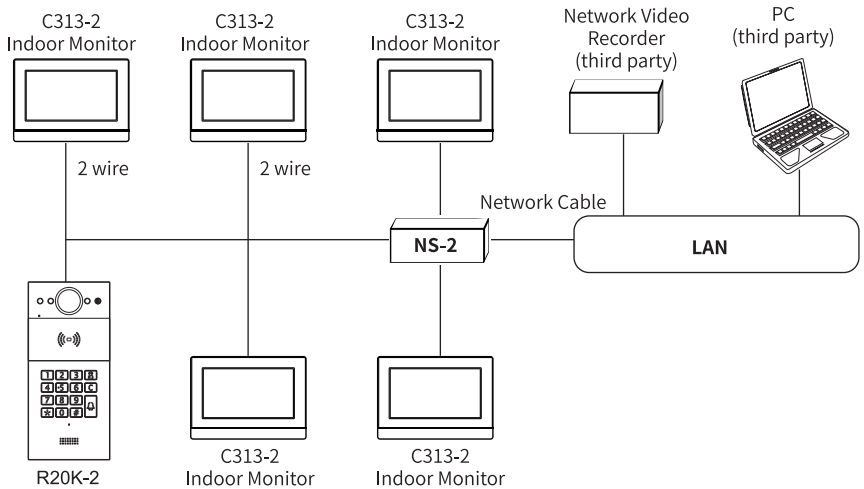

Adapter Voltage	Cable Model	Farthest Distance	Adapter Voltage	Cable Model	Farthest Distance
48V	24awg	300m	24V	24awg	150m
	20awg	300m		20awg	250m
	18awg	300m		18awg	300m



## Topology-2: devices are series connection with NS-2.

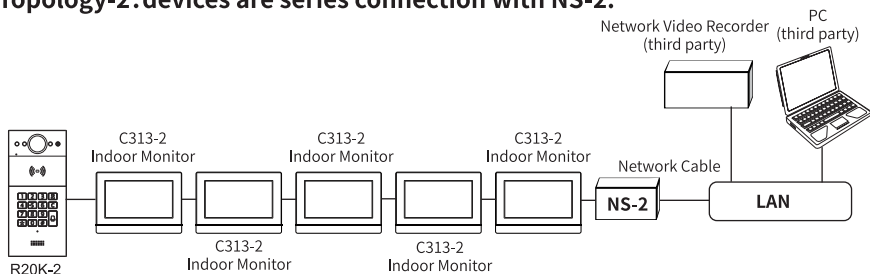

Adapter Voltage	Cable Model	Farthest Distance	Adapter Voltage	Cable Model	Farthest Distance
48V	24awg	100m/6devices	24V	24awg	50m/3devices
		150m/4devices			150m/1device
	200m/3devices	100m/3devices			
48V	20awg	250m/6devices	24V	20awg	150m/2devices
		300m/5devices			250m/1device
48V	18awg	300m/6devices	24V	18awg	100m/6devices
					150m/4devices
					300m/2devices

Note: When using different cable, the maximum number of devices can connect to NS-2 under the different maximum distances which can refer to the above table. For example, when using a 24awg cable, if the farthest distance is 100m, the maximum number of devices connect to NS-2 is 6.

## IP Announcement

1. While R20K-2 starts up normally, press \*3258\*, voice system will enter IP announcement mode.
2. In announcement mode, the IP address will be announced periodically.
3. Press Cancel Button again to quit the announcement mode.
4. In announcement mode, phone announces "IP 0.0.0.0" if no IP address is gained.

## Configuration

1. Access the Web UI: Input the IP address into web browser to configure the phone.
2. Account Registration: On web UI, go to the path: **Account > Basic** page Register Account and fill in the account information. ( Please refer to user manual for more information)
3. Configure the Manager button: On web UI, go to the path: **Intercom > Basic > Manager Dial** to configure the call number.
4. Configure the code to open the relay: On web UI, go to the path: **Intercom > Relay > Relay ID/DTMF** and choose the DTMF code number in corresponding area.

## Operation

### Make a call:

Press the manager button to call indoor SIP Phone.

### Receive a call:







R20K-2 supports Auto Answer by default. Incoming call from indoor device will be answered automatically.

### Unlock:

1. During the talk, called party can press pre-configured code number to unlock the door.
2. Scan the predefined RFID card nearby the card reader to unlock.
3. Press the predefined pin code to unlock.

## Indicators

 Light ON    Light OFF

Name	Status	Description
Status indicator	Blue	 Normal status
		 Calling
	Red	 Network is unavailable /Restarting / Initializing
	Green	 Talking on a call
		 Receiving a call
	Red/Purple	 Firmware upgrading

*Note:* For more LED settings, please refer to R20K-2 webUI: Intercom -> LED Setting.

### Notice Information

Akuvox R20K-2 firmware contains third-party open source software under the terms of the GNU General Public License (GPL). Akuvox is committed to meeting the requirements of the GNU General Public License (GPL) and will make all required source code available.

The source code of software under the terms of GNU GPL can be downloaded online: <http://www.akuvox.com/gpl>.

Information contained in this document is believed to be accurate and reliable at the time of printing. This document is subject to change without notice, any update to this document can be viewed on Akuvox's website: <http://www.akuvox.com> © Copyright 2023 Akuvox Ltd. All rights reserved.



**AKUVOX (XIAMEN) NETWORKS CO., LTD.**

Add.: 10/F, NO.56 GUANRI ROAD, SOFTWARE PARK II, XIAMEN 361009, CHINA  
[www.akuvox.com](http://www.akuvox.com)



YS20000072