

Unpacking

Please make sure the package contains the following items:

Universal Accessories (Please find in device box):



Flush-mounting Accessories :

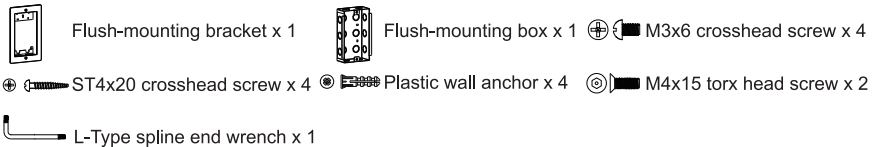

Product Overview



R20A

Installation Environment

Please do not place device under direct sunlight.

If installing the device indoors, please keep device at least 2 meters away from light, and at least 3 meters away from window and door .

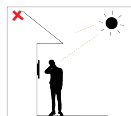

Backlight

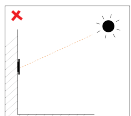

Direct sunlight

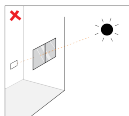

Direct sun through window



Indirect sunlight through window

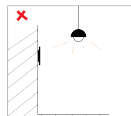

Close to light

Installation

Step 1: Flush-mounting Box Installation

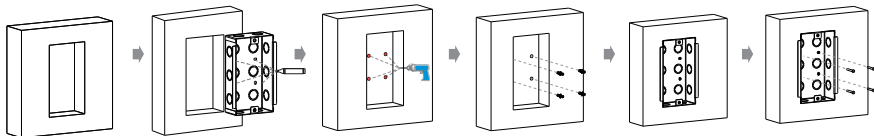

According to the position of the cable, cut a square hole in wall.(height*width*depth=180*101*50 mm).

Note: The size of the hole should be a little larger than recommended value that it can accommodate all needed cables.

Insert the flush-mounting box into the hole and make sure the cables of the device can route through the cable hole then mark the four screw holes of the flush-mounting box on the wall.

Take down the flush-mounting box then use a 6 mm hand drill to make holes with a depth of 25 mm at the marked positions.

Insert four plastic wall anchor into the holes.

Place the flush-mounting box into the square hole until the edges of which align to the wall and make all cables go through the cable hole.

Fix the flush-mounting box with four ST4x20 crosshead screws. Then use cement or non-corrosive structural adhesives to fill the gap between the wall and flush-mounting box.

Or you can choose another simple method without fixing ST4x20 crosshead screw

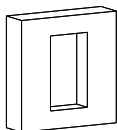

According to the position of the cable cut a square hole in the wall (height*width*depth=180*101*50 mm).

Note: The size of the hole should be a little larger than recommended value that it can accommodate all needed cables.

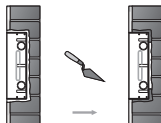

Use cement or non-corrosive structural adhesives to fill the gap between the wall and flush-mounting box. Wait the adhesive material desiccation, go to the next step.

Waterproof Tips:

- For flush mounting installation, it is recommended to fill the gaps around the flush-mounting box for waterproofing (to prevent water from entering the back cover of the door phone from the gap).
- For wall mounting installation, it is recommended to lock the wall-mounted bracket and the wall so that the EVA pasted on the bottom of the wall mounting bracket is close to the wall without a gap (to prevent water from entering the back cover of the door phone from the gap)
- Or it is recommended to use rain cover.

Step 2: Flush-mounting Bracket and Wiring cover Installation

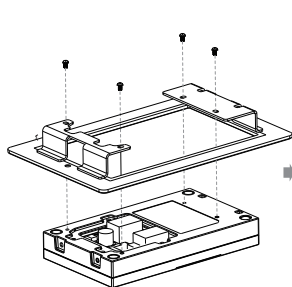

Use four M3x6 crosshead screws to fix R20 on the decorative panel.

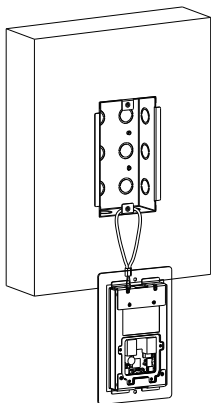

For convenient wiring, hang R20A on the flush-mounting box with rope.

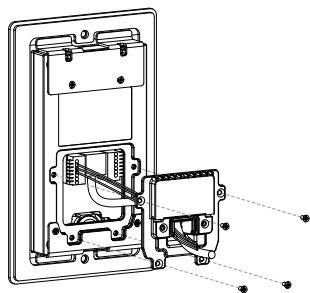

Make cables go through the wiring cover, connecting to the corresponding interfaces of the main board. Fasten the wiring cover with four M2.5x6 crosshead screws.

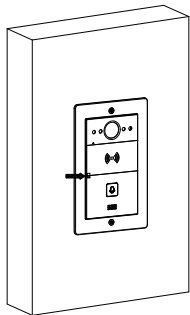

After successful installation, check the stability of device. And remove the protective film.

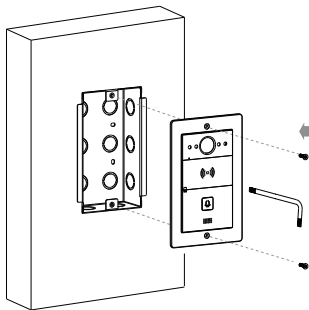

Place the device into the flush-mounting box, then use L-type spline end wrench to tighten the device with two M4x15 torx head screws.

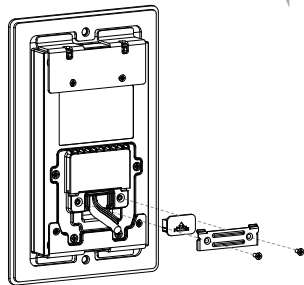

Select a suitable rubber plug to push all cables into to wiring cover. Fix sealing pressing plate on the wiring cover with two M2.5x6 crosshead screws.

Device Wiring

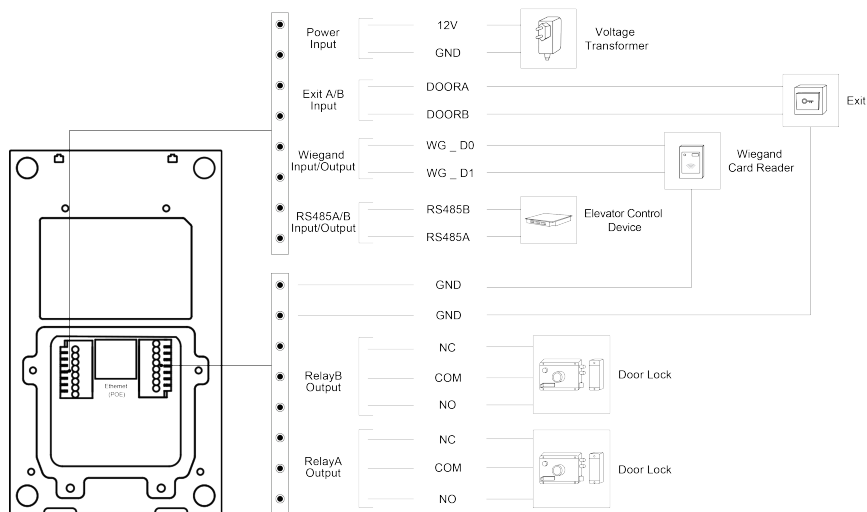

Warning

When you connect a device containing a coil, such as a relay or an electromagnetic lock, it is necessary to protect the intercom against voltage peak while switching off the induction load. For this way of protection we recommend a diode 1 A / 200 V (included in the accessories) connected antiparallel to the device.

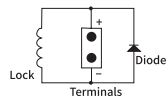

Wire Length & AWG Table

Please follow the properly measured wire gauge/length to install device:

	20 AWG	22 AWG	24 AWG	26 AWG
12V 1A Adapter	≤50m	≤40m	≤20m	\

Application Network Topology

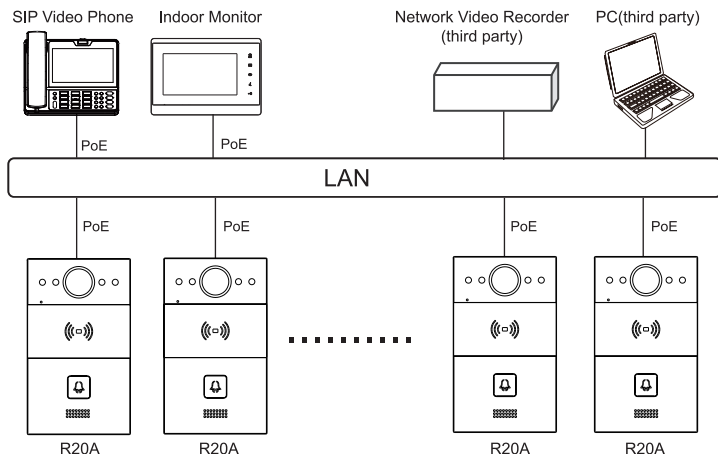

IP Announcement

1. While R20A starts up normally, hold the **Call button** for several seconds after the Status LED turns blue, voice system will enter IP announcement mode.
2. In announcement mode, the IP address will be announced periodically.
3. Press **Call button** again to quit the announcement mode.
4. In announcement mode, phone announces "IP 0.0.0.0" if no IP address is gained.

Configuration

1. Access the Web UI: Input the IP address into web browser to configure the phone.
2. Account Registration: On web UI, go to the path: **Account > Basic** page to register account and fill in the account information. (*Please refer to admin guide for more information*)
3. Configure the Push Button: On web UI, go to the path: **Intercom > Basic > Push Button** to configure the call number.
4. Configure the code to open the relay: On web UI, go to the path: **Intercom > Relay > Relay ID/DTMF** and choose the DTMF code number in corresponding area.

Operation

Make a call:

Press the **Call button** to call indoor SIP Phone.

Unlock:













During the talk, called party can press pre-configured DTMF code to unlock the door.

Receive a call:

R20A supports Auto Answer by default. Incoming call will be answered automatically.

Indicators

 Light ON  Light OFF

Name	Status	Description
Status indicator	Blue	 Normal status
		 0.25sec →  0.25sec
	Red	 0.05sec →  0.05sec
		 0.25sec →  0.25sec
	Green	 Initialing/Talking on a call
		 0.25sec →  0.25sec
Red/Blue	 0.05sec →  0.05sec	

Note: For more LED settings, please refer to R20A webUI: Intercom > LED Setting.

Notice Information

Akuvox R20A firmware contains third-party open source software under the terms of the GNU General Public License (GPL). Akuvox is committed to meeting the requirements of the GNU General Public License (GPL) and will make all required source code available.

The source code of software under the terms of GNU GPL can be downloaded online: <http://www.akuvox.com/gpl>.

Information contained in this document is believed to be accurate and reliable at the time of printing. This document is subject to change without notice, any update to this document can be viewed on Akuvox' s website: <http://www.akuvox.com> © Copyright 2023 Akuvox Ltd. All rights reserved.



AKUVOX (XIAMEN) NETWORKS CO., LTD.

Add.: 10/F, NO.56 GUANRI ROAD, SOFTWARE PARK II, XIAMEN 361009, CHINA
www.akuvox.com

