

TRAILER IDENTIFICATION PLATES – FOR TRAILERS PRODUCED SINCE SEPTEMBER 2012

Your trailer will have two or three identification plates which are typically attached to the right hand side of the drawbar. These plates contain important information including the trailers serial number (also known as VIN number) and its max gross weight.

For trailers produced on or before Sept 2012, there will still be a VIN Plate, which carries the serial number in the same format as the new trailers. (There may not however be a Drawbar approval plate fitted)

STANDARD EC APPROVAL VIN PLATE

1	EC approval number	1
	VIN Number	2
	Gross vehicle weight	3
	Permissible mass on a single axle	4
	Permissible mass on a double axle	5
	Permissible mass on a triple axle	6
	Internal description	7

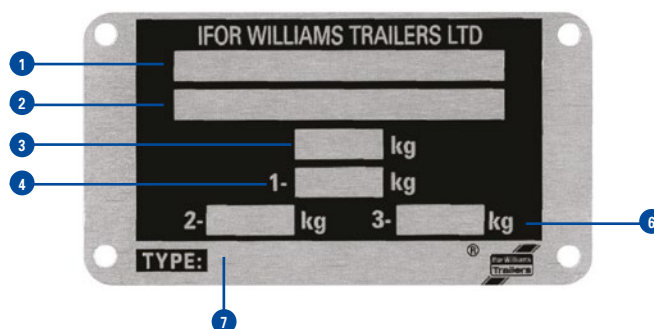

DRAWBAR APPROVAL PLATE

2	Trailer manufacturer	1
	Trailer model	2
	Drawbar variant code	3
	Maximum gross weight that can be fitted to this model of drawbar	4
	Theoretical horizontal reference force	5
	Max static load	6
	EC approval number	7

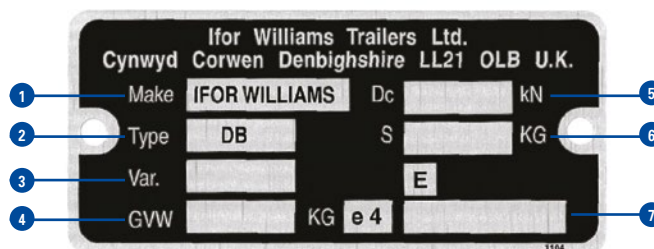

DOWN RATED TRAILER WEIGHT VIN PLATE

(Occasionally trailers are down rated (normally if the driver has not got B1 and E) towing entitlements. If it has been downrated this plate will be present.)

3	EC down-rated approval number - Country specific	1
	VIN Number	2
	Gross vehicle weight	3
	Permissible mass on axle 1	4
	Permissible mass on axle 2	5
	Internal description	6

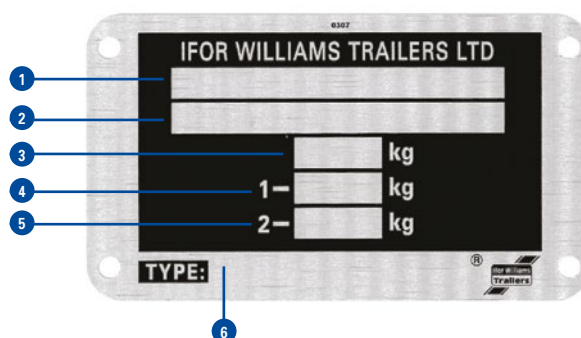

When ordering certain types of spare parts you will need to supply us with the serial number of the trailer. This identifies the age and batch reference of the trailer, which informs us of any changes to product specification around the date of manufacture. If you are ordering spares for more than one trailer, you will need to identify which serial number the parts are intended for.

HOW TO FIND YOUR SERIAL NUMBER

Every trailer we manufacture is fitted with a type plate (plate 2 – Standard EC approval VIN plate), this will have a unique serial number printed on it by multi-dot punching. An example of a standard type plate is shown opposite. All Ifor Williams Trailers serial numbers begin with the prefix SCK. This example is printed with the full 17 digit VIN (Vehicle Identification Number). The last 6 or 7 digits represent the serial number depending on the age and model of your trailer. Some models may be fitted with a slightly smaller plate; however, the serial number will still be present and easily recognisable.

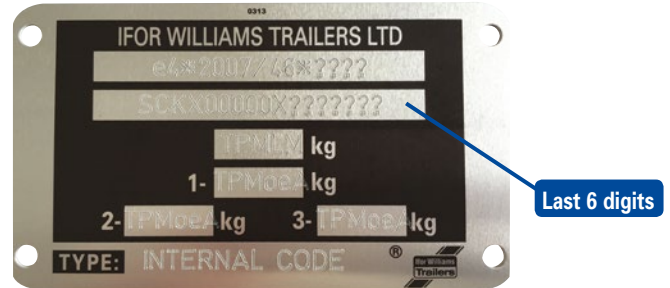

BRAKED TRAILERS

For trailers with 'A Frame' drawbars the plate is located on the outside of the right hand drawbar member. On trailers with adjustable height couplings the plate is located on the right hand section of the supporting structure that the drawbar/coupling unit is clamped to.

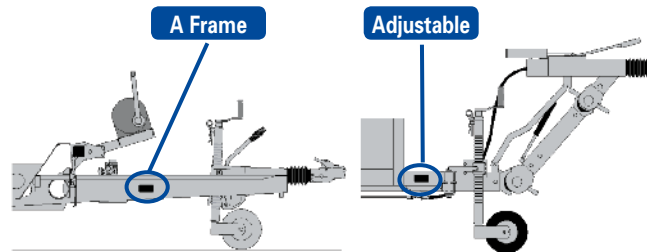

UNBRAKED TRAILERS

On P5/6/7e/8e (unbraked) models the plate is fitted to the front panel of the trailer, or is sometimes attached to the drawbar mounting bracket. On BV64e boxvan models the plate is fitted to the right hand side of the rear cross member.

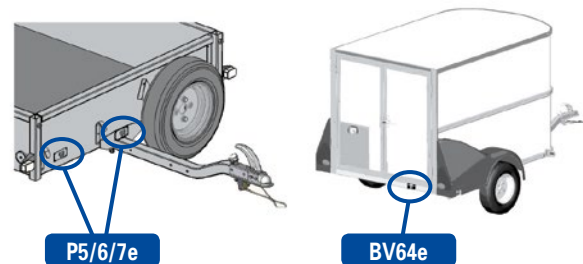

HB403 – SINGLE HORSEBOX

Unlike all other horsebox models, the HB403 has its plates fitted to the outer face on the right hand side directly below the front ramp.

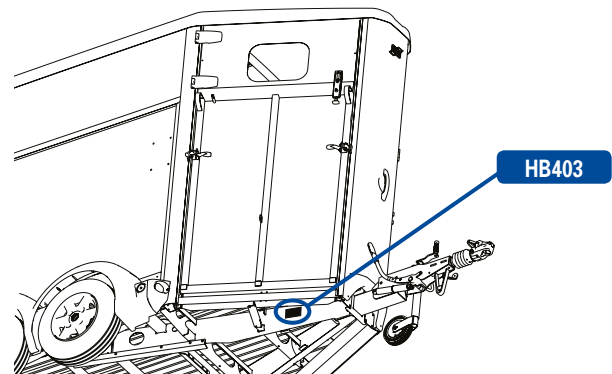

IDENTIFYING COUPLING TYPES

The coupling units fitted to your Ifor Williams trailer may be from one of several different manufacturers, when ordering spares for a coupling or brake linkage it is important to identify the manufacturer and model. Typically an overrun (brake control) coupling unit will be fitted with its own type plate, usually on the top or side of the main shaft housing. The example shown here is from Knott KF13 overrun coupling.

