



EQUIPMENT, RACKS, STORAGE, ACCESSORIES

Product catalog

"Our mission is to make, not only Sweden, but the world healthier and more sustainable."

- Kari Jernvall

Founder and Product Designer



Welcome!

Welcome to Gymleco - a Swedish, family owned business with a passion for health, innovation and sustainability. Gymleco is today the biggest designer and producer of strength training equipment in Northern Europe. We offer a complete line of strength training and exercise equipment, and are one of few in the Nordics producing our products by ourselves. We want our customers to see us as a total solution and a profitable investment.

Since 1994 Gymleco has focused on designing Swedish, unique and functional equipment with a long lifespan and without maintenance needs. At Gymleco we are truly passionate about wellness and hope that you want to join us in achieving our dream of a healthier world and a sustainable future.

Why choose Gymleco?

- Swedish brand founded in 1994
- Made by experience
- NO maintenance
- Quality materials
- Small footprint
- Suitable for all users
- Ergonomically correct
- Affordable quality

CONTENT



Content



About Gymleco

3-4



Assistance / Warranty

5-6



Accessories

Dumbbells, Barbells, Weight Plates etc.

7-34



Calisthenics / Strongman / Functional Fitness

35-46



Gymleco Worldwide,

Distributors

47-50



Gymleco 1994

Aims for a sustainable future

It all started 1994 in a small kitchen, south of Stockholm in **Sweden**, with the idea of providing the market with affordable, functional and sustainable fitness equipment. The ambition was to develop maintenance free strength training equipment with high functionality and quality. The equipment would be borne by the muscle throughout the movement, without a negative impact on the joints.

The goal has always been to offer sustainable equipment that our customers can have at their gyms for decades, and now we are here. We have customers who have equipment left from the 90's - *still going strong*.

Since the start, we have focused on designing unique and functional equipment with a long lifespan and without maintenance needs. We truly believe in our own sustainable design and construction, with other words: products for a sustainable future.



Gymleco now

Still going strong

Today we are located in the capital of Sweden, in Stockholm. Under the same roof you can find the head office, production, warehouse and showroom. This gives us the opportunity to have control all the way from order to shipment and therefore work customer-focused with excellent communication.

With our own manufacturing we can shorten the delivery time, and it also provides an opportunity for you as a customer to order custom-made and customized solutions that are not in the ordinary product range

Gymleco is family owned and we strive every day closer to our vision of a healthier and sustainable future. We stand behind the product development and create our Swedish equipment with proper function and movement combined with ease of use.

Everyone should be able to workout correctly with Gymleco's exercise equipment. That is why our products are designed so that the movements are proper. This to help you get more out of your workout whether you are a beginner or an athlete. Anyone can use our machines. They are both easy to understand and to use.



Assistance at Gymleco

You can certainly fix everything yourself, but you don't need to. At Gymleco, we help you with everything from planning to installation. When you are thinking about choosing your gym equipment, you will receive advice and help from our specialists. Together, we review your needs and wishes to find a solution that fits.



Ideas and planning

Our staff can help you with planning, designing, floor plans for both small and large gyms. We help you find smart and sustainable solutions that strengthen your business.



Delivery

We offer fast delivery home or to your company. We deliver worldwide. Together we plan the delivery so that it suits you.



Assembly and installation

We can help you with the installation of your gym equipment. We will find out all the conditions before installation and when it is time we come and put everything together and in place according to your wishes.

Warranty

Warranty - ISO-9001

Gymleco's unique warranty ensures that your training equipment always works. We can guarantee that our equipment is designed and manufactured with the goal of high performance combined with maintenance free operation. In order to maintain a top tier performance, Gymleco follows the ISO-9001 insurance system.

We offer a unique warranty that clearly defines coverage for various equipment parts. All of our spare parts are kept ready and available for quick delivery. A lifetime warranty is provided on all steel frames and weldings, large bearings, engraving, bar hangers and cam shaft. The lifetime guarantee excludes fabrication and material errors.

One year warranty on cushions.

ISO-9001 Quality Insurance System

At Gymleco we work in accordance with the ISO Quality Insurance System in order to maintain control and improve all production simultaneously as changes are implemented. This coordination allows the manufacturing process to be more efficient and delivers a better product to customers.

The goals of ISO-9001 are as follows: superior quality, accurate delivery, best price, quick production and service. All Gymleco products are produced in-house which allows us to maintain the production and quality.

We take pride in all of our products as we strive to provide the finest gym equipment on the market.



Accessories

We have a wide range of high quality accessories. We design and develop our products to ensure every detail meets our requirements for design, material and durability.

We strive to provide the best accessories for all athletes and gym users. Our comprehensive assortment includes among other things; barbells, dumbbells, benches, racks, weight plates, handles and belts.

Additionally we offer accessories for fitness classes, such as stretching mats and resistance bands. All of our products are designed to withstand heavy use.

Read more about each product on our website:
www.gymleco.com

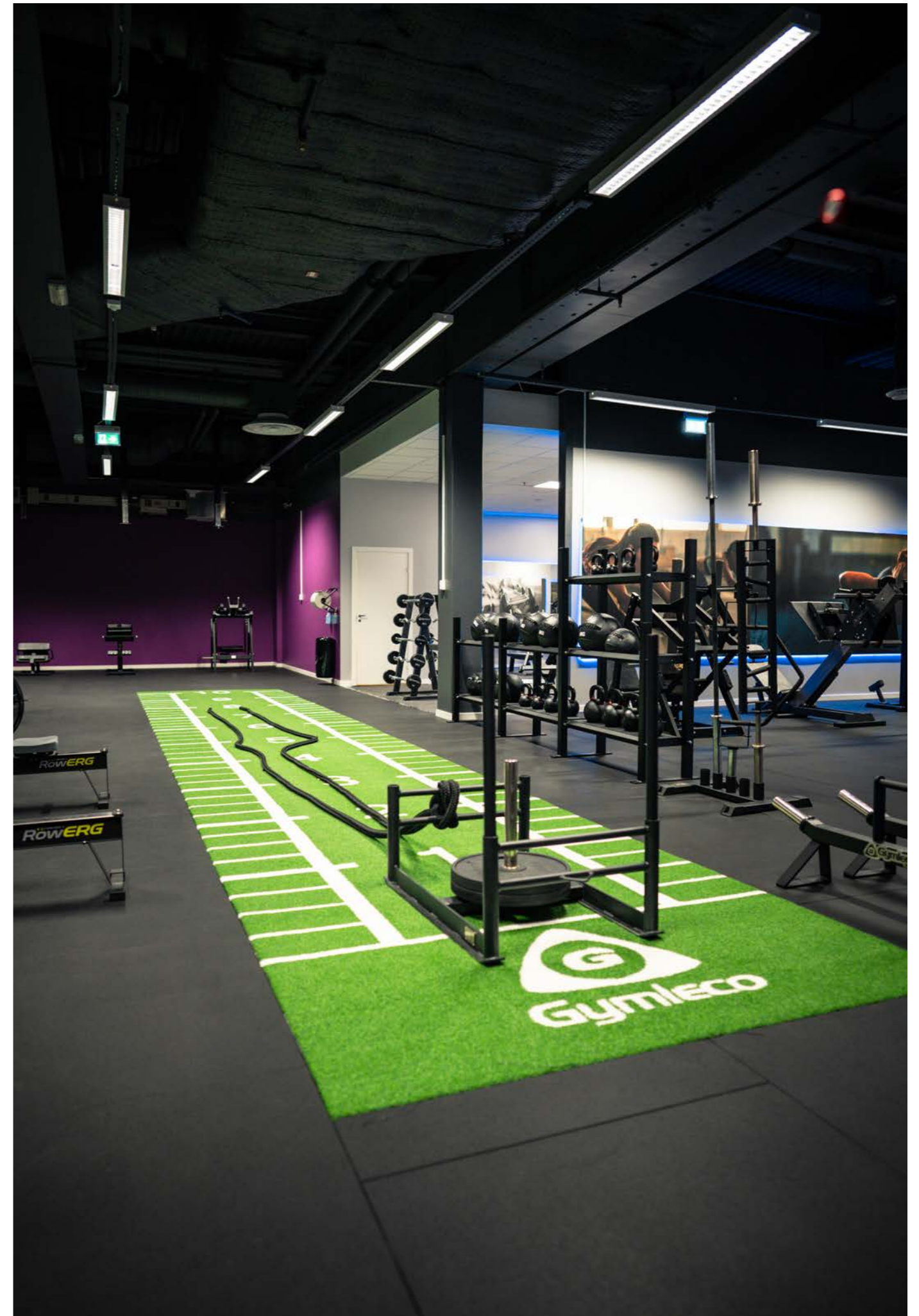

Gymleco Open Deadlit Bar, 11,5 kg /+320 kg
Art.nr: 408



Gymleco International Bar, 20 kg /+320 kg
Art.nr: 410

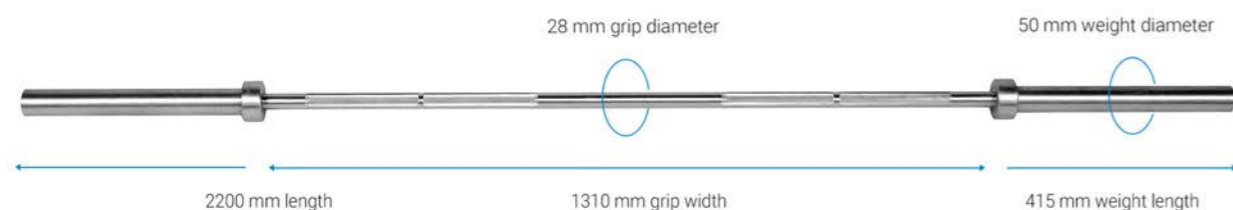

Gymleco Competition Powerlifting Bar, Black, 20 kg /+900 kg
Art.nr: 411



Gymleco Compact Bar 200 cm, 17 kg /+320 kg
Art.nr: 412



Gymleco International Triceps Bar, Double Grip 12 kg /+320 kg
Art.nr: 413



Gymleco Competition Powerlifting Bar, 20 kg /+900 kg
Art.nr: 414

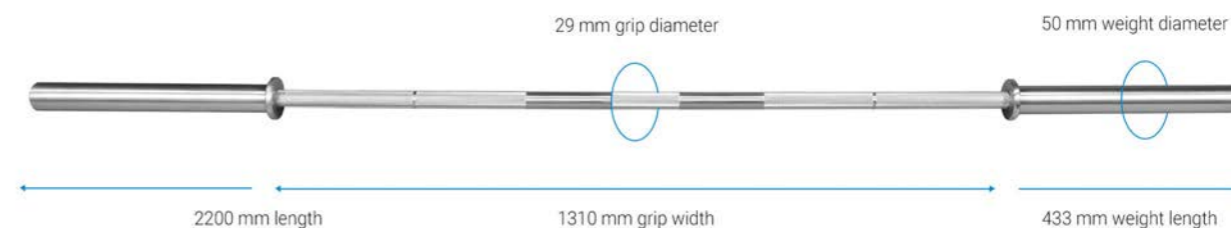

Gymleco Squat Bar 20 kg /+680kg
Art.nr: 414S



Gymleco International Curl Bar, 8,5 kg /+320 kg
Art.nr: 415

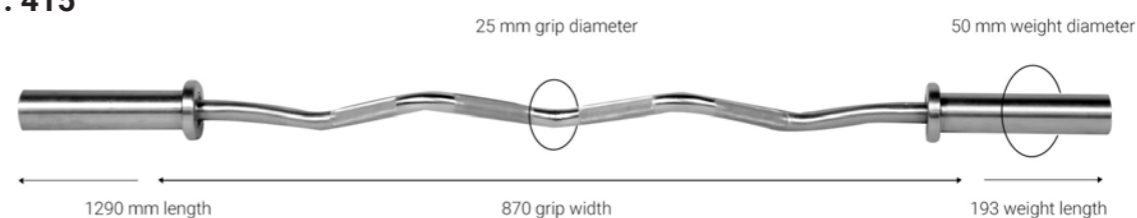

Gymleco International Curl Bar, S-Shape, 8,5 kg /+320 kg
Art.nr: 415S



Gymleco Supra Curl Bar, Biceps & Triceps 10,4 kg / +150 kg
Art.nr: 415Q



Gymleco International Lady Bar 153 cm, 13 kg / +320 kg
Art.nr: 416

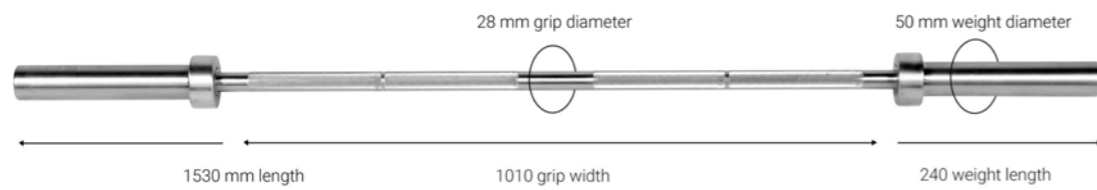

Gymleco Compact Workout Bar 170 cm, 11 kg / +320 kg
Art.nr: 417

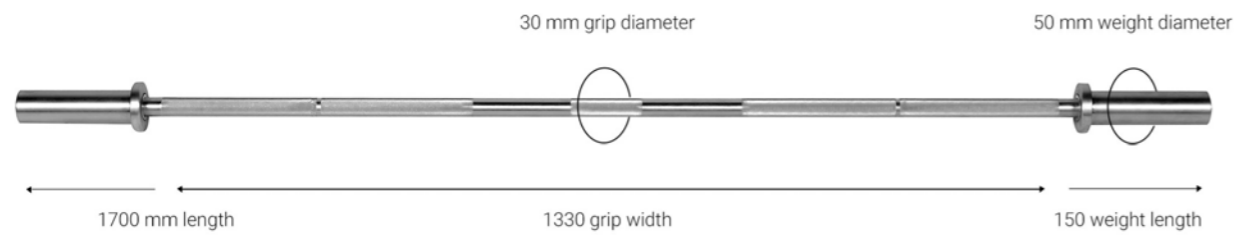

Gymleco Hex Bar, 22,5 kg / +250 kg
Art.nr: 418

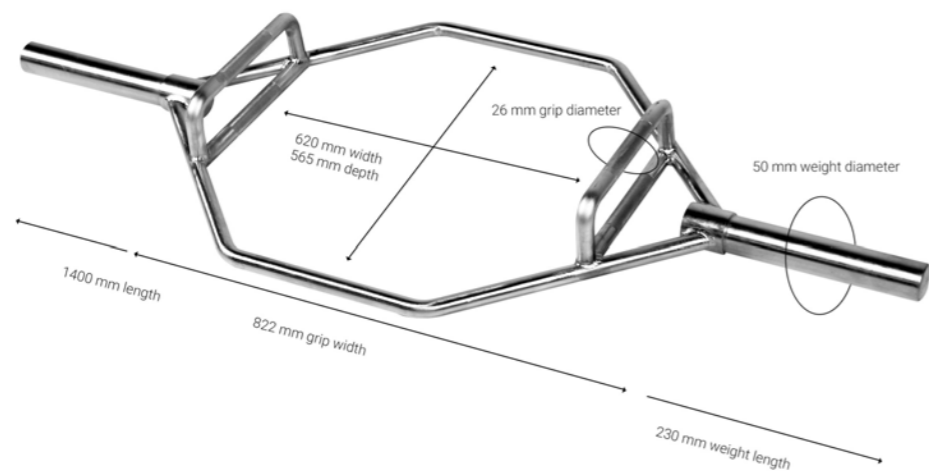

Gymleco International Curved Bar, 20 kg / +680 kg
Art.nr: 419



Gymleco Cross Hybrid Bar, 20 kg / +800 kg
Art.nr: 808



Gymleco Cross Bar, 20 kg / +800 kg
Art.nr: 810

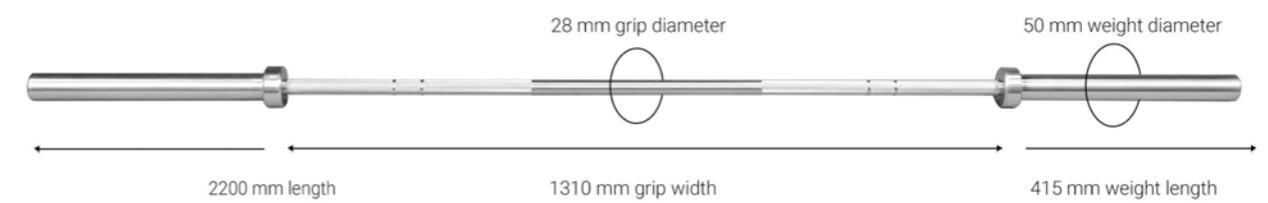

Gymleco Competition Bar, 20 kg / +900 kg
Art.nr: 810C

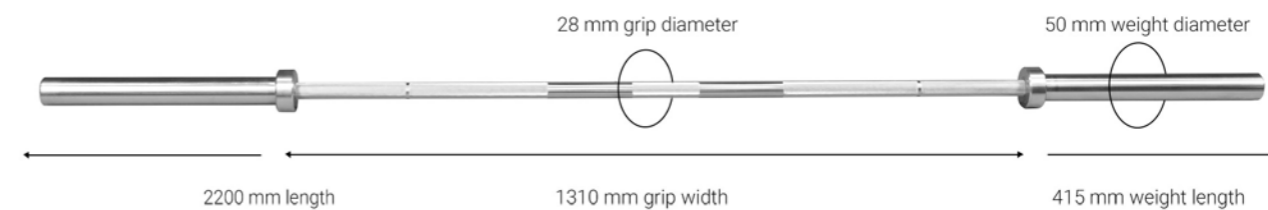

Gymleco Ceracote Cross Bar, 20 kg /+800 kg
Art.nr: 810CR

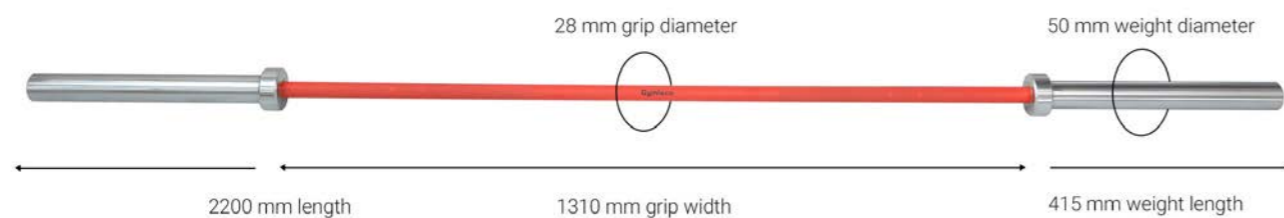

Gymleco Cross Bar Women, 15 kg /+600 kg
Art.nr: 812

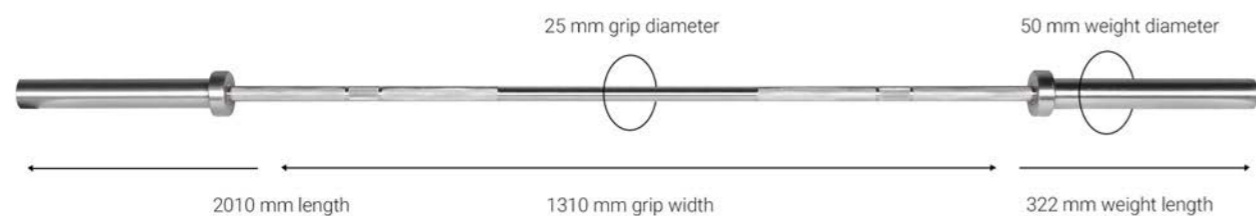

Gymleco Competition Bar 15 kg /+600 kg
Art.nr: 812C

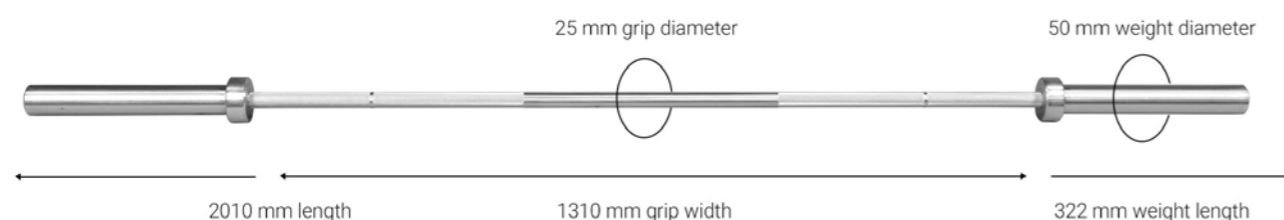

Gymleco Ceracote Cross Bar Women, 15 kg /+600 kg
Art.nr: 812CR

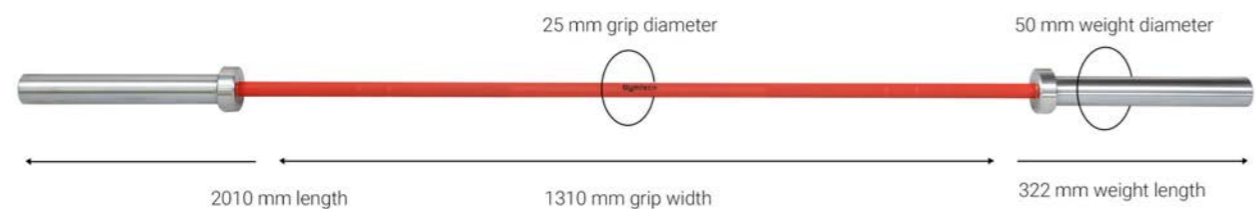

Gymleco Technique Bar, 10 kg /+40 kg
Art.nr: 813

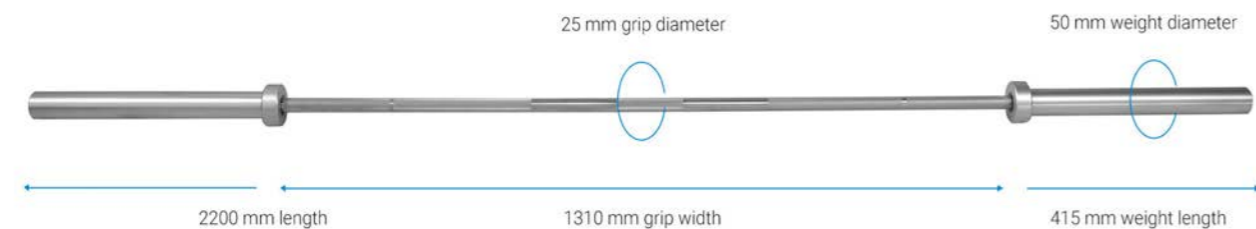

Gymleco Bend Bar, 20 kg /+400 kg
Art.nr: 814

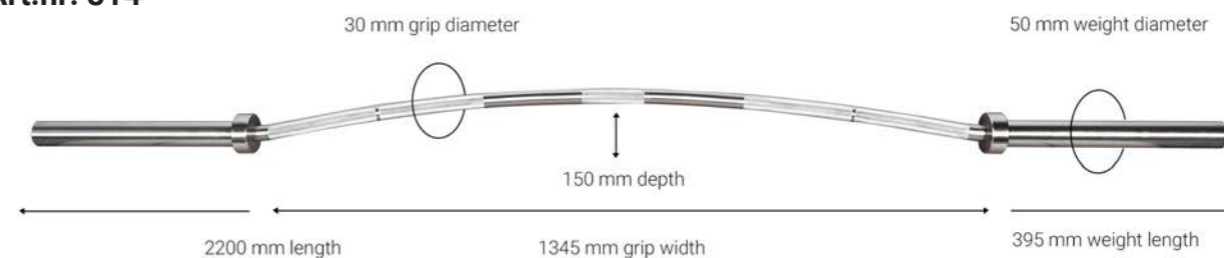

Gymleco Fat Bar, 8 kg /+300 kg
Art.nr: 817

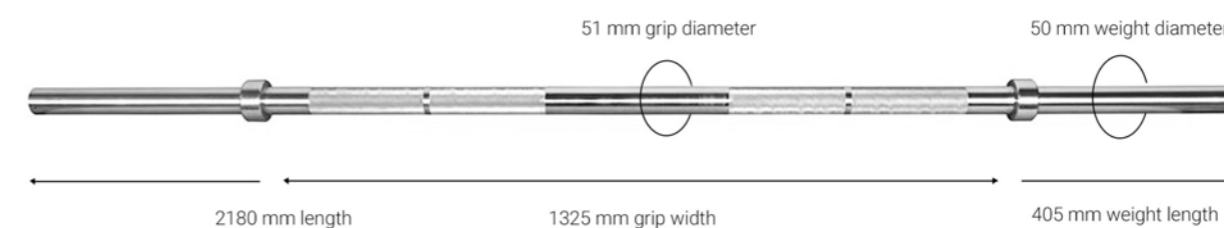

Gymleco Compact Premium Technique Bar 1,7m, 10 kg /+600 kg
Art.nr: 817T

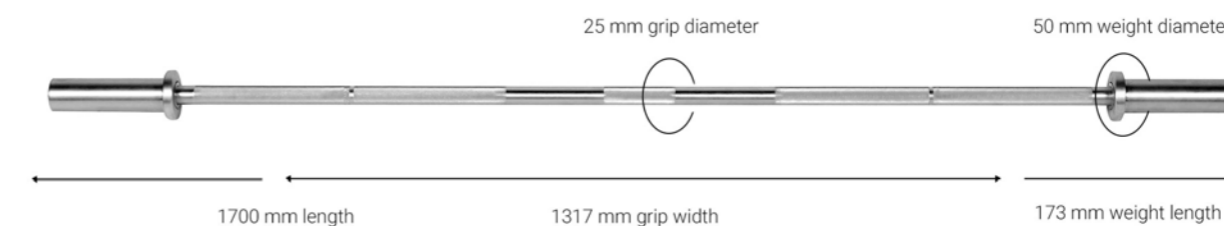

Gymleco Safety Squat Bar, 30 kg /+400 kg
Art.nr: 818



Gymleco Multi Grip Bar, 20 kg /+400 kg
Art.nr: 819



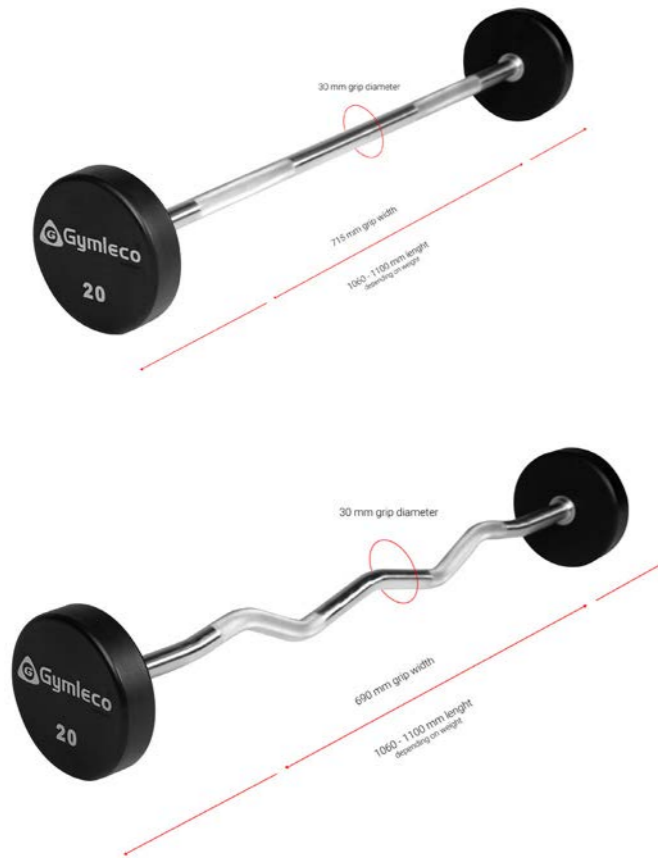

Gymleco Solid Rubber Bars PU,
straight or curved
Art.nr: 825

Gymleco's fixed barbells are designed in a classic, timeless design and are covered in polyurethane material. Polyurethane is similar to strong rubber and thus gives a long life to the barbells. Suitable for the commercial gyms.

Available in sizes:
7,5 to 30 kg with a 2,5 kg weight increase in between and from 30 kg to 50 kg with a 5 kg weight increase in between.



Gymleco Fractional Urethane Plates
Art.nr: 824F

These small weights are excellent for small weight changes in your workout and color coded for easy identification. Premium urethane provides unmatched durability and will not damage the bar.

Hole diameter 50mm
Available in sizes: 0,5kg | 1kg | 1,5kg | 2kg | 2,5kg | 5kg



Gymleco Technique Weight Plates
Art.nr: 824T

Gymleco technique weights in a unique mixture between plastic & rubber provide long durability and quiet use. Extra wide base provides good stability, perfect for training all types of technique lifting.

Hole diameter 50mm
Available in sizes: 2,5 kg | 5kg

Gymleco Iron Kettlebells
Art.nr: KET

We introduce qualitative kettlebells in iron material, with color markings. Weights and grip diameters based on the original dimensions. Double handles of all sizes. Weight marking in both KG and LB.

Available in sizes: 4 kg to 56 kg.



Gymleco Competition Kettlebells
Art.nr: KETC

Kettlebells with one hand grip. Durable dumbbells made of cast iron with comfortable grip. Stylish and high quality kettlebells. Available in several sizes. Color marking on each kettlebell. Measure of the kettlebell does not change even if the weight does.

Available in sizes: 8 | 12 | 16 | 20 | 24 | 32 kg



Gymleco Pump Set, 20 kg
Art.nr: 480-20

Are you looking for a space saving barbell with weights? Then we have the solution for you! A barbell set with a total of 20 kg consisting of a barbell, a pair of spring collars and black rubber weights: 2 x 1,25 kg, 2 x 2,25 kg and 2x 5 kg. 10 kg weights are available to add in the set.

Hole diameter: 31 mm
Bar diameter 30 mm



Gymleco Pump Set PU, 20 kg
Art.nr: 480PU-20

Here is a barbell set perfectly made for group classes at the gym. The weights are of polyurethane material and therefore sustainable. The set is in total 20 kg and consists of a barbell, a pair of spring collars and weights: 2 x 1,25 kg, 2 x 2,25 kg and 2x 5 kg.

Hole diameter: 31 mm
Bar diameter 30 mm





Gymleco Training Weights, Black
Art.nr: 824B

Gymleco weight plates are made of commercial quality, with a diameter of 450 mm and a strong reinforced steel center in the middle. Perfectly suitable for the gymcenter, functional fitness box or the commercial homegym.

Hole diameter 50mm
 Available in sizes: 5kg | 10kg | 15kg | 20kg | 25kg

Gymleco Weight Plates with handles
Art.nr: 423

Gymleco's weight plates are made of high quality rubber and have a good design suited for any commercial gym. These weight lifting plates have handles for easy change of weights when working out.

Hole diameter 50 mm
 Available in sizes: 1,25kg | 2,5kg | 5kg | 10kg | 15kg | 20kg | 25kg



Gymleco Training Weights, Colored
Art.nr: 824C

Gymleco weight plates are made of commercial quality, with a diameter of 450 mm and a strong reinforced steel center in the middle. Perfectly suitable for the gymcenter, functional fitness box or the commercial homegym.

Hole diameter 50mm
 Available in sizes: 5kg | 10kg | 15kg | 20kg | 25kg

Gymleco Weight Plates with handles
Art.nr: 422

Gymleco's weight plates are made of high quality rubber and have a good design suited for any commercial gym. These weight lifting plates have handles for easy change of weights when working out.

Hole diameter 50mm
 Available in sizes: 1,25kg | 2,5kg | 5kg | 10kg | 15kg | 20kg | 25kg



Gymleco Bumper Plates, Black
Art.nr: 824H

Gymleco's Training Bumpers are made of recycled, vulcanised rubber. These bumpers are designed for hard weight training.

Thanks to their soft rubber they're sound-absorbing and durable. This makes the bumpers some of the toughest on the market. Fantastic shock absorbing when you lift!

Hole diameter 50mm
 Available in sizes: 5kg | 10kg | 15kg | 20kg

Gymleco Weight Plates, Polyurethane
Art.nr: 822

Gymleco's international weight plates with handles, enhanced with the markets strongest material (polyurethane) that is similar to strong rubber. These weights from Gymleco are inspired by our most popular weight plates, article 423.

They are of the highest quality and made for commercial use in the gym. The plates have handles for easy switch between machines. Unlike bumper plates these weights are hard which doesn't make them "bumpy".

Hole diameter 50mm
 Available in sizes: 1,25kg | 2,5kg | 5kg | 10kg | 15kg | 20kg | 25kg



Gymleco Steel Dumbbells

Art.nr: 838

Gymleco's new, unique steel dumbbells. Really robust weights that can stand hard weight training. No loose detail or surface treatment that can loosen or flatten. That makes the dumbbells extremely durable.

Available in sizes:
5kg | 7,5kg | 10kg | 11kg | 12kg | 12,5kg | 13kg | 14kg | 15kg | 16kg | 17kg | 17,5kg | 18kg | 19kg | 20kg | 22,5kg | 25kg | 27,5kg | 30kg | 32,5kg | 35kg | 37,5kg | 40kg | 42,5kg | 45kg | 47,5kg | 50kg | 52,5kg | 55kg | 57,5kg | 60kg | 65kg | 70kg | 75kg | 80kg and up to 100 kg at request.



Gymleco Dumbbells, PU

Art.nr: 836

These dumbbells are made of the highest commercial quality and covered in polyurethane material. Durable dumbbells with a well-thought-out design. All weights come with clear markings and with no risk of weights becoming loose.

Grip diameter 30mm (applies for dumbbells in sizes 5-27,5kg)
Grip diameter 34mm (applies for dumbbells in sizes 30-80kg)
Handle length: 150mm

Available in sizes:
5kg | 7,5kg | 10kg | 11kg | 12kg | 12,5kg | 13kg | 14kg | 15kg | 16kg | 17kg | 17,5kg | 18kg | 19kg | 20kg | 22,5kg | 25kg | 27,5kg | 30kg | 32,5kg | 35kg | 37,5kg | 40kg | 42,5kg | 45kg | 47,5kg | 50kg | 52,5kg | 55kg | 57,5kg | 60kg | 65kg | 70kg | 75kg | 80kg



Gymleco Hex Dumbbells, 12,5-35 kg

Art.nr: 433

These dumbbells are made of the highest commercial quality, delivering a durable dumbbell with a well-thought-out design. All weights come with clear markings and with no risk of weights becoming loose.

Available in sizes:
12,5 kg | 15 kg | 17,5 kg | 20 kg | 22,5 kg | 25 kg | 27,5 kg
30 kg | 32,5 kg | 35 kg



Gymleco Dumbbells 1-10 kg, PU

Art.nr: 835

Gymleco's dumbbells are manufactured with durable material called polyurethane. Each weight comes with clear markings and comfortable handles.

Available in sizes:
1 kg | 2 kg | 3 kg | 4 kg | 5 kg | 6 kg | 7 kg | 8 kg | 9 kg | 10 kg

Gymleco Hex Dumbbells 1-10 kg

Art.nr: 433

These rubber hex dumbbells deliver the perfect balance of quality and price to any athlete. The dumbbells are hexagonal shaped and stop the weights from rolling around.

Available in sizes:
1 kg | 2 kg | 3 kg | 4 kg | 5 kg | 6 kg | 7 kg | 8 kg | 9 kg | 10 kg

Gymleco Chrome Dumbbells 1-10 kg

Art.nr: 430

These highly reflective and attractive dumbbells add a touch of class to any gym. These chrome dumbbells are ergonomically designed to fit comfortably in the users hand.

Available in sizes:
1 kg | 2 kg | 3 kg | 4 kg | 5 kg | 6 kg | 7 kg | 8 kg | 9 kg | 10 kg

Gymleco Premium Chrome Dumbbells 1-10 kg

Art.nr: 830

These high commercial chrome dumbbells are made of steel and can not be unscrewed. This makes them sustainable at the commercial gym.

Available in sizes:
1 kg | 2 kg | 3 kg | 4 kg | 5 kg | 6 kg | 7 kg | 8 kg | 9 kg | 10 kg

R101



R102



R103



R106



R107



R108



R108R



R4076



R112



R112L



R845



R115



R117



108Q



117Q



R118



R120



R122



R122R



R123



R141N



R847



R847N



R402



R408



R250



763



761-1,5x6



765



764



R403



R405



R404



A-713



A-712



N42-118



N42-PRO



A-Abmat



R427



R849



A-714



N61236



N61-226



A-715M



N951-26



A-1506008



A-BAL



R482N



A-082Belt -S/M/L



N62-657



N62-657



N68-723



N59-996



N68-726



N61369



A-ABROLL



R110



F121

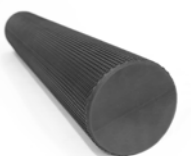

751 - G/B



N38 - 8 / 12 / 16



N62-657



N62-656



816



N32-903



Foam Plyo Box Art.nr: N59995-60

When you are a new athlete and do not have experience in box jumps, there is often a fear of injury while doing the movement. Even advanced athletes can, despite their away-trained fears, choose soft plyo boxes as they reduce the chance of being injured further.

Length: 76 cm
Width: 61 cm
Height: 51cm
Weight: 47 kg



Wooden Plyo Box Art.nr: N59993

Gymleco's Wooden Plyo Box is a training tool with 3 heights in one box. Turn over the box and get three different heights. The Plyo box is made of wood and with handles for easy movement of the box. The box is stable and safe for performing box jumps and other training exercises with a focus on resilience, balance and explosiveness.

Length: 76 cm
Width: 61 cm
Height: 51cm
Weight: 22 kg



Wooden Plyo Box, Premium Art.nr: 680

Gymleco's Premium Plyo Box is a training tool with 3 heights in one and the same box. Turn the box over and get three different heights. The Plyo box is made in Sweden from 18mm WISA Hexagon material and designed with handles to easily move the box away.

Length: 76 cm
Width: 61 cm
Height: 51cm
Weight: 24,6 kg



Slam Balls Art.nr: 788

Gymleco's Slamballs gives you the opportunity for a variety of functional exercises and thanks to the fact that we have developed Slamballs in various sizes you can adjust your weight on the Slamball according to your ability and wishes.

Available in sizes:
2kg | 4kg | 6kg | 8kg | 10kg | 12kg | 15kg | 20kg | 25kg | 30kg
35kg | 40kg | 45kg | 50kg | 55kg | 60kg | 70kg | 80kg | 90kg | 100kg



Wall Balls Art.nr: 789

Gymleco's Wall Balls are designed in strong and robust quality. Made for heavy weight training and functional fitness at both boxing and commercial gyms. Also suitable for Strongman training.

Available in sizes:
2kg | 3kg | 4kg | 5kg | 6kg | 7kg | 8kg | 9kg | 10kg | 11kg | 12kg | 14kg



Gymnastic Balls, 3 sizes Art.nr: A-D55, A-D65, A-D75

Gymnastic Balls or Yoga Balls, as they are also called, are great for strength training and training your balance and coordination. You can do a variety of different exercises with the Yoga Balls and they are a must in the big commercial gyms as well as a great addition in your home gym.

Available in sizes 55 cm, 65 cm and 75 cm



Gym Balance Trainer Ball Art.nr: N85

Gymleco Balance Trainer is a commercial half-ball that is a well-regarded tool in the gym. A new and unique training method, which makes it possible to combine aerobic, muscle and torso training.

Included: Pump and handles



Weight Rack with 2 barbell holders
Art.nr: 895

Length: 46,5 cm
 Width: 61 cm
 Height: 133 cm

Weight: 15,5 kg



Weight Rack with 8 Placements
Art.nr: 196

Length: 50 cm
 Width: 46,5 cm
 Height: 125 cm

Weight: 13,5 kg



Weight Rack with 6 Placements
Art.nr: 195

Length: 50 cm
 Width: 46,5 cm
 Height: 155 cm

Weight: 16 kg



Weight Rack, Wall Mounted
Art.nr: 197

Length: 50 cm
 Width: 46,5 cm
 Height: 155 cm

Weight: 12 kg



Dumbbell Rack
Art.nr: 440

Length: 227 cm
Width: 58 cm
Height: 79 cm
Weight: 45 kg



Rack for 5 dumbbell pairs
Art.nr: 440F-1200

Length: 120 cm
Width: 62 cm
Height: 62 cm
Weight: 40 kg



Rack for 10 dumbbell pairs
Art.nr: 440F-2400

Length: 240 cm
Width: 62 cm
Height: 62 cm
Weight: 73,5 kg



Rack for 10 Barbells
Art.nr: 451V

Length: 80 cm
Width: 77 cm
Height: 15 cm
Weight: 24,5 kg



Rack for 5 Barbells
Art.nr: 452V

Length: 63 cm
Width: 71 cm
Height: 15 cm
Weight: 12 kg



Barbell Holder, 2 places
Art.nr: 472

Length: 30 cm
Width: 20 cm
Height: 13 cm
Weight: 3,5 kg



Dumbbell Rack for 5 pairs
Art.nr: 840-5

Length: 115 cm
Width: 58 cm
Height: 62 cm
Weight: 41 kg



Dumbbell Rack for 10 pairs
Art.nr: 840

Length: 230 cm
Width: 58 cm
Height: 62 cm
Weight: 67 kg



Dumbbell Rack 10 pairs
Art.nr: 441

Length: 32,5 cm
Width: 32 cm
Height: 126 cm
Weight: 15,5 kg



Barbell Storage, 10 places
Art.nr: 451

Length: 65 cm
Width: 46 cm
Height: 15,5 cm
Weight: 25 kg



Barbell Storage, 5 places
Art.nr: 452

Length: 65 cm
Width: 40 cm
Height: 15,5 cm
Weight: 20 kg



Barbell Holder, 5 places
Art.nr: 475

Length: 66 cm
Width: 20 cm
Height: 13 cm
Weight: 7,6 kg



Rack for bodypump weights and barbells
Art.nr: 480

The smart design makes it easy to storage 30 sets of pump weights and barbells on this rack. This is the perfect rack and storage for the group training area.

Length: 80 cm
Width: 115 cm
Height: 152 cm
Weight: 51 kg

Kettlebell Rack, 2 tiers
Art.nr: 443

Gymleco kettlebell Rack that can fit up to 10-15 kettlebells depending on kettlebell size. Very stable and flexible design with rubberized shelves for quiet and safe management. Can also be used as a stand for slam balls, wall balls, etc.

Length: 55 cm
Width: 125 cm
Height: 70 cm
Weight: 32,5 kg



Rack for 10 Barbells
Art.nr: 450H

Well-designed barbell rack for fixed barbells in straight or curled model. Clean and beautiful with a black frame and hangers in chrome. The barbell storage is designed for commercial use and is the-refor suitable for professional gyms.

Length: 89 cm
Width: 88 cm
Height: 138 cm
Weight: 60,5 kg

Handle Carriage
Art.nr: 495

Gymleco has the solution for optimal handle storage in the gym. This handle trolley with double accessory boards on both sides gives you extremely good storage of all kinds of pull handles and accessories in the gym. You can easily move it around at the gym thanks to the wheels.

Length: 130 cm
Width: 50,5 cm
Height: 131 cm
Weight: 65,5 kg



Rack for 5 Barbells
Art.nr: 445H

Well-designed barbell rack for fixed barbells in straight or curled model. Clean and beautiful with a black frame and hangers in chrome. The barbell storage is designed for commercial use and is the-refor suitable for professional gyms.

Length: 89 cm
Width: 88 cm
Height: 138 cm
Weight: 37 kg

Accessory board with 14 placements
Art.nr: 495-1

This accessory board from Gymleco takes up to 14 different pull handles, training accessories, belts etc. Thanks to the timeless and classic design, the handle board can be easily to place to the gym next to cable machines and multigyms.

Length: 130 cm
Width: 50,5 cm
Height: 131 cm
Weight: 18 kg





Dip Handles, wall mounted'
Art.nr: 755D

Gymleco's wall mounted dips handles are well thought out in design and form. The angled handles give you the right position for your dip training. Well suitable for the big gym or the smaller homegym



Dip Handles, individual arms, wall mounted
Art.nr: 755S

Gymleco's wall mounted individual dip handles are incredibly well constructed and strong. Easily to train dips and the design is surface-smart because of space-saving. Well suitable for the big gym or the smaller homegym.



Barbell Rack, wall mounted
Art.nr: 446

This horizontal wall mounted barbell rack offers convenient storage for 6 different barbells. Effective when you want to free up some space around your rack or on the floor and have the barebells on the wall instead.

Rack for Gym balls, wall mounted
Art.nr: 465

Gymleco's wall mounted rack for gymnastic balls are in a classic and compact design so that you can easily place it on the gym. Suitable for balls with size D45-80 cm.



Mat Suspension
Art.nr: 446

Gymleco's adjustable mat hanger. Perfect for hanging Gymleco's Hygienic Mat on. Perfect for both the group gym where there is a need for organizing your yoga mats or at the home gym where you want the mats hanged neatly on the wall.



Mat storage, single hook
Art.nr: 461

Gymleco's mat hanger with one hook, perfect for hanging Gymleco's Hygienic Mat with one eyelet. Perfect for the gym or at the home gym when you want the mats hanged neatly on the wall.



Wallball Target, Double
Art.nr: 689

Wallball target is used in functional training when you throw a weighted ball to the target area.

Suitable for Gymleco racks with art.no: 601, 602, 649 & 848. Can also be wall mounted. Heights: Men 305cm c/c, Ladies 274cm c/c Diameter 40cm.





Power Rack, Big

Art.nr: 649

This Power Rack is excellent for squats, bench press and chins training, among other things. The rack is designed with safety frames that makes it easy for both the beginner and the experienced weightlifter to use the rack.

2 reversible chin bars included: D25mm + D40mm
Safety barriers included.

Length: 82 cm
Width: 122 cm
Height: 240.5 cm
Weight: 158 kg



Half Rack

Art.nr: 848

This one-sided Half Rack is a well designed rack with the possibility of a large number of exercises such as bench press, squats, chins, pull-ups, standing rowing, etc. A robust rack designed for commercial gyms.

Safety barriers 500mm included.

Length: 116 cm
Width: 164 cm (with weight holder)
Height: 230 cm
Weight: 101 kg



Half Rack Double Sided

Art.nr: 848D

Half Rack in double model is a great rack with the possibility of an extremely large number of exercises such as bench press, squats, chins, pull-ups, standing rowing, etc. Easy to place on the gym thanks to the compact design. Commercial quality for the professional gym.

Safety barriers 500mm included.

Length: 202.7 cm
Width: 164 cm (with weight holder)
Height: 230 cm
Weight: 180 kg



Wallmounted Rig
Art.nr: 601

This wallmounted Gymleco rig, or so-called training station for functional fitness, is a beautiful and stable rig for all gym environments. It is multifunctional with the possibility of many different training exercises such as squats and chins. The rig is designed and made by Gymleco and is therefore created with quality materials.

The rig is attached to the wall and has a number of extensions that you can add on as well as various options for building the rig bigger.



1.

Included:
 2 pc bar hangers
 Chins bar at 33,7 mm in diameter



2.

Included:
 Weight holder, pair with 4 + 4 weight places
 Security console



3.

Image shows how you can build out the rig with two sections with a chinbar at 130 cm between

Rig with 6 liftings places
Art.nr: 602

This rig from Gymleco has both low and high pillar positions so that you can integrate rope and ring stations as desired. The stand has a total of 11 pull-up stations, of which six are suitable squat stations. It can be equipped with accessories such as dip racks, safety equipment, weight racks, etc.

Height: 271 cm (You can also build a lower one if necessary)
 Height highest part: 346 cm
 Width: 122/142/182 cm, you can choose different widths depending on space.



Complete Crossbox Station
Art.nr: 610

Crossbox station from Gymleco provides versatile training for the whole body and the station can be built with complementary accessories completely according to your own conditions and wishes. You can for example build your station with additional parts such as a monkey bar, punching bag and squat suspension.

Length: 345 cm
 Width: 245 cm
 Height: 236 cm



Monkey Bar Rig
Art.nr: 614

The purpose of a Monkey Bar Rig is to, among other things, practice grip strength by getting from one side to the other hanging with your hands. But the stand also provides the opportunity for hanging a punching bag and chin railing, which provides more training opportunities. In addition, it is good to hang TRX on the rig.

Length: 410 cm
 Width: 170 cm
 Height: 229 cm



Equipment for functional fitness, calisthenics and strongman

Gymleco also has equipment for more than just traditional fitness and strength equipment. Trends that have emerged in recent years are among others functional fitness, calisthenics and strongman training. Strongman is a discipline in strength sports that focuses on functional strength. Instead of traditional bumper plates and barbells, they use among other things, cars, and tires as equipment. Calisthenics is a combination between gymnastics and parkour where body weight is used. Gymleco has for several years chosen to sponsor the various competitions in this area of training. All of the equipment is specifically designed and unique for the sport.

Read more about our products on our website:
www.gymleco.com



Farmers Walk with handles
Art.nr: 666

Robust and really durable Farmers Walk. With generous space between the user's legs. Upward-angled weight holders for longer durability of the equipment.

Weight: 15 kg / piece



Conan Circle w/ weight stack
Art.nr: 665

Gymleco Conan Circle is a classical strongman equipment which is used by adding weight plates on it and carry around the weight in a circulating motion.



Prowler Sled 50 kg
Art.nr: 685

Gymleco's Prowler Sled is one of the best tools for developing strength throughout the body. It combines the training of strength and endurance of legs, waist and arms.

Length: 121 cm
 Width: 98 cm
 Height: 154 cm



Rack for Bumper Plates / Slamballs
Art.nr: 896

Picture shows the original racksize. You can add tiers with shelves that makes it possible to store your kettlebells or other small equipment.

Length: 120 cm
 Width: 40 cm
 Height: 108 - 164 cm

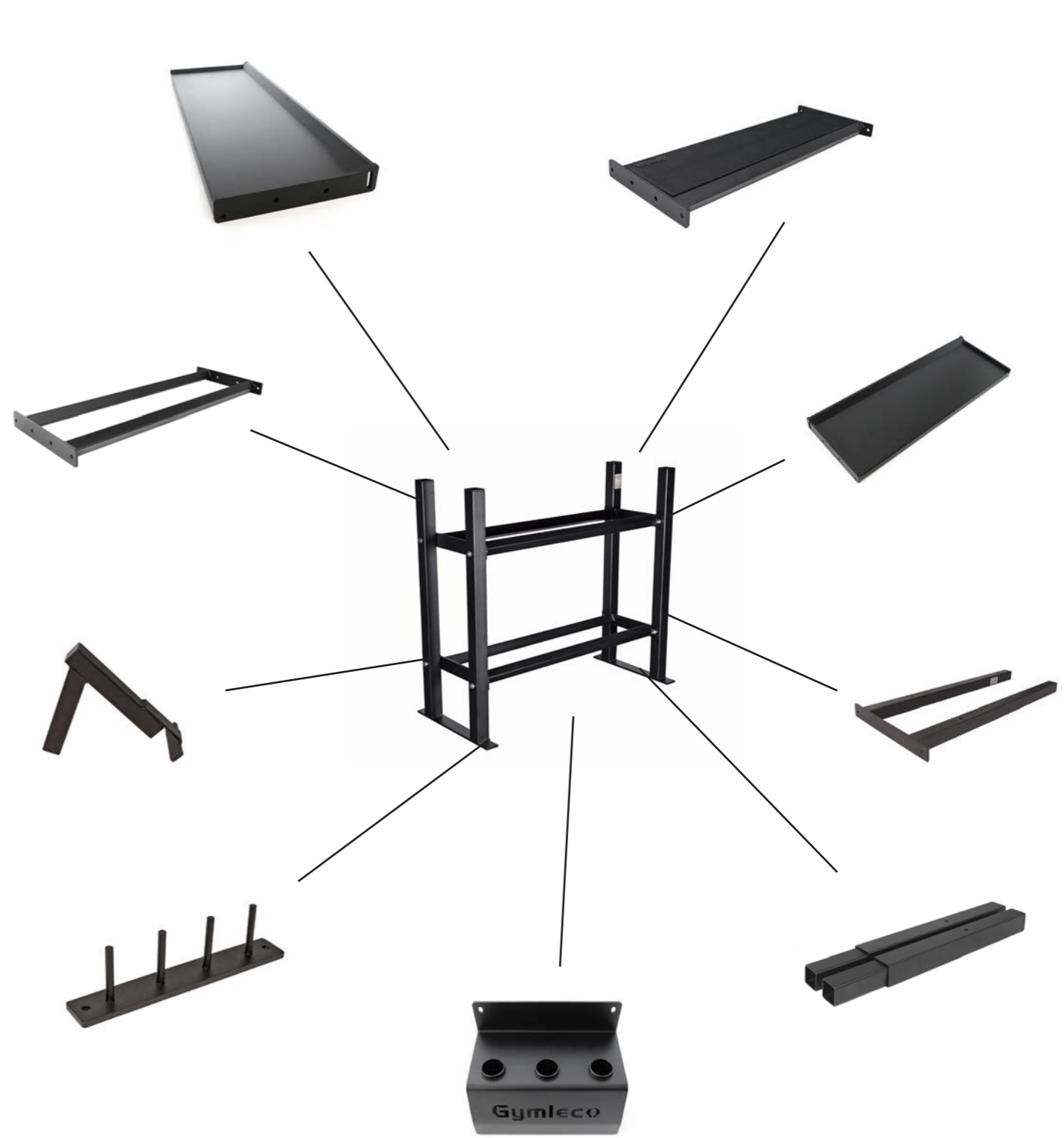

Build your Gymleco rack according to your wishes and conditions at the gym

You can customize this Gymleco rack completely to your needs. Build three shelves if you want to fit a lot on a small area. Build on the width if you have a lot of equipment and want everything gathered in one place for ease of use. Mix different types of shelves to make sure that all your equipment has a place on the scaffold. Add an accessory holder and add an accessory holder and a barbell rack to get up your equipment that otherwise just ends up on the floor.

Contact us and we will help you plan the best solution and give you a quote



Chalk Bowl / Stand
Art.nr: 692

A compact and smart designed standing bowl for storing chalk blocks or powder. This Gymleco Standing Bowl for chalk is perfect for commercial gyms and training boxes.

Push-up Bars
Art.nr: 621



These high-quality Gymleco Parallettes, or so-called Push-up Bars are used in calisthenics and help you get more power in exercises that strengthen the arms, shoulders and chest.

Length: 126 cm
Height: 122 cm
Width: 30 cm
Weight: 12 kg

Barbell Lifter / Barbell Jack
Art.nr: 898



Gymleco's barbell lifter is a tool that makes it easy to change weights during heavy weight training. Just roll over the bar with weights on and lift it up a few cm to change weights.

Length: 126 cm
Height: 122 cm
Width: 30 cm
Weight: 12 kg

Barbell Lift Mini
Art.nr: 899



Gymleco's barbell lift (mini) is a tool that makes it easy to change weights during heavy weight training. Just roll over the bar with weights on and lift it up a few cm to change weights.

Stock Press, Single Grip, 32 kg
Art.nr: 668

One grip Stock Press is used in the gym for strongman training. See article #669 Gymleco Stock Press för double grip and 50 kg. Used with international weights with 50mm in hole diameter.

Length: 177,5 cm
Grip: 30 mm



Stock Press, Double Grip, 50 kg
Art.nr: 669

Used in the gym for strongman training. See article #668 Stock Press för one grip and 32 kg. Used with international weights with 50mm in hole diameter.

Length: 177,5 cm
Grip: 30 mm



Punching Bag
Art.nr: N214

Designed to hold hard boxing training at the gym. The bag is 130 cm long which gives you the opportunity to turn on the bag thanks to the length.

Width: 40 cm
Length: 130 cm
Weight: 40 kg



Standing Punching Bag
Art.nr: N224

This standing punching bag is in a durable PVC material with a filling in foam plastic. Sand is not included.

Diameter: 41 / 60 cm
Height: 178 cm





Power Tyre, three sizes
Art.nr: N59

An old tractor tire has long been a popular tool in so-called hardcore strongman training. Now Gymleco has developed a custom tire that is a perfect training tool for you who are looking for variation in the training sessions. This one is perfect at the indoor gym.

These training tires are available in three sizes:
Green: D87/40x25cm - 40kg
Blue: D103/50x31cm - 60kg
Red: D122/60x34cm - 80kg



Strongman Sand Bags, XS - XL
Art.nr: 869

Gymleco's Strongman Sandbags is an excellent equipment for both strongman, functional fitness and other free weight training. A good choice instead of atlas stones and slamballs. The sandbags are good for exercises such as front squats and sandbag carries. The bag is closed with the included rings, ball and cable tie. Note that the bag is not delivered with sand. We recommend filling the bag with ordinary fine-grained sand.

Available in sizes 30 kg, 45 kg, 65 kg, 85 kg, 115 kg

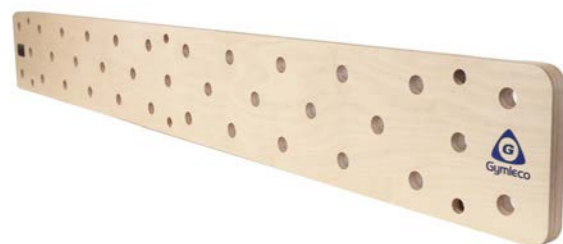

Peg Board
Art.nr: 611

Gymleco's Peg Board is designed and manufactured with the absolute finest quality. It has a total of 35 holes and is made of strong wooden material. Training in a pegboard is extremely heavy and good for your grip strength, as you hang your hands on two sticks and move forward, up and down with them.

Two sticks of oak are included
Measures: 2420x300 mm

Soft Drop Boxes
Art.nr: A-756013

Crash Pads are an innovative piece of equipment which quickly got popular in weight lifting. The pads are used in weight lifting and functional training with the purpose of minimizing the sound but also lower the impact on the equipment when you drop your barbell with weights.

Length: 75 cm
Width: 60 cm
Height: 13 cm
Weight: 7,8 kg



Podium for Atlas Stones, 3 heights
Art.nr: 867

Gymleco's Podium for Atlas Stones are an essential part of your Strongman equipment. The podiums are robust and made of the highest quality to make sure that you can lift as heavy and as much as you'd like.

The podium is available in sizes 150 cm, 135 cm and 120 cm, but can also be ordered in other sizes



Weightlifting Podium
Art.nr: 890

Weightlifting Podium in the Gymleco brand. The middle part is plywood with grooved plastic surface for best grip. The middle part is surrounded by durable Everroll Elastic Tiles – rubber mat. The podium is also surrounded by a powder-coated metal frame.

Measures: 3000 x 2500 x 30 mm



www.gymleco.com
@gymleco