

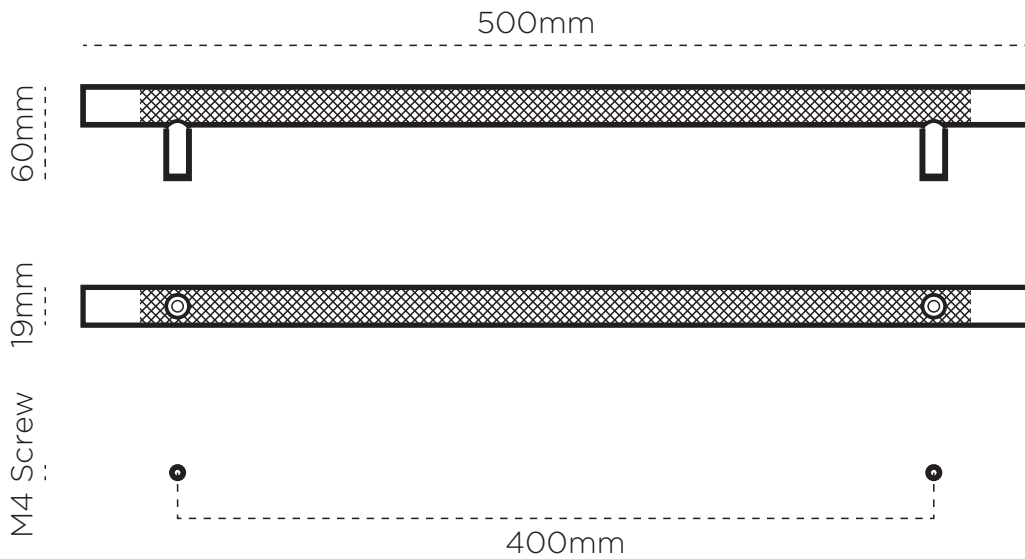





## HARDWARE | KINTORE APPLIANCE PULL

TECH SPEC

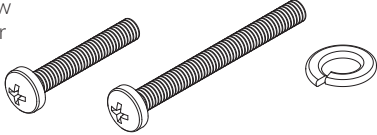
### SPECIFICATIONS



FINISH	SKU	FIXINGS ALSO INCLUDED
 Natural Brass	4041-US4	<p>2x M4 * 25mm screw 2x M4 * 40mm screw 2x M4 spring washer</p> 
 Matte Black	4041-US19	
 Brushed Nickel	4041-BN	
 Matte White	4041-W	
 Bronze	4041-BR	

### CARE INSTRUCTIONS

Wipe with damp cloth and avoid using any chemicals.